

LG-C1

6/00

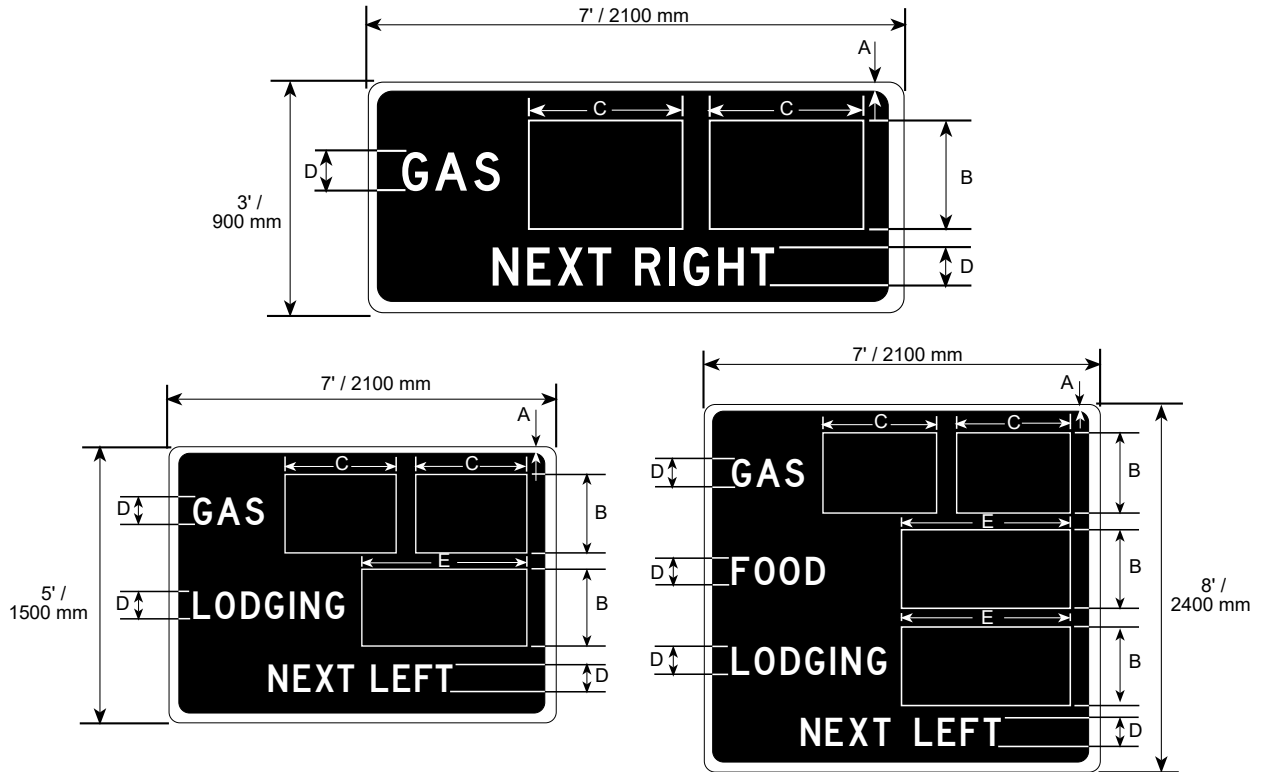

MINIMUM OF 3" BETWEEN BUSINESS SIGNS

DIMENSIONS (MILLIMETERS)				
A	B	C	D	E
25	450	600	150D	900

DIMENSIONS (INCHES)				
A	B	C	D	E
1	18	24	6D	36

TYPICAL SIGN (GAS, FOOD, LODGING) LAYOUTS FOR CONVENTIONAL ROADS.

GAS, FOOD, AND LODGING BACKGROUNDS SHALL BE BLUE REFLECTIVE SHEETING. LEGEND SHALL BE WHITE REFLECTIVE SHEETING.

LG-C2

6/00

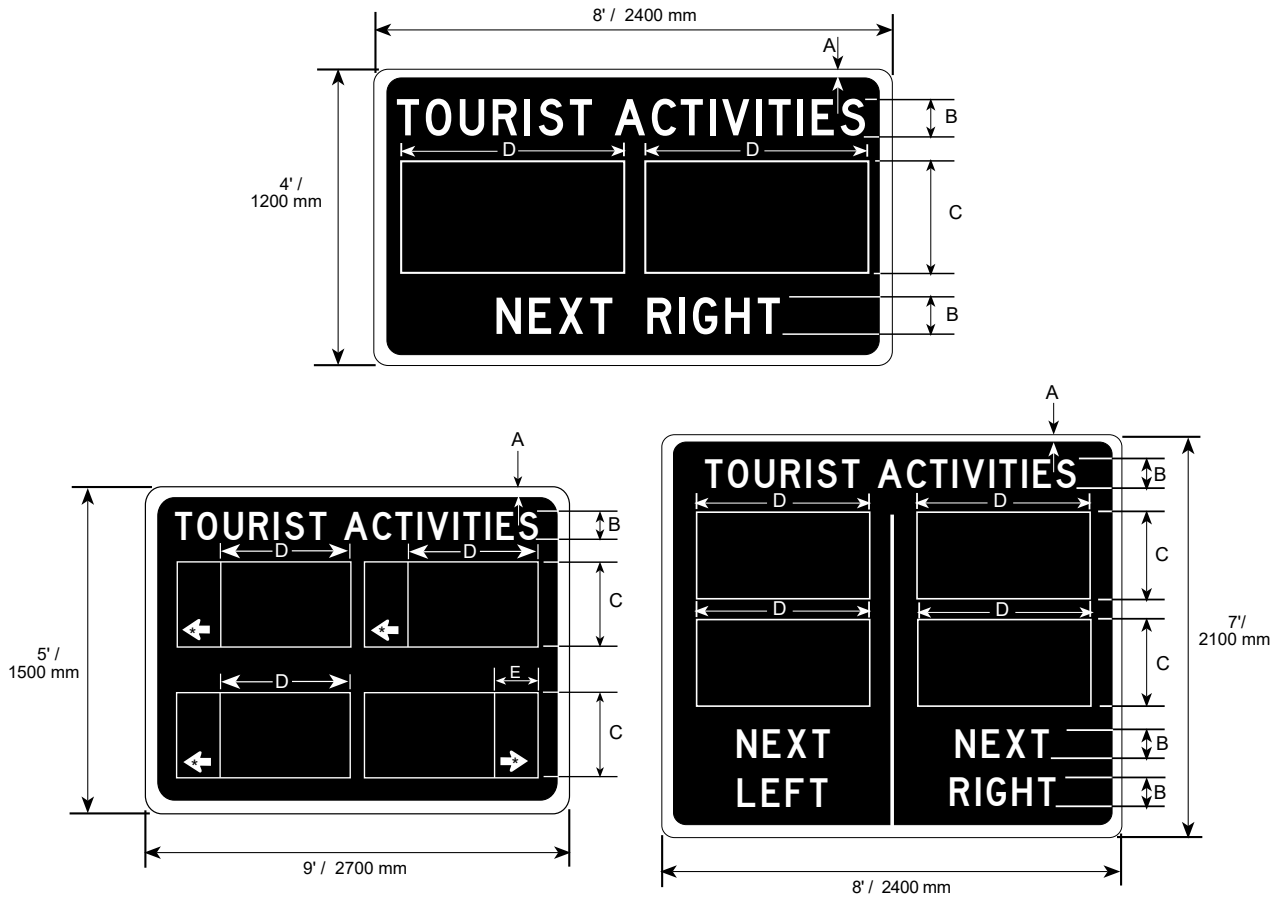

* ARROWS ARE STANDARD 6" X 9"
MINIMUM OF 3" BETWEEN BUSINESS SIGNS

DIMENSIONS (MILLIMETERS)				
A	B	C	D	E
25	150D	450	900	300

DIMENSIONS (INCHES)				
A	B	C	D	E
1	6D	18	36	12

TYPICAL SIGN (TOURIST ACTIVITIES) LAYOUTS FOR CONVENTIONAL ROADS.

TOURIST ACTIVITIES BACKGROUNDS SHALL BE BLUE REFLECTIVE SHEETING. LEGEND SHALL BE WHITE REFLECTIVE SHEETING.

LG-C3

6/00

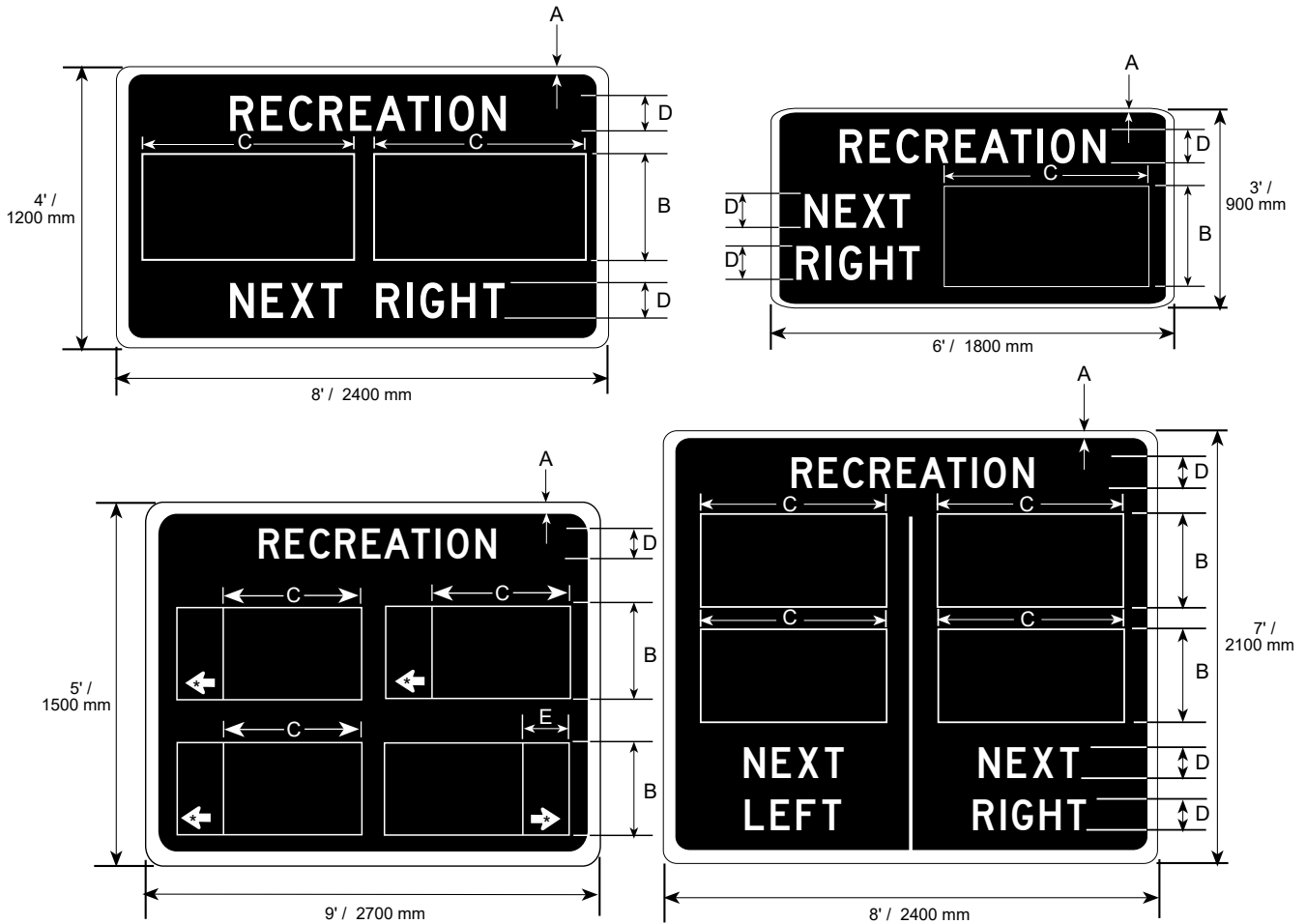

* ARROWS ARE STANDARD 6" X 9".
MINIMUM OF 3" BETWEEN BUSINESS SIGNS

DIMENSIONS (MILLIMETERS)				
A	B	C	D	E
25	450	900	150D	300

DIMENSIONS (INCHES)				
A	B	C	D	E
1	18	36	6D	12

TYPICAL SIGN (RECREATION) LAYOUTS FOR CONVENTIONAL ROADS.

RECREATION SIGN BACKGROUNDS SHALL BE BROWN REFLECTIVE SHEETING. LEGEND SHALL BE WHITE REFLECTIVE SHEETING.

LG-M1

5/06

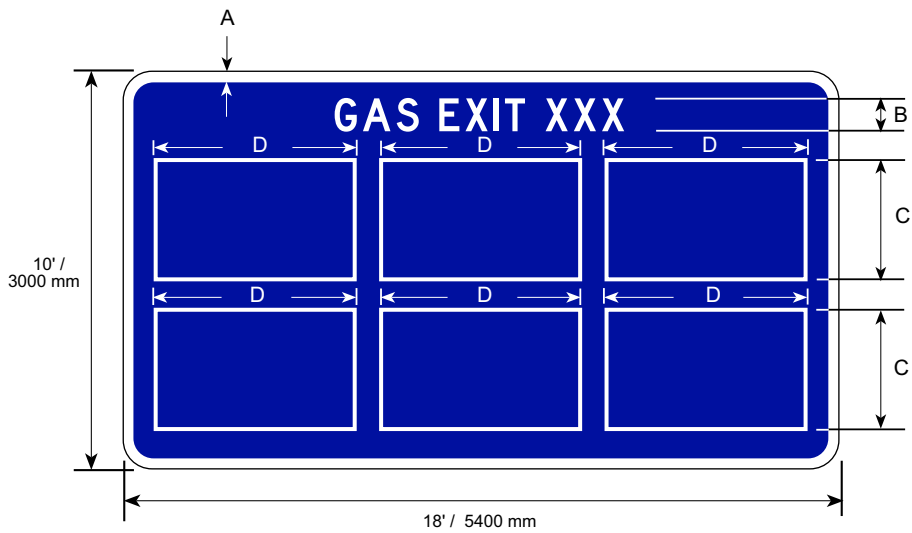
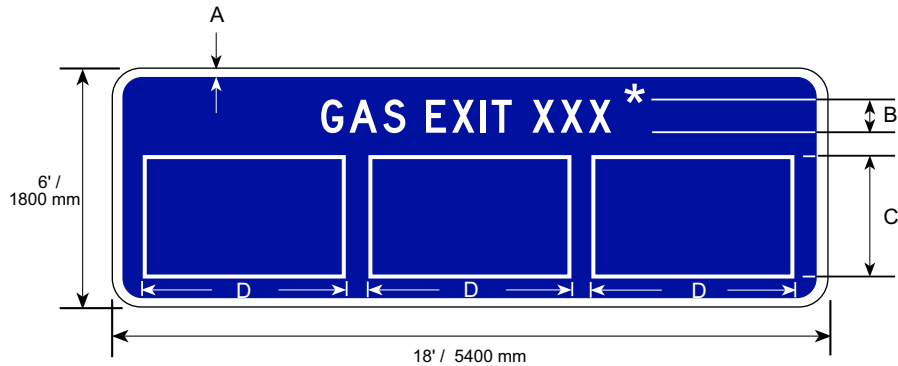

* FOR INTERCHANGES WITHOUT EXIT NUMBERS, USE “NEXT RIGHT”

DIMENSIONS (MILLIMETERS)			
A	B	C	D
38	250D	900	1500

DIMENSIONS (INCHES)			
A	B	C	D
1 1/2	10D	36	60

TYPICAL SIGN (GAS) LAYOUTS FOR FREEWAY OR EXPRESSWAY MAINLINE

COLORS

GAS BACKGROUNDS SHALL BE BLUE REFLECTIVE SHEETING
 LEGEND SHALL BE WHITE REFLECTIVE SHEETING

LG-M1A

5/06

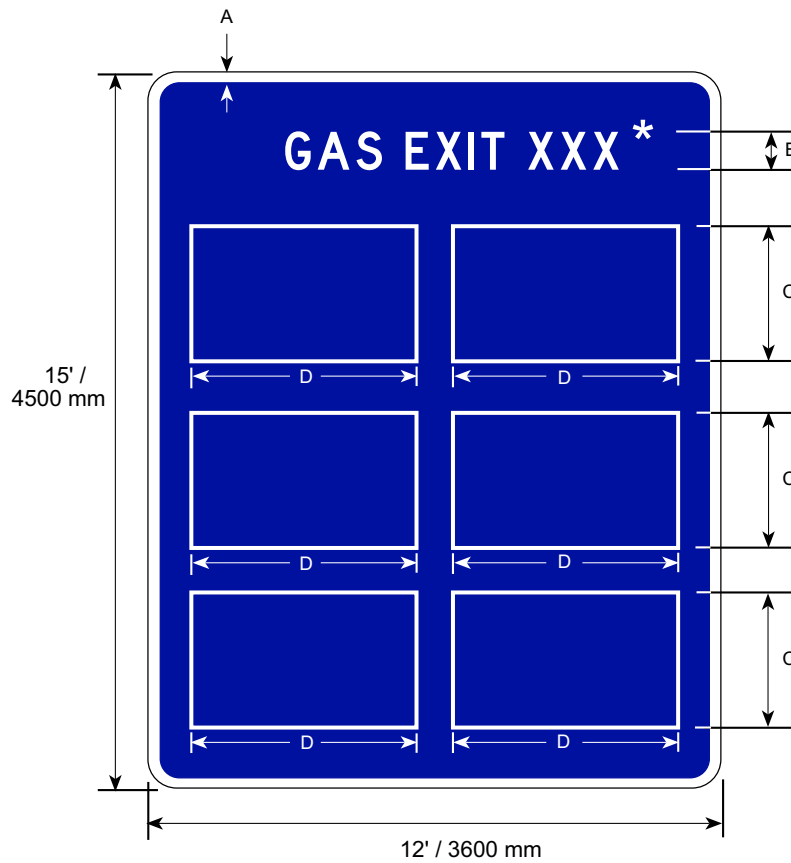

* FOR INTERCHANGES WITHOUT EXIT NUMBERS USE "NEXT RIGHT"

DIMENSIONS (MILLIMETERS)			
A	B	C	D
38	250D	900	1500

DIMENSIONS (INCHES)			
A	B	C	D
1 1/2	10D	36	60

TYPICAL SIGN (GAS) LAYOUTS FOR FREEWAY OR EXPRESSWAY MAINLINE

COLORS

GAS BACKGROUNDS SHALL BE BLUE REFLECTIVE SHEETING
 LEGEND SHALL BE WHITE REFLECTIVE SHEETING

LG-M2

11/97

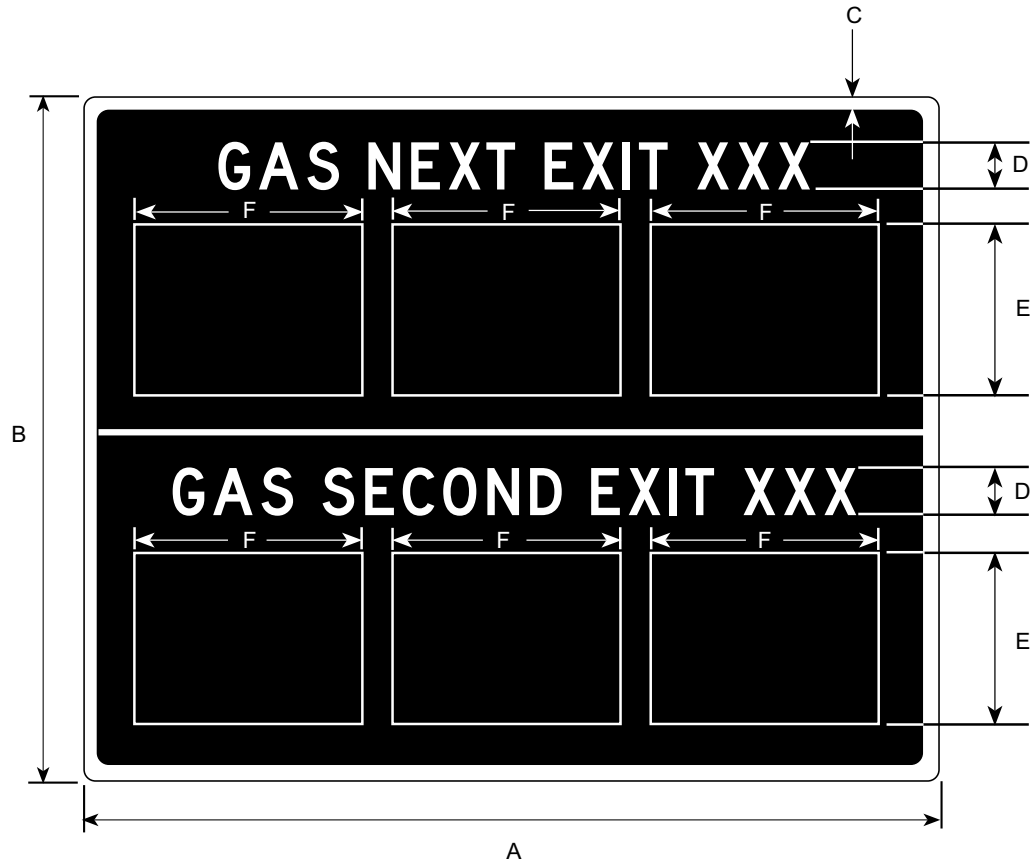

MINIMUM OF 3" BETWEEN BUSINESS SIGNS

DIMENSIONS (MILLIMETERS)					
A	B	C	D	E	F
4500	3600	38	250D	900	1200

DIMENSIONS (INCHES)					
A	B	C	D	E	F
180	144	1 1/2	10D	36	48

TYPICAL SIGN (GAS) LAYOUT FOR FREEWAY OR EXPRESSWAY MAINLINE

GAS BACKGROUND SHALL BE BLUE REFLECTIVE SHEETING. LEGEND SHALL BE WHITE REFLECTIVE SHEETING.

LG-M3

5/06

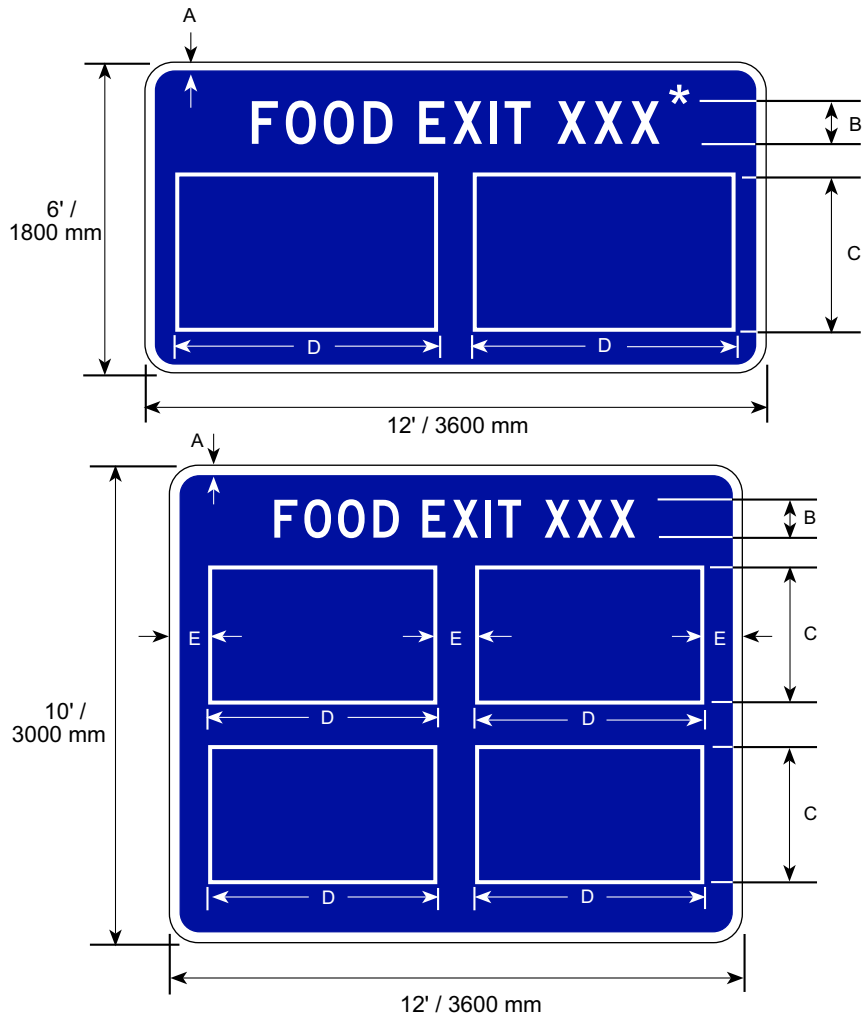

* FOR INTERCHANGES WITHOUT EXIT NUMBERS, USE "NEXT RIGHT"

DIMENSIONS (MILLIMETERS)				
A	B	C	D	E
38	250D	900	1500	200

DIMENSIONS (INCHES)				
A	B	C	D	E
1 1/2	10D	36	60	8

TYPICAL SIGN (FOOD) LAYOUTS FOR FREEWAY OR EXPRESSWAY MAINLINE

COLORS

FOOD BACKGROUNDS SHALL BE BLUE REFLECTIVE SHEETING
 LEGEND SHALL BE WHITE REFLECTIVE SHEETING

LG-M3A

5/06

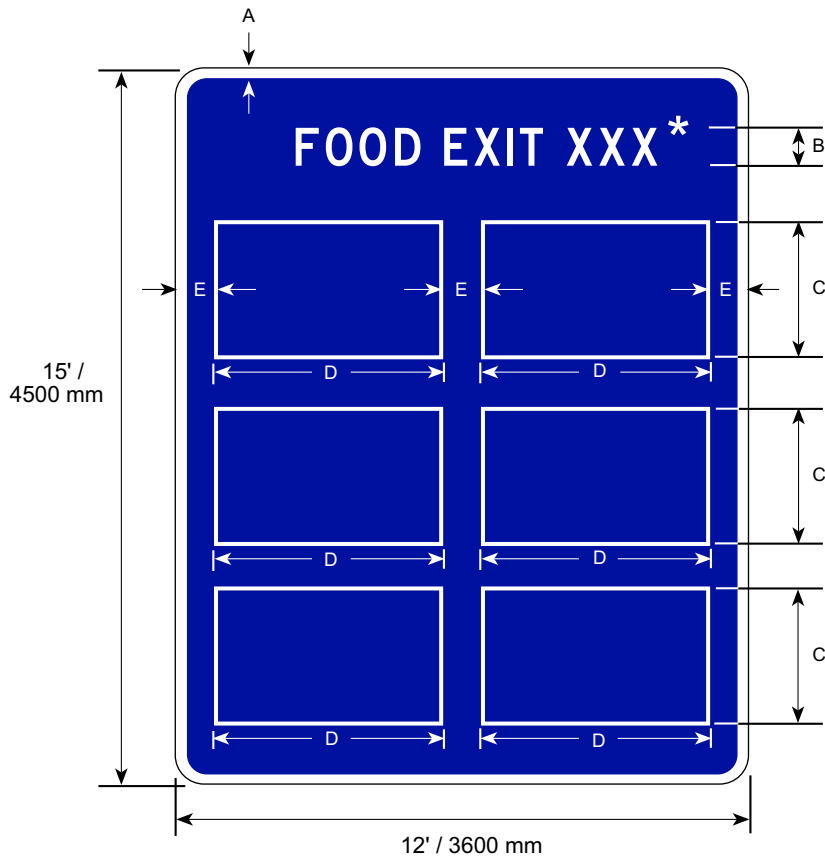

* FOR INTERCHANGES WITHOUT EXIT NUMBERS USE "NEXT RIGHT"

DIMENSIONS (MILLIMETERS)				
A	B	C	D	E
38	250D	900	1500	200

DIMENSIONS (INCHES)				
A	B	C	D	E
1 1/2	10D	36	60	8

TYPICAL SIGN (FOOD) LAYOUTS FOR FREEWAY OR EXPRESSWAY MAINLINE

COLORS

FOOD BACKGROUNDS SHALL BE BLUE REFLECTIVE SHEETING
 LEGEND SHALL BE WHITE REFLECTIVE SHEETING

LG-M4

11/97

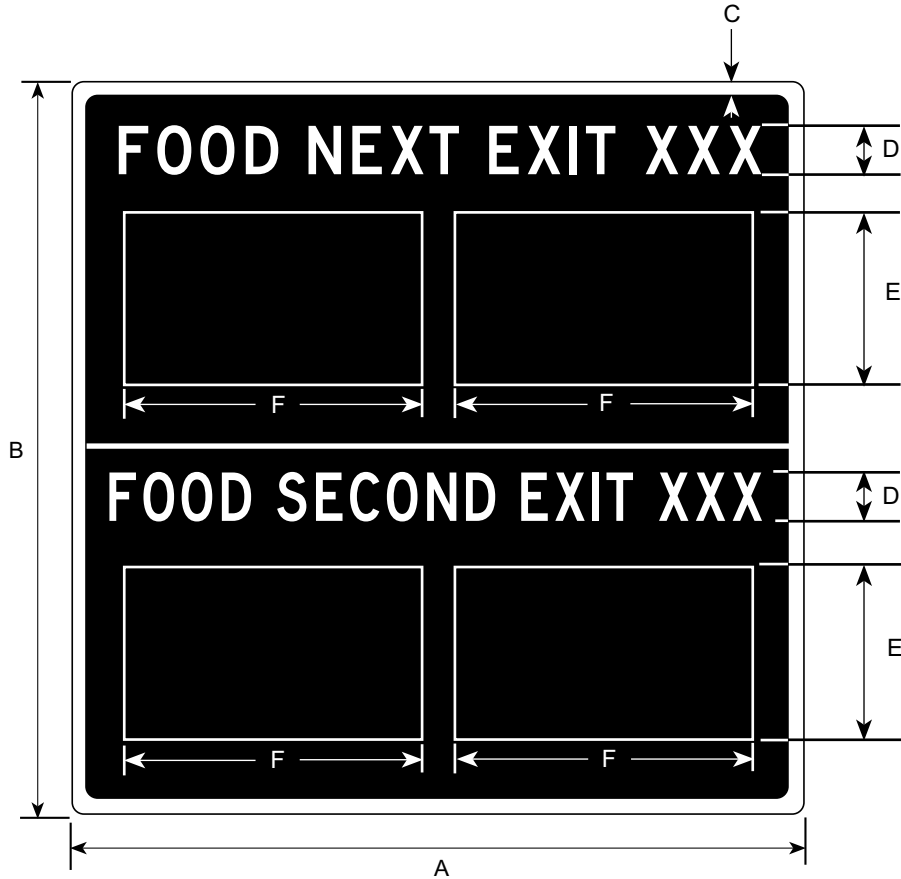

MINIMUM OF 3" BETWEEN BUSINESS SIGNS

DIMENSIONS (MILLIMETERS)					
A	B	C	D	E	F
4200	3600	38	250D	900	1500

DIMENSIONS (INCHES)					
A	B	C	D	E	F
168	144	1 1/2	10D	36	60

TYPICAL SIGN (FOOD) LAYOUT FOR FREEWAY AND EXPRESSWAY MAINLINE.

FOOD BACKGROUNDS SHALL BE BLUE REFLECTIVE SHEETING. LEGEND SHALL BE WHITE REFLECTIVE SHEETING.

LG-M5

5/06

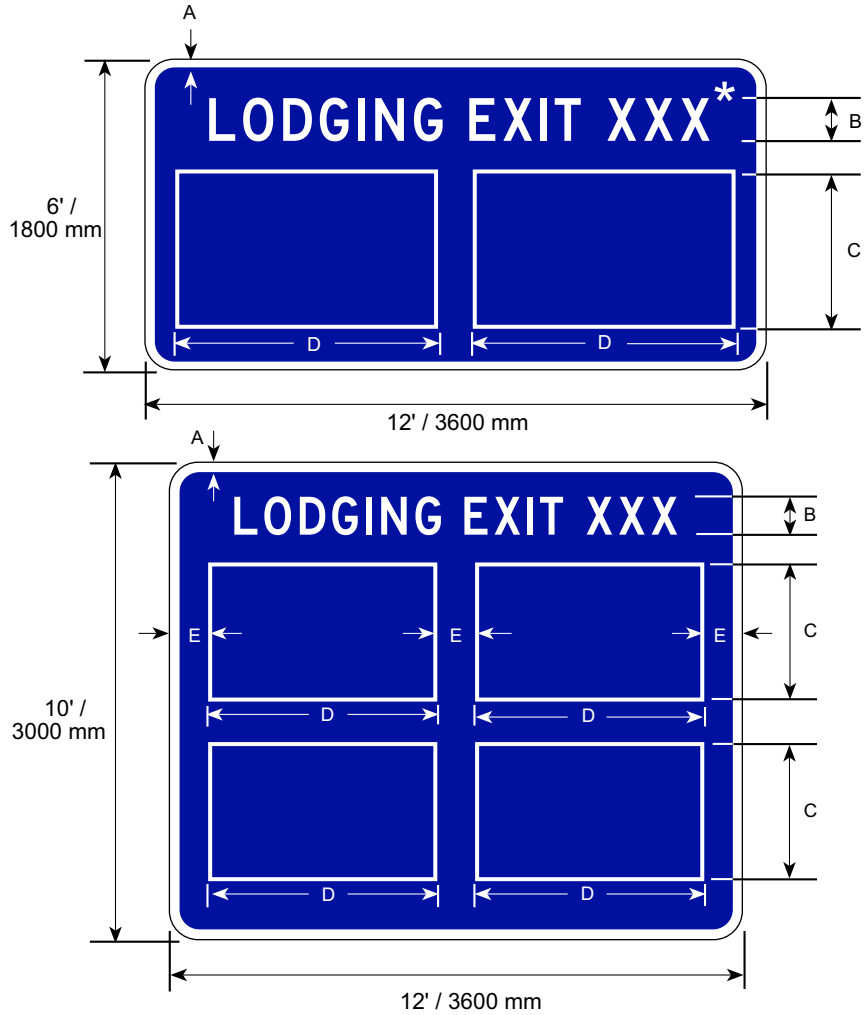

* FOR INTERCHANGES WITHOUT EXIT NUMBERS, USE "NEXT RIGHT"

DIMENSIONS (MILLIMETERS)				
A	B	C	D	E
38	250D	900	1500	200

DIMENSIONS (INCHES)				
A	B	C	D	E
1 1/2	10D	36	60	8

TYPICAL SIGN (LODGING) LAYOUTS FOR FREEWAY OR EXPRESSWAY MAINLINE

COLORS

FOOD BACKGROUNDS SHALL BE BLUE REFLECTIVE SHEETING
 LEGEND SHALL BE WHITE REFLECTIVE SHEETING

LG-M5A

5/06

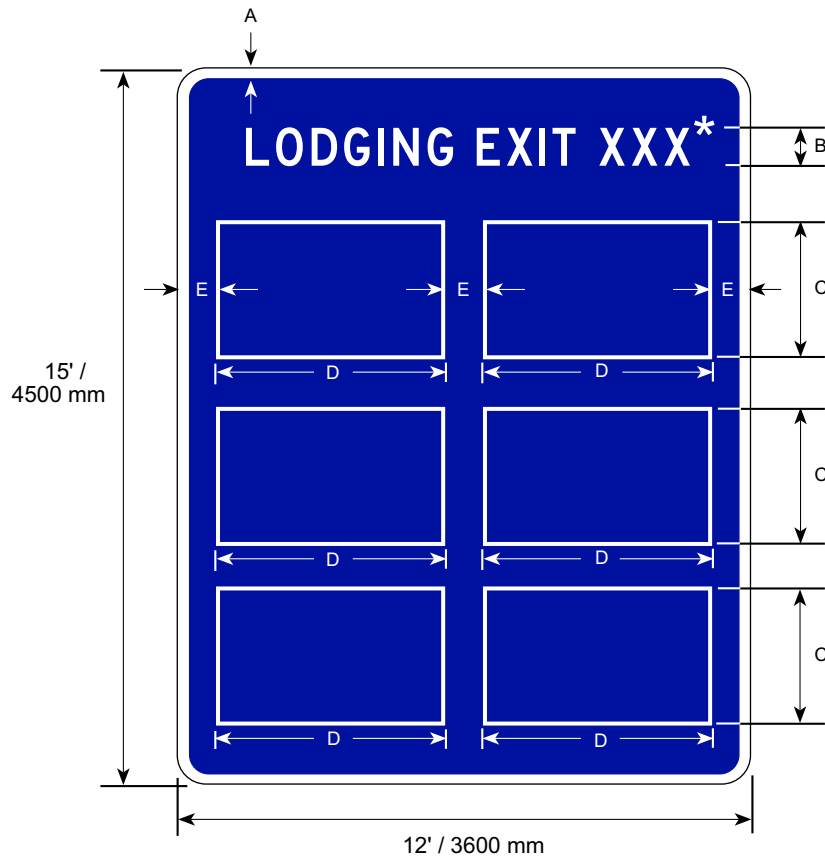

* FOR INTERCHANGES WITHOUT EXIT NUMBERS USE "NEXT RIGHT"

DIMENSIONS (MILLIMETERS)				
A	B	C	D	E
38	250D	900	1500	200

DIMENSIONS (INCHES)				
A	B	C	D	E
1 1/2	10D	36	60	8

TYPICAL SIGN (LODGING) LAYOUTS FOR FREEWAY OR EXPRESSWAY MAINLINE

COLORS

FOOD BACKGROUNDS SHALL BE BLUE REFLECTIVE SHEETING
 LEGEND SHALL BE WHITE REFLECTIVE SHEETING

LG-M6

11/97

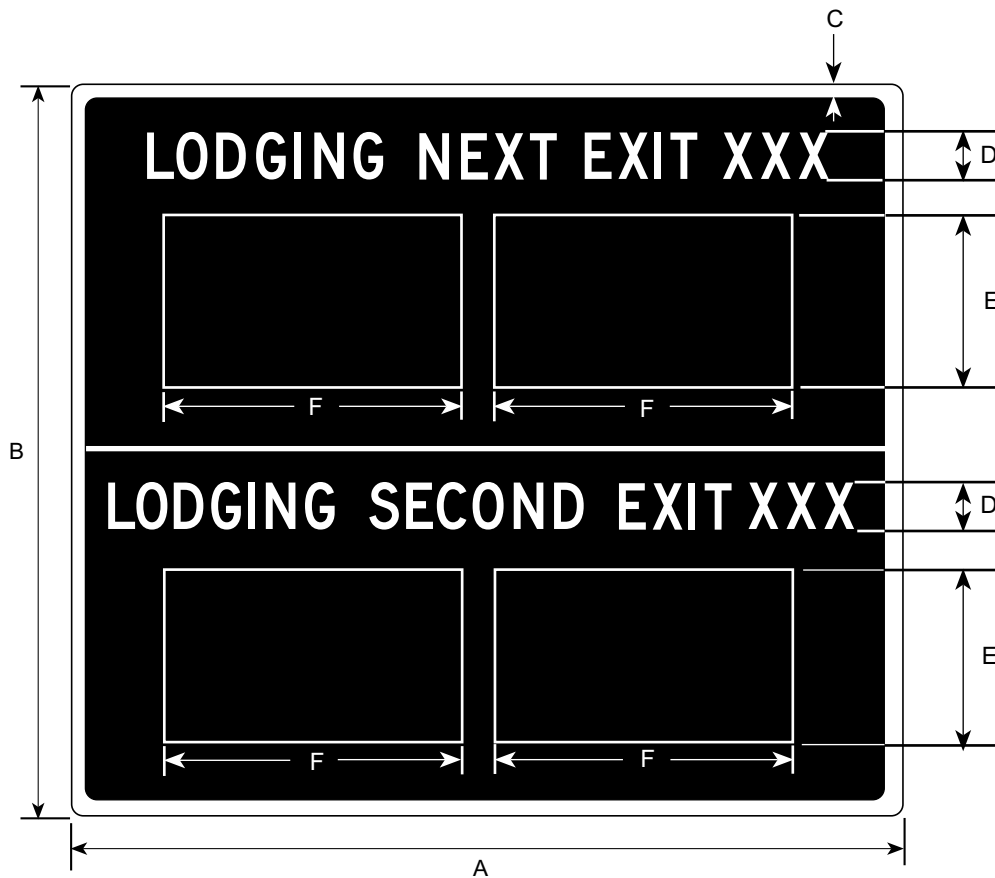

MINIMUM OF 3" BETWEEN BUSINESS SIGNS

DIMENSIONS (MILLIMETERS)					
A	B	C	D	E	F
5100	3600	38	250D	900	1500

DIMENSIONS (INCHES)					
A	B	C	D	E	F
204	144	1 1/2	10D	36	60

TYPICAL SIGN (LODGING) LAYOUT FOR FREEWAY OR EXPRESSWAY MAINLINE.

LODGING BACKGROUNDS SHALL BE BLUE REFLECTIVE SHEETING.
LEGEND SHALL BE WHITE REFLECTIVE SHEETING.

LG-M7

6/00

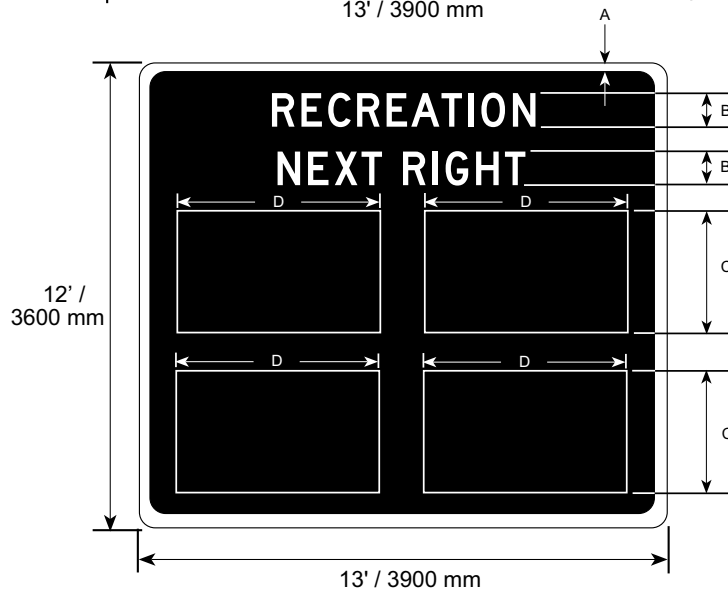
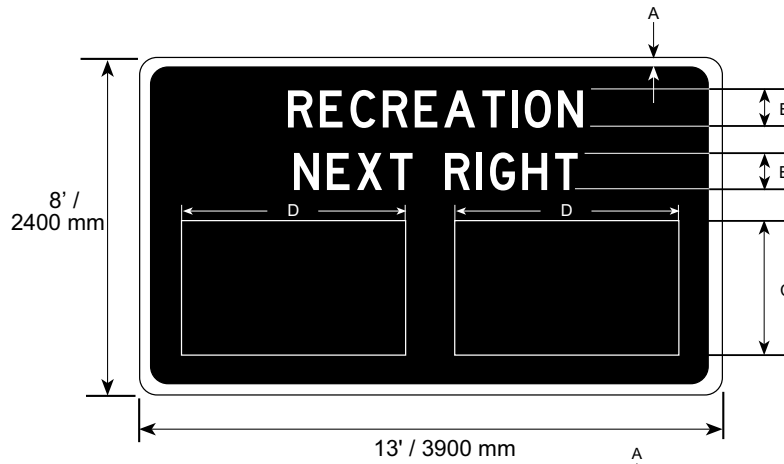

MINIMUM OF 3" BETWEEN BUSINESS SIGNS

DIMENSIONS (MILLIMETERS)			
A	B	C	D
38	250D	900	1500

DIMENSIONS (INCHES)			
A	B	C	D
1 1/2	10D	36	60

RECREATION BACKGROUNDS SHALL BE BROWN REFLECTIVE SHEETING.
LEGEND SHALL BE WHITE REFLECTIVE SHEETING.

LG-M8

11/97

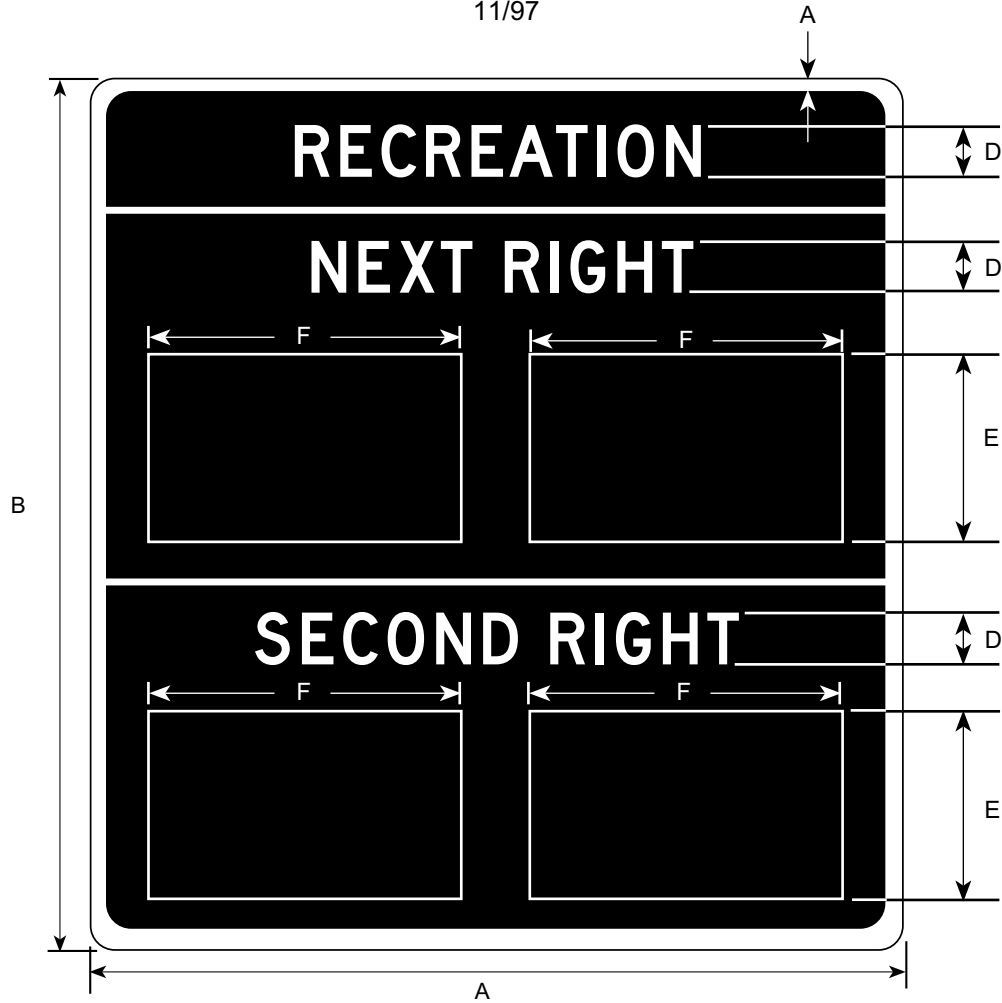

MINIMUM OF 3" BETWEEN BUSINESS SIGNS

DIMENSIONS (MILLIMETERS)					
A	B	C	D	E	F
3900	4200	38	250D	900	1500

DIMENSIONS (INCHES)					
A	B	C	D	E	F
156	168	1 1/2	10D	36	60

RECREATION BACKGROUNDS SHALL BE BROWN REFLECTIVE SHEETING.
 LEGEND SHALL BE WHITE REFLECTIVE SHEETING.

LG-M9

506

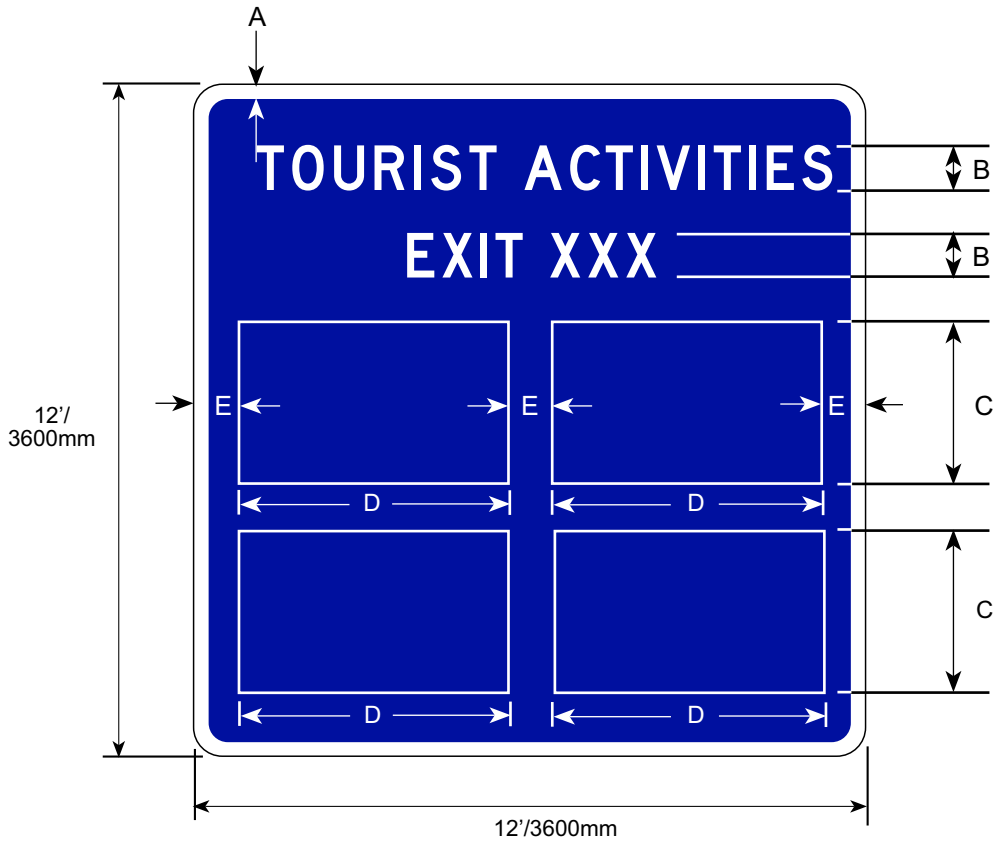

FOR INTERCHANGES WITHOUT EXIT NUMBERS, USE "NEXT RIGHT"

DIMENSIONS (MILLIMETERS)				
A	B	C	D	E
38	250D	900	1500	200

DIMENSIONS (INCHES)				
A	B	C	D	E
1 1/2	10D	36	60	8

TYPICAL SIGN (TOURIST ACTIVITIES) LAYOUT FOR FREEWAY OR EXPRESSWAY MAINLINE

COLORS

TOURIST ACTIVITIES BACKGROUNDS SHALL BE BLUE REFLECTIVE SHEETING
LEGEND SHALL BE WHITE REFLECTIVE SHEETING.

LG-M9A

5/06

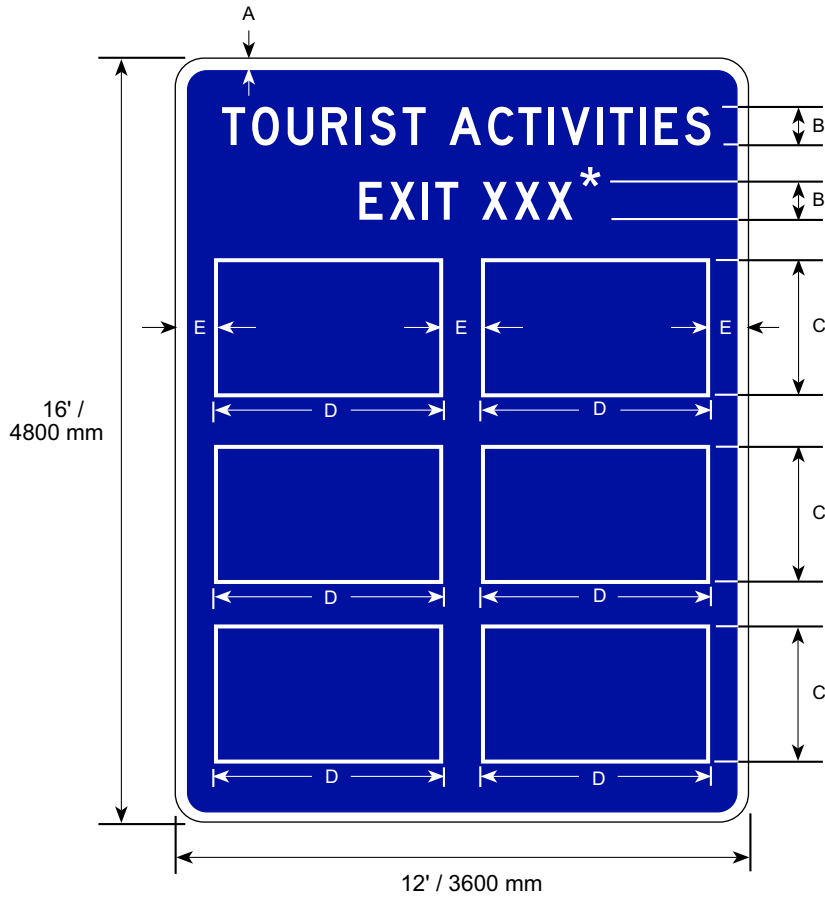

* FOR INTERCHANGES WITHOUT EXIT NUMBERS USE "NEXT RIGHT"

DIMENSIONS (MILLIMETERS)				
A	B	C	D	E
38	250D	900	1500	200

DIMENSIONS (INCHES)				
A	B	C	D	E
1 1/2	10D	36	60	8

TYPICAL SIGN (TOURIST ACTIVITIES) LAYOUTS FOR
FREEWAY OR EXPRESSWAY MAINLINE

COLORS

FOOD BACKGROUNDS SHALL BE BLUE REFLECTIVE SHEETING
LEGEND SHALL BE WHITE REFLECTIVE SHEETING

LG-M10

11/97

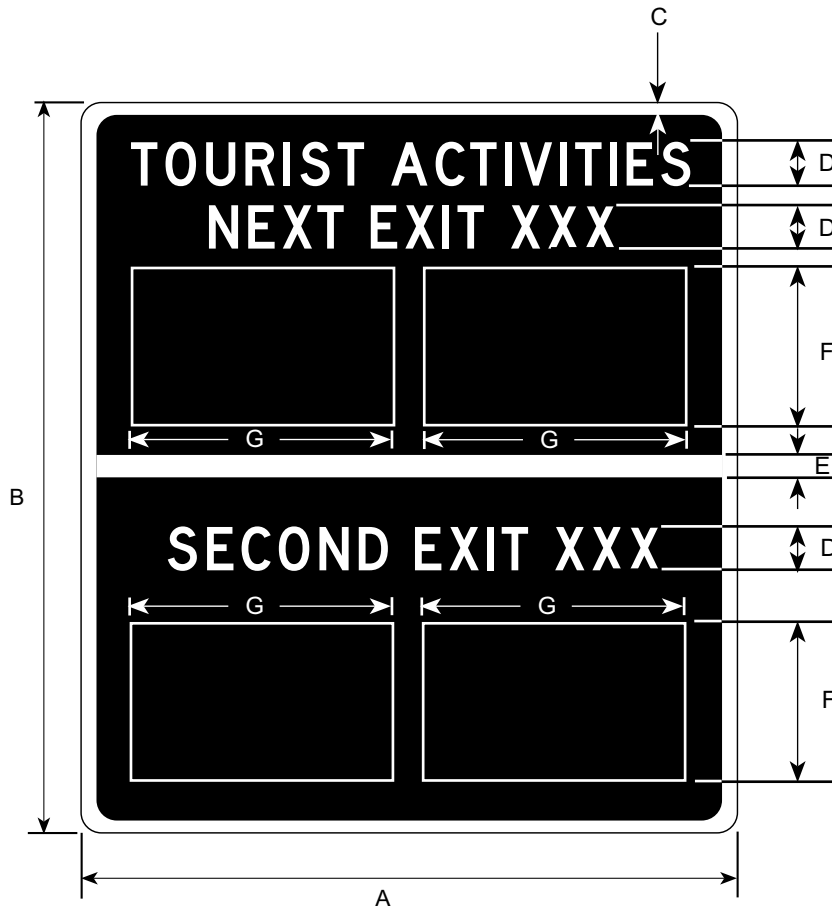

MINIMUM OF 3" BETWEEN BUSINESS SIGNS

DIMENSIONS (MILLIMETERS)						
A	B	C	D	E	F	G
3900	4200	38	250D	50	900	1500

DIMENSIONS (INCHES)						
A	B	C	D	E	F	G
156	168	1 1/2	10D	2	36	60

TYPICAL SIGN (TOURIST ACTIVITIES) LAYOUT FOR FREEWAY AND EXPRESSWAY MAINLINE.

TOURIST ACTIVITIES BACKGROUNDS SHALL BE BLUE REFLECTIVE SHEETING. LEGEND SHALL BE WHITE REFLECTIVE SHEETING.

LG-R1

5/06

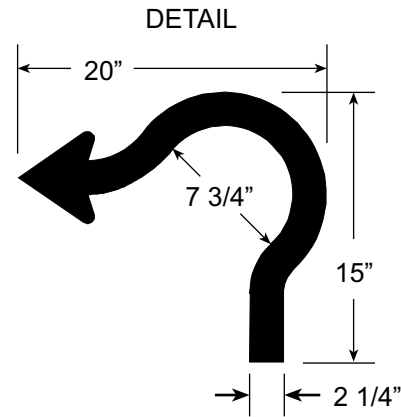
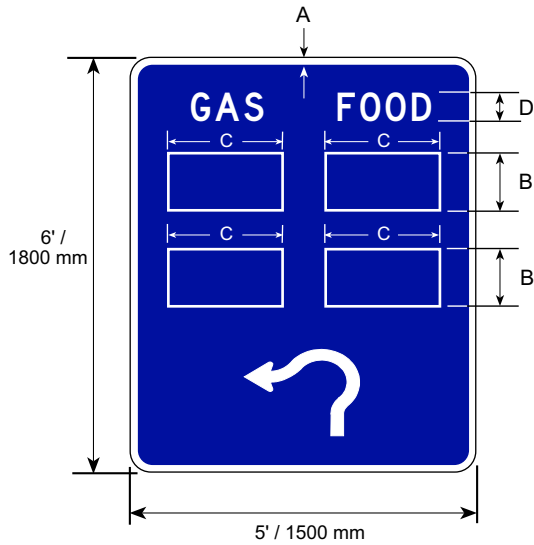
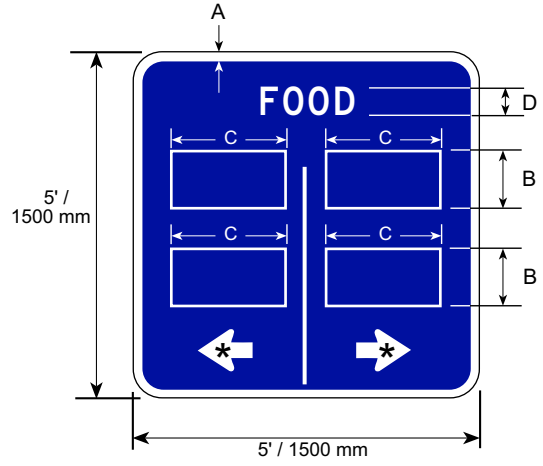
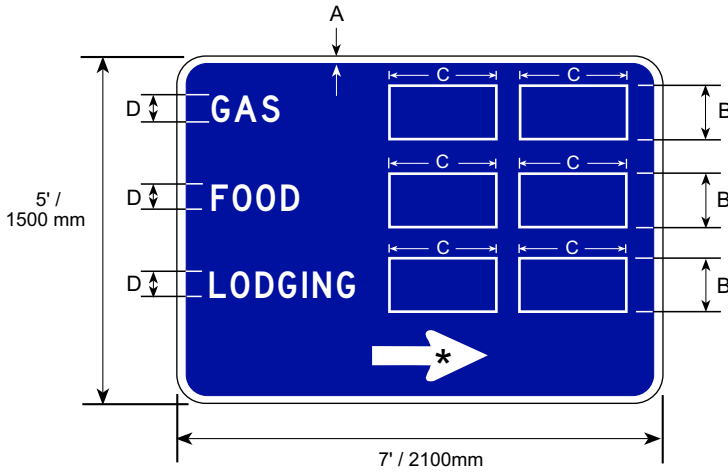

MINIMUM OF 3" BETWEEN BUSINESS SIGNS

* SEE APPENDIX FOR STANDARD ARROW DETAILS

DIMENSIONS (MM)			
A	B	C	D
25	300	600	150D

DIMENSIONS (INCHES)			
A	B	C	D
1	12	24	6D

TYPICAL SIGN (GAS, FOOD, LODGING) LAYOUTS FOR FREEWAY AND EXPRESSWAY RAMPS

GAS, FOOD, AND LODGING BACKGROUNDS SHALL BE BLUE REFLECTIVE SHEETING
 LEGEND SHALL BE WHITE REFLECTIVE SHEETING

LG-R2

2/98

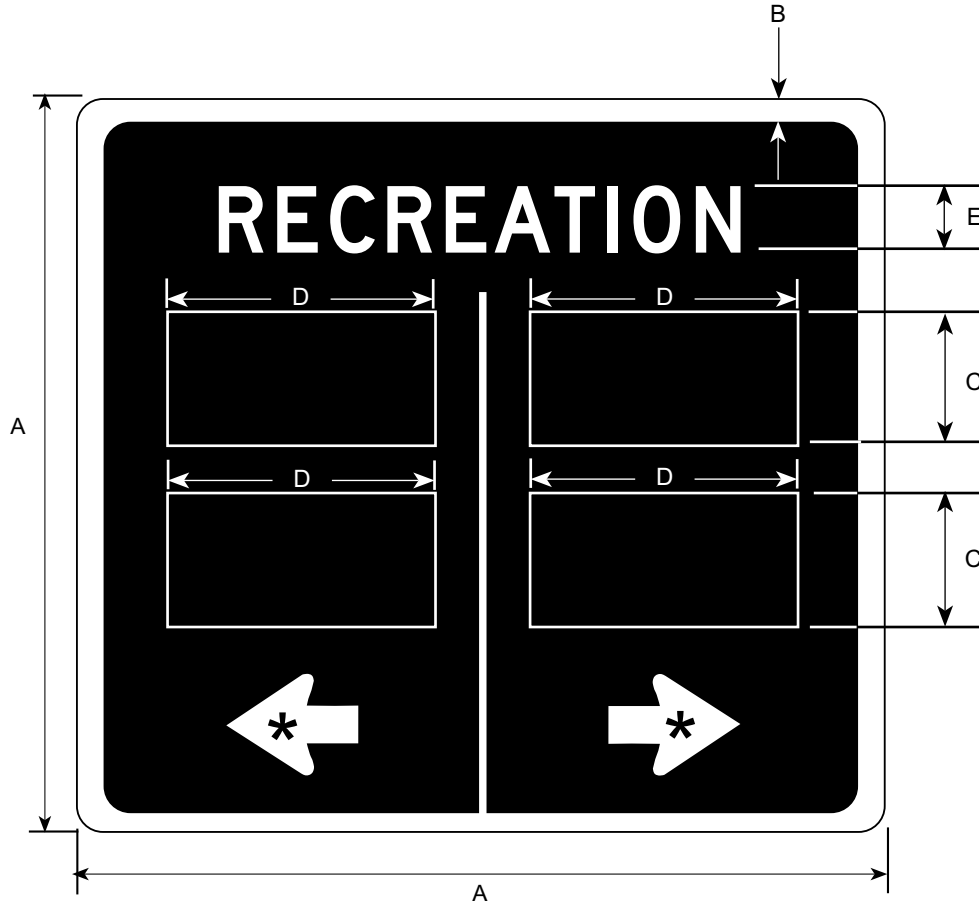

MINIMUM OF 3" BETWEEN BUSINESS SIGNS

* SEE APPENDIX FOR STANDARD ARROW DETAILS

DIMENSIONS (MILLIMETERS)				
A	B	C	D	E
1500	25	300	600	150D

DIMENSIONS (INCHES)				
A	B	C	D	E
60	1	12	24	6D

TYPICAL SIGN (RECREATION) LAYOUT FOR FREEWAY OR EXPRESSWAY RAMP

RECREATION BACKGROUND SHALL BE BROWN REFLECTIVE SHEETING.
LEGEND SHALL BE WHITE REFLECTIVE SHEETING.

LG-R3

2/98

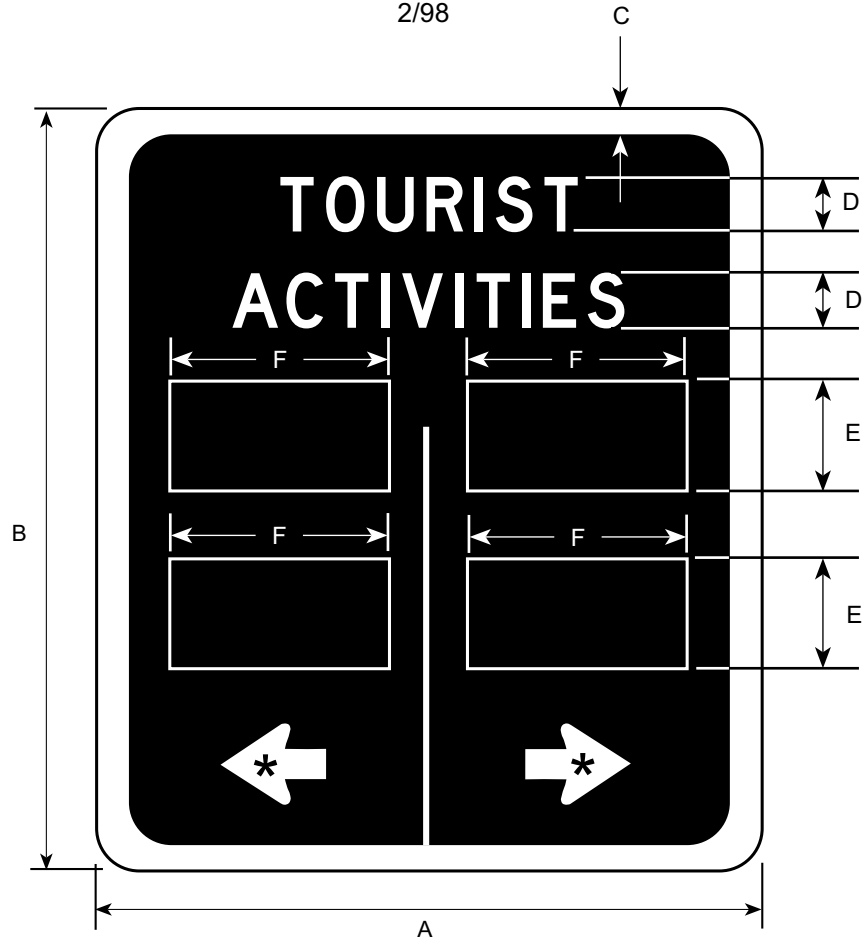

MINIMUM OF 3" BETWEEN BUSINESS SIGNS

* SEE APPENDIX FOR STANDARD ARROW DETAILS

DIMENSIONS (MILLIMETERS)					
A	B	C	D	E	F
1500	1800	25	150D	300	600

DIMENSIONS (INCHES)					
A	B	C	D	E	F
60	72	1	6D	12	24

TYPICAL SIGN (TOURIST ACTIVITIES) LAYOUT FOR FREEWAY OR EXPRESSWAY RAMPS

TOURIST ACTIVITIES BACKGROUND SHALL BE BLUE REFLECTIVE SHEETING. LEGEND SHALL BE WHITE REFLECTIVE SHEETING.

LG-R4

5/06

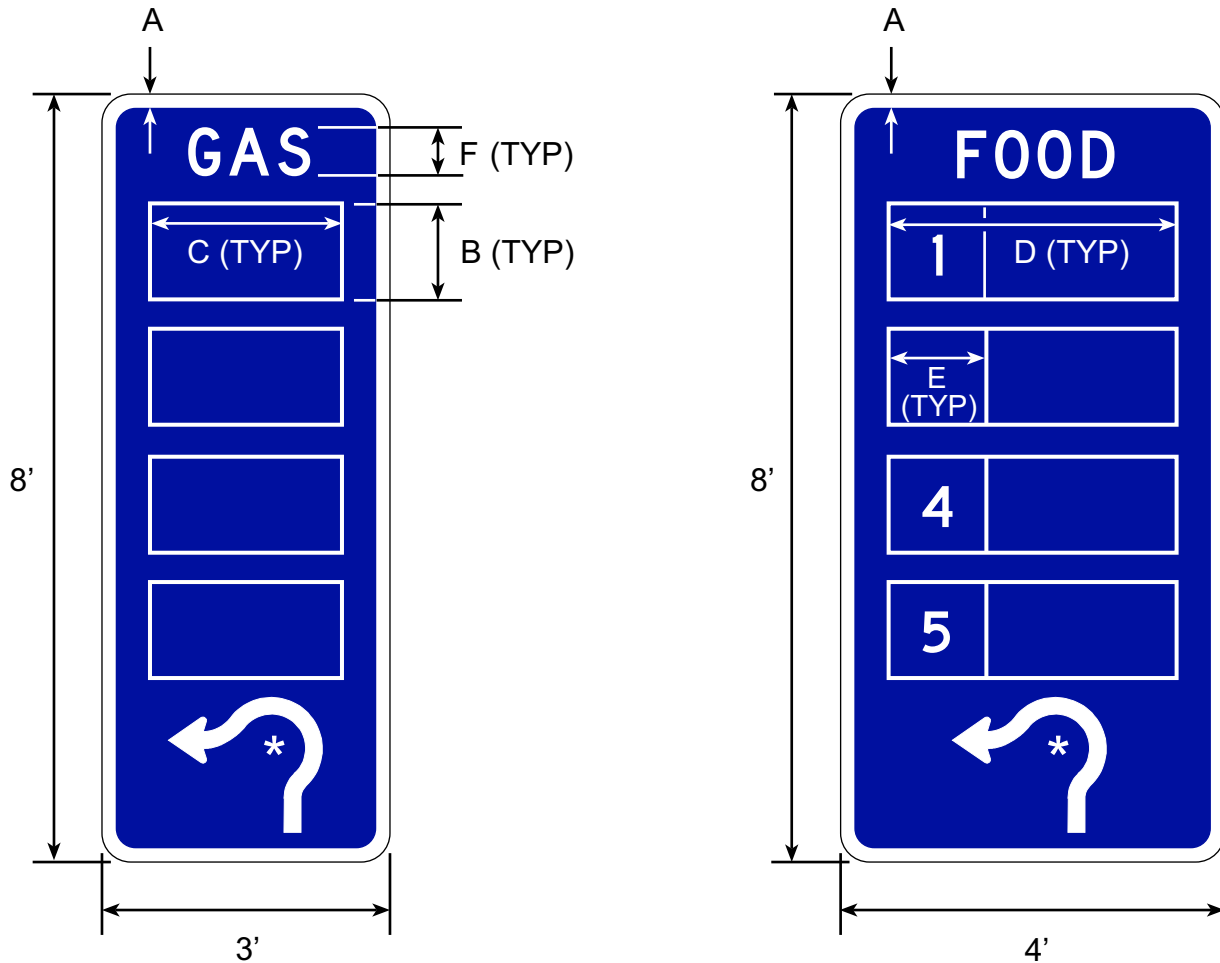

* SEE APPENDIX FOR STANDARD ARROW DETAILS
SEE LG-R1 FOR ARROW DIMENSIONS

DIMENSIONS (MILLIMETERS)					
A	B	C	D	E	F
25	300	600	900	300	150D

DIMENSIONS (INCHES)					
A	B	C	D	E	F
1	12	24	36	12	6D

TYPICAL SIGN (GAS, FOOD, LODGING) LAYOUTS FOR FREEWAY AND EXPRESSWAY RAMPS HAVING A ROUNDABOUT

GAS, FOOD, AND LODGING BACKGROUNDS SHALL BE BLUE REFLECTIVE SHEETING
LEGEND SHALL BE WHITE REFLECTIVE SHEETING