

# D1-101 & D1-201 & D1-301

10/97

## D1-101

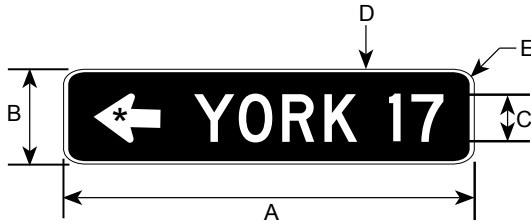

## D1-201

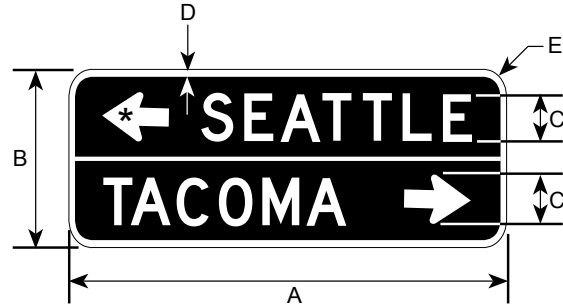

## D1-301

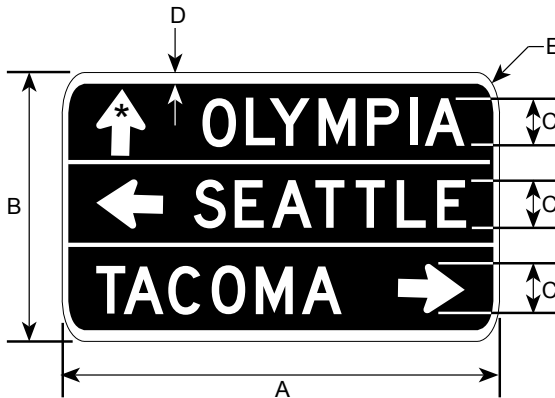

\* SEE APPENDIX FOR STANDARD DETAILS

SERIES D LETTERS ARE STANDARD.  
SERIES C MAY BE USED AS A MINIMUM.

DELETE SEPARATION BORDER WHEN  
DESTINATIONS ARE IN SAME DIRECTIONS.

DIMENSIONS (MILLIMETERS)						
SIGN CODE	MESSAGE LINES	A	B	C	D	E
D1-101	1	VAR	300	150D	19	38
D1-201	2	VAR	600	150D	19	38
D1-301	3	VAR	900	150D	19	38

DIMENSIONS (INCHES)						
SIGN CODE	MESSAGE LINES	A	B	C	D	E
D1-101	1	VAR	12	6D	3/4	1 1/2
D1-201	2	VAR	24	6D	3/4	1 1/2
D1-301	3	VAR	36	6D	3/4	1 1/2

## COLORS

LEGEND — WHITE (REFL)  
BACKGROUND — GREEN (REFL)

# D1-401 & D1-501

4/03

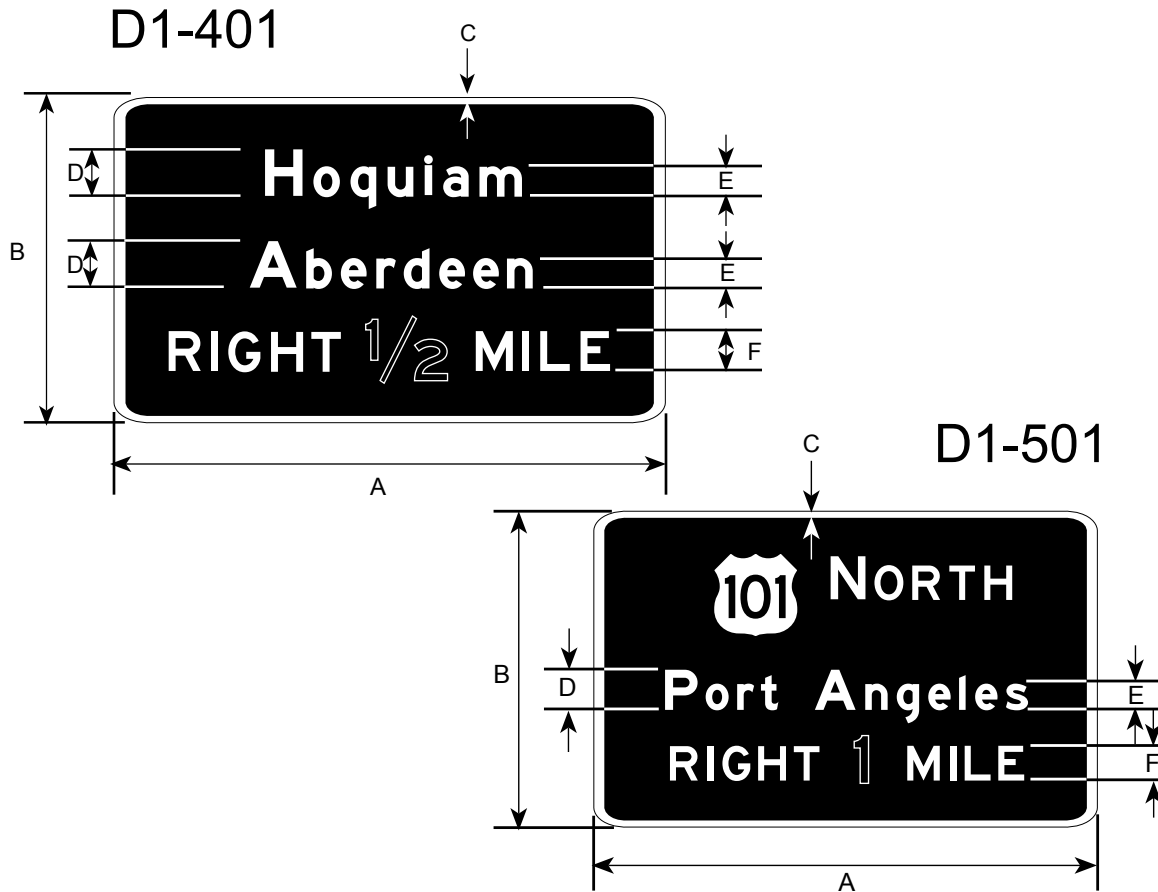

DIMENSIONS (MILLIMETERS)										
SIZE CODE	A	B	C	D	E	F	FRACTION SIZE	SHIELD SIZE	CARDINAL DIRECTION	NUMBER SIZE
A	VAR	VAR	38	200EM	150EM	150E	150E	450	200E/150E	200E
B	VAR	VAR	38	265EM	200EM	200E	200E	600	250E/200E	250E
C	VAR	VAR	50	333EM	250EM	250E	250E	900	300E/250E	300E
D	VAR	VAR	50	400EM	300EM	300E	300E	900	375E/300E	375E

DIMENSIONS (INCHES)										
SIZE CODE	A	B	C	D	E	F	FRACTION SIZE	SHIELD SIZE	CARDINAL DIRECTION	NUMBER SIZE
A	VAR	VAR	1 1/2	8EM	6EM	6E	6E	18	8E/6E	8E
B	VAR	VAR	1 1/2	10.6EM	8EM	8E	8E	24	10E/8E	10E
C	VAR	VAR	2	13.3EM	10EM	10E	10E	36	12E/10E	12E
D	VAR	VAR	2	16EM	12EM	12E	12E	36	15E/12E	15E

**COLORS**  
 LEGEND — WHITE (REFL)  
 BACKGROUND — GREEN (REFL)

# D1-601 & D1-602 & D1-603

1/06

## D1-601



## D1-602



## D1-603



\* SEE APPENDIX FOR STANDARD ARROW DETAILS

DIMENSIONS (MILLIMETERS)			
SIZE CODE	LETTER SIZE		BORDER WIDTH
	U.C.	L.C.	
A	200	150	38
B	265	200	38
C	333	250	50
D	400	300	50

DIMENSIONS (INCHES)			
SIZE CODE	LETTER SIZE		BORDER WIDTH
	U.C.	L.C.	
A	8	6	1 1/2
B	10.6	8	1 1/2
C	13.3	10	2
D	16	12	2

## COLORS

LEGEND — WHITE (REFL)  
 BACKGROUND — GREEN (REFL)  
 BACKGROUND — BROWN (REFL)  
 (Brown, National or State Parks Only)

# D1-701

5/06



\* SEE APPENDIX FOR STANDARD ARROW DETAILS

DIMENSIONS (MILLIMETERS)						
SIZE CODE	A	B	C	D	E	F
A	200EM	450	38	200E/150E	150EM	1 OR 2
B	265EM	600	38	250E/200E	200EM	3 OR 4
C	333EM	900	50	300E/250E	250EM	3 OR 4
D	400EM	900	50	375E/300E	300EM	5 OR 6

DIMENSIONS (INCHES)						
SIZE CODE	A	B	C	D	E	F
A	8EM	18	1 1/2	8E/6E	6EM	1 OR 2
B	10.6EM	24	1 1/2	10E/8E	8EM	3 OR 4
C	13.3EM	36	2	12E/10E	10EM	3 OR 4
D	16EM	36	2	15E/12E	12EM	5 OR 6

WHITE ON BROWN MAY BE SPECIFIED ON THE PLANS FOR RECREATIONAL SIGNING. HOWEVER, BROWN SHALL NOT BE USED WITH A NUMBERED HIGHWAY ROUTE DESIGNATION ON THE SIGN.

## COLORS

LEGEND — WHITE (REFL)  
BACKGROUND — GREEN (REFL)

# D1-801 & D1-901

12/05

## D1-801



## D1-901



\* SEE APPENDIX FOR STANDARD ARROW DETAILS

DIMENSIONS (MILLIMETERS)								
SIZE CODE	LETTER SIZE		CARDINAL DIRECTION	SHIELD SIZE	VERTICAL DIMENSION		BORDER WIDTH	ARROW SIZE
	U.C.	L.C.			D1-801	D1-901		
A	200	150	200E/150E	450	2400	1200	38	1
B	265	200	250E/200E	600	3000	1500	50	3

DIMENSIONS (INCHES)								
SIZE CODE	LETTER SIZE		CARDINAL DIRECTION	SHIELD SIZE	VERTICAL DIMENSION		BORDER WIDTH	ARROW SIZE
	U.C.	L.C.			D1-801	D1-901		
A	8	6	8E/6E	18	96	48	1 1/2	1
B	10.6	8	10E/8E	24	120	60	2	3

### COLORS

LEGEND — WHITE (REFL)  
BACKGROUND — GREEN (REFL)

# D3-101

10/97

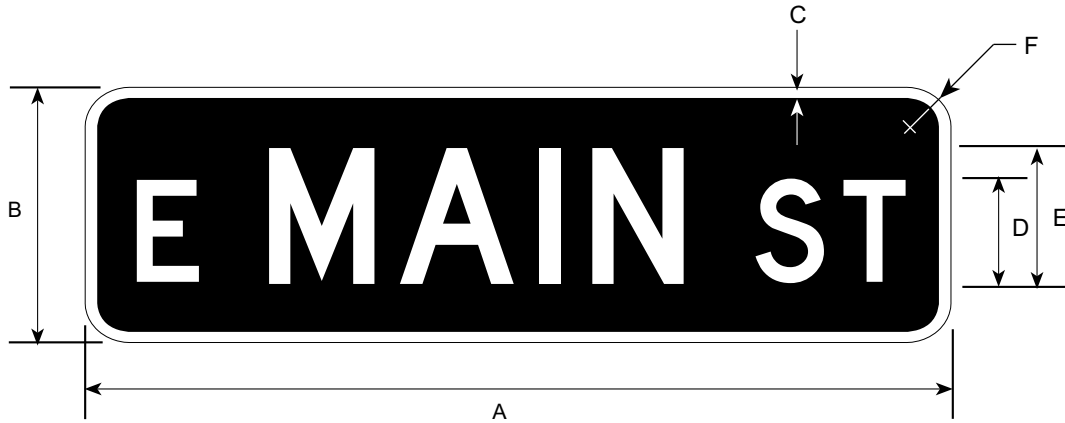

DIMENSIONS (MILLIMETERS)					
A	B	C	D	E	F
VA	200	16	75D	100D	38
VA	300	22	100D	150D	56
VA	400	31	150D	200D	75

DIMENSIONS (INCHES)					
A	B	C	D	E	F
VA	8	5/8	3D	4D	1 1/2
VA	12	7/8	4D	6D	2 1/4
VA	16	1 1/4	6D	8D	3

## COLORS

LEGEND — WHITE (REFL)  
 BACKGROUND — GREEN (REFL)

# D3-102

12/05



DIMENSIONS (MILLIMETERS)			
A	B	C	D
VAR	150	100D	50D
VAR	225	150C	100C
VAR	300	200C	150C

DIMENSIONS ( INCHES )			
A	B	C	D
VAR	6	4D	2D
VAR	9	6C	4C
VAR	12	8C	6C

## COLORS

LEGEND — WHITE (REFL)  
BACKGROUND — GREEN (REFL)

# D3-103

10/00

## DOUBLE FACED STREET NAME SIGN



NOTE: 4" MOUNTING AREA IS GREEN REFLECTIVE SHEETING

DIMENSIONS (MILLIMETERS)				
A	B	C	D	E
VAR	400	19	150D	38

DIMENSIONS (INCHES)				
A	B	C	D	E
VAR	16	3/4	6D	1 1/2

### COLORS

LEGEND — WHITE (REFL)  
BACKGROUND — GREEN (REFL)



# D3-104

12/05

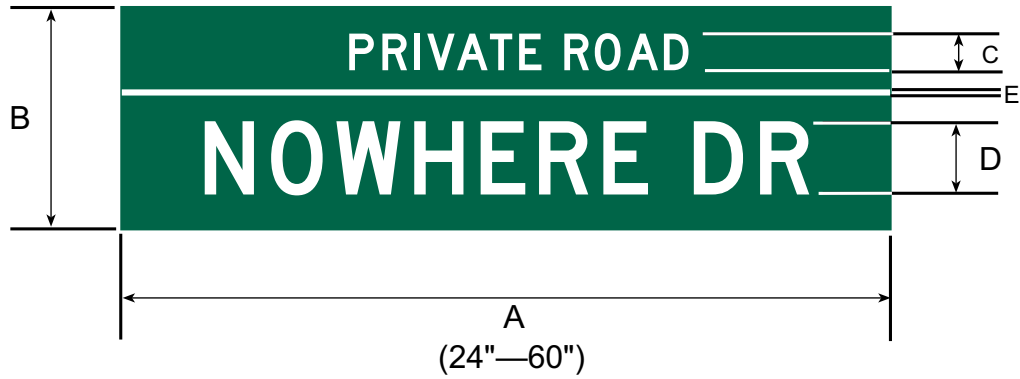

DIMENSIONS (MILLIMETERS)				
A	B	C	D	E
VAR	300	50D	150C	16

DIMENSIONS (INCHES)				
A	B	C	D	E
VAR	12	2D	6C*	5/8

\* 6C PREFERRED, 6B ALLOWED IF NECESSARY

## COLORS

LEGEND, SEPARATION BAR—WHITE (REFL)

BACKGROUND—GREEN (REFL)

# D3-2

1/06

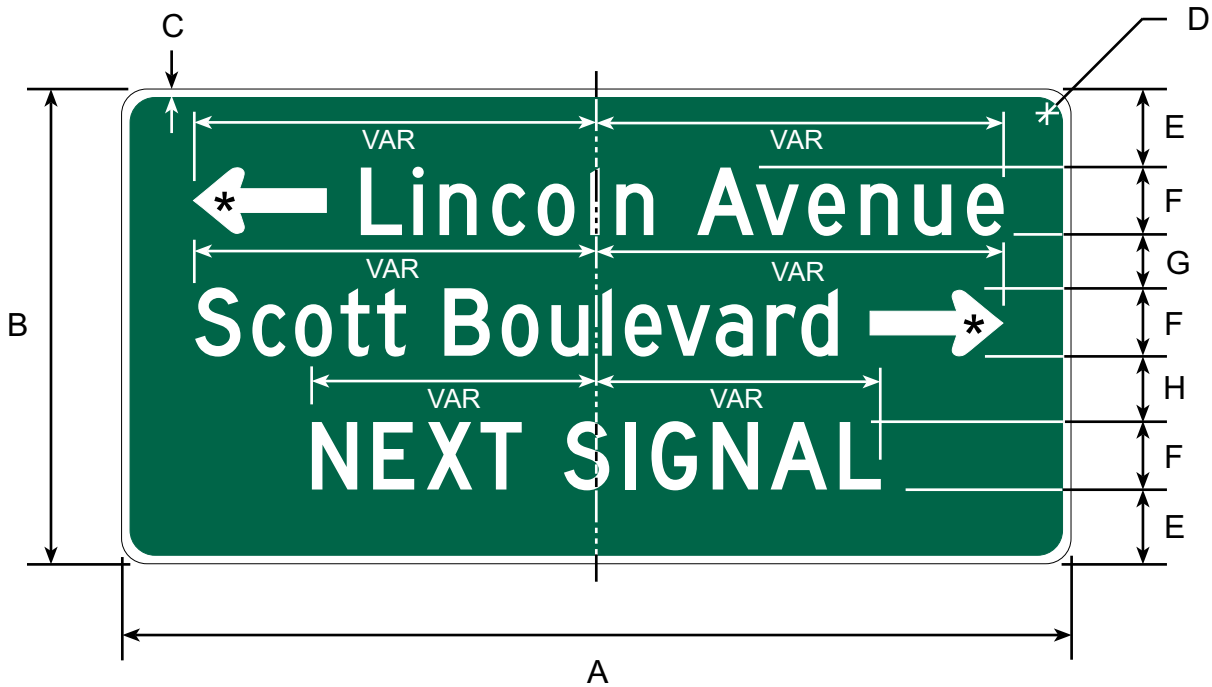

\* SEE APPENDIX FOR STANDARD ARROW DETAILS

DIMENSIONS (MILLIMETERS)							
A	B	C	D	E	F	G	H
VAR	1050	19	56	175	150D	100	150
VAR	1350	25	75	163	150D	100	113

DIMENSIONS (INCHES)							
A	B	C	D	E	F	G	H
VAR	42	3/4	2 1/4	7	6D	4	6
VAR	54	1	3	6 1/2	6D	4	4 1/2

## COLORS

LEGEND - WHITE (REFL)  
BACKGROUND - GREEN (REFL)

# D3-2A

1/06

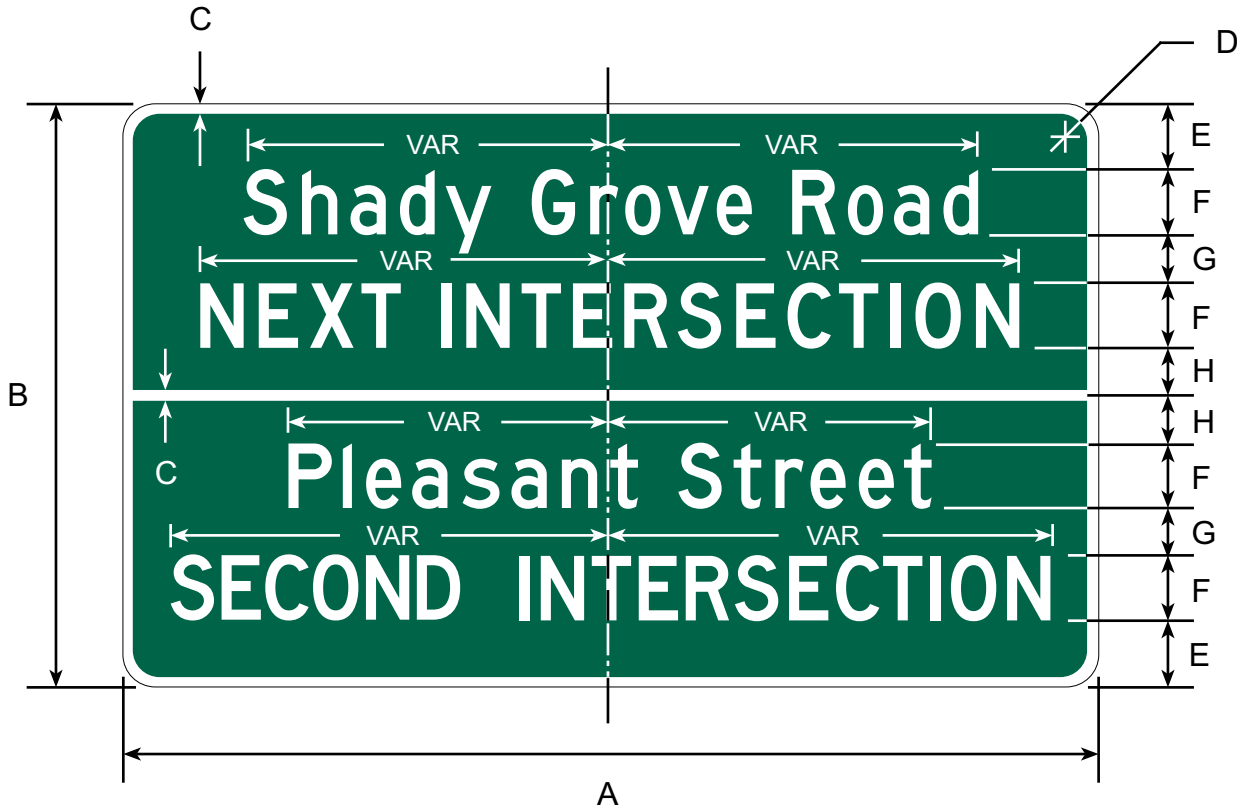

DIMENSIONS (MILLIMETERS)							
A	B	C	D	E	F	G	H
VAR	1350	25	75	150	150D	113	113

DIMENSIONS (INCHES)							
A	B	C	D	E	F	G	H
VAR	54	1	3	6	6D	4 1/2	4 1/2

## COLORS

LEGEND - WHITE (REFL)  
 BACKGROUND - GREEN (REFL)

# D3-201

12/05



NOTE: SERIES C LETTERS MAY BE USED WHEN SPECIFIED ON THE PLANS

DIMENSIONS (MILLIMETERS)		
A	B	C
VAR	150	100D
VAR	225	125D
VAR	300	150D
VAR	400	200D

DIMENSIONS (INCHES)		
A	B	C
VAR	6	4D
VAR	9	5D
VAR	12	6D
VAR	16	8D

## COLORS

LEGEND — BLACK (NON-REFL)  
BACKGROUND — YELLOW (REFL)

# D3-301

12/05

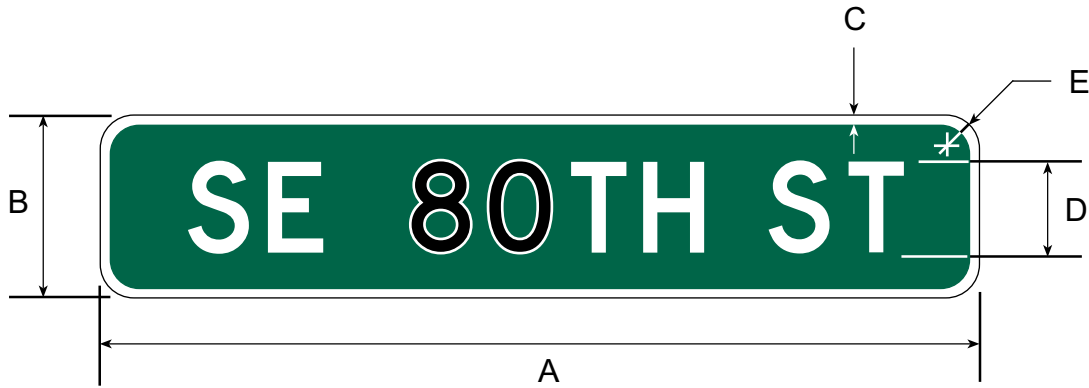

DIMENSIONS (MILLIMETERS)				
A	B	C	D	E
VAR	300	19	150D	38
VAR	400	19	200D	38

DIMENSIONS (INCHES)				
A	B	C	D	E
VAR	12	3/4	6D	1 1/2
VAR	16	3/4	8D	1 1/2

## COLORS

LEGEND — WHITE (REFL)  
 BACKGROUND — GREEN (REFL)

# D3-302

12/05



DIMENSIONS (MILLIMETERS)							
	A	B	C	D	E	F	G
1 LINE	VAR	300	19	150D	38	45°	150
1 LINE	VAR	400	19	200D	38	45°	200
2 LINES	VAR	600	19	150D	38	45°	200
2 LINES	VAR	750	19	200D	38	45°	200

DIMENSIONS (INCHES)							
	A	B	C	D	E	F	G
1 LINE	VAR	12	3/4	6D	1 1/2	45°	6
1 LINE	VAR	16	3/4	8D	1 1/2	45°	8
2 LINES	VAR	24	3/4	6D	1 1/2	45°	8
2 LINES	VAR	30	3/4	8D	1 1/2	45°	8

## COLORS

LEGEND — WHITE (REFL)  
BACKGROUND — GREEN (REFL)

# D3-401

12/05



DIMENSIONS (MILLIMETERS)								
A	B	C	D	SHIELD SIZE	NUM. SIZE & SERIES			E
					1 DIGIT	2 DIGITS	3 DIGITS	
VAR	300	22	150D	181 X 200	150C	125C	100C	56
VAR	450	31	200D	272 X 300	125C	75C	63C	75

DIMENSIONS (INCHES)								
A	B	C	D	SHIELD SIZE	NUM. SIZE & SERIES			E
					1 DIGIT	2 DIGITS	3 DIGITS	
VAR	12	7/8	6D	7 1/4 X 8	6C	5C	4C	2 1/4
VAR	18	1 1/4	8D	10 7/8 X 12	5C	3C	2 1/2C	3

## COLORS

- LEGEND - WHITE (REFL)
- SHIELD NUMBERS - BLACK (NON-REFL)
- BACKGROUND - GREEN (REFL)

# D4-1

10/97



\* SEE APPENDIX FOR STANDARD ARROW DETAILS

DIMENSIONS (MILLIMETERS)											
A	B	C	D	E	F	G	H	J	K	L	M
750	600	9	16	375E	113	75E	253	63	225	38	181

DIMENSIONS (INCHES)											
A	B	C	D	E	F	G	H	J	K	L	M
30	24	3/8	5/8	15E	4 1/2	3E	10 1/8	2 1/2	9	1 1/2	7 1/4

## COLORS

LEGEND - GREEN (NON REFL)  
BACKGROUND - WHITE (REFL)



# D4-2

10/97

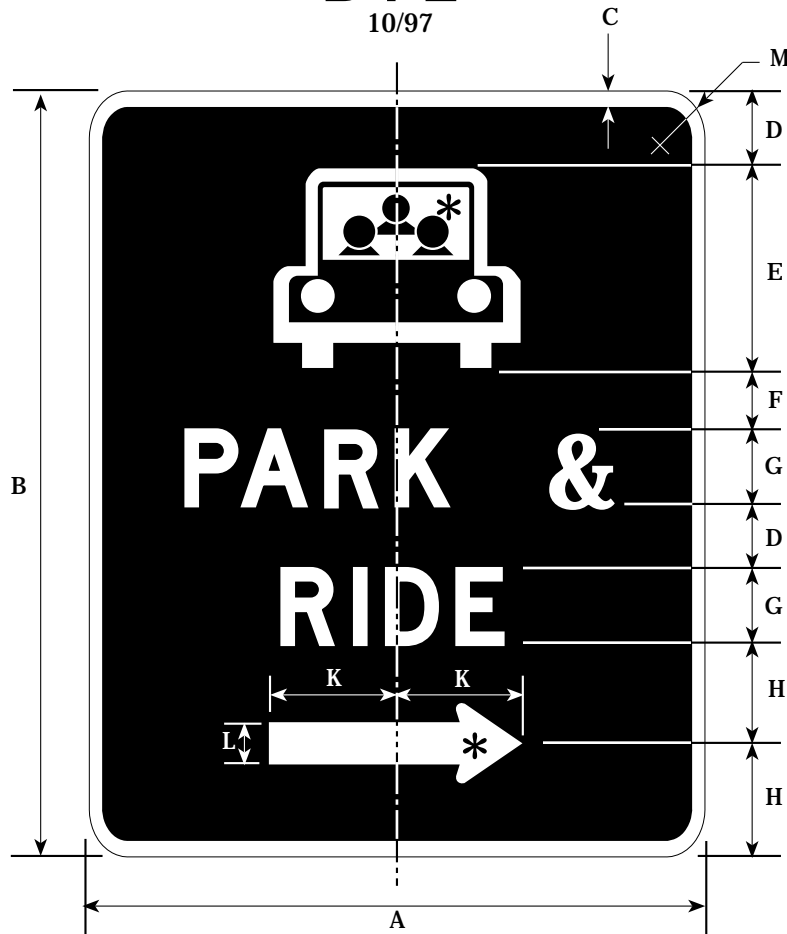

\* SEE APPENDIX FOR SYMBOL DESIGN AND STANDARD ARROW DETAILS  
CENTER CAR SYMBOL IF NO TRANSIT SYMBOL IS USED

DIMENSIONS (MILLIMETERS)										
A	B	C	D	E	F	G	H	K	L	M
600	750	16	50	200	75	75D	113	150	28	38
750	900	19	75	225	75	100D	125	175	38	47
900	1200	22	100	275	75	150D	175	225	56	56

DIMENSIONS (INCHES)										
A	B	C	D	E	F	G	H	K	L	M
24	30	5/8	2	8	3	3D	4 1/2	6	1 1/8	1 1/2
30	36	3/4	3	9	3	4D	5	7	1 1/2	1 7/8
36	48	7/8	4	11	3	6D	7	9	2 1/4	2 1/4

## COLORS

LEGEND, ARROW, & BORDER - WHITE (REFL.)

SYMBOL - WHITE & GREEN (REFL.)

BACKGROUND - GREEN (REFL.)

# D4-301

10/97

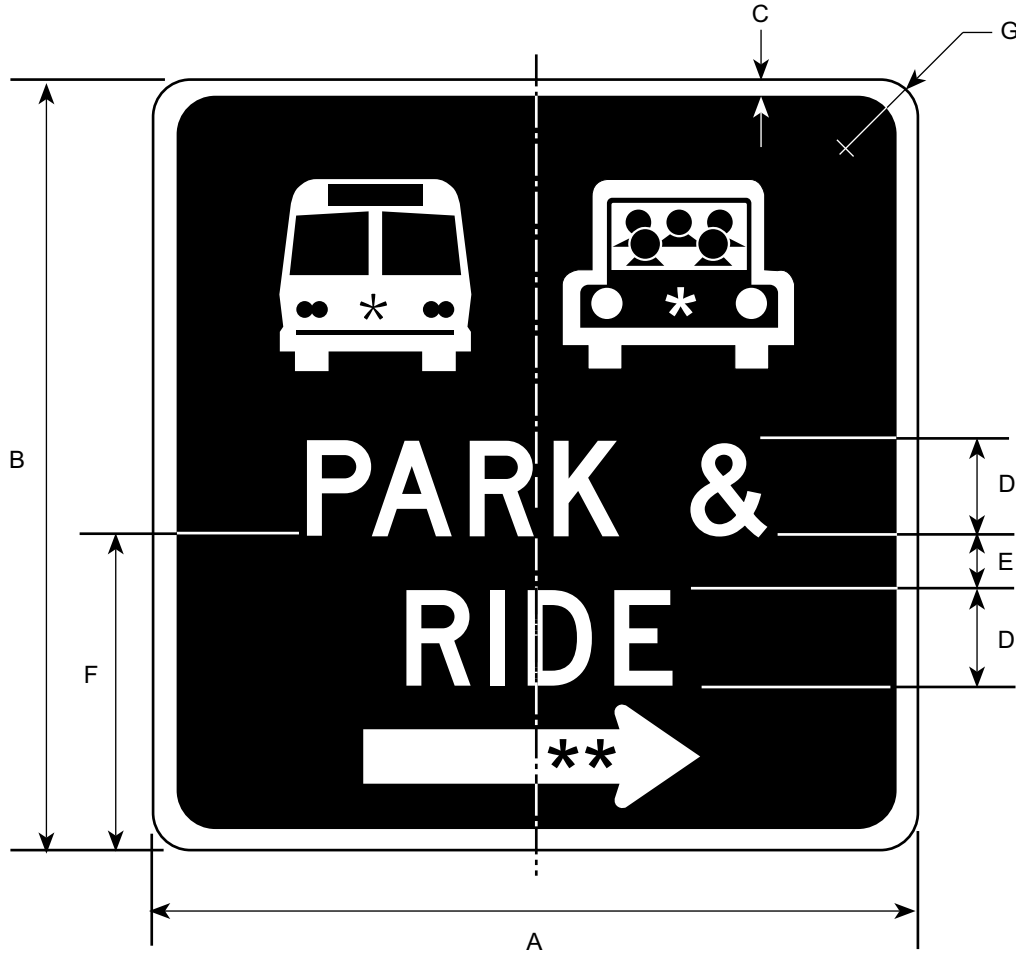

- \* SEE APPENDIX FOR SYMBOL DESIGN
- \*\* SEE APPENDIX FOR ARROW DETAILS

DIMENSIONS (MILLIMETERS)						
A	B	C	D	E	F	G
600	600	16	75D	50	300	38

DIMENSIONS (INCHES)						
A	B	C	D	E	F	G
24	24	5/8	3D	2	12	1 1/2

## COLORS

LEGEND — WHITE (REFL)  
 BACKGROUND — GREEN (REFL)

# D4-401

12/05



\* SEE APPENDIX FOR STANDARD ARROW DETAILS

DIMENSIONS (MILLIMETERS)					
A	B	C	ARROW	D	E
1500	1200	19	#2	150D	75
2400	1800	38	#4	200D	225

DIMENSIONS (INCHES)					
A	B	C	ARROW	D	E
60	48	3/4	#2	6D	3
96	72	1 1/2	#4	8D	9

## COLORS

LEGEND — WHITE (REFL)  
BACKGROUND — GREEN (REFL)

# D5-101

10/97

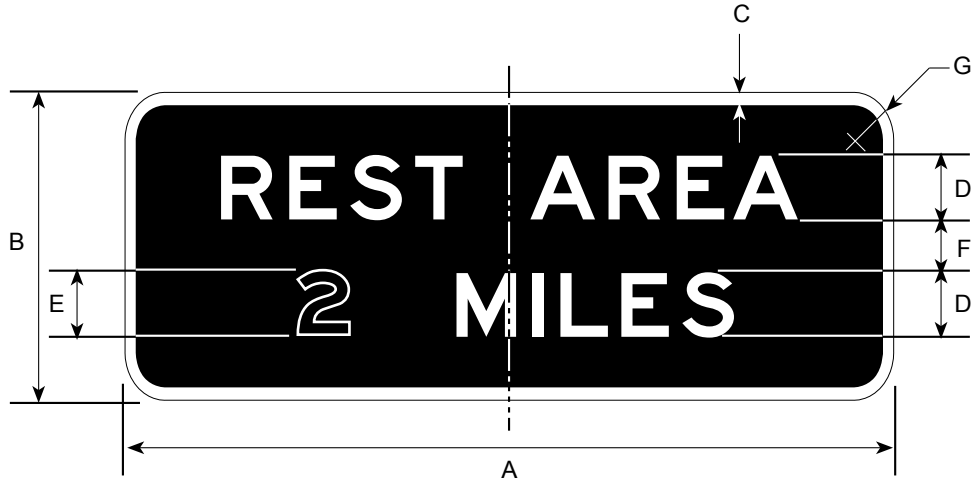

DIMENSIONS (MILLIMETERS)							
A	B	C	D	E	F	G	FRACTION SIZE
2400	900	38	200E	250	138	100	150
3000	1200	50	250E	300	200	150	200
3600	1500	50	300E	375	263	150	250

DIMENSIONS (INCHES)							
A	B	C	D	E	F	G	FRACTION SIZE
96	36	1 1/2	8E	10	5 1/2	4	6
120	48	2	10E	12	8	6	8
144	60	2	12E	15	10 1/2	6	10

## COLORS

LEGEND - WHITE (REFL)  
BACKGROUND - BLUE (REFL)

# D5-102

6/03



DIMENSIONS (MILLIMETERS)					
A	B	C	D	E	F
2400	600	19	150E	88	75
3000	900	38	200E	113	100

DIMENSIONS (INCHES)					
A	B	C	D	E	F
96	24	3/4	6E	3 1/2	3
120	36	1 1/2	8E	5 1/2	4

## COLORS

LEGEND - WHITE (REFL)  
 BACKGROUND - BLUE (REFL)

# D5-103

10/97

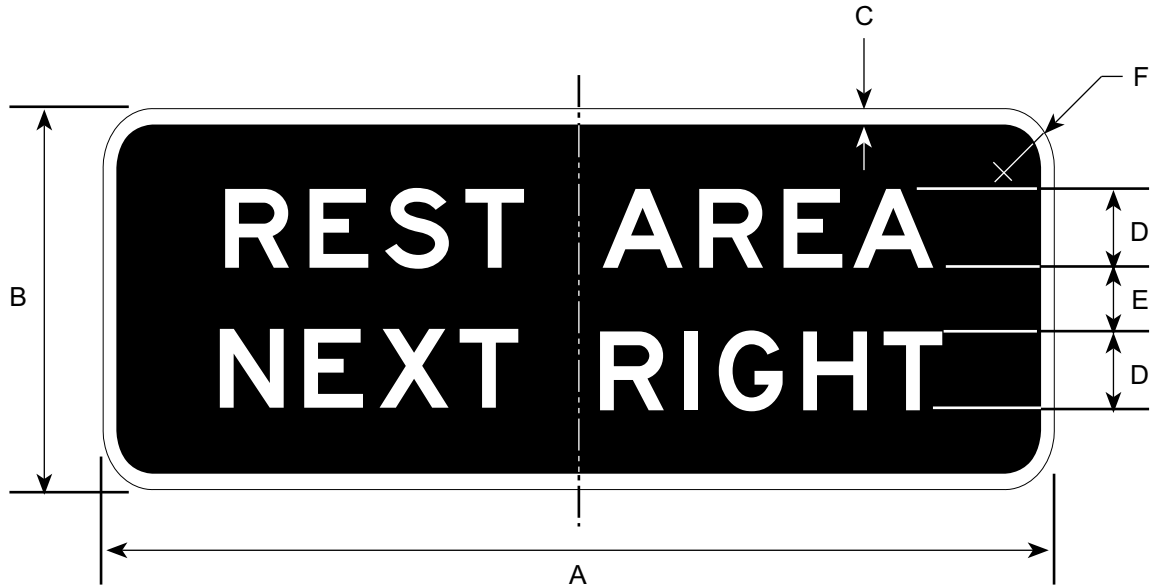

DIMENSIONS (MILLIMETERS)					
A	B	C	D	E	F
2400	900	38	200E	138	100
3000	1200	50	250E	200	150
3600	1500	50	300E	263	150

DIMENSIONS (INCHES)					
A	B	C	D	E	F
96	36	1 1/2	8E	5 1/2	4
120	48	2	10E	8	6
144	60	2	12E	10 1/2	6

## COLORS

LEGEND — WHITE (REFL)  
 BACKGROUND — BLUE (REFL)

# D5-201

12/05

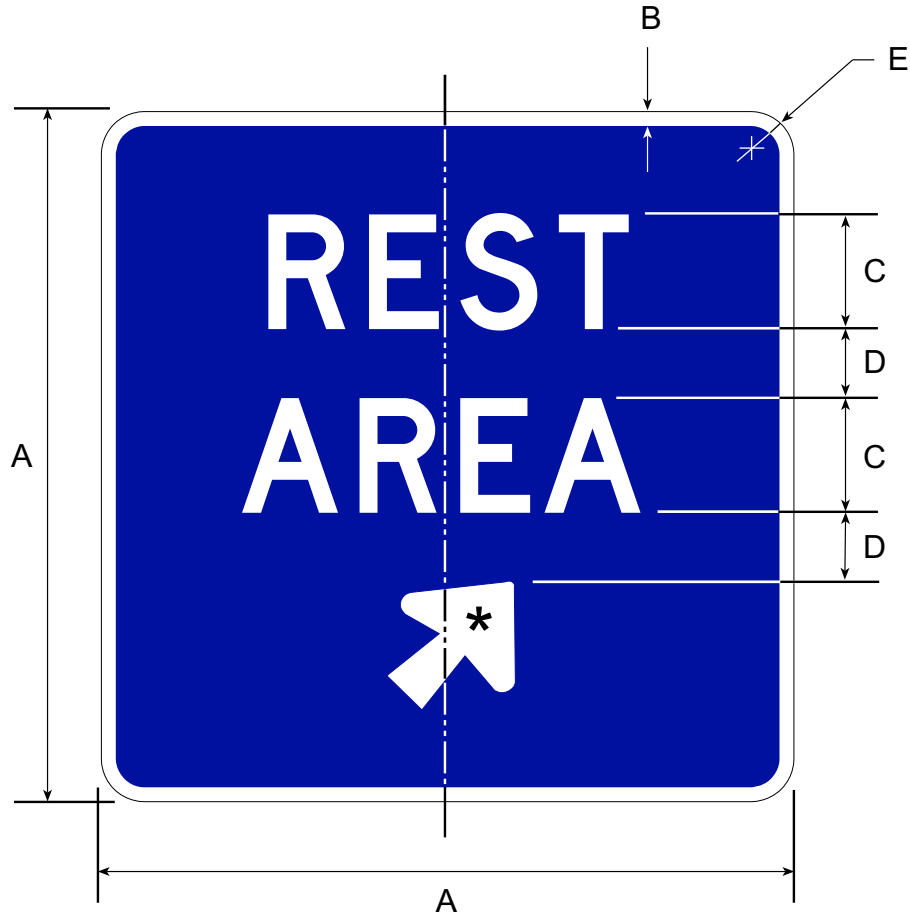

\* SEE APPENDIX FOR STANDARD ARROW DETAILS

DIMENSIONS (MILLIMETERS)					
A	B	C	D	E	ARROW SIZE
1200	38	200D	100	100	1
1500	50	250D	125	150	3
1800	50	300D	150	150	5

DIMENSIONS (INCHES)					
A	B	C	D	E	ARROW SIZE
48	1 1/2	8D	4	4	1
60	2	10D	5	6	3
72	2	12D	6	6	5

## COLORS

LEGEND — WHITE (REFL)  
BACKGROUND — BLUE (REFL)

# D5-202

10/97



DIMENSIONS (MILLIMETERS)								
A	B	C	D	E	F	G	H	J
3600	2550	50	300D	225	200	250	375E(M)	250

DIMENSIONS (INCHES)								
A	B	C	D	E	F	G	H	J
144	102	2	12D	9	8	10	15E(M)	10

## COLORS

LEGEND - WHITE (REFL)  
BACKGROUND - BLUE (REFL)



# D5-203

8/98



## EXIT DIRECTION REST AREA - VISITOR INFORMATION CENTER SIGN (ALTERNATE)

DIMENSIONS (MILLIMETERS)							
A	B	C	D	E	F	G	H
3600	2550	50	300D	225	200	250	250

DIMENSIONS (INCHES)							
A	B	C	D	E	F	G	H
144	102	2	12D	9	8	10	10

## COLORS

LEGEND - WHITE (REFL)  
BACKGROUND - BLUE (REFL)

# D5-204

12/05

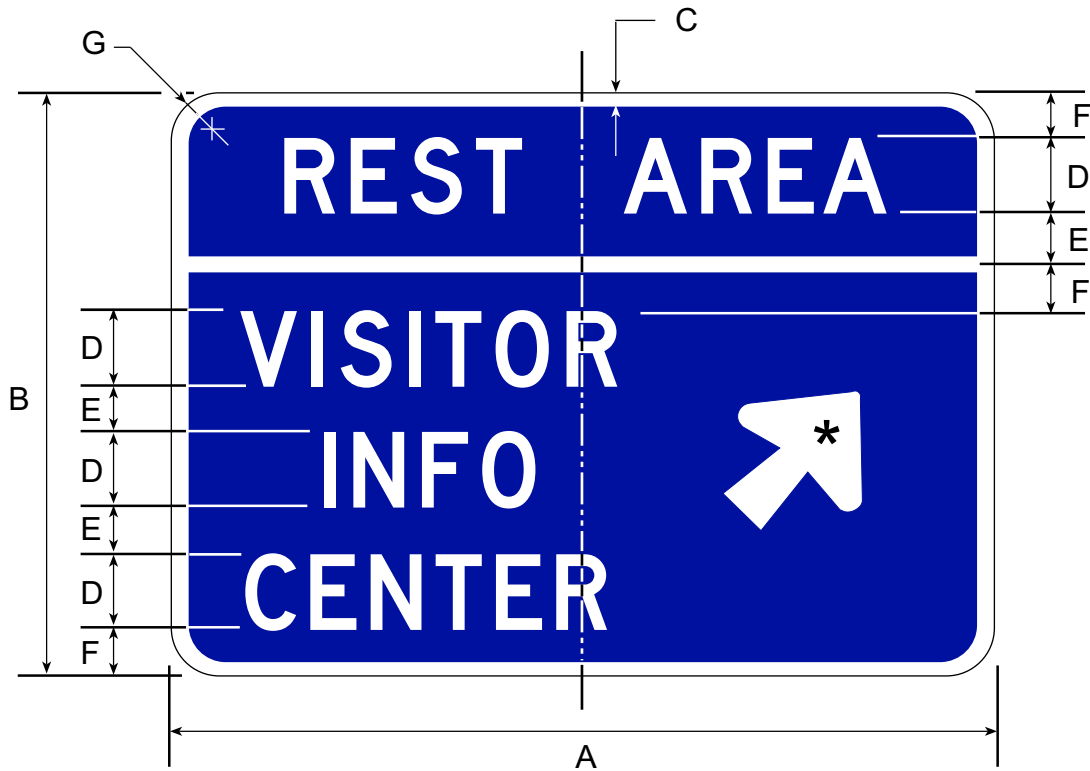

\* SEE APPENDIX FOR STANDARD ARROW DETAILS

DIMENSIONS (MILLIMETERS)							
A	B	C	D	E	F	G	ARROW SIZE
3000	2550	50	300D	200	250	250	4

DIMENSIONS (INCHES)							
A	B	C	D	E	F	G	ARROW SIZE
120	102	2	12D	8	10	10	4

## COLORS

SYMBOL, LEGEND — WHITE (REFL)  
 BACKGROUND — BLUE (REFL)

# D5-301

10/97

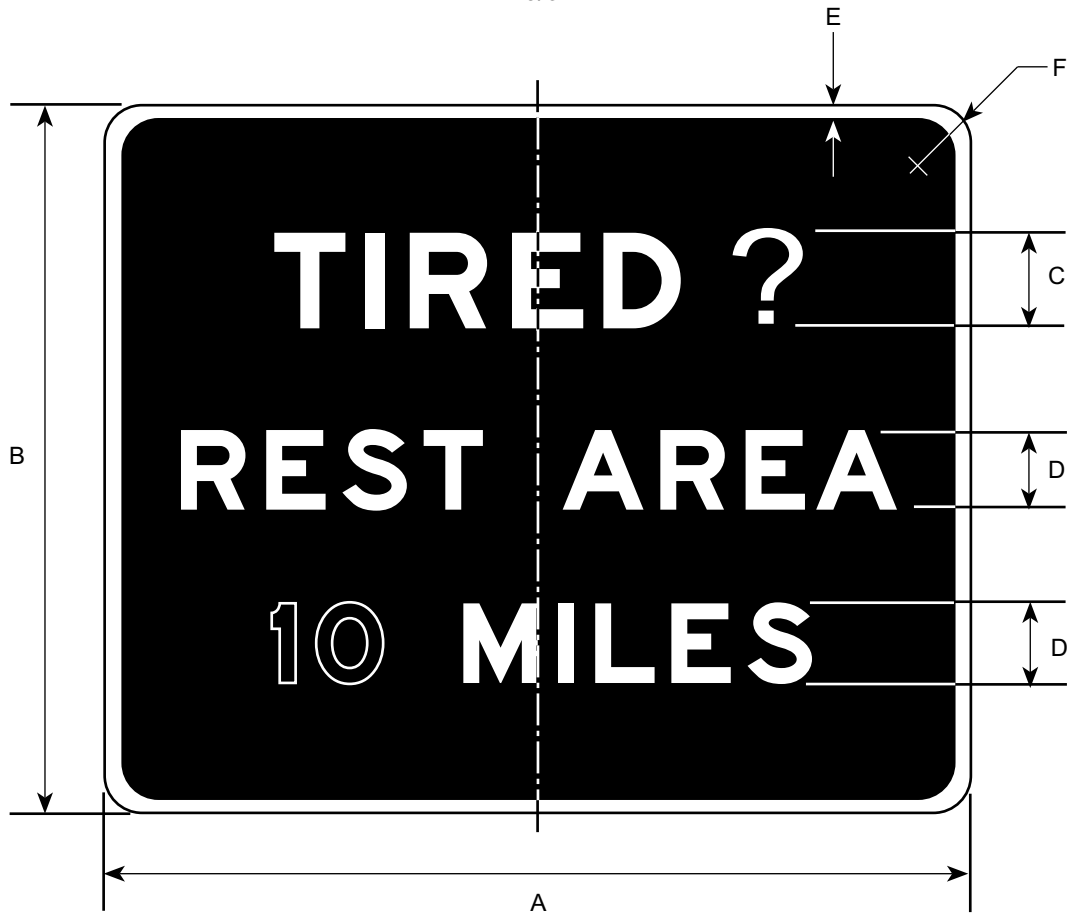

DIMENSIONS (MILLIMETERS)					
A	B	C	D	E	F
2700	1800	300E	250E	50	225

DIMENSIONS (INCHES)					
A	B	C	D	E	F
108	72	12E	10E	2	9

## COLORS

LEGEND— WHITE (REFL)  
 BACKGROUND— BLUE (REFL)

# D5-601

10/97

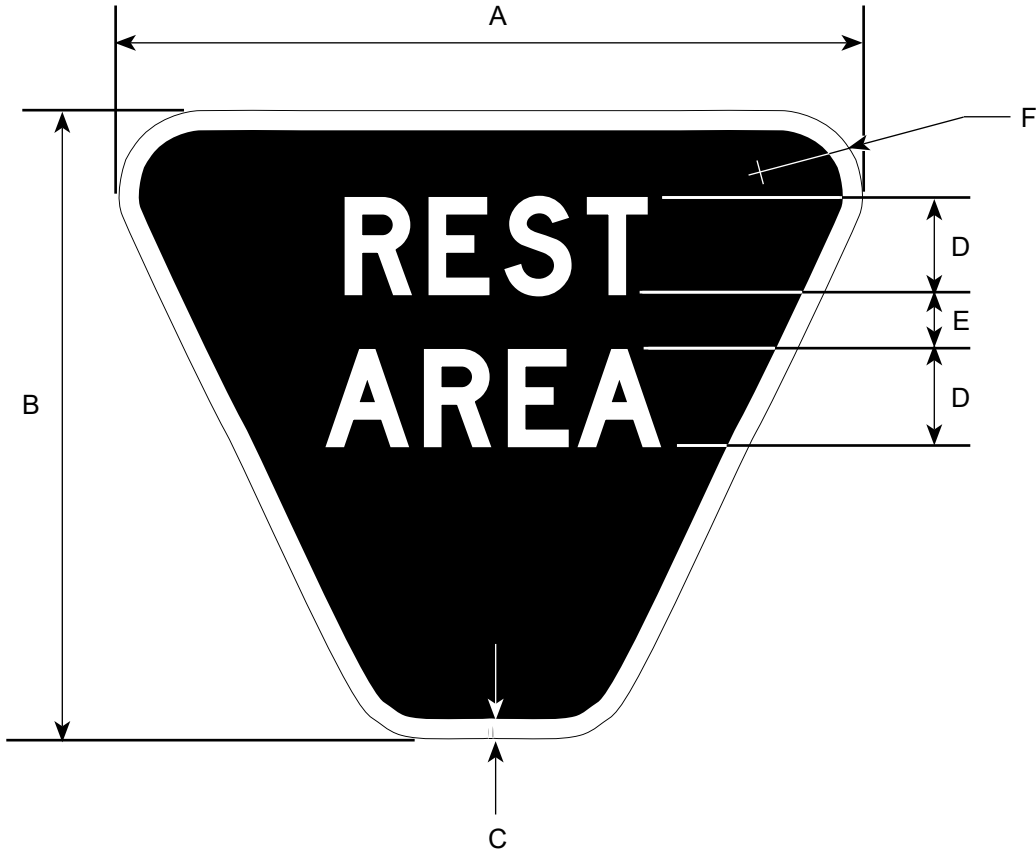

DIMENSIONS (MILLIMETERS)					
A	B	C	D	E	F
900	750	16	100D	75	75
1200	1000	25	150D	125	100

DIMENSIONS (INCHES)					
A	B	C	D	E	F
36	30	5/8	4D	3	3
48	40	1	6D	5	4

## COLORS

LEGEND - WHITE (REFL)  
 BACKGROUND - BLUE (REFL)

# D5-602

10/97

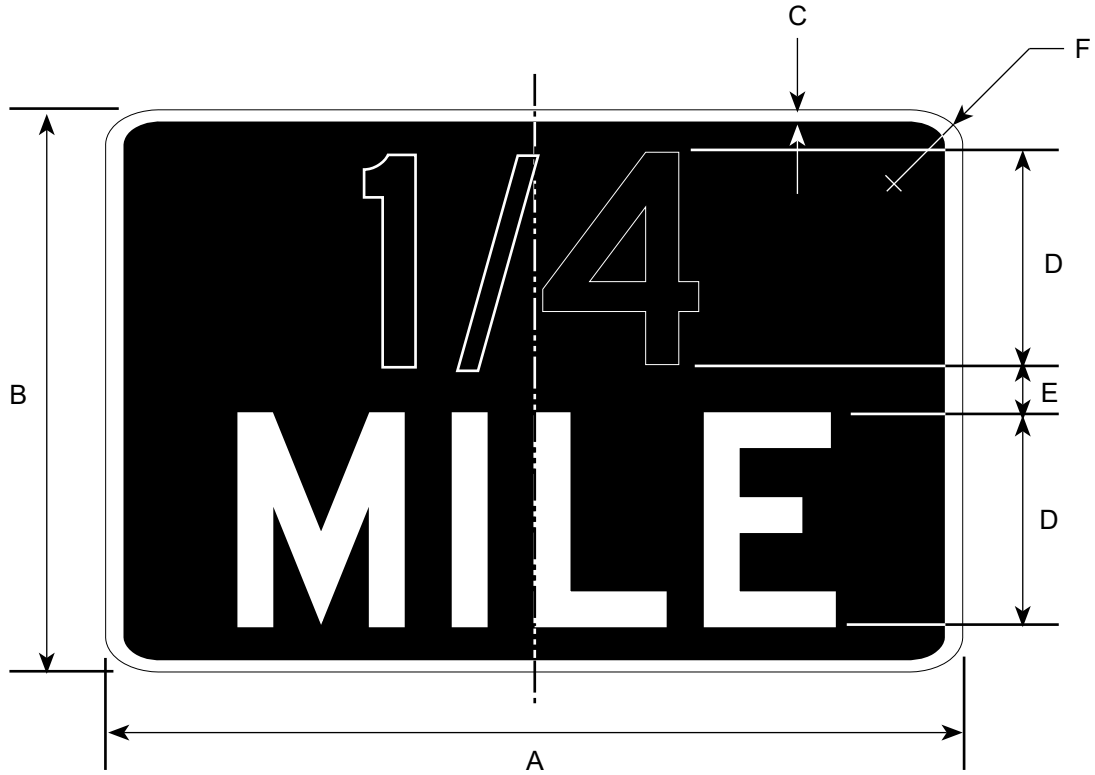

DIMENSIONS (MILLIMETERS)					
A	B	C	D	E	F
450	300	9	100D	25	38
600	450	13	150D	38	38

DIMENSIONS (INCHES)					
A	B	C	D	E	F
18	12	3/8	4D	1	1 1/2
24	18	1/2	6D	1 1/2	1 1/2

## COLORS

LEGEND - WHITE (REFL)  
BACKGROUND - BLUE (REFL)

# D5-701

10/97

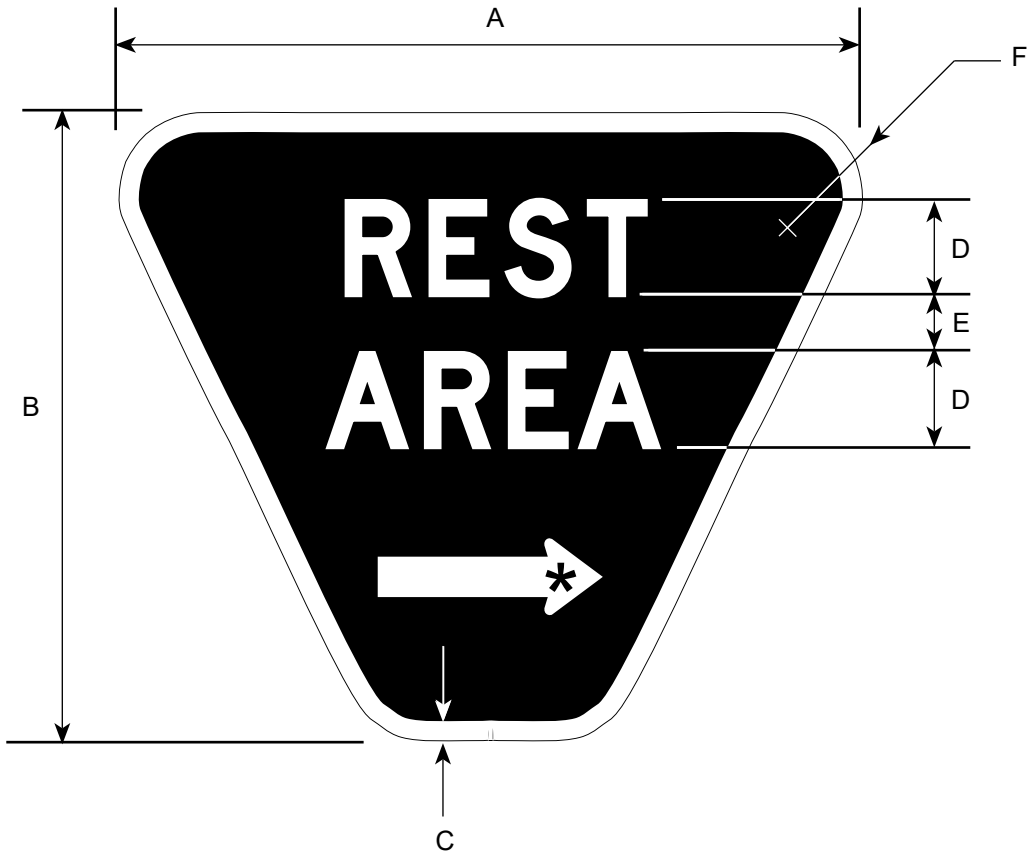

\* SEE APPENDIX FOR STANDARD ARROW DETAILS

DIMENSIONS (MILLIMETERS)						
A	B	C	D	E	F	ARROW SIZE
900	750	16	100D	75	75	200x100
1200	1000	25	150D	125	100	225x150

DIMENSIONS (INCHES)						
A	B	C	D	E	F	ARROW SIZE
36	30	5/8	4D	3	3	8x4
48	40	1	6D	5	4	9x6

## COLORS

LEGEND - WHITE (REFL)  
BACKGROUND - BLUE (REFL)

# D5-801

10/97



DIMENSIONS (MILLIMETERS)					
A	B	C	D	E	F
750	150	9	75D	150	19

DIMENSIONS (INCHES)					
A	B	C	D	E	F
30	6	3/8	3D	6	3/4

## COLORS

LEGEND - WHITE (REFL)  
BACKGROUND - BROWN (REFL)

# D5-901

10/97

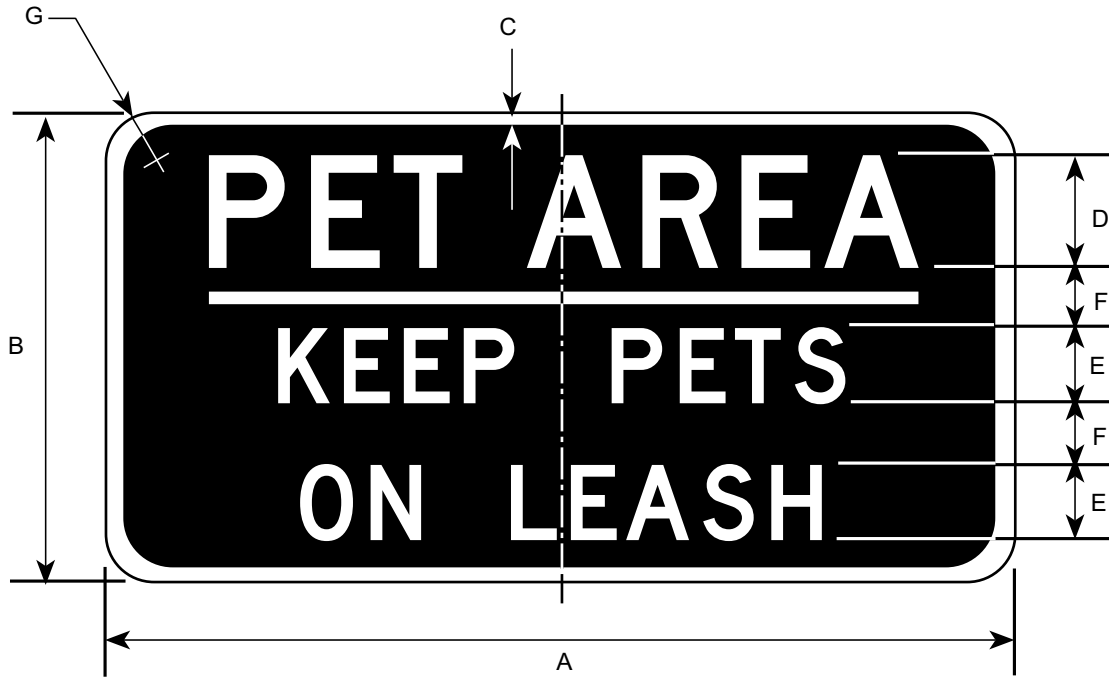

DIMENSIONS (MILLIMETERS)						
A	B	C	D	E	F	G
600	300	13	75D	50D	25	38

DIMENSIONS (INCHES)						
A	B	C	D	E	F	G
24	12	1/2	3D	2D	1	1 1/2

## COLORS

LEGEND — WHITE (REFL)  
 BACKGROUND — BROWN (REFL)



# RECREATIONAL FACILITY SYMBOL SIGNS

6/06

## D5 SERIES

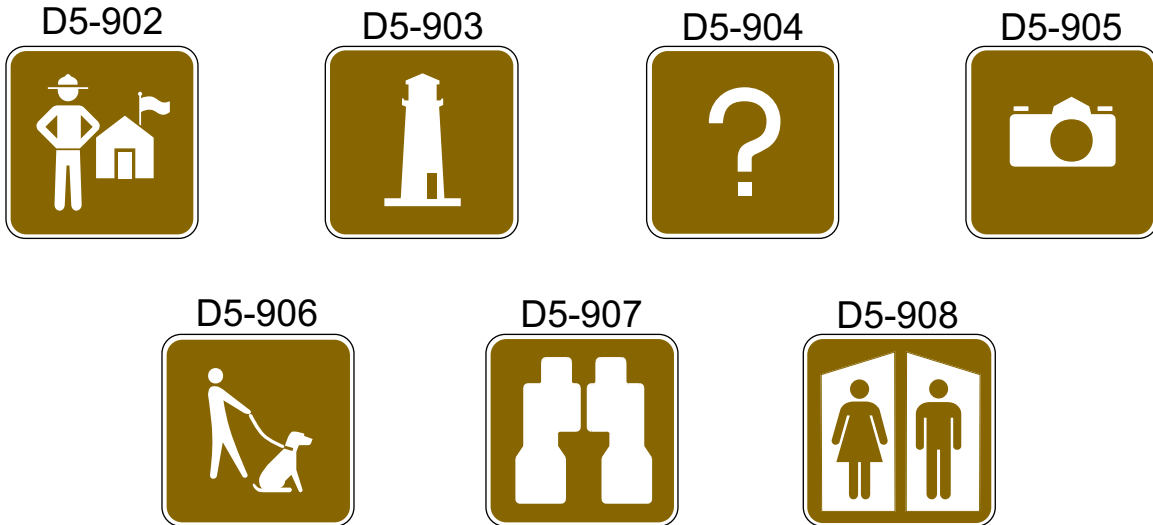

## D7 SERIES



Note: All signs are 600 millimeters x 600 millimeters (24 inches x 24 inches), with a 13 millimeter (1/2 inch) border and a 38 millimeter (1 1/2 inch) corner radius

### COLORS

SYMBOL — WHITE (REFL)  
BACKGROUND — BROWN (REFL)

# D6-1

12/05

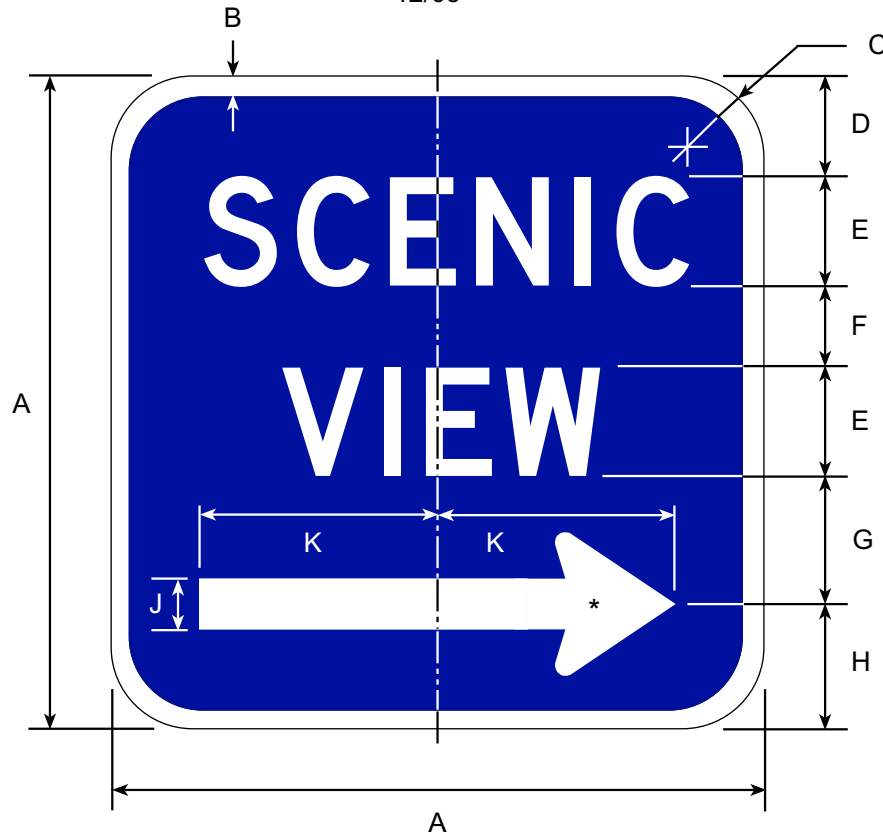

\* SEE APPENDIX FOR ARROW DETAILS

DIMENSIONS (MILLIMETERS)									
A	B	C	D	E	F	G	H	J	K
900	25	100	125	150D	110	175	190	69	338
1200	38	150	175	200D	150	225	250	88	450
1500	50	150	200	250D	195	300	305	113	563
1800	50	200	250	300D	225	360	365	138	675

DIMENSIONS (INCHES)									
A	B	C	D	E	F	G	H	J	K
36	1	4	5	6D	4 1/2	7	7 1/2	2 3/4	13 1/2
48	1 1/2	6	7	8D	6	9	10	3 1/2	18
60	2	6	8	10D	7 3/4	12	12 1/4	4 1/2	22 1/2
72	2	8	10	12D	9	14	15	5 1/2	27

## COLORS

LEGEND & ARROW - WHITE (REFL)  
 BACKGROUND - BLUE (REFL)

# D6-2

12/05

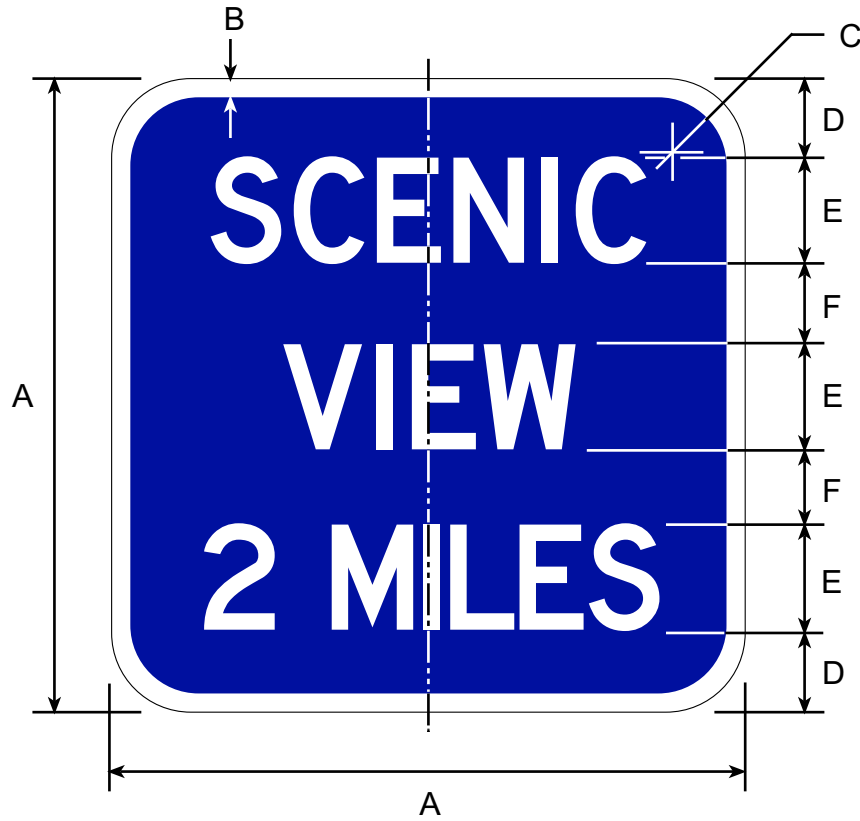

DIMENSIONS (MILLIMETERS)					
A	B	C	D	E	F
900	25	100	125	150D	100
1200	38	150	150	200D	150
1500	50	150	185	250D	190
1800	50	200	250	300D	200

DIMENSIONS (INCHES)					
A	B	C	D	E	F
36	1	4	5	6D	4
48	1 1/2	6	6	8D	6
60	2	6	7 1/2	10D	7 1/2
72	2	8	10	12D	8

## COLORS

LEGEND - WHITE (REFL)  
 BACKGROUND - BLUE (REFL)

# D6-3

12/05

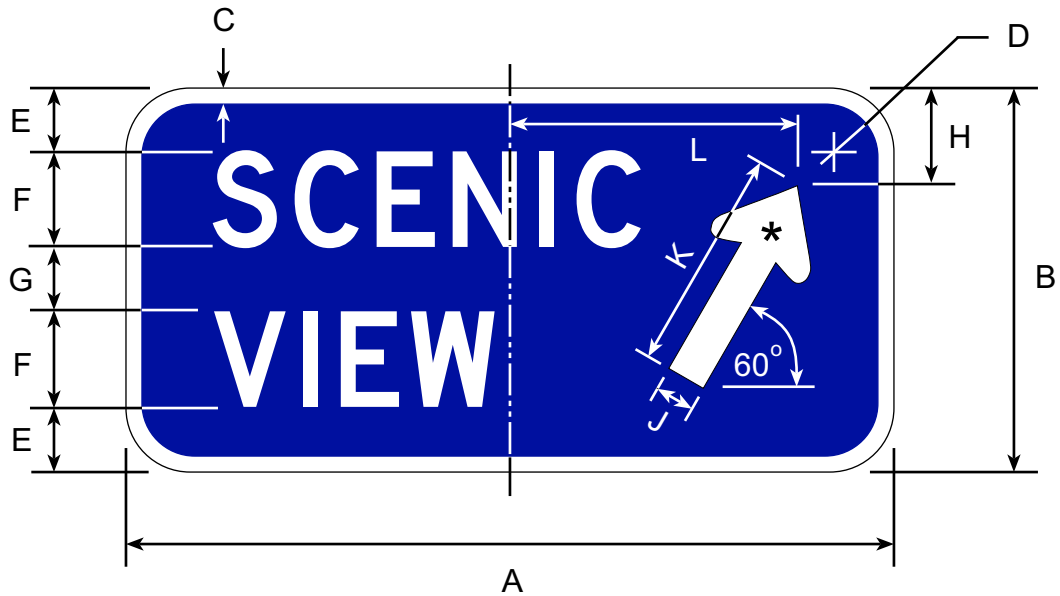

\* SEE APPENDIX FOR ARROW DETAILS

DIMENSIONS (MILLIMETERS)										
A	B	C	D	E	F	G	H	J	K	L
1200	600	25	100	100	150D	100	150	69	350	500
1500	900	38	150	175	200D	150	200	88	500	600
1800	1200	50	150	250	250D	200	250	113	675	700
2400	1350	50	200	250	300D	250	300	138	775	950

DIMENSIONS (INCHES)										
A	B	C	D	E	F	G	H	J	K	L
48	24	1	4	4	6D	4	6	2 3/4	14	18
60	36	1 1/2	6	7	8D	6	8	3 1/2	20	24
72	48	2	6	10	10D	8	10	4 1/2	27	28
96	54	2	8	10	12D	10	12	5 1/2	31	38

## COLORS

LEGEND & ARROW - WHITE (REFL)  
 BACKGROUND - BLUE (REFL)

# D7-101

10/97



NOTE: ANGLE OF SLOPE IS  $52\ 1/2^{\circ}$  FROM HORIZONTAL

DIMENSIONS (MILLIMETERS)					
A	B	C	D	E	F
VAR	VAR	19	150D	VAR	75
VAR	VAR	38	200D	VAR	150

DIMENSIONS (INCHES)					
A	B	C	D	E	F
VAR	VAR	3/4	6D	VAR	3
VAR	VAR	1 1/2	8D	VAR	6

**COLORS**  
**LEGEND - WHITE (REFL)**  
**BACKGROUND - BROWN (REFL)**

# D7-201

10/97

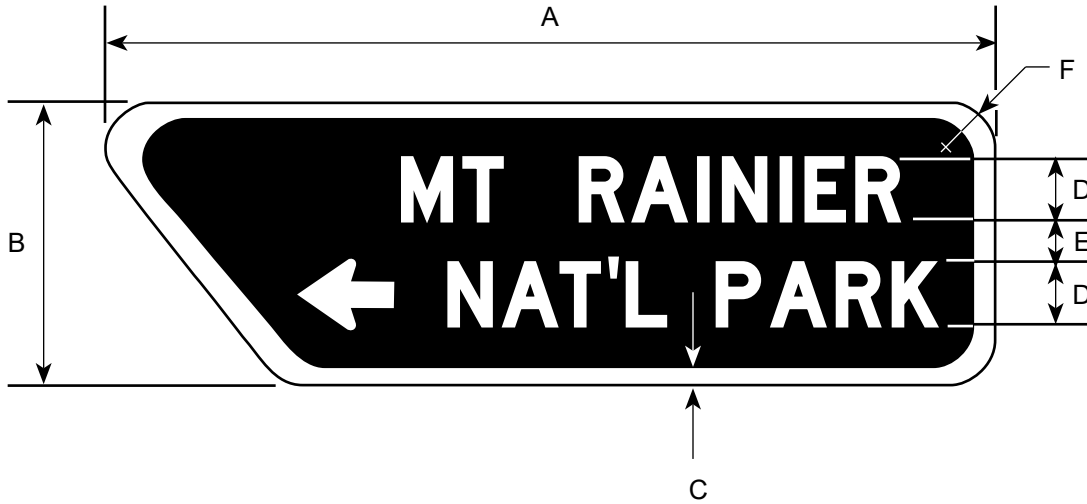

\* See appendix for standard arrow details

NOTE: ANGLE OF SLOPE IS  $52\ 1/2^{\circ}$  FROM HORIZONTAL  
DIMENSIONS TYPICAL OF BOTH SIGNS

DIMENSIONS (MILLIMETERS)					
A	B	C	D	E	F
VAR	VAR	19	150D	VAR	75
VAR	VAR	38	200D	VAR	150

DIMENSIONS (INCHES)					
A	B	C	D	E	F
VAR	VAR	3/4	6D	VAR	3
VAR	VAR	1 1/2	8D	VAR	6

## COLORS

LEGEND - WHITE (REFL)  
BACKGROUND - BROWN (REFL)

# D7-301, D7-301L & D7-301R

10/97

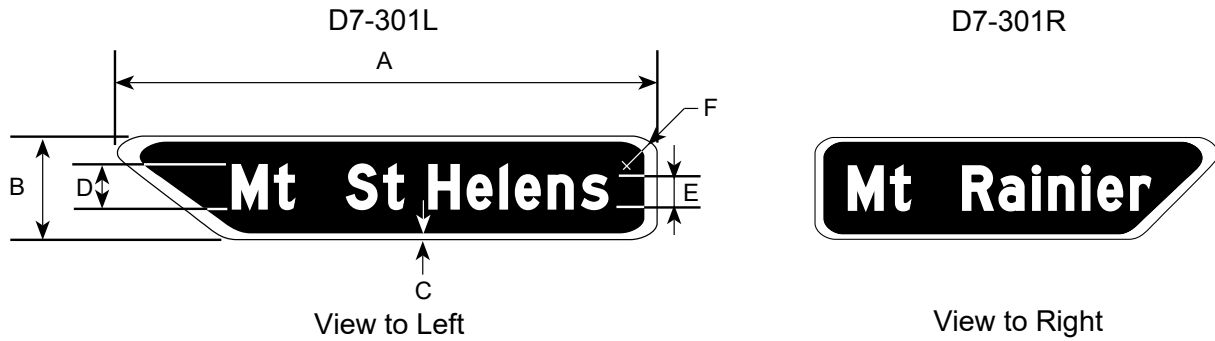

D7-301



View Straight Ahead

NOTE: ANGLE OF SLOPE IS  $52\frac{1}{2}^{\circ}$  FROM HORIZONTAL  
DIMENSIONS TYPICAL OF ALL VIEW SIGNS

DIMENSIONS (MILLIMETERS)					
A	B	C	D	E	F
VAR	300	19	150	113	38

DIMENSIONS (INCHES)					
A	B	C	D	E	F
VAR	12	3/4	6	4 1/2	1 1/2

## COLORS

LEGEND - WHITE (REFL)  
BACKGROUND - BROWN (REFL)

# D7-301P

10/97

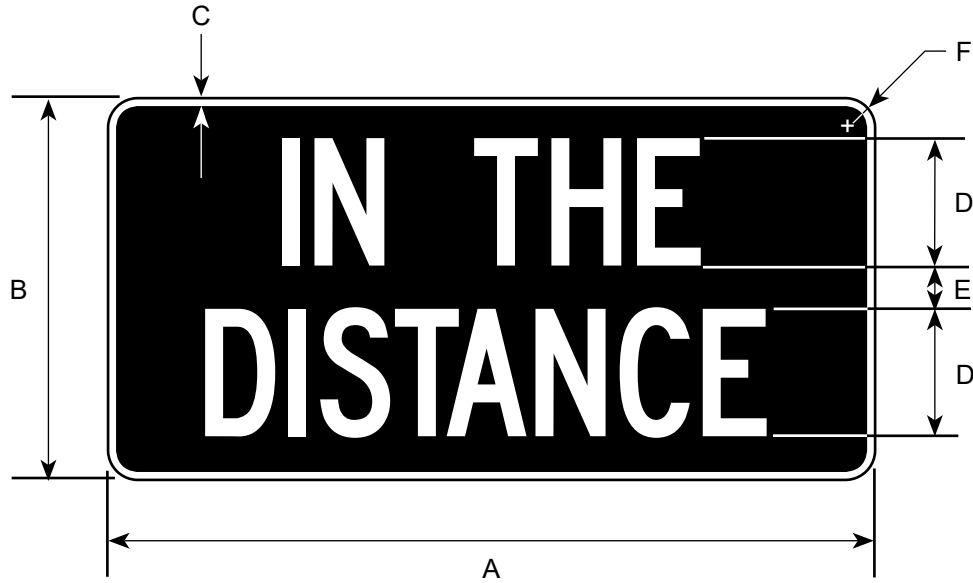

DIMENSIONS (MILLIMETERS)					
A	B	C	D	E	F
600	300	19	100C	31	38

DIMENSIONS (INCHES)					
A	B	C	D	E	F
24	12	3/4	4C	1 1/4	1 1/2

## COLORS

LEGEND - WHITE (REFL)  
BACKGROUND - BROWN (REFL)



# RECREATIONAL FACILITY SYMBOL SIGNS

6/06

## D7 SERIES (CONT'D)



## RECREATIONAL FACILITY LEGEND SIGNS



Note: All signs are 600 millimeters x 600 millimeters (24 inches x 24 inches), with a 13 millimeter (1/2 inch) border and a 38 millimeter (1 1/2 inch) corner radius

### COLORS

SYMBOL & LEGEND — WHITE (REFL)  
BACKGROUND — BROWN

# D7-7701

10/97

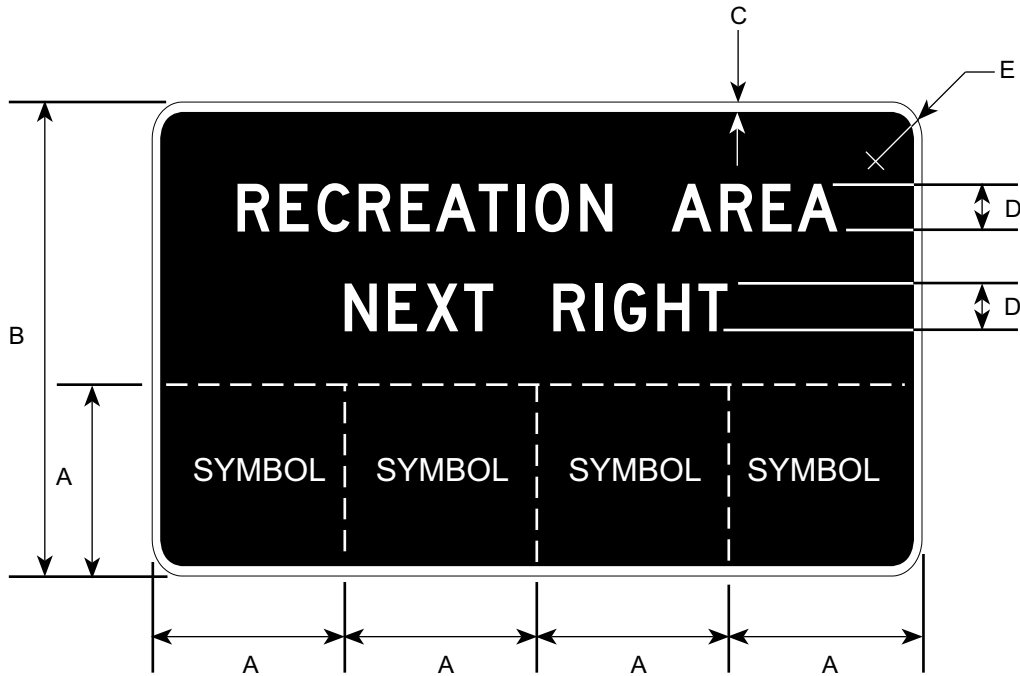

DIMENSIONS (MILLIMETERS)				
A	B	C	D	E
600	1500	16	150D	188

DIMENSIONS (INCHES)				
A	B	C	D	E
24	60	5/8	6D	7 1/2

## COLORS

LEGEND - WHITE (REFL)  
 BACKGROUND - BROWN (REFL)

# D8-1

10/97



DIMENSIONS (MILLIMETERS)							
A	B	C	D	E	F	G	H
1500	1200	38	150	200E	150E	150	75
1950	1500	50	200	250E	200E	175	100
2400	1800	50	225	300E	250E	225	125

DIMENSIONS (INCHES)							
A	B	C	D	E	F	G	H
60	48	1 1/2	6	8E	6E	6	3
78	60	2	8	10E	8E	7	4
96	72	2	9	12E	10E	9	5

## COLORS

LEGEND - WHITE (REFL)  
 BACKGROUND - GREEN (REFL)

# D8-101

10/97

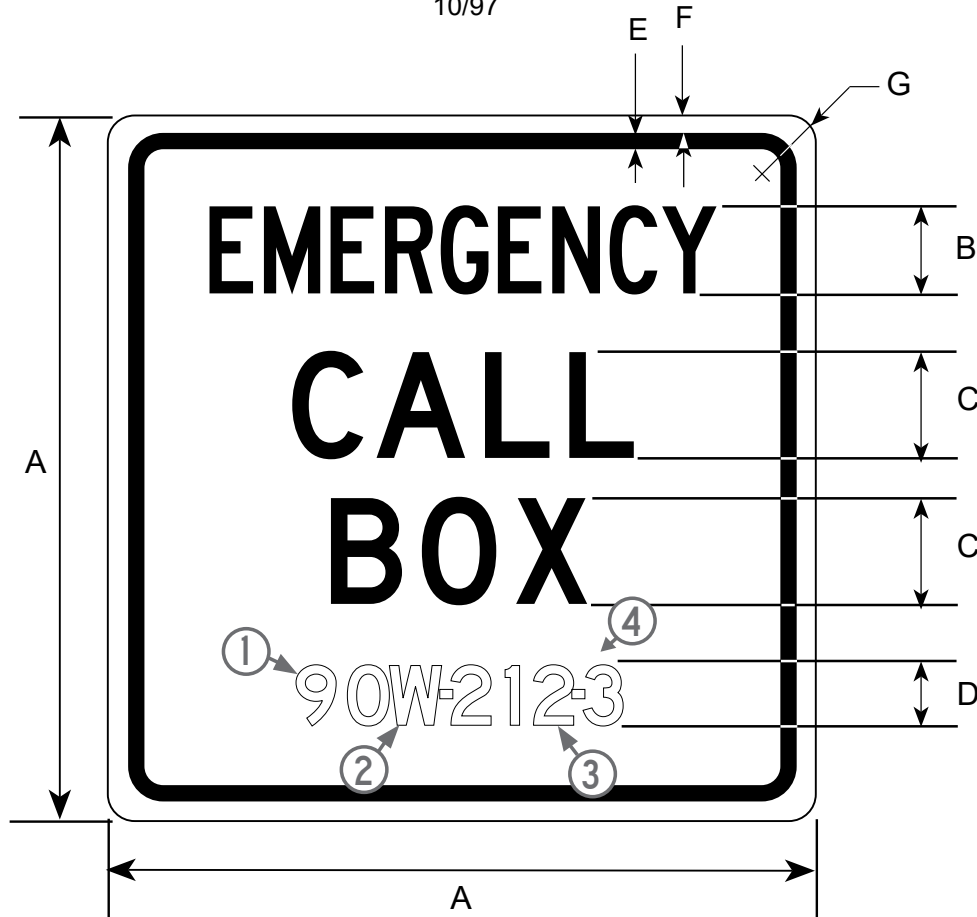

DIMENSIONS (MILLIMETERS)						
A	B	C	D	E	F	G
750	100	150	75	16	22	47

DIMENSIONS (INCHES)						
A	B	C	D	E	F	G
30	4C	6E	3C	5/8	7/8	1 7/8

- ① ROUTE NUMBER
- ② LANE DIRECTION. OTHER DESIGNATION MAY BE NEEDED.  
EXAMPLES: X; EXPRESS LANES, M; MEDIAN, R; RAMP.
- ③ MILE POST
- ④ THE NUMBER OF THE CALL BOX WITHIN THE MILEPOST,  
FOR LOCATIONS WHERE THERE IS MORE THAN ONE CALL BOX PER MILE.

## COLORS

LEGEND, BORDER - BLUE(REFL)

BACKGROUND - WHITE (REFL)

# D8-201

10/97

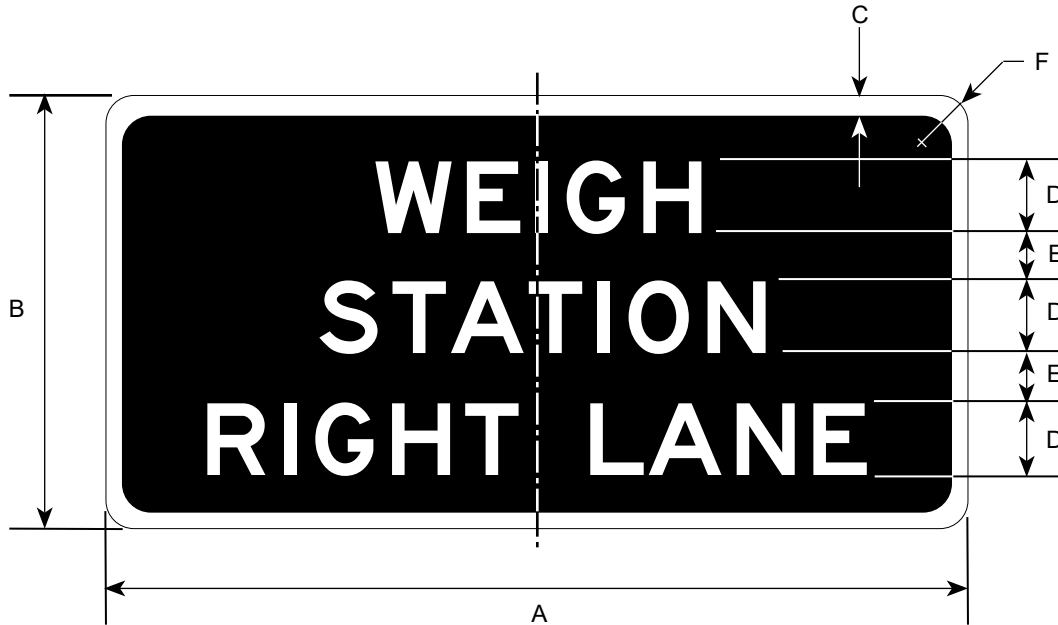

DIMENSIONS (MILLIMETERS)					
A	B	C	D	E	F
1800	900	38	150D	100	100
2700	1500	50	250D	175	150

DIMENSIONS (INCHES)					
A	B	C	D	E	F
72	36	1 1/2	6D	4	4
108	60	2	10D	7	6

## COLORS

LEGEND - WHITE (REFL)  
BACKGROUND - GREEN (REFL)

# D8-202

10/97

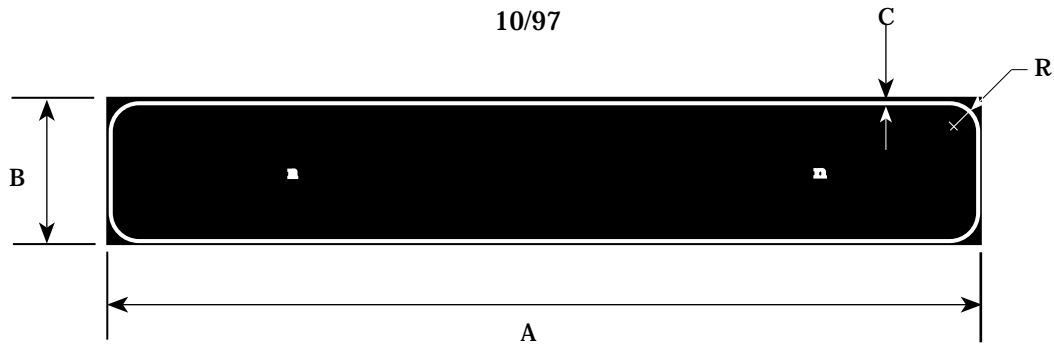

DIMENSIONS (MILLIMETERS)			
A	B	C	R
1800	300	38	100
2700	600	50	150

DIMENSIONS (INCHES)			
A	B	C	R
72	12	1 1/2	4
108	24	2	6

## FRONT

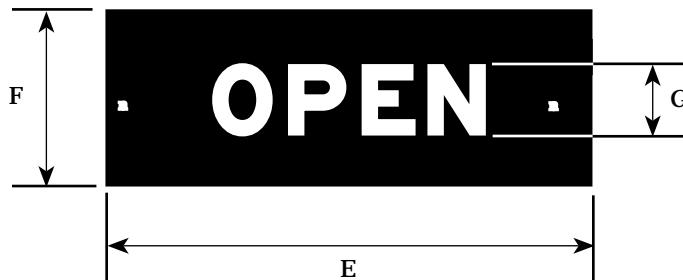

DIMENSIONS (MILLIMETERS)		
E	F	G
1050	200	150E
1650	300	250E

## BACK



DIMENSIONS (INCHES)		
E	F	G
42	8	6E
66	12	10E

THE OPEN-CLOSED PLAQUE MAY BE ATTACHED BY MEANS OF TWO STAINLESS STEEL 1/4" BOLTS 1/2" LONG AND WING NUTS. THE BOLT SHALL BE SECURED TO THE MAIN SIGN PANEL BY LOCKNUTS.

## COLORS

LEGEND - WHITE (REFL)  
BACKGROUND - GREEN (REFL)

# D8-301

12/05

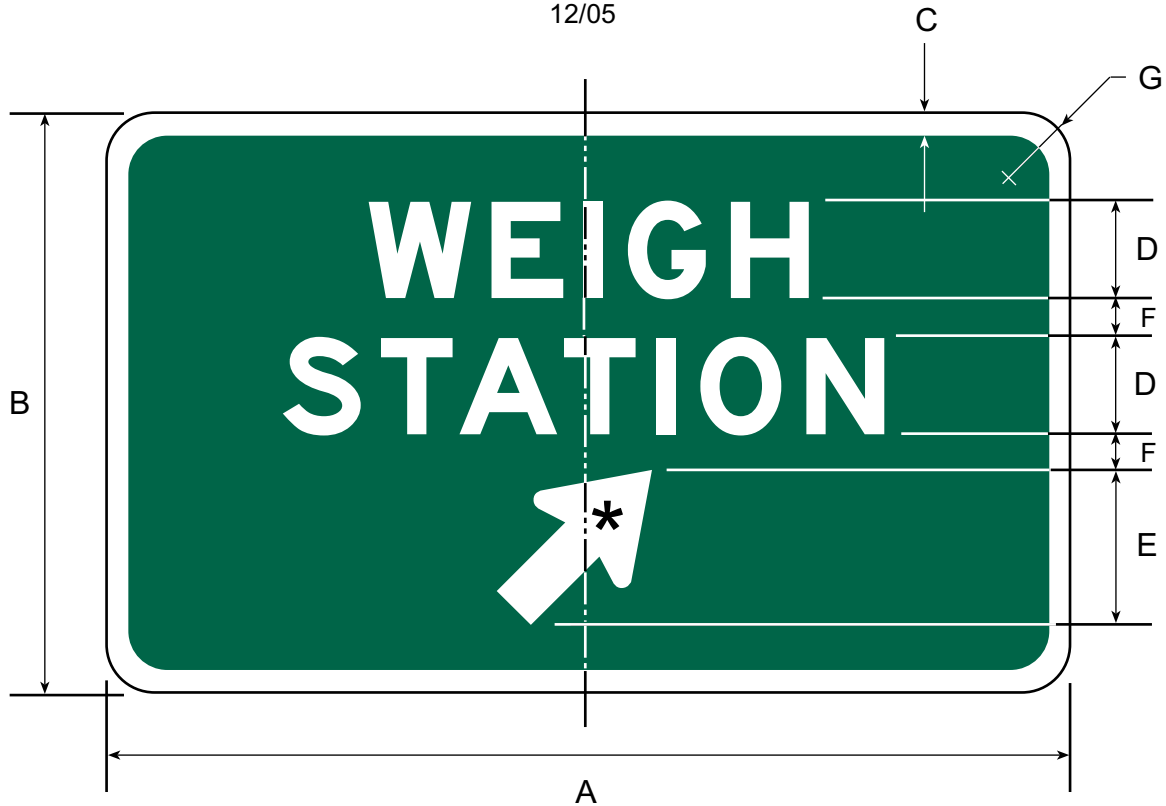

\* SEE APPENDIX FOR STANDARD ARROW DETAILS

DIMENSIONS (MILLIMETERS)						
A	B	C	D	E	F	G
1200	1050	38	150E	NO.1	100	100
1500	1350	38	200E	NO.2	150	125
2100	1800	50	250E	NO.2	200	150

DIMENSIONS (INCHES)						
A	B	C	D	E	F	G
48	42	1 1/2	6E	NO.1	4	4
60	54	1 1/2	8E	NO.2	6	5
84	72	2	10E	NO.2	8	6

## COLORS

LEGEND — WHITE (REFL)  
BACKGROUND — GREEN (REFL)

# MOTORIST SERVICE & RECREATIONAL FACILITY SYMBOL SIGNS

6/00

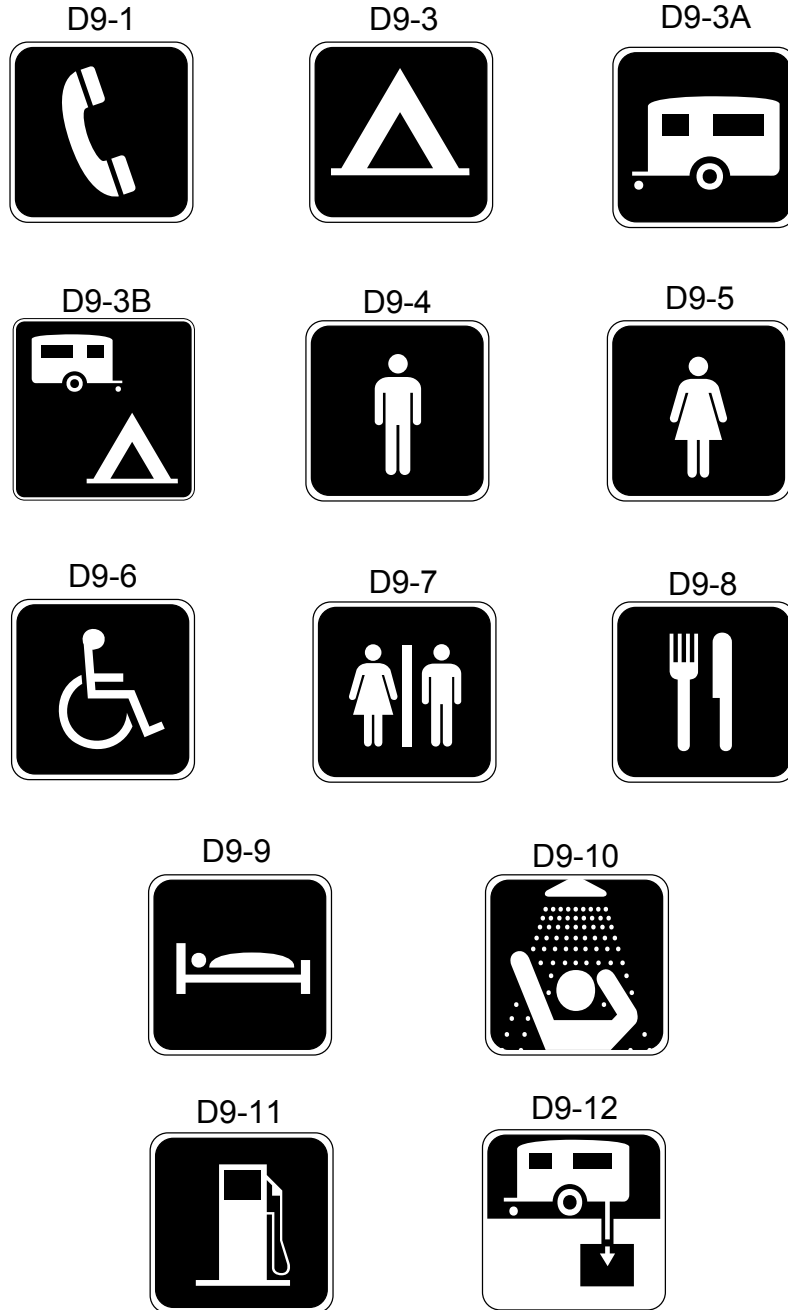

ALL SIGNS ARE 600 X 600mm. (24 X 24in)

NOTE: DESIGNERS SPECIFY MOTORIST SERVICE OR RECREATIONAL

## COLORS

SYMBOL — WHITE (REFL)

MOTORIST SERVICE: BACKGROUND — BLUE (REFL)

RECREATIONAL: BACKGROUND — BROWN (REFL)



# D9-1

10/97

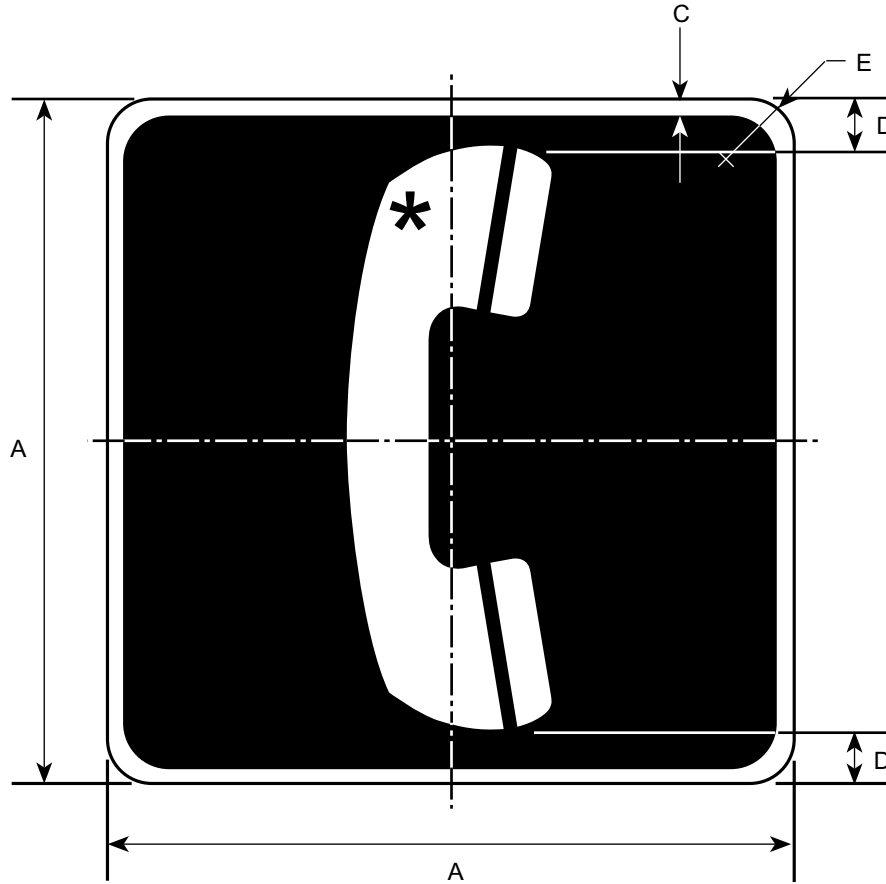

\* SEE APPENDIX FOR SYMBOL DESIGN

DIMENSIONS (MILLIMETERS)			
A	C	D	E
450	13	25	38
600	13	38	38
750	19	50	47

DIMENSIONS (INCHES)			
A	C	D	E
18	1/2	1	1 1/2
24	1/2	1 1/2	1 1/2
30	3/4	2	1 7/8

## COLORS

LEGEND — WHITE (REFL)  
BACKGROUND — BLUE