



**Washington State  
Department of Transportation**

---

# Materials Manual

M 46-01.47

March 2025

**Engineering and Regional Operations**  
State Materials Laboratory

# Foreword

---

The *Materials Manual* continues to use AASHTO, ASTM, WAQTC, and WSDOT test methods. The strategic direction for the Materials Laboratory is to continue to expand the use of AASHTO and ASTM standards whenever possible.

The manual has retained its dual unit format. However, English units predominate with metric units in parenthesis. WSDOT is using English units. The manual reflects the Quality System concerns of an AASHTO accredited organization and is organized by numerical test order. It also features two contents and an index.

The manual reflects a continuing policy of adopting “consensus” standards wherever practical. Adoption of these, in the form of AASHTO, ASTM, WAQTC, or other nationally recognized standards eliminates much of the previous text, which merely recopied the national documents. By adopting these standards, we provide a common standard that can be used by neighboring states and other laboratories or organizations. Contractors who work in more than one state also benefit by having to conform with fewer unique tests.

The concept of Field Operating Procedures (FOP) is continued to support the work of Materials Testers at the Field or Project level. Full procedures are provided when WSDOT Test Methods apply, or when a consensus standard (AASHTO, ASTM, or WAQTC) has been adapted to an FOP. The FOP provides the essential performance elements for the field technician.

When not specified by the test procedure, test reports will be generated through the Materials Testing System (MATS) or by the use of forms approved by the State Materials Engineer.

The WSDOT Materials Laboratory is responsible for establishing and managing all test procedures. For technical information or suggested changes to test methods or procedures, contact the WSDOT Materials Laboratory Quality Systems Manager through the departmental mail system at MS 47365; by mail at PO Box 47365, Olympia, WA 98504-7365; by email at [mawdslr@wsdot.wa.gov](mailto:mawdslr@wsdot.wa.gov); by telephone at 360-709-5497; or by fax at 360-709-5588, physically located at 1655 South Second Avenue, Tumwater, WA 98512. Please use this physical address for all communications other than U.S. Postal Service mail.

This manual is updated as needed. To order printed copies, go to:

[www.wsdot.wa.gov/publications/manuals/orderinformation.htm](http://www.wsdot.wa.gov/publications/manuals/orderinformation.htm)

To view electronic copies, go to:

[www.wsdot.wa.gov/publications/manuals/m46-01.htm](http://www.wsdot.wa.gov/publications/manuals/m46-01.htm)

Kurt R. Williams, P.E.  
State Materials Engineer

# Contents

Aggregate				
Procedure Number	Owner	Field Use	In Manual	Test Method
T 11	AASHTO			Materials Finer Than 0.075 mm (No. 200) Sieve in Mineral Aggregates by Washing
T 19	AASHTO	✓	✓	Bulk Density (“Unit Weight”) and Voids in Aggregate (Rodding Procedure Only) (Checklist Only)
T 21	AASHTO			Organic Impurities in Fine Aggregates for Concrete
T 27	AASHTO			Sieve Analysis of Fine and Coarse Aggregates
T 27_T 11	WAQTC	✓	✓	FOP for AASHTO T 27_T 11, Sieve Analysis of Fine and Coarse Aggregates
T 37	AASHTO			Sieve Analysis of Mineral Filler for Hot Mix Asphalt (HMA)
R 76	AASHTO			Reducing Samples of Aggregate to Testing Size
R 76	WAQTC	✓	✓	FOP for AASHTO R 76, Reducing Samples of Aggregate to Testing Size
T 84	AASHTO			Specific Gravity and Absorption of Fine Aggregates
T 85	AASHTO			Specific Gravity and Absorption of Coarse Aggregate
T 85	WAQTC	✓	✓	FOP for AASHTO T 85, Specific Gravity and Absorption of Coarse Aggregate
R 90	AASHTO			Sampling Aggregate Products
R 90	WAQTC	✓	✓	FOP for AASHTO R 90, Sampling Aggregate Products
T 96	AASHTO			Resistance to Degradation of Small-Size Coarse Aggregate by Abrasion and Impact in the Los Angeles Machine
T 112	AASHTO		✓	Clay Lumps and Friable Particles in Aggregate
T 113	WSDOT		✓	Method of Test for Determination of Degradation Value
T 123	WSDOT	✓	✓	Method of Test for Bark Mulch
T 125	WSDOT		✓	Determination of Fiber Length Percentages in Wood Strand Mulch
T 126	WSDOT		✓	Determination of Fiber Length Percentages in Hydraulically-Applied Erosion Control Products
SOP 128	WSDOT	✓	✓	Sampling for Aggregate Source Approval
T 176	AASHTO			Plastic Fines in Graded Aggregates and Soils by Use of the Sand Equivalent Test
T 176	WAQTC	✓	✓	FOP for AASHTO T 176, Plastic Fines in Graded Aggregates and Soils by the Use of the Sand Equivalent Test
T 255	AASHTO			Total Evaporable Moisture Content of Aggregate by Drying
T 255	WAQTC	✓	✓	FOP for AASHTO T 255, Total Evaporable Moisture Content of Aggregate by Drying
T 288	AASHTO		✓	Determining Minimum Laboratory Soil Resistivity (Checklist Only)
T 289	AASHTO			Determining pH of Soil for Use in Corrosion Testing
T 304	AASHTO			Uncompacted Void Content of Fine Aggregate
T 304	WAQTC	✓	✓	FOP for AASHTO T 304, Uncompacted Void Content of Fine Aggregate
T 335	AASHTO			Determining the Percentage of Fracture in Coarse Aggregate
T 335	WAQTC	✓	✓	FOP for AASHTO T 335, Determining the Percentage of Fracture in Coarse Aggregate
T 417	WSDOT		✓	Method of Test for Determining Minimum Resistivity and pH of Soil and Water
T 716	WSDOT	✓	✓	Method of Random Sampling for Locations of Testing and Sampling Sites

Bituminous Cement				
Procedure Number	Owner	Field Use	In Manual	Test Method
R 28	AASHTO			Standard Practice for Accelerated Aging of Asphalt Binder Using a Pressurized Aging Vessel
R 29	AASHTO			Standard Practice for Grading or Verifying the Performance Grade (PG) of an Asphalt Binder
T 44	AASHTO			Solubility of Bituminous Materials
T 48	AASHTO			Flash and Fire Points by Cleveland Open Cup
T 49	AASHTO			Penetration of Bituminous Materials
T 50	AASHTO			Float Test for Bituminous Materials
T 51	AASHTO			Ductility of Asphalt Materials
T 53	AASHTO			Softening Point of Bitumen (Ring-and-Ball Apparatus)
T 59	AASHTO			Emulsified Asphalts
R 66	AASHTO			Sampling Asphalt Materials
R 66	WAQTC	✓	✓	FOP for AASHTO R 66, Sampling Asphalt Materials
E 70	ASTM			pH of Aqueous Solutions With the Glass Electrode
T 72	AASHTO			Saybolt Viscosity
T 228	AASHTO			Specific Gravity of Semi-Solid Asphalt Materials
T 240	AASHTO			Effect of Heat and Air on a Moving Film of Asphalt Binder (Rolling Thin-Film Oven Test)
T 301	AASHTO			Elastic Recovery Test of Asphalt Materials by Means of a Ductilometer
T 313	AASHTO			Determining the Flexural Creep Stiffness of Asphalt Binder Using the Bending Beam Rheometer (BBR)
T 315	AASHTO			Determining the Rheological Properties of Asphalt Binder Using a Dynamic Shear Rheometer (DSR)
T 316	AASHTO			Viscosity Determination of Asphalt Binder Using Rotational Viscometer
SOP 318	WSDOT		✓	Standard Operating Procedure for Melting of Flexible Bituminous Pavement Marker Adhesive for Evaluation
T 350	AASHTO			Multiple Stress Creep Recovery (MSCR) Test of Asphalt Binder Using a Dynamic Shear Rheometer (DSR)
T 426	WSDOT		✓	Pull-Off Test for Hot Melt Traffic Button Adhesive
D 3111	ASTM			Flexibility Determination of Hot-Melt Adhesives by Mandrel Bend Test Method

Asphalt Mixture				
Procedure Number	Owner	Field Use	In Manual	Test Method
R 30	AASHTO			Standard Practice for Mixture Conditioning of Hot Mix Asphalt (HMA)
T 30	AASHTO			Mechanical Analysis of Extracted Aggregate
T 30	WAQTC	✓	✓	FOP for AASHTO T 30, Mechanical Analysis of Extracted Aggregate
TM 13	WAQTC		✓	Volumetric Properties of Asphalt Mixtures
TM 14	WAQTC		✓	Laboratory Prepared Asphalt Mixture Specimens
T 37	AASHTO			Sieve Analysis of Mineral Filler of Hot Mix Asphalt (HMA)
R 47	AASHTO			Reducing Samples of Asphalt Mixtures to Testing Size
R 47	WAQTC	✓	✓	FOP for AASHTO R 47, Reducing Samples of Asphalt Mixtures to Testing Size
R 79	AASHTO			Vacuum Drying Compacted Asphalt Specimens
R 79	WAQTC	✓	✓	FOP for AASHTO R 79, Vacuum Drying Compacted Asphalt Specimens
R 96	AASHTO			Installation, Operation, and Maintenance of Ignition Furnaces
R 97	AASHTO			Sampling Asphalt Mixtures

Asphalt Mixture				
Procedure Number	Owner	Field Use	In Manual	Test Method
R 97	WAQTC	✓	✓	FOP for AASHTO R 97, Sampling Asphalt Mixtures
T 166	AASHTO			Bulk Specific Gravity ( $G_{mb}$ ) of Compacted Asphalt Mixtures Using Saturated Surface-Dry Specimens
T 166	WAQTC	✓	✓	FOP for AASHTO T 166, Bulk Specific Gravity ( $G_{mb}$ ) of Compacted Asphalt Mixtures Using Saturated Surface-Dry Specimens
T 209	AASHTO			Theoretical Maximum Specific Gravity ( $G_{mm}$ ) and Density of Asphalt Mixtures
T 209	WAQTC	✓	✓	FOP for AASHTO T 209, Theoretical Maximum Specific Gravity ( $G_{mm}$ ) and Density of Asphalt Mixtures
T 269	AASHTO			Percent Air Void in Compacted Dense and Open Asphalt Mixtures
T 308	AASHTO			Determining the Asphalt Binder Content of Asphalt Mixtures by the Ignition Method
T 308	WAQTC	✓	✓	FOP for AASHTO T 308, Determining the Asphalt Binder Content of Asphalt Mixtures by the Ignition Method
T 312	AASHTO			Preparing and Determining the Density of Asphalt Mixture Specimens by Means of the Superpave Gyratory Compactor
T 312	WSDOT	✓	✓	FOP for AASHTO T 312, Preparing and Determining the Density of Asphalt Mixture Specimens by Means of the Superpave Gyratory Compactor
T 324	AASHTO		✓	Hamburg Wheel-Track Testing of Compacted Asphalt Mixtures
T 329	AASHTO			Moisture Content of Asphalt Mixtures by Oven Method
T 329	WAQTC	✓	✓	FOP for AASHTO T 329, Moisture Content of Asphalt Mixtures by Oven Method
T 331	AASHTO			Bulk Specific Gravity ( $G_{mb}$ ) and Density of Compacted Asphalt Mixtures Using Automatic Vacuum Sealing Method
T 331	WAQTC	✓	✓	FOP for AASHTO T 331, Bulk Specific Gravity ( $G_{mb}$ ) and Density of Compacted Asphalt Mixtures Using Automatic Vacuum Sealing Method
T 355	AASHTO			In-Place Density of Asphalt Mixtures by Nuclear Methods
T 355	WAQTC	✓	✓	FOP for AASHTO T 355, In-Place Density of Asphalt Mixtures by Nuclear Methods
T 716	WSDOT	✓	✓	Method of Random Sampling for Locations of Testing and Sampling Sites
T 720	WSDOT		✓	Method of Test for Thickness Measurement of Hot Mix Asphalt (HMA) Cores
SOP 729	WSDOT	✓	✓	Standard Operating Procedure for Determination of the Moving Average of Theoretical Maximum Density (TMD) for HMA
SOP 730	WSDOT	✓	✓	Standard Operating Procedure for Correlation of Nuclear Gauge Densities With Hot Mix Asphalt (HMA) Cores
SOP 731	WSDOT	✓	✓	Standard Operating Procedure for Determining Volumetric Properties of Hot Mix Asphalt
SOP 732	WSDOT	✓	✓	Standard Operating Procedure for Volumetric Design for Hot-Mix Asphalt (HMA)
SOP 733	WSDOT	✓	✓	Standard Operating Procedure for Determination of Pavement Density Differentials Using the Nuclear Density Gauge
SOP 734	WSDOT	✓	✓	Standard Operating Procedure for Sampling Hot Mix Asphalt After Compaction (Obtaining Cores)
SOP 735	WSDOT	✓	✓	Standard Operating Procedure for Longitudinal Joint Density
SOP 736	WSDOT		✓	In-Place Density of Bituminous Mixes Using Cores
SOP 737	WSDOT		✓	Procedure for the Forensic Testing of HMA Field Cores
D 6931	ASTM		✓	Indirect Tensile (IDT) Strength of Asphalt Mixtures

Cement				
Procedure Number	Owner	Field Use	In Manual	Test Method
R 71	AASHTO			Sampling and Amount of Testing of Hydraulic Cement
T 105	AASHTO			Chemical Analysis of Hydraulic Cement
T 106	AASHTO			Compressive Strength of Hydraulic Cement Mortars (Using 50-mm or 2-in. Cube Specimens)
T 106	WSDOT	✓	✓	FOP for AASHTO for Compressive Strength of Hydraulic Cement Mortars (Using 2-in. or (50-mm) Cube Specimens)
T 107	AASHTO			Autoclave Expansion of Hydraulic Cement
T 129	AASHTO			Amount of Water Required for Normal Consistency of Hydraulic Cement Paste
T 131	AASHTO			Time of Setting of Hydraulic Cement by Vicat Needle
T 133	AASHTO			Density of Hydraulic Cement
T 137	AASHTO			Air Content of Hydraulic Cement Mortar
T 153	AASHTO			Fineness of Hydraulic Cement by Air Permeability Apparatus
T 162	AASHTO			Mechanical Mixing of Hydraulic Cement Pastes and Mortars of Plastic Consistency
T 192	AASHTO			Fineness of Hydraulic Cement by the 45- $\mu$ m (No. 325) Sieve
M 201	AASHTO			Mixing Rooms, Moist Cabinets, Moist Rooms, and Water Storage Tanks Used in the Testing of Hydraulic Cements and Concretes
T 260	AASHTO			Sampling and Testing for Chloride Ion in Concrete and Concrete Raw Materials
T 303	AASHTO			Accelerated Detection of Potentially Deleterious Expansion of Mortar Bars Due to Alkali-Silica Reaction
T 313	WSDOT		✓	Method of Test for Cement-Latex Compatibility
T 314	WSDOT		✓	Method of Test for Photovolt Reflectance
T 413	WSDOT		✓	Method of Test for Evaluating Waterproofing Effectiveness of Membrane and Membrane-Pavement Systems
T 813	WSDOT	✓	✓	Field Method of Fabrication of 2 in (50 mm) Cube Specimens for Compressive Strength Testing of Grouts and Mortars
T 814	WSDOT		✓	Method of Test for Water Retention Efficiency of Liquid Membrane-Forming Compounds and Impermeable Sheet Materials for Curing Concrete
C 939	WSDOT	✓	✓	FOP for ASTM for Flow of Grout for Preplaced-Aggregate Concrete (Flow Cone Method)

Chemical				
Procedure Number	Owner	Field Use	In Manual	Test Method
LRFD CONS	AASHTO			Section 18, Bearing Devices
M 111	AASHTO			Zinc (Hot-Dip Galvanized) Coatings on Iron and Steel Products
M 251	AASHTO			Plain and Laminated Elastomeric Bridge Bearings
T 65	AASHTO			Mass (Weight) of Coating on Iron and Steel Articles With Zinc or Zinc-Alloy Coatings
T 105/ C114	AASHTO			Chemical Analysis of Hydraulic Cement
T 260	AASHTO			Sampling and Testing for Chloride Ion in Concrete and Concrete Raw Materials
T 267	AASHTO			Determination of Organic Content in Soils by Loss on Ignition
C 109	ASTM			Compressive Strength of Hydraulic Cement Mortars (Using 2-in. or [50 mm] Cube Specimens)

Chemical				
Procedure Number	Owner	Field Use	In Manual	Test Method
C 311	ASTM			Sampling and Testing Fly Ash or Natural Pozzolans for Use in Portland Cement Concrete
C 579	ASTM			Compressive Strength of Chemical-Resistant Mortars, Grouts, Monolithic Surfacing, and Polymer Concretes
C 881	ASTM			Standard Specification for Epoxy-Resin-Base Bonding Systems for Concrete
C 882	ASTM		✓	Bond Strength of Epoxy-Resin Systems Used With Concrete By Slant Shear
D 638	ASTM			Tensile Properties of Plastics
D 695	ASTM			Compressive Properties of Rigid Plastics
D 792	ASTM			Density and Specific Gravity (Relative Density) of Plastics by Displacement
D 1751	ASTM			Preformed Expansion Joint Filler for Concrete Paving and Structural Construction (Nonextruding and Resilient Bituminous Types)
D 2240	ASTM			Rubber Property-Durometer Hardness
D 2628/ M 220	ASTM		✓	Preformed Polychloroprene Elastomeric Joint Seals for Concrete Pavements
D 5167	ASTM			Melting of Hot-Applied Joint and Crack Sealant and Filler for Evaluation
D 5329	ASTM			Sealants and Fillers, Hot-Applied, for Joints and Cracks in Asphalt Pavements and Portland Cement Concrete Pavements
D 6690	ASTM			Joint and Crack Sealants, Hot Applied, for Concrete and Asphalt Pavements
D 7091	ASTM		✓	Nondestructive Measurement of Dry Film Thickness of Nonmagnetic Coatings Applied to Ferrous Metals and Nonmagnetic, Nonconductive Coatings Applied to Non-Ferrous Metals

Concrete				
Procedure Number	Owner	Field Use	In Manual	Test Method
TM 2	WAQTC	✓	✓	WAQTC TM 2, Sampling Freshly Mixed Concrete
T 22	AASHTO			Compressive Strength of Cylindrical Concrete Specimens
T 22	WSDOT	✓	✓	FOP for AASHTO T 22, Compressive Strength of Cylindrical Concrete Specimens
T 24	AASHTO			Obtaining and Testing Drilled Cores and Sawed Beams of Concrete
R 39	AASHTO			Standard Practice for Making and Curing Concrete Test Specimens in the Laboratory
R 60	AASHTO			Sampling Freshly Mixed Concrete
R 100	AASHTO			Method of Making and Curing Concrete Test Specimens in the Field
R 100	WAQTC	✓	✓	FOP for AASHTO T 23, Method of Making and Curing Concrete Test Specimens in the Field
T 106	AASHTO			Compressive Strength of Hydraulic Cement Mortars (Using 50-mm or 2-in. Cube Specimens)
T 106	WSDOT	✓	✓	FOP for AASHTO for Compressive Strength of Hydraulic Cement Mortars (Using 2-in. or (50-mm) Cube Specimens)
T 119	AASHTO			Slump of Hydraulic Cement Concrete
T 119	WAQTC	✓	✓	FOP for AASHTO T 119, Slump of Hydraulic Cement Concrete
T 121	AASHTO			Density (Unit Weight), Yield, and Air Content (Gravimetric) of Concrete
T 121	WAQTC	✓	✓	FOP for AASHTO T 121, Density (Unit Weight), Yield, and Air Content (Gravimetric) of Concrete

Concrete				
Procedure Number	Owner	Field Use	In Manual	Test Method
C 140	ASTM			Sampling and Testing Concrete Masonry Units and Related Units
T 141	AASHTO			Sampling Freshly Mixed Concrete
T 152	AASHTO			Air Content of Freshly Mixed Concrete by the Pressure Method
T 152	WAQTC	✓	✓	FOP for AASHTO T 152, Air Content of Freshly Mixed Concrete by the Pressure Method
T 196	AASHTO		✓	Air Content of Freshly Mixed Concrete by the Volumetric Method (Checklist Only)
T 197	AASHTO			Time of Setting of Concrete Mixtures by Penetration Resistance
T 198	AASHTO			Splitting Tensile Strength of Cylindrical Concrete Specimens
M 201	AASHTO			Mixing Rooms, Moist Cabinets, Moist Rooms, and Water Storage Tanks Used in the Testing of Hydraulic Cements and Concretes
T 231	AASHTO			Capping Cylindrical Concrete Specimens
T 231	WSDOT	✓	✓	FOP for AASHTO T 231, Capping Cylindrical Concrete Specimens
T 260	AASHTO			Sampling and Testing for Chloride Ion in Concrete and Concrete Raw Materials
T 277	AASHTO			Electrical Indication of Concrete's Ability to Resist Chloride Ion Penetration
T 309	AASHTO			Temperature of Freshly Mixed Portland Cement Concrete
T 309	WAQTC	✓	✓	FOP for AASHTO T 309, Temperature of Freshly Mixed Portland Cement Concrete
T 359	AASHTO			Pavement Thickness by Magnetic Pulse Induction
C 457	ASTM			Microscopical Determination of Parameters of the Air-Void System in Hardened Concrete
C 495	ASTM			Compressive Strength of Lightweight Insulated Concrete
T 716	WSDOT	✓	✓	Method of Random Sampling for Locations of Testing and Sampling Sites
T 802	WSDOT	✓	✓	Method of Test for Flexural Strength of Concrete (Using Simple Beam With Center-Point Loading)
C 805	ASTM			Rebound Number of Hardened Concrete
C 805	WSDOT	✓	✓	Rebound Hammer Determination of Compressive Strength of Hardened Concrete
T 808	WSDOT	✓	✓	Method for Making Flexural Test Beams
T 813	WSDOT	✓	✓	Field Method of Fabrication of 2 in (50 mm) Cube Specimens for Compressive Strength Testing of Grouts and Mortars
T 818	WSDOT		✓	Air Content of Freshly Mixed Self-Compacting Concrete by the Pressure Method
T 819	WSDOT		✓	Making and Curing Self-Compacting Concrete Test Specimens in the Field
C 939	ASTM			Flow of Grout for Preplaced-Aggregate Concrete (Flow Cone Method)
C 939	WSDOT	✓	✓	FOP for ASTM C 939. Flow of Grout for Preplaced-Aggregate Concrete (Flow Cone Method)
C 1218	ASTM			Water-Soluble Chloride in Mortar and Concrete
C 1231	ASTM			Use of Unbonded Caps in Determination of Compressive Strength of Hardened Cylindrical Concrete Specimens
C 1231	WSDOT	✓	✓	FOP for ASTM C1231, Use of Unbonded Caps in Determination of Compressive Strength of Hardened Cylindrical Concrete Specimens
D 1429	ASTM			Specific Gravity of Water and Brine
C 1604	ASTM			Obtaining and Testing Drilled Cores of Shotcrete
C 1611	WSDOT	✓	✓	FOP for ASTM C 1611/C 1611M Standard Test Method for Slump Flow of Self-Consolidating Concrete
C 1621	WSDOT	✓	✓	FOP for ASTM C 1621/C 1621M Standard Test Method for Passing Ability of Self-Consolidating Concrete by J-Ring



Electrical				
Procedure Number	Owner	Field Use	In Manual	Test Method
IP 78-16	FHWA			Type 170 Signal Controller System Hardware Specification
TEES	Caltrans			Caltrans Transportation Electrical Equipment Specifications
PE-1	NEMA			Standards Publication: Uninterruptible Power Systems (UPS) – Specification and Performance Verification
TS-1	NEMA			Standards Publication: Traffic Control Systems
TS-2	NEMA			Standards Publication: Traffic Controller Assemblies with NTCIP Requirements
T 421	WSDOT		✓	Traffic Controller Inspection Procedure
T 422	WSDOT		✓	Transient Voltage Test (Spike Test) Procedure (optional)
T 423	WSDOT		✓	Conflict Monitor Test Procedure
T 424	WSDOT		✓	Power Interruption Test Procedure
T 425	WSDOT		✓	Environmental Chamber Test Procedure
T 427	WSDOT		✓	Loop Amplifier Test Procedure
T 428	WSDOT		✓	Traffic Controller Compliance Inspection and Test Procedure
SOP 429	WSDOT		✓	Methods for Determining the Acceptance of Traffic Signal Controller Assemblies
T 430	WSDOT		✓	Uninterruptible Power Supply (UPS) System Compliance Inspection and Test Procedure
1188	IEEE			Standards Publication: Recommended Practice for Maintenance, Testing, and Replacement of Valve-Regulated Lead-Acid (VRLA) batteries for Stationary Applications
ATC 5301	AASHTO ITE NEMA			Publication: Advanced Transportation Controller (ATC) Cabinet Standard
62040-3	IEC			Standards Publication: Uninterruptible Power Systems (UPS) – Method for specifying the performance and test requirements

<b>Geotechnical – Soils</b>				
<b>Procedure Number</b>	<b>Owner</b>	<b>Field Use</b>	<b>In Manual</b>	<b>Test Method</b>
R 58	AASHTO			Dry Preparation of Disturbed Soil and Soil Aggregate Samples for Test
R 74	AASHTO			Wet Preparation of Disturbed Soil Samples for Test
R 75	AASHTO			Developing Soil Moisture-Density Relations
R 75	WAQTC	✓	✓	FOP for AASHTO R 75, Developing Moisture-Density Relations
T 88	AASHTO			Particle Size Analysis of Soils
T 89	AASHTO			Determining the Liquid Limit of Soils
T 89	WAQTC		✓	FOP for AASHTO T 89, Determining the Liquid Limit of Soils
T 90	AASHTO			Determining the Plastic Limit and Plasticity Index of Soils
T 90	WAQTC		✓	FOP for AASHTO T 90, Determining the Plastic Limit and Plasticity Index of Soils
T 99	AASHTO			Moisture-Density Relations of Soils Using a 2.5 kg (5.5 lb) Rammer and a 305 mm (12 in.) Drop
T 99	WAQTC	✓	✓	FOP for AASHTO T 99, Moisture-Density Relations of Soils Using a 2.5 kg (5.5 lb) Rammer and a 305 mm (12 in.) Drop
T 100	AASHTO			Specific Gravity of Soils
T 180	AASHTO			Moisture-Density Relations of Soils Using a 4.54 kg (10 lb) Rammer and a 457 mm (18 in.) Drop
T 180	WAQTC	✓	✓	FOP for AASHTO T 180, Moisture-Density Relations of Soils Using a 4.54 kg (10 lb) Rammer and a 457 mm (18 in.) Drop
T 208	AASHTO			Unconfined Compressive Strength of Cohesive Soil
T 215	AASHTO			Permeability of Granular Soils (Constant Head)
T 216	AASHTO			One-Dimensional Consolidation Properties of Soils
T 236	AASHTO			Direct Shear Test of Soils Under Consolidated Drained Conditions
T 265	AASHTO			Laboratory Determination of Moisture Content of Soils
T 265	WAQTC	✓	✓	FOP for AASHTO T 265, Laboratory Determination of Moisture Content of Soils
T 288	AASHTO			Determining Minimum Laboratory Soil Resistivity
T 296	AASHTO			Unconsolidated, Undrained Compressive Strength of Cohesive Soils in Triaxial Compression
T 297	AASHTO			Consolidated, Undrained Triaxial Compressive Test on Cohesive Soils Shear
T 501	WSDOT		✓	Test Method to Determine Durability of Very Weak Rock
D 1140	ASTM			Determining the Amount of Material Finer than 75-µm (No. 200) Sieve in Soils by Washing
D 2487	ASTM			Standard Practice for Classification of Soils for Engineering Purposes (Unified Soil Classification System)
D 2488	ASTM			Standard Practice for Description and Identification of Soils (Visual-Manual Procedure)
D 4186	ASTM			One-Dimensional Consolidation Properties of Saturated Cohesive Soils Using Controlled-Strain Loading
D 4543	ASTM			Preparing Rock Core as Cylindrical Test Specimens and Verifying Conformance to Dimensional and Shape Tolerances
D 4644	ASTM			Slake Durability of Shales and Similar Weak Rocks
D 4767	ASTM			Standard Test Method for Consolidated Undrained Triaxial Compression Test for Cohesive Soils
D 5084	ASTM			Measurement of Hydraulic Conductivity of Saturated Porous Materials Using a Flexible Wall Permeameter

Geotechnical – Soils				
Procedure Number	Owner	Field Use	In Manual	Test Method
D 5311	ASTM			Load Controlled Cyclic Triaxial Strength of Soil
D 5731	ASTM			Determination of the Point Load Strength Index of Rock and Application to Rock Strength Classifications
D 6467	ASTM			Torsional Ring Shear Test to Determine Drained Residual Shear Strength of Cohesive Soils
D 6528	ASTM			Consolidated Undrained Direct Simple Shear Testing of Cohesive Soils
D 7012	ASTM		✓	Compressive Strength and Elastic Moduli of Intact Rock Core Specimens under Varying States of Stress and Temperatures

Geotextile and Steel				
Procedure Number	Owner	Field Use	In Manual	Test Method
E 18	ASTM			Rockwell Hardness of Metallic Materials
A 143	ASTM			Standard Practice for Safeguarding Against Embrittlement of Hot-Dip Galvanized Structural Steel Products and Procedure for Detecting Embrittlement
T 244	AASHTO			Mechanical Testing of Steel Products
T 285	AASHTO			Bend Test for Bars for Concrete Reinforcement
A 370	ASTM			Definitions for Mechanical Testing of Steel Products
E 290	ASTM			Standard Test Methods for Bend Testing of Material for Ductility
F 606	ASTM			Determining the Mechanical Properties of Externally and Internally Threaded Fasteners, Washers, Direct Tension Indicators, and Rivets
A 615	ASTM			Standard Specification for Deformed and Plain Carbon-Steel Bars for Concrete Reinforcement
SOP 914	WSDOT	✓	✓	Practice for Sampling of Geosynthetic Material for Testing
T 915	WSDOT		✓	Practice for Conditioning of Geotextiles for Testing
T 923	WSDOT		✓	Thickness Measurement of Geotextiles
T 925	WSDOT		✓	Standard Practice for Determination of Long-Term Strength for Geosynthetic Reinforcement
T 926	WSDOT		✓	Geogrid Brittleness Test
D 1683	ASTM			Failure in Sewen Seams of Woven Fabrics
D 4354	ASTM		✓	Standard Practice for Sampling of Geosynthetics and Rolled Erosion Control Products (RECPs) for Testing
D 4355	ASTM			Deterioration of Geotextiles From Exposure to Light, Moisture and Heat in a Xenon-Arc-Type Apparatus
D 4491	ASTM			Water Permeability of Geotextiles by permittivity
D 4533	ASTM			Trapezoid Tearing Strength of Geotextiles

Geotextile and Steel				
Procedure Number	Owner	Field Use	In Manual	Test Method
D 4595	ASTM			Tensile Properties of Geotextiles by the Wide-Width Strip Method
D 4632	ASTM			Grab Breaking Load and Elongation of Geotextiles
D 4751	ASTM			Determining Apparent Opening Size of a Geotextiles
D 6241	ASTM			Static Puncture Strength of Geotextiles and Geotextile-Related Products Using a 50-mm Probe

Paint				
Procedure Number	Owner	Field Use	In Manual	Test Method
D 523	ASTM			Specular Gloss
D 823	ASTM			Producing Films of Uniform Thickness of Paint, Coatings and Related Products on Test Panels
D 1475	ASTM			Density of Liquid Coatings, Inks, and Related Products
D 2244	ASTM			Standard Practice for Calculation of Color Tolerances and Color Differences From Instrumentally Measured Color Coordinates
D 2369	ASTM			Volatile Content of Coatings
D 2621	ASTM			Infrared Identification of Vehicle Solids From Solvent-Reducible Paints
D 2697	ASTM			Volume Nonvolatile Matter in Clear or Pigmented Coatings
D 2698	ASTM			Determination of the Pigment Content of Solvent-Reducible Paints by High-Speed Centrifuging

Pavement Soils				
Procedure Number	Owner	Field Use	In Manual	Test Method
TM 15	WAQTC		✓	Laboratory Theoretical Maximum Dry Density of Granular Soil and Soil/Aggregate
T 242	AASHTO			Frictional Properties of Paved Surfaces Using a Full-Scale Tire
T 272	AASHTO			One-Point Method for Determining Maximum Dry Density and Optimum Moisture
T 272	WAQTC	✓	✓	FOP for AASHTO T 272, One-Point Method for Determining Maximum Dry Density and Optimum Moisture
T 310	AASHTO			In-Place Density and Moisture Content of Soil and Soil-Aggregate by Nuclear Methods (Shallow Depth)
T 310	WAQTC	✓	✓	FOP for AASHTO T 310, In-Place Density and Moisture Content of Soil and Soil-Aggregate by Nuclear Methods (Shallow Depth)
T 610	WSDOT		✓	Method of Test for the Capillary Rise of Soils
SOP 615	WSDOT	✓	✓	Determination of the % Compaction for Embankment & Untreated Surfacing Materials Using the Nuclear Moisture-Density Gauge
SOP 738	WSDOT	✓	✓	Establishing Maximum Field Density for Recycled Concrete Aggregates by Test Point Evaluation
T 807	WSDOT	✓	✓	Method of Operation of California Profilograph and Evaluation of Profiles
D 4694	ASTM			Deflections with a Falling-Weight-Type Impulse Load Device

Standard Practice				
Procedure Number	Owner	Field Use	In Manual	Test Method
QC 1	WSDOT		✓	Standard Practice for Cement Producers/Suppliers That Certify Portland Cement and Blended Hydraulic Cement
QC 2	WSDOT		✓	Standard Practice for Asphalt Suppliers That Certify Performance Graded and Emulsified Asphalts
QC 3	WSDOT		✓	Quality System Laboratory Review
QC 4	WSDOT		✓	Standard Practice for Fly Ash and Natural Pozzolan Producers/Importers/Distributors That Certify Fly Ash and Natural Pozzolan
QC 5	WSDOT		✓	Standard Practice for Ground Granulated Blast-Furnace Slag Producers/Importers/Distributors That Certify Ground Granulated Blast-Furnace Slag
QC 6	WSDOT		✓	Annual Prestressed Plant Review and Approval Process
QC 7	WSDOT		✓	Annual Precast Plant Review and Approval Process
QC 8	WSDOT		✓	Standard Practice for Development, Submittal and Approval of Hot Mix Asphalt Mix Designs
QC 9	WSDOT		✓	Standard Practice for Approval of Recycled Materials Facilities of WSDOT Recycled Concrete and Returned Concrete
QC 10	WSDOT		✓	Standard Practice for Approval of Recycled Materials Facilities from Stockpiles of Unknown Sources
QC 11	WSDOT		✓	Vacant
QC 12	WSDOT		✓	Standard Practice for Evaluation of Aggregate Sources

Numerical Order				
Procedure Number	Owner	Field Use	In Manual	Test Method
LRFD CONS	AASHTO			Section 18, Bearing Devices
QC 1	WSDOT		✓	Standard Practice for Cement Producers/Suppliers That Certify Portland Cement and Blended Hydraulic Cement
QC 2	WSDOT		✓	Standard Practice for Asphalt Suppliers That Certify Performance Graded and Emulsified Asphalts
QC 3	WSDOT		✓	Quality System Laboratory Review
QC 4	WSDOT		✓	Standard Practice for Fly Ash and Natural Pozzolan Producers/Importers/Distributors That Certify Fly Ash and Natural Pozzolan
QC 5	WSDOT		✓	Standard Practice for Ground Granulated Blast-Furnace Slag Producers/Importers/Distributors That Certify Ground Granulated Blast-Furnace Slag
QC 6	WSDOT		✓	Annual Prestressed Plant Review and Approval Process
QC 7	WSDOT		✓	Annual Precast Plant Review and Approval Process
QC 8	WSDOT		✓	Standard Practice for Development, Submittal and Approval of Hot Mix Asphalt Mix Designs
QC 9	WSDOT		✓	Standard Practice for Approval of Recycled Materials Facilities of WSDOT Recycled Concrete and Returned Concrete
QC 10	WSDOT		✓	Standard Practice for Approval of Recycled Materials Facilities from Stockpiles of Unknown Sources
QC 11	WSDOT		✓	Vacant
QC 12	WSDOT		✓	Standard Practice for Evaluation of Aggregate Sources
TEES	Caltrans			Caltrans Transportation Electrical Equipment Specifications
PE-1	NEMA			Standards Publication: Uninterruptible Power Systems (UPS) – Specification and Performance Verification
TS-1	NEMA			Standards Publication: Traffic Control Systems
TS-2	NEMA			Standards Publication: Traffic Controller Assemblies with NTCIP Requirements
TM 2	WAQTC	✓	✓	WAQTC TM 2, Sampling Freshly Mixed Concrete
T 11	AASHTO			Materials Finer Than 0.075 mm (No. 200) Sieve in Mineral Aggregates by Washing
TM 13	WAQTC		✓	Volumetric Properties of Asphalt Mixtures
TM 14	WAQTC		✓	Laboratory Prepared Asphalt Mixture Specimens
TM 15	WAQTC		✓	Laboratory Theoretical Maximum Dry Density of Granular Soil and Soil/Aggregate
E 18	ASTM			Rockwell Hardness of Metallic Materials
R 18	AASHTO			Establishing and Implementing a Quality Management System for Construction Materials Testing Laboratories
T 19	AASHTO	✓	✓	Bulk Density (“Unit Weight”) and Voids in Aggregate (Rodding Procedure Only) (Checklist Only)
T 21	AASHTO			Organic Impurities in Fine Aggregates for Concrete
T 22	AASHTO			Compressive Strength of Cylindrical Concrete Specimens
T 22	WSDOT	✓	✓	FOP for AASHTO T 22, Compressive Strength of Cylindrical Concrete Specimens
T 24	AASHTO			Obtaining and Testing Drilled Cores and Sawed Beams of Concrete
T 27	AASHTO			Sieve Analysis of Fine and Coarse Aggregates
T 27_T 11	WAQTC	✓	✓	FOP for AASHTO T 27_T 11, Sieve Analysis of Fine and Coarse Aggregates
R 28	AASHTO			Standard Practice for Accelerated Aging of Asphalt Binder Using a Pressurized Aging Vessel

Numerical Order				
Procedure Number	Owner	Field Use	In Manual	Test Method
R 29	AASHTO			Standard Practice for Grading or Verifying the Performance Grade (PG) of an Asphalt Binder
R 30	AASHTO			Standard Practice for Mixture Conditioning of Hot Mix Asphalt (HMA)
T 30	AASHTO			Mechanical Analysis of Extracted Aggregate
T 30	WAQTC	✓	✓	FOP for AASHTO T 30, Mechanical Analysis of Extracted Aggregate
T 37	AASHTO			Sieve Analysis of Mineral Filler for Hot Mix Asphalt (HMA)
R 39	AASHTO			Standard Practice for Making and curing Concrete Test Specimens in the Laboratory
T 44	AASHTO			Solubility of Bituminous Materials
R 47	AASHTO			Reducing Samples of Asphalt Mixtures to Testing Size
R 47	WAQTC	✓	✓	FOP for AASHTO R 47, Reducing Samples of Asphalt Mixtures to Testing Size
T 48	AASHTO			Flash and Fire Points by Cleveland Open Cup
T 49	AASHTO			Penetration of Bituminous Materials
T 50	AASHTO			Float Test for Bituminous Materials
T 51	AASHTO			Ductility of Asphalt Materials
T 53	AASHTO			Softening Point of Bitumen (Ring-and-Ball Apparatus)
R 58	AASHTO			Dry Preparation of Disturbed Soil and Soil Aggregate Samples for Test
T 59	AASHTO			Emulsified Asphalts
R 60	AASHTO			Sampling Freshly Mixed Concrete
T 65	AASHTO			Mass (Weight) of Coating on Iron and Steel Articles With Zinc or Zinc-Alloy Coatings
R 66	AASHTO			Sampling Asphalt Materials
R 66	WAQTC	✓	✓	FOP for AASHTO R 66, Sampling Asphalt Materials
E 70	ASTM			pH of Aqueous Solutions With the Glass Electrode
R 71	AASHTO			Sampling and Amount of Testing of Hydraulic Cement
T 72	AASHTO			Saybolt Viscosity
R 74	AASHTO			Wet Preparation of Disturbed Soil Samples for Test
R 75	AASHTO			Developing Soil Moisture-Density Relations
R 75	WAQTC	✓	✓	FOP for AASHTO R 75, Developing Moisture-Density Relations
R 76	AASHTO			Reducing Samples of Aggregate to Testing Size
R 76	WAQTC	✓	✓	FOP for AASHTO R 76, Reducing Samples of Aggregate to Testing Size
IP 78-16	FHWA			Type 170 Signal Controller System Hardware Specification
R 79	AASHTO			Vacuum Drying Compacted Asphalt Specimens
R 79	WAQTC	✓	✓	FOP for AASHTO R 79, Vacuum Drying Compacted Asphalt Specimens
T 84	AASHTO			Specific Gravity and Absorption of Fine Aggregates
T 85	AASHTO			Specific Gravity and Absorption of Coarse Aggregates
T 85	WAQTC	✓	✓	FOP for AASHTO T 85, Specific Gravity and Absorption of Coarse Aggregate
T 88	AASHTO			Particle Size Analysis of Soils
T 89	AASHTO			Determining the Liquid Limit of Soils
T 89	WAQTC		✓	FOP for AASHTO T 89, Determining the Liquid Limit of Soils
R 90	AASHTO			Sampling Aggregate Products
R 90	WAQTC	✓	✓	FOP for AASHTO R 90, Sampling Aggregate Products
T 90	AASHTO			Determining the Plastic Limit and Plasticity Index of Soils
T 90	WAQTC		✓	FOP for AASHTO T 90, Determining the Plastic Limit and Plasticity Index of Soils
R 96	AASHTO			Installation, Operation, and Maintenance of Ignition Furnaces

Numerical Order				
Procedure Number	Owner	Field Use	In Manual	Test Method
T 96	AASHTO			Resistance to Degradation of Small-Size Coarse Aggregate by Abrasion and Impact in the Los Angeles Machine
R 97	AASHTO			Sampling Asphalt Mixtures
R 97	WAQTC	✓	✓	FOP for AASHTO R 97, Sampling Asphalt Mixtures
T 99	AASHTO			Moisture-Density Relations of Soils Using a 2.5 kg (5.5 lb) Rammer and a 305 mm (12 in.) Drop
T 99	WAQTC	✓	✓	FOP for AASHTO T 99, Moisture-Density Relations of Soils Using a 2.5 kg (5.5 lb) Rammer and a 305 mm (12 in.) Drop
R 100	AASHTO			Method of Making and Curing Concrete Test Specimens in the Field
R 100	WAQTC	✓	✓	FOP for AASHTO T 23, Method of Making and Curing Concrete Test Specimens in the Field
T 100	AASHTO			Specific Gravity of Soils
T 105	AASHTO			Chemical Analysis of Hydraulic Cement
T 106	AASHTO			Compressive Strength of Hydraulic Cement Mortars (Using 50-mm or 2-in Cube Specimens)
T 106	WSDOT	✓	✓	FOP for AASHTO for Compressive Strength of Hydraulic Cement Mortars (Using 2-in. or (50-mm) Cube Specimens)
T 107	AASHTO			Autoclave Expansion of Hydraulic Cement
M 111	AASHTO			Zinc (Hot-Dip Galvanized) Coatings on Iron and Steel Products
T 112	AASHTO		✓	Clay Lumps and Friable Particles in Aggregate
T 113	WSDOT		✓	Method of Test for Determination of Degradation Value
T 119	AASHTO			Slump of Hydraulic Cement Concrete
T 119	WAQTC	✓	✓	FOP for AASHTO T 119, Slump of Hydraulic Cement Concrete
T 121	AASHTO			Density (Unit Weight), Yield, and Air Content (Gravimetric) of Concrete
T 121	WAQTC	✓	✓	FOP for AASHTO T 121, Density (Unit Weight), Yield, and Air Content (Gravimetric) of Concrete
T 123	WSDOT	✓	✓	Method of Test for Bark Mulch
T 125	WSDOT		✓	Determination of Fiber Length Percentages in Wood Strand Mulch
T 126	WSDOT		✓	Determination of Fiber Length Percentages in Hydraulically-Applied Erosion Control Products
T 127	WSDOT		✓	Preparation of Leachate Sample for Testing Toxicity of HECF Effluents
SOP 128	WSDOT	✓	✓	Sampling for Aggregate Source Approval
T 129	AASHTO			Amount of Water Required for Normal Consistency of Hydraulic Cement Paste
T 131	AASHTO			Time of Setting of Hydraulic Cement by Vicat Needle
T 133	AASHTO			Density of Hydraulic Cement
T 137	AASHTO			Air Content of Hydraulic Cement Mortar
C 140	ASTM			Sampling and Testing Concrete Masonry Units and Related Units
T 141	AASHTO			Sampling Freshly Mixed Concrete
A 143	ASTM			Standard Practice for Safeguarding Against Embrittlement of Hot-Dip Galvanized Structural Steel Products and Procedure for Detecting Embrittlement
T 152	AASHTO			Air Content of Freshly Mixed Concrete by the Pressure Method
T 152	WAQTC	✓	✓	FOP for AASHTO T 152, Air Content of Freshly Mixed Concrete by the Pressure Method
T 153	AASHTO			Fineness of Hydraulic Cement by Air Permeability Apparatus
T 162	AASHTO			Mechanical Mixing of Hydraulic Cement Pastes and Mortars of Plastic Consistency
T 166	AASHTO			Bulk Specific Gravity ( $G_{mb}$ ) of Compacted Asphalt Mixtures Using Saturated Surface-Dry Specimens



Numerical Order				
Procedure Number	Owner	Field Use	In Manual	Test Method
T 166	WAQTC	✓	✓	FOP for AASHTO T 166, for Bulk Specific Gravity of Compacted Asphalt Mixtures Using Saturated Surface-Dry Specimens
T 176	AASHTO			Plastic Fines in Graded Aggregates and Soils by the Use of the Sand Equivalent Test
T 176	WAQTC	✓	✓	FOP for AASHTO T 176, Plastic Fines in Graded Aggregates and Soils by the Use of the Sand Equivalent Test
T 180	AASHTO			Moisture-Density Relations of Soils Using a 4.54 kg (10 lb) Rammer and a 457 mm (18 in.) Drop
T 180	WAQTC	✓	✓	FOP for AASHTO T 180, Moisture-Density Relations of Soils Using a 4.54 kg (10 lb) Rammer and a 457 mm (18 in.) Drop
T 192	AASHTO			Fineness of Hydraulic Cement by the 45- $\mu$ m (No. 325) Sieve
T 196	AASHTO		✓	Air Content of Freshly Mixed Concrete by the (Volumetric Method) (Checklist Only)
T 197	AASHTO			Time of Setting of Concrete Mixtures by Penetration Resistance
T 198	AASHTO			Splitting Tensile Strength of Cylindrical Concrete Specimens
M 201	AASHTO			Mixing Rooms, Moist Cabinets, Moist Rooms, and Water Storage Tanks Used in the Testing of Hydraulic Cements and Concretes
T 208	AASHTO			Unconfined Compressive Strength of Cohesive Soil
T 209	AASHTO			Theoretical Maximum Specific Gravity ( $G_{mm}$ ) and Density of Asphalt Mixtures
T 209	WAQTC	✓	✓	FOP for AASHTO T 209, Theoretical Maximum Specific Gravity ( $G_{mm}$ ) and Density of Asphalt Mixtures
T 215	AASHTO			Permeability of Granular Soils (Constant Head)
T 216	AASHTO			One-Dimensional Consolidation Properties of Soils
T 228	AASHTO			Specific Gravity of Semi-Solid Asphalt Materials
T 231	AASHTO			Capping Cylindrical Concrete Specimens
T 231	WSDOT	✓	✓	FOP for AASHTO T 231, Capping Cylindrical Concrete Specimens
T 236	AASHTO			Direct Shear test of Soils Under Consolidated Drained Conditions
T 240	AASHTO			Effect of Heat and Air on a Moving Film of Asphalt Binder (Rolling Thin-Film Oven Test)
T 242	AASHTO			Frictional Properties of Paved Surfaces Using a Full-Scale Tire
T 244	AASHTO			Mechanical Testing of Steel Products
M 251	AASHTO			Plain and Laminated Elastomeric Bridge Bearings
T 255	AASHTO			Total Evaporable Moisture Content of Aggregate by Drying
T 255	WAQTC	✓	✓	FOP for AASHTO T 255, Total Evaporable Moisture Content of Aggregate by Drying
T 260	AASHTO			Sampling and Testing for Chloride Ion in Concrete and Concrete Raw Materials
T 265	AASHTO			Laboratory Determination of Moisture Content of Soils
T 265	WAQTC	✓	✓	FOP for AASHTO T 265, Laboratory Determination of Moisture Content of Soils
T 267	AASHTO			Determination of Organic Content in Soils by Loss on Ignition
T 269	AASHTO			Percent Air Void in Compacted Dense and Open Asphalt Mixtures
T 272	AASHTO			One-Point Method for Determining Maximum Dry Density and Optimum Moisture
T 272	WAQTC	✓	✓	FOP for AASHTO T 272, One-Point Method for Determining Maximum Dry Density and Optimum Moisture
T 277	AASHTO			Electrical Indication of Concrete's Ability to Resist Chloride Ion Penetration
T 285	AASHTO			Bend Test for Bars for Concrete Reinforcement

Numerical Order				
Procedure Number	Owner	Field Use	In Manual	Test Method
T 288	AASHTO		✓	Determining Minimum Laboratory Soil Resistivity (Checklist Only)
T 289	AASHTO			Determining pH of Soil for Use in Corrosion Testing
E 290	ASTM			Standard Test Methods for Bend Testing of Material for Ductility
T 296	AASHTO			Unconsolidated, Undrained Compressive Strength of Cohesive Soils in Triaxial Compression
T 297	AASHTO			Consolidated, Undrained Triaxial Compressive Test on Cohesive Soils Shear
T 301	AASHTO			Elastic Recovery Test of Asphalt Materials by Means of a Ductilometer
T 303	AASHTO			Accelerated Detection of Potentially Deleterious Expansion of Mortar Bars Due to Alkali-Silica Reaction
T 304	AASHTO			Uncompacted Void Content of Fine Aggregate
T 304	WAQTC	✓	✓	FOP for AASHTO T 304, Uncompacted Void Content of Fine Aggregate
T 308	AASHTO			Determining the Asphalt Binder Content of Asphalt Mixtures by the Ignition Method
T 308	WAQTC	✓	✓	FOP for AASHTO T 308, Determining the Asphalt Binder Content of Asphalt Mixtures by the Ignition Method
T 309	AASHTO			Temperature of Freshly Mixed Hydraulic Cement Concrete
T 309	WAQTC	✓	✓	FOP for AASHTO T309, Temperature of Freshly Mixed Portland Cement Concrete
T 310	AASHTO			In-Place Density and Moisture Content of Soil and Soil-Aggregate by Nuclear Methods (Shallow Depth)
T 310	WAQTC	✓	✓	FOP for AASHTO T 310, In-Place Density and Moisture Content of Soil and Soil-Aggregate by Nuclear Methods (Shallow Depth)
C 311	ASTM			Sampling and Testing Fly Ash or Natural Pozzolans for Use in Portland Cement Concrete
T 312	AASHTO			Preparing and Determining the Density of Asphalt Mixture Specimens by Means of the Superpave Gyrotory Compactor
T 312	WAQTC	✓	✓	FOP for AASHTO T 312, Preparing and Determining the Density of Asphalt Mixture Specimens by Means of the Superpave Gyrotory Compactor
T 313	AASHTO			Determining the Flexural Creep Stiffness of Asphalt Binder Using the Bending Beam Rheometer (BBR)
T 313	WSDOT		✓	Method of Test for Cement-Latex Compatibility
T 314	WSDOT		✓	Method of Test for Photovolt Reflectance
T 315	AASHTO			Determining the Rheological Properties of Asphalt Binder Using a Dynamic Shear Rheometer (DSR)
T 316	AASHTO			Viscosity Determination of Asphalt Binder Using Rotational Viscometer
SOP 318	WSDOT		✓	Standard Operating Procedure for Melting of Flexible Bituminous Pavement Marker Adhesive for Evaluation
T 324	AASHTO		✓	Hamburg Wheel-Track Testing of Compacted Asphalt Mixtures
T 329	AASHTO			Moisture Content of Asphalt Mixtures by Oven Method
T 329	WAQTC	✓	✓	FOP for AASHTO T 329, Moisture Content of Asphalt Mixture by Oven Method
T 331	AASHTO			Bulk Specific Gravity ( $G_{mb}$ ) and Density of Compacted Asphalt Mixtures Using Automatic Vacuum Sealing Method
T 331	WAQTC	✓	✓	FOP for AASHTO T 331, Bulk Specific Gravity ( $G_{mb}$ ) and Density of Compacted Asphalt Mixtures Using Automatic Vacuum Sealing Method
T 335	AASHTO			Determining the Percentage of Fracture in Coarse Aggregate
T 335	WAQTC	✓	✓	FOP for AASHTO T 335, Determining the Percentage of Fracture in Coarse Aggregate

Numerical Order				
Procedure Number	Owner	Field Use	In Manual	Test Method
T 350	AASHTO			Multiple Stress Creep Recovery (MSCR) Test of Asphalt Binder Using a Dynamic Shear Rheometer (DSR)
T 355	AASHTO			In-Place Density of Asphalt Mixtures by Nuclear Methods
T 355	WAQTC	✓	✓	FOP for AASHTO T 355, In-Place Density of Asphalt Mixtures by Nuclear Methods
T 359	AASHTO			Pavement Thickness by Magnetic Pulse Induction
A 370	ASTM			Definitions for Mechanical Testing of Steel Products
T 413	WSDOT	✓	✓	Method of Test for Evaluating Waterproofing Effectiveness of Membrane and Membrane-Pavement Systems
T 417	WSDOT		✓	Method of Test for Determining Minimum Resistivity and pH of Soil and Water
T 421	WSDOT		✓	Traffic Controller Inspection Procedure
T 422	WSDOT		✓	Transient Voltage Test (Spike Test) Procedure (optional)
T 423	WSDOT		✓	Conflict Monitor Test Procedure
T 424	WSDOT		✓	Power Interruption Test Procedure
T 425	WSDOT		✓	Environmental Chamber Test Procedure
T 426	WSDOT		✓	Pull-Off Test for Hot Melt Traffic Button Adhesive
T 427	WSDOT		✓	Loop Amplifier Test Procedure
T 428	WSDOT		✓	Traffic Controller Compliance Inspection and Test Procedure
SOP 429	WSDOT		✓	Methods for Determining the Acceptance of Traffic Signal Controller Assemblies
T 430	WSDOT		✓	Uninterruptible Power Supply (UPS) System Compliance Inspection and Test Procedure
T 432	WSDOT		✓	Flexibility Test for Hot-Melt Adhesives
C 457	ASTM			Microscopical Determination of Parameters of the Air-Void System in Hardened Concrete
C 495	ASTM			Compressive Strength of Lightweight Insulated Concrete
T 501	WSDOT		✓	Test Method to Determine Durability of Very Weak Rock
D 523	ASTM			Specular Gloss
C 579	ASTM			Compressive Strength of Chemical-Resistant Mortars, Grouts, Monolithic Surfacing, and Polymer Concretes
F 606	ASTM			Determining the Mechanical Properties of Externally and Internally Threaded Fasteners, Washers, Direct Tension Indicators, and Rivets
T 610	WSDOT		✓	Method of Test for the Capillary Rise of Soils
A 615	ASTM			Standard Specification for Deformed and Plain Carbon-Steel Bars for Concrete Reinforcement
SOP 615	WSDOT	✓	✓	Determination of the % Compaction for Embankment and Untreated Surfacing Materials Using the Nuclear Moisture-Density Gauge
D 638	ASTM			Tensile Properties of Plastics
D 695	ASTM			Compressive Properties of Rigid Plastics
T 716	WSDOT	✓	✓	Method of Random Sampling for Locations of Testing and Sampling Sites
T 720	WSDOT		✓	Method of Test for Thickness Measurement of Hot Mix Asphalt (HMA) Cores
SOP 729	WSDOT	✓	✓	Standard Operating Procedure for Determination of the Moving Average of Theoretical Maximum Density (TMD) for HMA
SOP 730	WSDOT	✓	✓	Standard Operating Procedure for Correlation of Nuclear Gauge Densities With Hot Mix Asphalt (HMA) Cores
SOP 731	WSDOT	✓	✓	Standard Operating Procedure for Determining Volumetric Properties of Hot Mix Asphalt

Numerical Order				
Procedure Number	Owner	Field Use	In Manual	Test Method
SOP 732	WSDOT	✓	✓	Standard Operating Procedure for Volumetric Design for Hot-Mix Asphalt (HMA)
SOP 733	WSDOT	✓	✓	Standard Operating Procedure for Determination of Pavement Density Differentials Using the Nuclear Density Gauge
SOP 734	WSDOT	✓	✓	Standard Operating Procedure for Sampling Hot Mix Asphalt After Compaction (Obtaining Cores)
SOP 735	WSDOT	✓	✓	Standard Operating Procedure for Longitudinal Joint Density
SOP 736	WSDOT		✓	In-Place Density of Bituminous Mixes Using Cores
SOP 737	WSDOT		✓	Procedure for the Forensic Testing of HMA Field Cores
SOP 738	WSDOT	✓	✓	Establishing Maximum Field Density for Recycled Concrete Aggregates by Test Point Evaluation
D 792	ASTM			Density and Specific Gravity (Relative Density) of Plastics by Displacement
T 802	WSDOT	✓	✓	Method of Test for Flexural Strength of Concrete (Using Simple Beam With Center-Point Loading)
C 805	ASTM			Rebound Number of Hardened Concrete
C 805	WSDOT	✓	✓	Rebound Hammer Determination of Compressive Strength of Hardened Concrete
T 807	WSDOT	✓	✓	Method of Operation of California Profilograph and Evaluation of Profiles
T 808	WSDOT	✓	✓	Method for Making Flexural Test Beams
T 813	WSDOT	✓	✓	Field Method of Fabrication of 2 in (50 mm) Cube Specimens for Compressive Strength Testing of Grouts and Mortars
T 814	WSDOT		✓	Method of Test for Water Retention Efficiency of Liquid Membrane-Forming Compounds and Impermeable Sheet Materials for Curing Concrete
T 818	WSDOT		✓	Air Content of Freshly Mixed Self-Compacting Concrete by the Pressure Method
T 819	WSDOT		✓	Making and Curing Self-Compacting Concrete Test Specimens in the Field
D 823	ASTM			Producing Films of Uniform Thickness of Paint, Coatings and Related Products on Test Panels
C 881	ASTM			Standard Specification for Epoxy-Resin-Base Bonding Systems for Concrete
C 882	ASTM		✓	Bond Strength of Epoxy-Resin Systems Used With Concrete By Slant Shear (Checklist Only)
SOP 914	WSDOT	✓	✓	Practice for Sampling of Geosynthetic Material for Testing
T 915	WSDOT		✓	Practice for Conditioning of Geotextiles for Testing
T 923	WSDOT		✓	Thickness Measurement of Geotextiles
T 925	WSDOT		✓	Standard Practice for Determination of Long-Term Strength for Geosynthetic Reinforcement
T 926	WSDOT		✓	Geogrid Brittleness Test
C 939	ASTM			Flow of Grout for Preplaced-Aggregate Concrete (Flow Cone Method)
C 939	WSDOT	✓	✓	FOP for ASTM for Flow of Grout for Preplaced-Aggregate Concrete (Flow Cone Method)
D 1140	ASTM			Determining the Amount of Material Finer than 75- $\mu$ m (No. 200) Sieve in Soils by Washing
1188	IEEE			Standards Publication: Recommended Practice for Maintenance, Testing, and Replacement of Valve-Regulated Lead-Acid (VRLA) batteries for Stationary Applications

Numerical Order				
Procedure Number	Owner	Field Use	In Manual	Test Method
C 1218	ASTM			Water-Soluble Chloride in Mortar and Concrete
C 1231	ASTM			Use of Unbonded Caps in Determination of Compressive Strength of Hardened Cylindrical Concrete Specimens
C 1231	WSDOT	✓	✓	FOP for ASTM C1231, Use of Unbonded Caps in Determination of Compressive Strength of Hardened Cylindrical Concrete Specimens
C 1437	ASTM			Standard Test Method for Flow of Hydraulic Cement Mortar
D 1475	ASTM			Density of Liquid Coatings, Inks, and Related Products
C 1604	ASTM			Obtaining and Testing Drilled Cores of Shotcrete
C 1611	WSDOT	✓	✓	FOP for ASTM C 1611/C 1611M Standard Test Method for Slump Flow of Self-Consolidating Concrete
C 1621	WSDOT	✓	✓	FOP for ASTM C 1621/C 1621M Standard Test Method for Passing Ability of Self-Consolidating Concrete by J-Ring
D 1683	ASTM			Failure in Sewn Seams of Woven Fabrics
D 1751	ASTM			Preformed Expansion Joint Filler for Concrete Paving and Structural Construction (Nonextruding and Resilient Bituminous Types)
D 2240	ASTM			Standard Test Method for Rubber Property – Durometer Hardness
D 2244	ASTM			Standard Practice for Calculation of Color Tolerances and Color Differences From Instrumentally Measured Color Coordinates
D 2369	ASTM			Volatile Content of Coatings
D 2487	ASTM			Standard Practice for Classification of Soils for Engineering Purposes (Unified Soil Classification System)
D 2488	ASTM			Standard Practice for Description and Identification of Soils (Visual-Manual Procedure)
D 2621	ASTM			Infrared Identification of Vehicle Solids From Solvent-Reducible Paints
D 2628/ M 220	ASTM	✓	✓	Preformed Polychloroprene Elastomeric Joint Seals for Concrete Pavements
D 2697	ASTM			Volume Nonvolatile Matter in Clear or Pigmented Coatings
D 2698	ASTM			Determination of the Pigment Content of Solvent-Reducible Paints by High-Speed Centrifuging
D 3111	ASTM			Flexibility Determination of Hot-Melt Adhesives by Mandrel Bend Test Method
D 3723	ASTM			Pigment Content of Water Emulsion Paints by Temperature Ashing
D 4186	ASTM			One-Dimensional Consolidation Properties of Saturated Cohesive Soils Using Controlled-Strain Loading
D 4354	ASTM		✓	Standard Practice for Sampling of Geosynthetics and Rolled Erosion Control Products (RECPs) for Testing
D 4355	ASTM			Deterioration of Geotextiles From Exposure to Light, Moisture and Heat in a Xenon-Arc-Type Apparatus
D 4491	ASTM			Water Permeability of Geotextiles by Permittivity
D 4533	ASTM			Trapezoid Tearing Strength of Geotextiles
D 4543	ASTM			Preparing Rock Core as Cylindrical Test Specimens and Verifying Conformance to Dimensional and Shape Tolerances
D 4595	ASTM			Tensile Properties of Geotextiles by the Wide-Width Strip Method
D 4632	ASTM			Grab Breaking Load and Elongation of Geotextiles
D 4644	ASTM			Slake Durability of Shales and Similar Weak Rocks
D 4694	ASTM			Deflections with Falling-Weight-Type Impulse Load Device
D 4751	ASTM			Determining Apparent Opening Size of a Geotextile
D 4767	ASTM			Standard Test Method for Consolidated Undrained Triaxial Compression Test for Cohesive Soils

Numerical Order				
Procedure Number	Owner	Field Use	In Manual	Test Method
D 5084	ASTM			Measurement of Hydraulic Conductivity of Saturated Porous Materials Using a Flexible Wall Permeameter
D 5167	ASTM			Melting of Hot-Applied Joint and Crack Sealant and Filler for Evaluation
ATC 5301	AASHTO ITE NEMA			Publication: Advanced Transportation Controller (ATC) Cabinet Standard
D 5311	ASTM			Load Controlled Cyclic Triaxial Strength of Soil
D 5329	ASTM			Sealants and Fillers, Hot-Applied, for Joints and Cracks in Asphalt Pavements and Portland Cement Concrete Pavements
D 5731	ASTM			Determination of the Point Load Strength Index of Rock and Application to Rock Strength Classifications
D 6241	ASTM			Static Puncture Strength of Geotextiles and Geotextile-Related Products Using a 50-mm Probe
D 6467	ASTM			Torsional Ring Shear Test to Determine Drained Residual Shear Strength of Cohesive Soils
D 6528	ASTM			Consolidated Undrained Direct Simple Shear Testing of Cohesive Soils
D 6690	ASTM			Joint and Crack Sealants, Hot Applied, for Concrete and Asphalt Pavements
D 6931	ASTM		✓	Indirect Tensile (IDT) Strength of Asphalt Mixtures
D 7012	ASTM		✓	Compressive Strength and Elastic Moduli of Intact Rock Core Specimens under Varying States of Stress and Temperatures
D 7091	ASTM		✓	Nondestructive Measurement of Dry Film Thickness of Nonmagnetic Coatings Applied to Ferrous Metals and Nonmagnetic, Nonconductive Coatings Applied to Non-Ferrous Metals (Checklist Only)
62040-3	IEC			Standards Publication: Uninterruptible Power Systems (UPS) – Method for specifying the performance and test requirements

## **WSDOT Standard Practice QC 1**

### ***Standard Practice for Cement Producers/Suppliers That Certify Portland Cement and Blended Hydraulic Cement***

#### **1. Scope**

This standard specifies requirements for all producers/suppliers of portland cement and/or blended hydraulic cement.

This standard may involve hazardous materials, operations and equipment. It does not address all of the safety problems associated with their use. It is the responsibility of those using this standard to consult and establish appropriate safety and health practices and determine the applicability of regulatory limitations prior to use.

#### **2. Referenced Documents**

##### **2.1 AASHTO Standards**

M 85	Standard Specification for Portland Cement
M 240	Standard Specification for Blended Hydraulic Cement
R 18	Establishing and Implementing a Quality Management System for Construction Materials Testing Laboratories
T 127	Standard Method of Test for Sampling and Amount of Testing of Hydraulic Cement

##### **2.2 ASTM Standards**

C150	Standard Specification for Portland Cement
C595	Standard Specification for Blended Hydraulic Cement

##### **2.3 WSDOT Standards and Documents**

Current WSDOT <i>Standard Specifications</i>	M 41-10
Current WSDOT Qualified Products List	

### 3. Terminology

- 3.1 AASHTO – American Association of State Highway and Transportation Officials
- 3.2 ASTM – American Society of Testing and Materials
- 3.3 CCRL – Cement and Concrete Reference Laboratory
- 3.4 WSDOT – Washington State Department of Transportation: the agency responsible for the final acceptance of portland cement and/or blended hydraulic cement.
- 3.5 QPL – Qualified Products List
- 3.6 Producer – A production facility that has the capacity for producing and/or grinding portland cement and/or blended hydraulic cement meeting the requirements of the *Standard Specifications* Section 9-01.
- 3.7 Supplier – A company that supplies portland cement and/or blended hydraulic cement that meets the requirements of *Standard Specifications* Section 9-01.
- 3.8 Quality Management Plan – The producer/supplier plan to ensure that the portland cement and/or blended hydraulic cement meets the specification requirements through a systematic program of sampling, testing, and inspection.
- 3.9 Specification Compliance Testing – Complete testing in accordance with the specification requirements for the material identified.
- 3.10 Quality Control Testing – Testing performed per the producer/supplier quality management plan to evaluate the production process.
- 3.11 CAP – Cement Acceptance Program
- 3.12 Manufacturer’s Certification (Mill Test Report) – A document provided by the producer/supplier showing the physical and chemical test results with specification limits for each property tested on the portland cement or blended hydraulic cement.
- 3.13 Portland Cement – Portland cement meeting the requirements of *Standard Specifications* Section 9-01.2(1).
- 3.14 Blended Hydraulic Cement – Blended hydraulic cement meeting the requirements of *Standard Specifications* Section 9-01.2(1)B.
- 3.15 No Production Report – A document provided to WSDOT when portland cement and/or blended hydraulic cement was not produced or shipped during a given month.

### 4. Significance and Use

This standard specifies procedures for accepting portland cement and blended hydraulic cement. This is accomplished by the cement acceptance program that evaluates quality control and specification compliance tests performed by the producers and suppliers according to their quality management plan. Products determined to meet the requirements of this standard are eligible for listing on the WSDOT Qualified Products List (QPL).



## 5. Laboratory and Tester Requirements

The producers/suppliers testing laboratory used to conduct specification compliance testing for the quality management program shall be an AASHTO accredited laboratory and shall maintain AASHTO accreditation while participating in the WSDOT CAP program. Only laboratories that are participants in the CCRL on-site inspection and proficiency sample program and are accredited from the AASHTO Accreditation Program (AAP) are recognized as approved laboratories for this program.

## 6. Qualification of Producers/Suppliers

- 6.1 Producers/Suppliers shall submit a written request to WSDOT for acceptance into CAP and provide the following:
- A copy of the producer/supplier quality management plan meeting the requirements of Section 7 of QC 1.
  - A copy of the producer/supplier testing laboratory's AASHTO accreditation. One representative 10 pound sample for each type of portland cement and/or blended hydraulic cement along with the corresponding mill test report. Samples shall be taken in accordance with AASHTO T 127.
  - A copy of the Safety Data Sheet (SDS) as applicable for each sample submitted.
  - Mill test reports from the previous three (3) months from the production facility.
- 6.2 WSDOT will evaluate the submittal and may test the samples provided in accordance with Section 9 of QC 1. WSDOT will notify prospective producers/suppliers in writing after completion of the evaluation. All determinations of approval or rejection by WSDOT shall be final.
- 6.3 The producer/supplier shall allow WSDOT to visit and observe the quality control activities and provide samples to WSDOT upon request.

## 7. Producers/Suppliers Quality Management Plan

- 7.1 The quality management plan as a minimum shall identify the following:
- Facility type.
  - Facility address.
  - Name, email address, and telephone number of the contact person responsible for the quality control of the facility.
  - List each quality control test method to be performed on each type of portland cement or blended hydraulic cement.
  - Name and address of the AAP testing laboratory performing specification compliance testing.
  - Declaration stating that if a test result indicates a lot of portland cement or blended hydraulic cement is not in compliance with the WSDOT specifications, the facility shall immediately notify WSDOT of the lot in question. A representative sample for the production period in question shall be sent to WSDOT for testing.

- Description of the method and frequency of sampling, quality control testing, and specification compliance testing.
  - Type of portland cement and/or blended hydraulic cement to be provided to WSDOT.
  - A statement of compliance with Section 5.
- 7.2 A new quality management plan shall be required whenever changes occur that cause the existing quality management plan to become inaccurate or invalid.

## 8. Documentation Requirements

8.1 Each producer/supplier shall certify conformance to *Standard Specifications* for physical and chemical requirements of AASHTO M 85, AASHTO M 240, ASTM C150, or ASTM C595 by means of a mill test report.

8.2 A mill test report shall be provided monthly by the cement producer to WSDOT on a continuous basis for AASHTO M 85, AASHTO M 240, ASTM C150, or ASTM C595 cement production.

Cement mill test reports shall be in English and include the following information:

- Name of producer
- Specific type of cement in accordance with *Standard Specifications* Section 9-01
- Unique identification number traceable to the date of production
- Production date

8.3 A mill test report shall be provided by the cement supplier to WSDOT whenever a new shipment of AASHTO M 85, AASHTO M 240, ASTM C150, or ASTM C595 imported cement is received for distribution.

Mill test reports shall be in English and include the following information:

- Name of supplier
- Specific type of cement in accordance with *Standard Specifications* Section 9-01
- Unique identification number traceable to each shipment
- Certification date

8.4 Separate sequences of mill test reports shall be provided for each individual production facility and a unique lot number traceable to a production run on cement shall identify each report.

8.5 The mill test report shall show the test results and the applicable specifications of AASHTO M 85, AASHTO M 240, ASTM C150 or ASTM C595 for each component or property tested and shall show the test requirements specified by WSDOT.

8.6 When a production facility does not produce cement in a given month, or no shipments are received by a supplier, the producer/supplier shall notify WSDOT with a no production report for each month of no production or shipment.

- 8.7 Mill test reports and no production reports shall be emailed to the CAP program at following email address: [caprogram@wsdot.wa.gov](mailto:caprogram@wsdot.wa.gov).
- 8.8 The producer/supplier shall notify WSDOT at the email address noted above of any temporary stops in production (greater than one month) or permanent stops in production.
- 8.9 All documentation shall be submitted to WSDOT within 28 days of the last day of the month of production or shipment.

## 9. Quarterly Split Sample

- 9.1 Cement producers/suppliers shall, on a quarterly basis, provide a split sample of each type of portland cement or blended hydraulic cement being produced.
- 9.2 For the purpose of this standard, quarters are defined as: January through March, April through June, July through September and October through December.
- 9.3 Split samples shall be taken from production or shipment in accordance with the producer/supplier's quality management plan.
- 9.4 The production sample shall be split into two portions (approximately 10 pounds each) for each type of cement being produced. One portion shall be retained by the producer/supplier and one portion shall be sent to WSDOT CAP.
- 9.5 The producer/supplier testing laboratory shall conduct chemical and physical testing on their portion.
- 9.6 The sample submitted to WSDOT shall be labeled with the type and lot number traceable to the production run or lot of cement. WSDOT may elect to test the sample.
- 9.7 Samples shall be sent to:
  - WSDOT State Materials Laboratory
  - ATTN: Cement Acceptance Program
  - 1655 S. Second Ave SW
  - Tumwater, WA 98512-6951
- 9.8 The quarterly split sample mill test report shall be emailed to the CAP program at the following email address: [caprogram@wsdot.wa.gov](mailto:caprogram@wsdot.wa.gov).
- 9.9 The producer/supplier shall email CAP at the email address noted in Section 9.8 if no cement was produced/shipped during that quarter and no sample will be submitted.
- 9.10 The quarterly split samples, and accompanying mill test report, shall be submitted to WSDOT within 28 days of the date of sampling.

## 10. Comparison of Quarterly Split Sample Test Results

- 10.1 Results of the split sample testing shall conform to the applicable AASHTO or ASTM specification requirements.
- 10.2 If any discrepancy is identified between the producer/suppliers and WSDOT's test results the producer/supplier shall prepare a response to WSDOT, within 30 days of being notified of discrepancy.
- 10.3 The response shall identify the cause of the discrepancy and describe any corrective action taken.

## 11. Revocation of Qualification

- 11.1 A producer/supplier may have its qualification status revoked and be removed from the QPL if found in nonconformance with the *Standard Specifications* or this standard practice. Causes for removal from the QPL may include, but are not limited to, the following:
  - Failure to comply with requirements of QC 1.
  - Failing test results on production or shipment samples.
  - Failure to notify WSDOT of changes in product formulation.
  - Failure to send in a retained sample for additional testing for a production period with failing test results.

Prior to removing a producer/supplier from the QPL, WSDOT will take appropriate measures to confirm the validity of the information and will confer with the producer/supplier.

## 12. Requalification

- 12.1 Once a product has been removed from the QPL, the producer/supplier may request reinstatement by providing the following written information to WSDOT:
  - The root cause and corrective action taken to prevent future reoccurrences of the problem that caused the removal from the QPL.
  - Updated quality management plan showing compliance with QC 1.
  - Other information and test data as determined by WSDOT.

Provided there is a satisfactory resolution of the initial problem, at WSDOT's discretion, the product may either be reinstated into the QPL or the producer/supplier may be required to reapply to the QPL. All costs of the QPL process shall be borne by the producer/supplier.



## WSDOT Standard Practice QC 2

### *Standard Practice for Asphalt Suppliers That Certify Performance Graded and Emulsified Asphalts*

#### 1. Scope

- 1.1 This standard specifies requirements and procedures for a certification system that shall be applicable to all suppliers of performance graded asphalt binder (PGAB) and emulsified asphalts. The requirements and procedures cover materials manufactured at refineries, materials mixed at terminals, in-line blended materials, and materials blended at the hot mix plant.
- 1.2 This standard may involve hazardous materials, operations and equipment. It does not address all of the safety problems associated with their use. It is the responsibility of whoever uses this standard to consult and establish appropriate safety and health practices and determine the applicability of regulatory limitations prior to use.

#### 2. Referenced Documents

##### 2.1 AASHTO Standards:

M 320 Specifications for Performance-Graded Asphalt Binder

R 29 Standard Practice for Grading or Verifying the Performance Grade of an Asphalt Binder

T 40 Method of Sampling Bituminous Materials

R 18 Establishing and Implementing a Quality System for Construction Materials Testing Laboratories

R 5 Selection and use of emulsified asphalts

T 59 Standard Method of Test for Emulsified Asphalts

##### 2.2 ASTM Standards

D 8 Definitions of Terms Relating to Materials for Roads and Pavements

D 3665 Random Sampling of Construction Materials

##### 2.3 WSDOT Standards and Documents

Current WSDOT *Standard Specifications*

Current WSDOT *Construction Manual*

Appropriate State Specifications

Current WSDOT Qualified Products List

### 3. Terminology

- 3.1 AAP – AASHTO Accreditation Program
- 3.2 Asphalt Binder – An asphalt-based cement that is produced from petroleum residue either with or without the addition of modifiers.
- 3.3 ASC – Approved Supplier Certification
- 3.4 Modification – Any manufacturing process which alters the properties of a single asphalt binder or emulsified asphalt for the purposes of meeting the requirements of a PGAB or emulsified asphalt.
- 3.5 PGAB – Performance Graded Asphalt Binder
- 3.6 Supplier – A supplier shall be defined as one who produces the final PGAB or emulsified asphalt product, or who makes, blends, modifies, or alters properties of the PGAB or emulsified asphalt. This process can occur at the refinery, terminal, the HMA Plant, or in a transport vehicle.

If no modifications are made to the PGAB or emulsified asphalt after its initial production at the refinery, the refinery shall be the supplier and must provide the certification. If material is purchased with the intent to resell with or without modification, the reseller shall then be considered the supplier.

If any modifications are made to the PGAB or emulsified asphalt at the terminal or in the transport vehicle, then the terminal or transporter shall be the supplier and must provide the certification.

If any modifications, blending or commingling of PGAB or emulsified asphalt from different sources is made at the HMA Plant or by the supplier of HMA or emulsified asphalt, then the supplier shall provide the certification for the PGAB or emulsified asphalt.

- 3.7 Agency – Agency shall be defined as a state highway agency or other agency responsible for the final acceptance of the PGAB.
- 3.8 Specification Compliance Testing – Complete testing in accordance with the specification requirements for the material identified.
- 3.9 Quality Control Testing – The quality control testing shall be described in the Supplier’s quality control plan. The Supplier’s quality control plan shall be approved by the Agency.
- 3.10 HMA- Hot Mix Asphalt
- 3.11 Emulsified asphalt-An emulsion of asphalt cement and water which contains a small amount of an emulsifying agent. Emulsified asphalt droplets may be of either the anionic or cationic type, depending upon the emulsifying agent.
- 3.12 QPL-Washington State Department of Transportation, Qualified Products List.

**Note 1:** Definitions for many terms common to asphalt binder are found in ASTM D8.

### 4. Significance and Use

- 4.1 This standard specifies procedures for minimizing the disruption of PGAB and emulsified asphalt shipments. This is accomplished by a certification system that evaluates quality control, on-site assessments, and specification compliance tests performed by the Supplier according to their quality control plan.

## 5. Sampling

- 5.1 All test samples required by this standard shall be obtained in accordance with AASHTO T 40. The use of a random sampling procedure similar to ASTM D3665 is important to the establishment of a valid certification program.

## 6. Laboratory and Tester Requirements

AASHTO accreditation in any test required by this standard is applicable. Laboratories which are not AASHTO accredited must meet the following requirements

- 6.1 Laboratory facilities shall adequately house and allow proper operation of all required equipment in accordance with the applicable test procedures.
- 6.2 The laboratory shall use personnel qualified in accordance with the appropriate sections of AASHTO R-18.
- 6.3 The laboratory shall use testing equipment that has been calibrated/standardized/checked to meet the requirements of each test procedure in accordance with the appropriate sections of AASHTO R-18.
- 6.4 Documentation of personnel qualifications and the equipment calibration/standardization/check records shall be maintained.
- 6.5 The Agency at their discretion may review the laboratory facility, testing equipment, personnel performing the testing, and review all qualification and calibration and verification testing.

## 7. Supplier Requirements

- 7.1 The Supplier shall submit a written request to the Agency for authorization to supply PGAB or emulsified asphalts. The request shall include copies of their preliminary test reports for the proposed PGAB or emulsified asphalts with the appropriate documentation. If requested by the Agency, a sample of the PGAB or emulsified asphalt shall be provided to the Agency for testing.

**Note:** Suppliers currently on the Qualified Products List shall be exempt from submitting a written request for those products they are already approved. WSDOT may request preliminary test reports and a sample for testing.

- 7.2 The Supplier shall allow the Agency to visit the production and/or shipping site to observe the Supplier's quality control activities, and to obtain samples for testing.
- 7.3 The Supplier shall submit to the Agency for approval a complete quality control plan that complies with the requirements of Section 8.
- 7.4 The Supplier shall follow the procedures described in the approved quality control plan.
- 7.5 A new Quality Control Plan shall be required whenever changes occur that cause the existing Quality Control Plan to become inaccurate or invalid.
- 7.6 The Supplier shall establish a continuing test record for each test required on each PGAB or emulsified asphalts.

## 8. Supplier Quality Control Plan (Minimum Requirements)

- 8.1 The Supplier's quality control plan shall identify the following:
  - 8.1.1 Facility type (refinery, terminal, in-line blending or HMA plant).
  - 8.1.2 Facility location.
  - 8.1.3 Name and telephone number of the contact person responsible for the quality control of the PGAB or emulsified asphalt at the facility.
  - 8.1.4 Name the laboratory performing quality control tests on the PGAB or emulsified asphalt that is shipped.
- 8.2 The Supplier's quality control plan shall include a declaration stating that if a test result indicates that a shipment of PGAB or emulsified asphalt is not in compliance with the purchase specifications, the Supplier shall (1) immediately notify the Agency of the shipment in question, (2) identify the material type and grade, (3) cease shipment until the material meets specification compliance, (4) notify the Agency prior to resuming shipment.
- 8.3 The Supplier's quality control plan shall describe the method and frequency for, sampling, specification compliance testing and quality control testing.
  - 8.3.1 Specification Compliance Testing shall be performed on an adequate amount of material to ensure specification compliance. The amount of material shall be agreed upon by the supplier and the Agency and included in the Quality Control Plan.

**Note:** Due to the various operations and manufacturing processes, each supplier will be treated individually.
  - 8.3.2 With the exception of the 24 Hour Storage Stability test, the Supplier of Emulsified Asphalt shall provide test results for each production batch of CRS-2P showing the product meets WSDOT *Standard Specification* 9-02.1(6)A upon or prior of delivery to the project. The 24 Hour Storage Stability test results shall be provided to the State Materials Laboratory in Tumwater within 48 hours of completion of the production batch.
  - 8.3.3 Quality Control Testing as identified in the quality control plan can be specification compliance testing or non-specification compliance testing. The quality control testing does not preclude the need to meet the Agency specifications.
- 8.4 The Supplier's quality control plan shall include a statement that the Supplier will prepare reports for all quality control and specification compliance tests performed during a given period and submit them to the Agency upon request.
- 8.5 The Supplier's Quality Control Plan shall include a procedure, which must be followed, for checking transport vehicles before loading to prevent contamination of shipments.



## 9. Agency Requirements

- 9.1 The Agency shall review the Supplier's Quality Control Plan and respond to the supplier within 30 days.
- 9.2 The Agency may perform quality assurance, acceptance sampling, or verification sampling and testing in accordance with the Agency standards.

## 10. Requirements For Shipping PGAB or Emulsified Asphalt By An Approved Supplier

- 10.1 The Supplier's Quality Control Plan as approved by the Agency (see Section 9) shall be implemented.
- 10.2 Each shipment shall be accompanied by two copies of the bill of lading, which shall include (1) the name and location of the Supplier, (2) the type and grade of material, (3) the quantity of material shipped, (4) the date of shipment, (5) a statement certifying the material meets specification requirements (6) a statement certifying that the transport vehicle was inspected before loading and was found acceptable for the material shipped, and (7) shipments of CRS-2P shall include test results per section 8.3.2.

## 11. Split Sample Testing

- 11.1 The Agency or the Supplier may request split sample testing. The test results will be provided immediately to both parties.
- 11.2 If the split sample test data is not within the precision specified for that particular test, a review of both sampling and testing procedures will be conducted by both the Supplier and the Agency.

## 12. Decertification

- 12.1 A Supplier may have its authorization to certify and supply a specific PGAB or emulsified asphalt revoked by the Agency if it is found not to conform to the specifications and standards as established under this standard. This will include being removed from the *Qualified Products List (QPL)*
- 12.2 The following criteria shall be used to judge the conditions of non-conformance:
  - 12.2.1 Failure to control the quality of the PGAB or emulsified asphalt by failing to follow the procedures described in the Supplier's approved Quality Control Plan as required under Section 8.4.
  - 12.2.2 Failure to cease shipment of PGAB or emulsified asphalt as required under Section 9.2 when a test result indicates that the PGAB or emulsified asphalt is not in compliance with the Agency specifications.
- 12.3 A Supplier that has been decertified may seek reinstatement by demonstrating conformance to Agency certification criteria. Reinstatement will also include reapplication to the *Qualified Products List*.





## WSDOT Standard Practice QC 3

### *Quality System Laboratory Review*

#### 1. Scope

This standard specifies requirements and procedures for the review of WSDOT Region Materials Laboratories and for Private Laboratories by the Quality Systems Laboratory Review Team. The elements of the On-site and/or Remote laboratory review may include the following:

- Review of the testing facility.
- Review of the equipment calibration/standardization/check/maintenance records.
- Review of the testing technician's training/certification/qualification records.
- Review of the equipment used to perform test procedures.
- Review of the technician performing the test procedures.
- Review of the most current and accessible test procedures to be performed.
- Review of associated manuals, test reports and calculations.
- Review of the Quality Management System (QMS).
- Review of AASHTO re:source accreditation.

#### 2. Referenced Documents

##### 2.1 AASHTO Standards

- R 18      Establishing and Implementing a Quality Management System for Construction Materials Testing Laboratories
- R 25      Standard Practice for Technician Training and Certification Programs
- R 61      Establishing Requirements for Equipment Calibrations, Standardizations, and Checks

##### 2.2 WSDOT Standards

*Materials Manual* M 46-01

[Construction Manual](#) M 41-01

[Standard Specifications for Road, Bridge, and Municipal Construction](#) M 41-10

*WSDOT Request for Proposal Technical Requirements for the Project under review*

### 3. Terminology

- 3.1 **AASHTO** – American Association of State Highway and Transportation Officials
- 3.2 **ASTM** – American Society for Testing and Materials
- 3.3 **Calibration** – a process that, under specified conditions, establishes metrological traceability by determining: (1) the relation between the quantity values provided by measurement standards and the corresponding indications from a measuring instrument or system, and (2) the resulting measurement uncertainty (Note 1).
- Note 1:** This definition for calibration and the following definitions for check, standardization, traceability, uncertainty, and verification of calibration are based on the definitions in R 61.
- 3.4 **Check** – A specific type of inspection and/or measurement performed on equipment and materials to indicate compliance or otherwise with stated criteria.
- 3.5 **Standardization** – A process that determines (1) the correction to be applied to the result of a measuring instrument, measuring system, material measure, or reference material when its values are compared to the values realized by standards; or (2) the adjustment to be applied to a piece of equipment when its performance is compared with that of an accepted standard or process.
- 3.6 **Maintenance** – A regularly scheduled preventive measure taken to preserve the effective working condition of test equipment
- 3.7 **Measurement Standard** – The embodiment of the definition of a given quantity, with a stated value and measurement uncertainty, used as a reference.<sup>2</sup> This term is often called “reference standard.”
- 3.8 **Metrological Traceability** – The property of a result of a measurement whereby it can be related to stated references, usually national or international standards, through a documented, unbroken chain of calibrations, each contributing to the measurement uncertainty.
- 3.9 **Quality Management System (QMS)** – The organizational structure, staff responsibilities, policies, standard operating procedures, processes, and records that assist the laboratory in achieving its quality objectives.
- 3.10 **Uncertainty** – A parameter associated with the result of a measurement that defines the range of the values that could be attributed to the measured quantity.
- 3.11 **WSDOT** – Washington State Department of Transportation
- 3.12 **WAQTC** – Western Alliance for Quality Transportation Construction
- 3.13 **ACI** – American Concrete Institute
- 3.14 **WTTQP** – WSDOT Testing Technician Qualification Program

#### 4. Significance and Use

- 4.1 This standard specifies procedures for reviewing laboratories for the purpose of determining the capability of the facility and its personnel to perform the necessary acceptance testing for WSDOT.

#### 5. Laboratory Requirements

##### 5.1 Facility and Equipment

- 5.1.1 Laboratory facilities shall adequately house and allow proper operation of all required equipment in accordance with the applicable test procedures.
- 5.1.2 The temperature and humidity of the laboratory shall meet the requirements of all test procedures performed in the laboratory.
- 5.1.3 The testing areas shall be clean and free of clutter.
- 5.1.4 The laboratory shall use testing equipment that meets the requirements of each test procedure.
- 5.1.5 Testing equipment for private laboratories and the State Materials Laboratory shall be calibrated/standardized/checked/maintained in accordance with the test procedure, appropriate sections of AASHTO R 18 and AASHTO R 61. WSDOT region and field laboratories testing equipment shall be calibrated/standardized/checked/maintained in accordance with the test procedure and Section 9-5 of the [Construction Manual M 41-01](#).
- 5.1.6 Documentation of equipment calibration/standardization/check/maintenance shall be maintained and available on-site during laboratory review.
- 5.1.7 Safety equipment will be available and maintained in proper working order.

##### 5.2 Technician Training and Evaluation

- 5.2.1 The laboratory shall only use personnel certified or method qualified in accordance with the appropriate sections of AASHTO R 18 and Section 9-5 of the [Construction Manual M 41-01](#).
- 5.2.2 The laboratory shall maintain records of training for each technician.
- 5.2.3 Laboratory technicians performing tests for Aggregate, Asphalt, or Soils compaction on WSDOT projects shall be certified in WTTQP/WAQTC requisite modules.
- 5.2.4 Laboratory technicians performing tests not associated with any WTTQP module certification shall be method qualified as described in Section 9-5.4 of the [Construction Manual M 41-01](#).

5.2.5 A method qualification shall consist of a written and performance examination. The performance examination shall be evaluated using a checklist relating to the test procedure. The checklist and written exam shall be filed in the technician's training record.

**Note:** Private laboratories may use test procedure checklists from the WSDOT *Materials Manual M 46-01*, or may develop their own checklists similar to those found in the *Materials Manual*.

5.2.6 A method qualification can be for a maximum of five years or for private laboratories at a reduced frequency stated in the *Laboratory Quality Management System Manual (QMS)*.

5.2.7 An Independent Assurance (IA) evaluation will be performed a minimum of once per calendar year on all active testers.

### 5.3 Manuals and Records

5.3.1 Private laboratories shall have an up-to-date Laboratory Quality Management System Manual (QMS) on-site and meeting the requirements of AASHTO R 18.

5.3.2 All private laboratories QMS shall be available for use and understood by laboratory staff.

5.3.3 The laboratory shall maintain copies of standards as identified in the WSDOT *Materials Manual M 46-01* for the testing performed and shall ensure that the procedures are the most current and readily accessible to technicians performing the testing. Laboratory personnel shall also have access to the most current copy of the WSDOT *Construction Manual M 41-01*.

**Note:** If an earlier version of the *Materials Manual* or *Construction Manual* is required by contract, the laboratory shall maintain an unaltered version of the required manual.

5.3.5 The laboratory must ensure Safety Data Sheets (SDSs) are readily accessible to all staff for any hazardous substances or products.

5.3.6 Test records are required to contain sufficient information to permit verification of any test report (original observations, calculations, derived data, and identification of personnel involved in the sampling and testing).

5.3.7 Amendments to reports must be made in the manner stated in the QMS and meet the requirements of AASHTO R 18.

5.3.8 The laboratory shall define the process used to ensure testers are performing the correct testing procedure according to the clients' contractual requirements (i.e., AASHTO, ASTM, WAQTC, or WSDOT test procedure as required by the contract).

5.3.9 Test reports are required to contain the following information:

- Identification of the report and date issued.
- Description, identification, and condition of test sample.
- Identification of the standard test method used and notation of all known deviations from, additions to, or exclusions from the test method.
- Test results and other pertinent data required by the standard test method.
- Name and address of the testing laboratory.
- Name and address of the client or identification of the project.
- Date of receipt of the test sample.
- Date of test performance.
- Name of tester performing the test.
- Name of person accepting technical responsibility for test report.

## 6. Sampling

6.1 Test samples required for observation of test procedures shall be obtained by:

FOP for AASHTO R 90 – Sampling Aggregate Products

FOP for AASHTO R 97 – Sampling Asphalt Mixtures

FOP for AASHTO R 66 – Sampling Asphalt Materials

FOP for WAQTC TM 2 – Sampling Freshly Mixed Concrete

## 7. Sample Preparation Requirements

7.1 Prior to the performance portion of the laboratory review, for the testing being performed, samples are required to be prepared as shown in [Table 1](#).

Table 1 Sample Preparation Requirements

Test Procedure	Test	Required Preparation
<b>Aggregate Tests</b>		
FOP for AASHTO T 27/11	Sieve Analysis of Fine and Coarse Aggregates	Have appropriate amount of the original sample reduced and dried to a constant mass.  *OPTIONAL: Have additional sample washed, dried, and ready for sieving. Retain all weights in order to do calculations.
FOP for AASHTO R 76	Reducing Samples of Aggregates to Testing Size	Have a minimum of 30 lbs dry material.
AASHTO T 84	Specific Gravity and Absorption of Fine Aggregates	Have approximately 1000 g of fine aggregate.
FOP for AASHTO T 85	Specific Gravity and Absorption of Coarse Aggregates	Have coarse aggregate meeting the minimum mass of test sample.
FOP for AASHTO T 176	Plastic Fines in Graded Aggregates and Soils by the Use of the Sand Equivalent Test	Have appropriate amount of #4 minus material prepared for the moisture conditioning process (do not moisten).  OPTIONAL: Have 2 additional prepared tins ready for introduction into the SE tube.
FOP for AASHTO T 255	Total Evaporable Moisture Content of Aggregate by Drying	Have a representative sample meeting the minimum sample mass.
FOP for AASHTO T 304	Uncompacted Void Content of Fine Aggregate	Have an appropriate size standard graded sample.  *OPTIONAL: Have additional sample weighed out and combined to the quantities identified in Table 1.
FOP for AASHTO T 335	Determining the Percentage of Fracture in Coarse Aggregate	Have a sample dried, sieved and reduced to appropriate test size for combined fracture determination.



**Table 1 Sample Preparation Requirements**

Test Procedure	Test	Required Preparation
<b>Concrete Tests</b>		
WSDOT FOP for AASHTO T 22	Compressive Strength of Cylindrical Concrete Specimens	Have 2 cylindrical concrete specimens.
WSDOT FOP for AASHTO T 106	Compressive Strength of Hydraulic Cement Mortar	Have 3 hydraulic cement mortar cube specimens.
AASHTO T 231	Capping Cylindrical Concrete Specimens	Have capping sulfur mortar heated to appropriate temperature and ready for capping (can use cylinders for T 22).
ASTM C1231	Use of Unbonded Caps in Determination of Compressive Strength of Hardened Cylindrical Concrete Specimens	Demonstrate if applicable (can use cylinders for T 22).
<b>Soils Tests</b>		
FOP for AASHTO T 89	Determining the Liquid Limit of Soils	Have sample prepared to perform Method "B".
FOP for AASHTO T 90	Determining the Plastic Limit and Plasticity Index of Soils	Have sample prepared per the "Sample" section.
FOP for AASHTO T 99/T 180	Moisture-Density Relations of Soils	Prepare five representative samples of #4 or ¾" material at approximately 2 percent moisture already added to each sample starting at approximately 4 percent below optimum moisture of the material. Store in sealed containers.
AASHTO T 100	Specific Gravity of Soils	Have sample prepared in accordance to step 9. of AASHTO procedure.
FOP for AASHTO T 265	Laboratory Determination of Moisture Content of Soils	Have a representative sample meeting the minimum sample mass.
WSDOT Test Method T 417	Method of Test for Determining Minimum Resistivity and pH of Soil and Water	Have 100 g sample of natural #8 minus material for the pH test. Prepare the soil/ water slurry a minimum of 1 hr prior to test review.  Have a sample of # 8 minus material that is four times the volume of the soil box for the Resistivity test. Add 10% by weight of water to the sample and allow it to stand a minimum of 12 hrs in a waterproof container.
WAQTC TM 15	Method of Test for Compaction Control of Granular Materials	Have samples prepared in accordance to steps 7 and 8. of TM 15.

Table 1 Sample Preparation Requirements

Test Procedure	Test	Required Preparation
<b>Asphalt Mixture Tests</b>		
FOP for AASHTO T 30	Mechanical Analysis of Extracted Aggregate	Use sample from T 308. *OPTIONAL: Have additional sample washed, dried, and ready for sieving. Retain all weights in order to do calculations.
FOP for AASHTO R 47	Reducing Samples of Asphalt Mixtures to Testing Size	Have adequate amount of asphalt mixture to perform the following required testing; T 308, T 312, T 329, T 209 (approximately 30 lbs of mix is usually adequate). Have sample warm enough to separate.
FOP for AASHTO T 166	Bulk Specific Gravity ( $G_{mb}$ ) of Compacted Asphalt Mixtures Using Saturated Surface-Dry Specimens	Use sample from T 312. *OPTIONAL: Have a room temperature compacted specimen or core sample ready.
FOP for AASHTO T 209	Theoretical Maximum Specific Gravity ( $G_{mm}$ ) and Density of Asphalt Mixtures	Use reduced sample from R 47. *OPTIONAL: Have additional sample with particles separated and cooled to room temperature.
FOP for AASHTO T 308	Determining the Asphalt Binder Content of Asphalt Mixtures by the Ignition Method	Use reduced sample from R 47.
FOP for AASHTO T 312	Preparing and Determining the Density of Asphalt Mixture Specimens by Means of the Superpave Gyrotory Compactor	Use reduced sample from R 47. *OPTIONAL: Have additional sample heating at compaction temperature.
FOP for AASHTO T 329	Moisture Content of Asphalt Mixtures by Oven Method	Use reduced sample from R 47.
FOP for AASHTO T 331	Bulk Specific Gravity ( $G_{mb}$ ) and Density of Compacted Asphalt Mixtures Using Automatic Vacuum Sealing Method	Use sample from T 312. *OPTIONAL: Have a room temperature compacted specimen or core sample ready.

**Table 1 Sample Preparation Requirements**

Test Procedure	Test	Required Preparation
WSDOT Test Method T 720	Method of Test for Thickness Measurement for Asphalt Mixture Cores	Asphalt Mixture core obtained from WSDOT SOP 734.
WAQTC TM 14	Laboratory Prepared Asphalt Mixture Specimens	<p>Representative aggregate from stockpiles used in JMF, dried to a constant mass.</p> <p>Aggregate samples prepared and heated to mixing temperature as recommended by binder supplier.</p> <p>Binder used in JMF mix design heated to mixing temperature as recommended by binder supplier (typically one quart container).</p>
WSDOT SOP 730	Correlation of Nuclear Gauge Densities with Asphalt Mixture Cores	Verbal demonstration and completed worksheet/report reflecting calculated gauge correlation factor.
* <b>OPTIONAL</b> preparation may require verbal steps.		

## 8. Performance of Test Procedure

- 8.1 All technicians must be current in their WTTQP/WAQTC/ACI certifications or method qualifications.
- 8.2 The laboratory review team will evaluate the technician's testing proficiency using an approved WSDOT checklist.

**Note:** If certification or qualification is current and an IA audit has been performed in the last 12 months, this requirement may be considered satisfied and no further action is needed.

- 8.3 All equipment, used during the evaluation of the technician's proficiency, must be operational and have a current calibration sticker on the equipment.
- 8.4 When the test is complete, the reviewer will go over the checklist with the tester and point out any deficiencies that occurred during the performance of the test procedure.

## 9. Termination of Review

- 9.1 A laboratory review team member may choose to terminate the review of a procedure for the following reasons:
  - 9.1.1 Equipment is non-operational or the wrong equipment is being used.
  - 9.1.2 Tester is not qualified in the test procedure being reviewed.
  - 9.1.3 Tester makes multiple major errors in the performance of the test.
- 9.2 The review of the laboratory may be terminated by the WSDOT Quality Systems Manager for the following reasons:
  - 9.2.1 Facility is not adequate for the test procedures being reviewed.
  - 9.2.2 Two or more testers fail during the proficiency portion of the review.
  - 9.2.3 Documentation of qualification of testers or calibration of equipment is not available for review when team arrives.

## 10. Failure of Review

- 10.1 Rescheduling a review will require the following wait periods:
  - First Failure – Minimum of one week wait to reschedule.
  - Second Failure – Minimum of one month wait to reschedule.
  - Third Failure – Minimum of one month wait and submittal of corrective action documentation. The documents submitted must state the concerns of the review team and the corrective action taken to solve the problem.

## 11. Laboratory Review Team Report

- 11.1 The Laboratory Review Team will review the facility, equipment, records, and testers compliance with the established requirements.
- 11.2 During the review, members of the team may:
  - 11.2.1 Have observations or recommendations for improvements to the performance of the test procedure or operation of test equipment. These will be noted on the final letter of qualification but does not require a response unless repeated in consecutive reviews.
  - 11.2.2 Have findings that can be addressed and resolved at the time of the on-site review.
  - 11.2.3 Have findings that require a written corrective action response.
  - 11.2.4 Have repeat findings that require a detailed written corrective action response that includes a root cause analysis.

## 12. Approval of Laboratory

- 12.1 A preliminary email will be prepared and sent to the laboratory within 30 days of the completion of the review.
    - 12.1.1 The preliminary email will only address "Findings" labeled "Corrective Action Required".
    - 12.1.2 The required corrective action must include a detailed explanation stating how the laboratory has resolved the finding and what measures have been taken to prevent this finding from reoccurring in the future. Substantiating evidence may be required along with detailed explanations in some circumstances.
    - 12.1.3 Once the preliminary email has been received, the laboratory will have 30 days to respond to all "Findings" labeled "Corrective Action Required."
  - 12.2 Once all corrective actions are received and accepted or if the laboratory had no findings requiring a response, a final letter of qualification will be issued. The final letter will address the following:
    - 12.2.1 All the elements of the on-site or remote review
    - 12.2.2 Results of review including all findings, observations and recommendations.
    - 12.2.3 Approved test procedures.
    - 12.2.4 Qualification Approval dates.
- Note:** For private laboratories, approval is only good for WSDOT projects identified on final letter of qualification.

- 12.3 If the laboratory review contained corrective action required findings, the laboratory may receive a conditional approval until the deficiencies are corrected or the review team may recommend that the laboratory be disapproved for all testing until the deficiencies are corrected to the satisfaction of the WSDOT Quality System Manager.
- 12.4 A Laboratory that presents a current AASHTO re:source Accreditation certificate specific to the project testing requirements; may be allowed to perform acceptance testing for up to two years with a satisfactory initial review by the Laboratory Review Team concurred with by the Asst. State Materials Engineer.



## WSDOT Standard Practice QC 4

### *Standard Practice for Fly Ash and Natural Pozzolan Producers/Importers/Distributors That Certify Fly Ash and Natural Pozzolan*

#### 1. Scope

This standard specifies requirements for all producers/importers/distributors of fly ash and natural pozzolan.

This standard may involve hazardous materials, operations and equipment. It does not address all of the safety problems associated with their use. It is the responsibility of those using this standard to consult and establish appropriate safety and health practices and determine the applicability of regulatory limitations prior to use.

#### 2. Referenced Documents

##### 2.1. AASHTO Standards

M 295 Standard Specification for Coal Ash and Raw or Calcined Natural Pozzolan for Use in Concrete

R 18 Establishing and Implementing a Quality Management System for Construction Materials Testing Laboratories

##### 2.2. ASTM Standards

C618 Standard Specification for Coal Ash and Raw or Calcined Natural Pozzolan for Use in Concrete

C311 Standard Test Methods for Sampling and Testing Coal Ash or Natural Pozzolans for Use in Concrete

##### 2.3. WSDOT Standards and Documents

Current WSDOT [Standard Specifications](#) M 41-10

Current WSDOT Qualified Products List

#### 3. Terminology

3.1. AASHTO – American Association of State Highway and Transportation Officials

3.2. ASTM – American Society of Testing and Materials

3.3. CCRL – Cement and Concrete Reference Laboratory

3.4. WSDOT – Washington State Department of Transportation: the agency responsible for the final acceptance of fly ash and natural pozzolan.

3.5. QPL – Qualified Products List

- 3.6. Production Facility – A facility that has the capacity for producing fly ash or natural pozzolan that meets the requirements of the *Standard Specifications* Section 9-23.9 for fly ash or 9-23.12 for natural pozzolan.
- 3.7. Import/Distribution Facility – A facility that receives fly ash or natural pozzolan products for distribution that meets the requirements of the *Standard Specifications* Section 9-23.9 for fly ash or 9-23.12 for natural pozzolan.
- 3.8. Supplier – A supplier stores and then delivers fly ash or natural pozzolan produced by another entity to a concrete plant or another supplier.
- 3.9. Supplier Certification – Certification of the fly ash or natural pozzolan provided by the supplier or importer using representative test results obtained in accordance with a WSDOT approved QMP and approved testing lab.
- 3.10. Quality Management Plan – The producer/importer/distributor plan to ensure that the fly ash or natural pozzolan meets the specification requirements through a systematic program of sampling, testing, and inspection.
- 3.11. Specification Compliance Testing – Complete testing in accordance with the specification requirements for the material identified.
- 3.12. Quality Control Testing – Testing performed per the producer/importer/distributor quality management plan to evaluate the production process.
- 3.13. CAP – Cement Acceptance Program
- 3.14. Manufacturer’s Certification (Mill Test Report) – A document provided by the producer/importer/distributor showing the physical and chemical test results with specification limits for each property tested on the fly ash or natural pozzolan.
- 3.15. Fly Ash – Fly ash meeting the requirements of *Standard Specifications* Section 9-23.9.
- 3.16. Natural Pozzolan – Natural pozzolan meeting the requirements of *Standard Specifications* Section 9-23.12.
- 3.17. No Production Report – A document provided to WSDOT when fly ash or natural pozzolan was not produced or shipped during a given month.

#### 4. Significance and Use

- 4.1. This standard specifies procedures for accepting fly ash and natural pozzolan. This is accomplished by the cement acceptance program that evaluates quality control and specification compliance tests performed by the production/import/distribution facility according to their quality management plan. Products determined to meet the requirements of this standard are eligible for listing on the WSDOT Qualified Products List (QPL).

#### 5. Laboratory and Tester Requirements

The producers/importers/distributors testing laboratory used to conduct specification compliance testing for the quality management program shall be an AASHTO accredited laboratory and shall maintain AASHTO accreditation while participating in the WSDOT CAP program. Only laboratories that are participants in the CCRL on-site inspection and proficiency sample program and are accredited from the AASHTO Accreditation Program (AAP) are recognized as approved laboratories for this program.



## 6. Qualification of Production/Import/Distribution Facility

- 6.1. Producers/importers/distributors shall submit a written request to WSDOT for acceptance into CAP and provide the following:
- A copy of the producer/importer/distributor quality management plan meeting the requirements of Section 7 of QC 4.
  - A copy of the producer/importer/distributor testing laboratory's AASHTO accreditation.
  - One representative 10 pound sample for each type of fly ash or natural pozzolan along with the corresponding mill test report. Samples shall be taken in accordance with ASTM C311.
  - A copy of the Safety Data Sheet (SDS) as applicable for each sample submitted.
  - Mill test reports from the previous three (3) months from the producer/importer/distributor facility.
- 6.2. WSDOT will evaluate the submittal and may test the samples provided in accordance with Section 9 of QC 4. WSDOT will notify prospective producers/importers/distributors in writing after completion of the evaluation. All determinations of approval or rejection by WSDOT shall be final.
- 6.3. The producer/importer/distributor shall allow WSDOT to visit and observe the quality control activities and provide samples to WSDOT upon request.

## 7. Production/Import/Distribution Facility Quality Management Plan

- 7.1. The quality management plan, as a minimum, shall identify the following:
- Facility type.
  - Facility address.
  - Name, email address, and telephone number of the contact person responsible for the quality control of the facility.
  - List each quality control test method to be performed on each class of fly ash or natural pozzolan.
  - Name and address of the AAP testing laboratory performing specification compliance testing.
  - Declaration stating that if a test result indicates a lot of fly ash or natural pozzolan is not in compliance with the WSDOT specifications, the facility shall immediately notify WSDOT of the lot in question. A representative sample for the production period in question shall be sent to WSDOT for testing.
  - Description of the method and frequency of sampling, quality control testing, and specification compliance testing.
  - Class of fly ash or natural pozzolan the production/import/distribution facility intends to provide to WSDOT.
  - A statement of compliance with Section 5.
- 7.2. A new quality management plan shall be required whenever changes occur that cause the existing quality management plan to become inaccurate or invalid.

## 8. Documentation Requirements

- 8.1. Each producer/importer/distributor shall certify conformance to [Standard Specifications](#) for physical and chemical requirements of AASHTO M 295/ASTM C618 by means of a mill test report.
- 8.2. A mill test report shall be provided monthly by the producer/importer/distributor to WSDOT on a continuous basis for AASHTO M 295/ASTM C618 fly ash and natural pozzolan production.  
  
Fly ash and natural pozzolan mill test reports shall be in English and include the following information:
  - Name of producer/importer/distributor
  - Specific type of fly ash in accordance with [Standard Specifications](#) Section 9-23.9
  - Specific type of natural pozzolan in accordance with [Standard Specifications](#) Section 9-23.12
  - Unique identification number traceable to the date of production
  - Production date
- 8.3. A mill test report shall be provided by the fly ash or natural pozzolan producer/importer/distributor to WSDOT whenever a new shipment of AASHTO M 295/ASTM C618 imported fly ash or natural pozzolan is received for distribution.  
  
Fly ash and natural pozzolan test reports shall be in English and include the following information:
  - Name of producer/importer/distributor
  - Specific type of fly ash in accordance with [Standard Specifications](#) Section 9-23.9
  - Specific type of natural pozzolan in accordance with [Standard Specifications](#) Section 9-23.12
  - Unique identification number traceable to each shipment
  - Certification date
- 8.4. Separate sequences of mill test reports shall be provided for each individual production facility and a unique lot number traceable to a production run of fly ash or natural pozzolan shall identify each report.
- 8.5. The mill test report shall show the test results and the applicable specification of AASHTO M 295/ASTM C618 for each component or property tested and shall show the test requirements specified by WSDOT.
- 8.6. When a production facility does not produce fly ash or natural pozzolan in a given month, or no shipments are received by an importer/distributor, the producer/importer/distributor shall notify WSDOT with a no production report for each month of no production or shipment.
- 8.7. Mill test reports and no production reports shall be emailed to the CAP program at the following email address: [capprogram@wsdot.wa.gov](mailto:capprogram@wsdot.wa.gov).
- 8.8. The producer/importer/distributor shall notify WSDOT at the email address noted above of any temporary stops in production (greater than one month) or permanent stops in production.
- 8.9. All documentation shall be submitted to WSDOT within 28 days of the last day of the month of production or shipment.

## 9. Quarterly Split Sample

- 9.1. Producers/importers/distributors shall, on a quarterly basis, provide a split sample of each type of fly ash or natural pozzolan being produced.
- 9.2. For the purpose of this standard, quarters are defined as: January through March, April through June, July through September, and October through December.
- 9.3. Split samples shall be taken from production or shipment in accordance with the producer/importer/distributor's quality management plan.
- 9.4. The production sample shall be split into two portions (approximately 10 pounds each) for each type of fly ash or natural pozzolan being produced. One portion shall be retained by the producer/importer/ distributor and one portion shall be sent to WSDOT CAP.
- 9.5. The producer/importer/distributor testing laboratory shall conduct chemical and physical testing on their portion.
- 9.6. The sample submitted to WSDOT shall be labeled with the type and lot number traceable to the production run or lot of fly ash or natural pozzolan. WSDOT may elect to test the sample.
- 9.7. Samples shall be sent to:  
WSDOT State Materials Laboratory  
ATTN: Cement Acceptance Program  
1655 S Second Ave SW  
Tumwater, WA 98512-6951
- 9.8. The quarterly split sample mill test report shall be emailed to the CAP program at the following email address: [caprogram@wsdot.wa.gov](mailto:caprogram@wsdot.wa.gov)
- 9.9. The producer/importer/distributor shall email CAP at the email address noted in Section 9.8 if no fly ash or natural pozzolan was produced/imported/distributed during that quarter and no sample will be submitted.
- 9.10. The quarterly split samples, and accompanying mill test report, shall be submitted to WSDOT within 28 days of the date of sampling.

## 10. Comparison of Quarterly Split Sample Test Results

- 10.1. Results of the split sample testing shall conform to the applicable AASHTO or ASTM specification requirements.
- 10.2. If any discrepancy is identified between the producer/importer/distributors and WSDOT's test results the producer/importer/distributor shall prepare a response to WSDOT, within 30 days of being notified of discrepancy.
- 10.3. The response shall identify the cause of the discrepancy and describe any corrective action taken.

## 11. Revocation of Qualification

11.1. A producer/importer/distributor may have its qualification status revoked and be removed from the QPL if found in nonconformance with the [Standard Specifications](#) or this standard practice. Causes for removal from the QPL may include, but are not limited to, the following:

- Failure to comply with requirements of QC 4.
- Failing test results on produced/imported/distributed samples.
- Failure to notify WSDOT of changes in product formulation.
- Failure to send in a retained sample for additional testing for a production period with failing test results.

Prior to removing a producer/importer/distributor from the QPL, WSDOT will take appropriate measures to confirm the validity of the information and will confer with the producer/importer/distributor.

## 12. Requalification

12.1. Once a product has been removed from the QPL, the producer/importer/distributor may request reinstatement by providing the following written information to WSDOT:

- The root cause and corrective action taken to prevent future reoccurrences of the problem that caused the removal from the QPL.
- Updated quality management plan showing compliance with QC 4.
- Other information and test data as determined by WSDOT.

Provided there is a satisfactory resolution of the initial problem, at WSDOT's discretion, the product may either be reinstated into the QPL or the producer/importer/distributor may be required to reapply to the QPL. All costs of the QPL process shall be borne by the producer/importer/distributor.



## WSDOT Standard Practice QC 5

### ***Standard Practice for Ground Granulated Blast-Furnace Slag Producers/Suppliers That Certify Ground Granulated Blast-Furnace Slag***

#### 1. Scope

This standard specifies requirements for all producers/suppliers of ground granulated blast-furnace slag.

This standard may involve hazardous materials, operations and equipment. It does not address all of the safety problems associated with their use. It is the responsibility of those using this standard to consult and establish appropriate safety and health practices and determine the applicability of regulatory limitations prior to use.

#### 2. Referenced Documents

##### 2.1 AASHTO Standards

M 302 Standard Specifications for Ground Granulated Blast-Furnace Slag for Use in Concrete and Mortars

R 18 Establishing and Implementing a Quality Management System for Construction Materials Testing Laboratories

##### 2.2 ASTM Standards

C989 Standard Specifications for Ground Granulated Blast-Furnace Slag for Use in Concrete and Mortars

##### 2.3 WSDOT Standards and Documents

Current WSDOT [Standard Specifications](#) M 41-10

Current WSDOT [Qualified Products List](#)

#### 3. Terminology

3.1 **AASHTO** – American Association of State Highway and Transportation Officials

3.2 **ASTM** – American Society of Testing and Materials

3.3 **CCRL** – Cement and Concrete Reference Laboratory

3.4 **WSDOT** – Washington State Department of Transportation: the agency responsible for the final acceptance of ground granulated blast-furnace slag.

- 3.5 **QPL** – Qualified Products List
- 3.6 **Producer** – A production facility that has the capacity for producing and/or grinding ground granulated blast-furnace slag that meets the requirements of the [Standard Specifications](#) Section 9-23.10.
- 3.7 **Supplier** – A supplier stores and then delivers ground granulated blast-furnace slag produced by another entity to a concrete plant or another supplier.
- 3.8 **Supplier Certification** – Certification of ground granulated blast-furnace slag provided by the supplier or importer using representative test results obtained in accordance with an agency approved QC plan and approved testing lab.
- 3.9 **Quality Management Plan** – The producer/supplier plan to ensure that the ground granulated blast-furnace slag meets the specification requirements through a systematic program of sampling, testing, and inspection.
- 3.10 **Specification Compliance Testing** – Complete testing in accordance with the specification requirements for the material identified.
- 3.11 **Quality Control Testing** – Testing performed per the producer/supplier quality management plan to evaluate the production process.
- 3.12 **CAP** – Cement Acceptance Program
- 3.13 **Manufacturer’s Certification (Mill Test Report)** – A document provided by the producer/supplier showing the physical and chemical test results with specification limits for each property tested on the GGBFS.
- 3.14 **Ground granulated blast-furnace slag** – Ground granulated blast-furnace slag (GGBFS) meeting the requirements of [Standard Specifications](#) Section 9-23.10.
- 3.15 **No Production Report** – A document provided to WSDOT when ground granulated blast-furnace slag was not produced or shipped during a given month.

#### 4. Significance and Use

This standard specifies procedures for accepting ground granulated blast-furnace slag. This is accomplished by the cement acceptance program that evaluates quality control and specification compliance tests performed by the producers/suppliers according to their quality management plan. Products determined to meet the requirements of this standard are eligible for listing on the WSDOT Qualified Products List (QPL).

#### 5. Laboratory and Tester Requirements

The producers/suppliers testing laboratory used to conduct specification compliance testing for the quality management program shall be an AASHTO accredited laboratory and shall maintain AASHTO accreditation while participating in the WSDOT CAP program. Only laboratories that are participants in the CCRL on-site inspection and proficiency sample program and are accredited from the AASHTO Accreditation Program (AAP) are recognized as approved laboratories for the program.

## 6. Qualification of Producers/Suppliers

- 6.1 Producers/suppliers shall submit a written request to WSDOT for acceptance into CAP and provide the following:
- A copy of the producer/supplier quality management plan meeting the requirements of Section 7 of QC 5.
  - A copy of the producer/supplier testing laboratory's AASHTO accreditation. One representative 10 pound sample for each type of GGBFS along with the corresponding mill test report. Samples shall be taken in accordance with the QMP.
  - A copy of the Safety Data Sheet (SDS) as applicable for each sample submitted.
  - Mill test reports from the previous three (3) months from the producer/supplier facility.
- 6.2 WSDOT will evaluate the submittal and may test the samples provided in accordance with Section 9 of QC 5. WSDOT will notify prospective producers/suppliers in writing after completion of the evaluation. All determinations of approval or rejection by WSDOT shall be final.
- 6.3 The producer/supplier shall allow WSDOT to visit and observe the quality control activities and provide samples to WSDOT upon request.

## 7. Production/Supplier Facility Quality Management Plan

- 7.1 The quality management plan, as a minimum, shall identify the following:
- Facility type.
  - Facility location.
  - Name, email address, and telephone number of the contact person responsible for the quality control of the facility.
  - List each quality control test method to be performed on each grade of ground granulated blast-furnace slag.
  - Name and address of the AAP testing laboratory performing specification compliance testing.
  - Declaration stating that if a test result indicates a lot of GGBFS is not in compliance with the WSDOT specifications, the facility shall immediately notify WSDOT of the lot in question. A representative sample for the production period in question shall be sent to WSDOT for testing.
  - Description of the method and frequency for sampling, quality control testing, and specification compliance testing.
  - Grade of GGBFS the producer/supplier intends to provide to WSDOT.
  - A statement of compliance with Section 5.
- 7.2 A new quality management plan shall be required whenever changes occur that cause the existing quality management plan to become inaccurate or invalid.

## 8. Documentation Requirements

- 8.1 Each producer/supplier shall certify conformance to *Standard Specifications* for physical and chemical requirements of AASHTO M 302/ASTM C989 by means of a mill test report.
- 8.2 A mill test report shall be provided monthly by the producer/supplier to WSDOT on a continuous basis for AASHTO M 302/ASTM C989 GGBFS production.

Ground granulated blast-furnace slag test reports shall be in English and include the following information:

- Name of producer/supplier
- Specific grade of GGBFS in accordance with *Standard Specifications* Section 9-23.10
- Unique identification number traceable to the date of production
- Production date

- 8.3 A mill test report shall be provided by the GGBFS producer/supplier to WSDOT whenever a new shipment of AASHTO M 302/ASTM C989 imported GGBFS is received for distribution.

GGBFS reports shall be in English and include the following information:

- Name of producer/supplier
- Specific grade of GGBFS in accordance with *Standard Specifications* Section 9-23.10
- Unique identification number traceable to each shipment
- Certification date

- 8.4 Separate sequences of mill test reports shall be provided for each individual production facility and a unique lot number traceable to a production run on GGBFS shall identify each report.

- 8.5 The mill test report shall show the test results and the applicable specification of AASHTO M 302/ASTM C989 for each component or property tested and shall show the test requirements specified by WSDOT.

- 8.6 When a production facility does not produce GGBFS in a given month, or no shipments are received by a supplier, the producer/supplier shall notify WSDOT with a no production report for each month of no production or shipment.

- 8.7 Mill test reports and no production reports shall be emailed to the CAP program at the following email address: [caprogram@wsdot.wa.gov](mailto:caprogram@wsdot.wa.gov).

- 8.8 The producer/supplier shall notify WSDOT at the email address noted above of any temporary stops in production (greater than one month) or permanent stops in production.

- 8.9 All documentation shall be submitted to WSDOT within 28 days of the last day of the month of production or shipment.



## 9. Quarterly Split Sample

- 9.1 Producers/suppliers shall, on a quarterly basis, provide a split sample of each grade of ground granulated blast-furnace slag being produced.
- 9.2 For the purpose of this standard, quarters are defined as January through March, April through June, July through September, and October through December.
- 9.3 Split samples shall be taken from production or shipment in accordance with the producer/supplier's quality management plan.
- 9.4 The production sample shall be split into two portions (approximately 10 pounds each) for each grade of GGBFS being produced. One portion shall be retained by the producer/supplier and one portion shall be sent to WSDOT CAP.
- 9.5 The producer/supplier testing laboratory shall conduct chemical and physical testing on their portion.
- 9.6 The sample submitted to WSDOT shall be labeled with the grade and lot number traceable to the production run or lot of GGBFS. WSDOT may elect to test the sample.
- 9.7 Samples shall be sent to:

WSDOT State Materials Laboratory  
ATTN: Cement Acceptance Program  
1655 S Second Ave SW  
Tumwater, WA 98512-6951
- 9.8 The quarterly split sample mill test report shall be emailed to the CAP program at the following email address: [caprogram@wsdot.wa.gov](mailto:caprogram@wsdot.wa.gov)
- 9.9 The producer/supplier shall email CAP at the email address noted in Section 9.8 if no GGBFS was produced/supplied during that quarter and no sample will be submitted.
- 9.10 The quarterly split samples, and accompanying mill test report, shall be submitted to WSDOT within 28 days of the date of sampling.

## 10. Comparison of Split Sample Test Results

- 10.1 Results of the split sample testing shall conform to the applicable AASHTO or ASTM specification requirements.
- 10.2 If any discrepancy is identified between the producer/supplier and WSDOT's test results the producer/supplier shall prepare a response to WSDOT, within 30 days of being notified of discrepancy.
- 10.3 The response shall identify the cause of the discrepancy and describe any corrective action taken.

## 11. Revocation of Qualification

11.1 A producer/supplier may have its qualification status revoked and be removed from the QPL if found in nonconformance with the *Standard Specifications* or this standard practice. Causes for removal from the QPL may include, but are not limited to, the following:

- Failure to comply with requirements of QC 5.
- Failing test results on produced/supplied samples.
- Failure to notify WSDOT of changes in product formulation.
- Failure to send in a retained sample for additional testing for a production period with failing test results.

Prior to removing a producer/supplier from the QPL, WSDOT will take appropriate measures to confirm the validity of the information and will confer with the producer/supplier.

## 12. Requalification

12.1 Once a product has been removed from the QPL, the producer/supplier may request reinstatement by providing the following written information to WSDOT:

- The root cause and corrective action taken to prevent future reoccurrences of the problem that caused the removal from the QPL.
- Updated quality management plan showing compliance with QC 5.
- Other information and test data as determined by WSDOT.

Provided there is a satisfactory resolution of the initial problem, at WSDOT's discretion, the product may either be reinstated into the QPL or the producer/supplier may be required to reapply to the QPL. All costs of the QPL process shall be borne by the producer/supplier.



## WSDOT Standard Practice QC 6

### *Annual Prestressed Plant Review and Approval Process*

#### 1. Scope

This standard specifies requirements and procedures for WSDOT annual approval of all manufacturing facilities producing prestressed concrete girders or precast prestressed concrete members in accordance with WSDOT *Standard Specifications* Section 6-02.3(25). Standard Practice QC 6 also applies to precast concrete units that are prestressed as identified in WSDOT *Standard Specifications* Section 6-02.3(9).

#### 2. Referenced Documents

- 2.1 Precast/Prestressed Concrete Institute Certification Program
- 2.2 WSDOT Qualified Products List
- 2.3 WSDOT Standard Specification

#### 3. Terminology

- 3.1 **Plant** – Manufacturing facility producing prestressed concrete members with single plant location.
- 3.2 **NRMCA** – National Ready Mix Concrete Association
- 3.3 **PCI** – Precast/Prestressed Concrete Institute
- 3.4 **RAM** - Request for Approval of Material (WSDOT [Form 350-071](#)) document submitted by the plant, identifying their material sources for WSDOT approval.
- 3.5 **Quality Control** – Quality control inspection and documentation provided by the plant.
- 3.6 **QPL** – WSDOT Qualified Products List
- 3.7 **WSDOT** – Washington State Department of Transportation
- 3.8 **WSDOT Annual Approval** – The approval process defined in WSDOT Standard Practice QC 6.
- 3.9 **WSDOT Fabrication Inspector** – Quality Assurance inspector provided by the WSDOT Headquarters Materials Laboratory Materials and Fabrication Inspection Office.

#### 4. Significance and Use

- 4.1 This Standard Practice specifies procedures for approving plants on an annual basis and maintaining a plant approval document reviewed annually. Submittal documents pre approve specific documentation identified in this Standard Practice; replacing the requirement for contract specific submittals. Modifications can be made to the plants submittal at any time during the annual approval period.

#### 5. Annual Plant Approval Requirements

- 5.1 Plants shall be initially approved through the QPL or RAM approval process. Plants shall not begin fabricating prestressed members prior to receiving WSDOT annual plant approval.
- 5.2 Maintain current PCI certification for the type of prestressed member being manufactured.
- 5.3 Maintain quality control staff meeting the training and certification requirements specified by the PCI plant certification program.
- 5.4 Submit and maintain an annual approval document detailed in Section 6. Plants must complete and maintain all submittal requirements to remain in active approval status.
- 5.5 Submit annually by December 1<sup>st</sup> a document identifying the plant has reviewed their annual approval document and identifies whether the plant approval document remains unchanged, or details any anticipated revisions.
- 5.6 Successful completion of initial WSDOT plant approval detailed in Section 7 or successful maintenance of annual approval status detailed in Section 10.

#### 6. Plant Submittal Requirement

- 6.1 Plants shall initially submit a document for annual approval that covers the submittal requirements of this section starting with Section 6.1.1. The document may be submitted by mail or submitted electronically. Submit documents to the WSDOT Transportation Technical Engineer.
- 6.1.1 Table of Contents
- 6.1.2 Table of Organization.
- 6.1.3 RAM documents. Submit RAM documents for the following materials.
- Concrete Ready Mix Batch Plant (as applicable)
  - Epoxy Coated Reinforcing Steel
  - Fabrication Facilities Manufacturing Welded Embeds and Fabricating Reinforcing Steel
  - Prestress Strand
  - Reinforcing Steel

- 6.1.4 Concrete mix designs. Submit mix designs on the latest revision of WSDOT Form 350-040. Mix designs are to be filled out completely. Aggregate, cement, slag, and admixtures must be from WSDOT approved sources. Mix design submittal shall include the following for each mix design;
- Compressive strength break history. A minimum of 15 sets (2 cylinders per set)
  - Cement mill certification report
  - Chloride Ion test results
- 6.1.5 Curing procedures. Submit the procedure that will be used to cure prestressed members. Identify whether accelerated curing will be used and detail the procedure for monitoring and documenting curing operations.
- 6.1.6 Fabrication procedures and drawings. This submittal is for standard fabrication procedures and specialized fabrication procedures. Specialized procedures may be added to the annual plant submittal as approved by the WSDOT Bridge and Structures Office, to facilitate fabrication of prestressed members. Examples of specialized procedures are as follows:
- Tensioning and Detensioning procedures
  - Hold down devices
  - Other procedures and drawings as determined by the Plant.
- 6.1.7 Weld procedures. Submit weld procedures for welding of embed plates or other structures as applicable to the plants manufacturing process.
- 6.1.8 Repair procedures. Submit repair procedures for anticipated repair scenarios. Approved repair procedures can be used during fabrication of prestressed members without further WSDOT engineering approval. Repair procedures must be detailed, including dimensional limits, and specific repair materials identified by material type, and brand name. Submittal shall include catalog cuts for repair materials.
- 6.1.9 Quality control plan. Submit quality control procedures and inspection forms. Inspection forms shall include information for the following.
- Pre Pour Inspection Report
  - Wet Concrete Testing Report
  - Stressing Record
  - Compressive Strength Testing Report
  - Non Conformance Report
  - Post Pour Inspection Report
- 6.1.10 Ready mix batch plant NRMCA as applicable. Not required for plants in house batch plant.

- 6.1.11 Problem resolution form. Submit a plant specific problem resolution form. Appendix "B" has an example of the Problem Resolution Form. This form is used to expedite resolution of construction issues encountered during fabrication of prestressed concrete members.
- 6.1.12 Certificate of Compliance Document: Submit the form that will be used for the Certificate of Compliance document.
- 6.1.13 Final documentation package. Detail or outline the documents that will be provided to the WSDOT Materials and Fabrication Inspector prior to WSDOT final approval of prestressed members. Documents required in the final document package are as listed below.
- Pre Pour Inspection Report
  - Wet Concrete Testing Report
  - Compressive Strength Testing Report
  - Post Pour Inspection Report
  - Gradation Reports
  - Cure Charts for accelerated curing
  - Stressing Records
  - Non Conformance Reports
  - Problem Resolution documents
  - Certificate of Compliance
  - Certificate of Materials Origin (for projects with "Buy America" Requirement, WSDOT Form 350-109)
  - Mill certs
    - Cement
    - Epoxy Coated Reinforcing Steel
    - Fly Ash
    - Micro Silica
    - Prestress Strand
    - Reinforcing Steel
    - Slag
    - Steel components

## 7. Initial Plant Approval Process

- 7.1 Upon receiving the plants initial submittal, WSDOT will review the contents of the submittal in preparation for WSDOT's initial plant approval meeting with representatives of the plant.
- 7.2 WSDOT will be allowed 90 days for review of the plants initial submittal document. Time for review will be longer if submittals are incomplete.

- 7.3 WSDOT review responsibilities.
  - 7.3.1 WSDOT Transportation Technical Engineer. Overall responsibility for annual approval and submittal review process. Coordinates all annual approval submittal activities. Reviews for acceptance all documentation with the exception of mix designs, specialized fabrication procedures, and repair procedures.
  - 7.3.2 WSDOT Headquarters Materials Laboratory Fabrication Inspection Office. Responsible for review and approval of mix designs.
  - 7.3.3 WSDOT Construction Office. Responsible for review and approval of repair procedures.
  - 7.3.4 WSDOT Bridge and Structures Office. Responsible for approval of specialized fabrication procedures, and review and approval of welding procedures.
- 7.4 Review process.
  - 7.4.1 The WSDOT Transportation Technical Engineer will review portions of the plant submittal and will send specific sections referenced in Section 7.3 to the respective approving authorities.
  - 7.4.2 Approving authorities will send reviewed documents back to the WSDOT Transportation Technical Engineer.
  - 7.4.3 The WSDOT Transportation Technical Engineer will review the status of the submittals returned from the approving authorities and incorporate the documents into the annual plant approval document.
  - 7.4.4 Submittal documents will be signed or stamped “Approved”, “Approved as Noted”, “Not Approved”, or Accepted depending on their review status.
  - 7.4.5 RAM documents will be coded with acceptance codes by the WSDOT Transportation Technical Engineer. RAM codes for specific items are referenced in Appendix “C” of this Standard Practice.
  - 7.4.6 The WSDOT Transportation Technical Engineer will make an itemized list of review comments and action items and will place them at the front of the annual submittal document returned to the plant at the time of the initial plant approval meeting. If time allows, the Transportation Technical Engineer will work directly with representatives from the plant to address review comments prior to the initial plant approval meeting.
  - 7.4.7 The WSDOT Transportation Technical Engineer will schedule the initial plant approval meeting and will send the plant a letter and email notifying them of the date and time WSDOT will be at the plant for the initial plant approval meeting.

- 7.4.8 WSDOT will perform a formal audit of the plants facility, and operating and quality control procedures prior to the initial plant approval meeting. WSDOT will contact the plant and inform them of the date and time a WSDOT inspector will be at the plant for an inspection audit. The audit will follow the outline detailed in Appendix A.
- 7.4.9 WSDOT will provide the plant with an electronic version of the reviewed annual approval document within 30 days following completion of the initial plant approval meeting.

## 8. Initial Plant Approval Meeting

### 8.1 Scheduling

- 8.1.1 An initial plant approval meeting will be scheduled after WSDOT has completed its review of the plants initial submittal. The meeting will be held at the plants physical location. WSDOT will notify the plant of the date and time the meeting will be held.

### 8.2 Attendees

- 8.2.1 WSDOT attendees will include at a minimum, the WSDOT Transportation Technical Engineer and a supervising inspector from the Materials and Fabrication Inspection Office.
- 8.2.2 Attendees from the plant shall include at a minimum the plant manager, production manager, and quality control manager, or their respective representatives.

### 8.3 Meeting Agenda

- 8.3.1 The meeting agenda will focus on comments from WSDOT's review of the plants annual approval document submittal, and WSDOT's plant inspection audit completed prior to the meeting.
- 8.3.2 WSDOT will inform the plant of their approval status upon completion of the initial approval meeting. Any deficiencies that would prevent approval will be identified and discussed during the meeting.

## 9. Initial Plant Approval Status Notification

- 9.1 Within 30 days following the initial plant approval meeting, the WSDOT Transportation Technical Engineer will send the plant a letter informing the plant of their approval status and the period of effectiveness. Any deficiencies identified during the annual plant review and audit that would prevent annual approval will be identified in the letter.



## 10. Maintenance of Plant Approval Status After Initial Approval

- 10.1 Annual approval documents will remain in affect indefinitely as long as the document is maintained each calendar year.
- 10.2 The WSDOT Transportation Technical Engineer will send each plant a letter in October requesting a document identifying the plant has reviewed their annual approval document and identifies whether the plant approval documents remain unchanged, or details any anticipated revisions. The letter will also detail any changes to WSDOT's program that would affect the annual approval document. The document and any revisions ready for submittal shall be sent electronically to the WSDOT Transportation Technical Engineer no later than December 1<sup>st</sup>.
- 10.3 Revisions to mix designs will be processed through the QPL or reviewed during WSDOT project specific work activities. WSDOT will provide plants with a cost estimate for review of mix designs submitted through the QPL process. Costs associated with mix design reviews for project specific work activities will be based on the same process for review through the RAM process. Only mix designs reviewed by the WSDOT Headquarters Materials Laboratory will be added to the annual plant approval document.
- 10.4 Revisions submitted by the plant will be reviewed as detailed in Section 7.4.1 through 7.4.5.
- 10.5 The WSDOT Transportation Technical Engineer will review annual plant approval documents in December. Review comments will be provided to plants for their action by January 15<sup>th</sup>. Upon resolution of review comments, the WSDOT Transportation Technical Engineer will document revisions to the annual approval document and will maintain revision control by adding "Approved", "Approved as Noted", "Not Approved", or "Accepted" revisions to the document and providing plants with an electronic version of the plants complete approval document. WSDOT will provide a revision control document at the front of the annual approval document, which details the changes from the previous version.
- 10.6 Onsite inspection audits will be performed by WSDOT when the plant starts its first project each calendar year. Audits will not be performed by WSDOT until there is work taking place. If a calendar year passes without an active project, WSDOT will perform an inspection audit when WSDOT project specific work starts. The audit will follow the outline detailed in Appendix A.

## 11. Annual Maintenance Approval Status Notification

- 11.1 Upon successful completion of WSDOT's annual plant approval document review and onsite plant inspection audit as applicable, the WSDOT Transportation Technical Engineer will send the plant a letter informing the plant of their approval status and the period of effectiveness. Any deficiencies identified during the annual plant review that would prevent annual approval will be identified in the letter.

# WSDOT Standard Practice QC 6

## Appendix A Precast / Prestress Plant Inspection Audit

Plant: \_\_\_\_\_ Date: \_\_\_\_\_

Phone Number: \_\_\_\_\_ Contact Person: \_\_\_\_\_

Plant Reviewed by: \_\_\_\_\_

Review Results: Acceptable      Unacceptable

### Materials

#### Concrete Cylinders

Is cylinder fabrication and testing in accordance with WSDOT test methods?      Yes      No

Does cylinder storage comply with specifications?      Yes      No

Is cylinder capping acceptable?      Yes      No

Method of capping:      Sulphur      Rubber caps      Other \_\_\_\_\_

What types of molds are used?      Paper      Plastic      Steel      Securer

Is cylinder testing machine calibrated?      Yes      No

Comments: \_\_\_\_\_

#### Cement

Is cement from an approved source?      Yes      No

Are cement certifications available?      Yes      No

Is cement storage acceptable?      Yes      No

Comments: \_\_\_\_\_

**Aggregate**

Has aggregate source been approved by WSDOT? Yes No

Does plant use WSDOT grading? Yes No

Is aggregate sampled and tested prior to use? Yes No

Is aggregate storage acceptable? Yes No

Comments: \_\_\_\_\_

**Reinforcing Steel**

Are mill test certificates available? Yes No

Is fabrication acceptable? Yes No

Is storage acceptable? Yes No

Comments: \_\_\_\_\_

**Forms**

Are forms clean, straight and in good condition? Yes No

Are forms checked for dimensions prior to use? Yes No

Comments: \_\_\_\_\_

**Batch Plant**

Does batch plant meet the certification requirements of the WSDOT Std. Spec. Yes No

Date of scale calibration: \_\_\_\_\_

Comments: \_\_\_\_\_

**Fabrication**

**Set up**

Is reinforcing steel placed per contract	Yes	No
Is steel tied according to specifications and held in place during concrete placement?	Yes	No
Is the plant aware tack welding is not permitted?	Yes	No
Is there a Plant QC hold point for inspection prior to setting forms?	Yes	No

Comments: \_\_\_\_\_

**Concrete Placement**

Is concrete delivered in a timely manner?	Yes	No
Is plant using approved concrete mix design?	Yes	No
Is required concrete testing being done?	Yes	No
Is there adequate equipment for concrete placement in forms?	Yes	No
Is concrete placed per specifications?	Yes	No

Comments: \_\_\_\_\_

**Curing**

Is temperature measuring equipment acceptable?	Yes	No
Is product protected during curing?	Yes	No
Are test cylinders cured under same conditions as product?	Yes	No

What type of curing system is used?

Radiant \_\_\_\_\_

Hot air \_\_\_\_\_

Convection \_\_\_\_\_

Conducted Steam \_\_\_\_\_

Other \_\_\_\_\_

Comments: \_\_\_\_\_

## Stripping Procedures

Are concrete cylinders for verification of stripping strength representative of the product? Yes No

Is required stripping strength being verified with cylinder breaks prior to stripping? Yes No

Comments: \_\_\_\_\_

## Inspection

Does plant inspection staff have a good understanding of their job responsibilities? Yes No

Does plant inspection staff have adequate Training? Yes No

Is plant inspection staff familiar with the WSDOT Annual Approval process and procedures? Yes No

Are approved shop drawings, plans, and calculations available? Yes No

Are quality control procedures being followed? Yes No

Are quality control reports being filled out Properly? Yes No

Has the plant quality control department verified product repairs, workmanship, and finish are acceptable? Yes No

Comments: \_\_\_\_\_

## Product Handling and Storage

Are products handled and stored properly? Yes No

Comments: \_\_\_\_\_

## Overall Review Comments

## Review Attendees

Name	Job Description	Phone/Email

### Appendix B Manufacturers Name Precast Problem Resolution Request

Date: \_\_\_\_\_

Submitted To: \_\_\_\_\_

WSDOT Construction Engineer      Email: PrecastPRR@wsdot.wa.gov

Contractor \_\_\_\_\_

Fax: \_\_\_\_\_/Email: \_\_\_\_\_

WSDOT Contract No: \_\_\_\_\_

Project Name: \_\_\_\_\_

Company Name: \_\_\_\_\_

Submitted By (Contact Person): \_\_\_\_\_

Telephone No: \_\_\_\_\_ Fax No: \_\_\_\_\_

Email: \_\_\_\_\_

Priority:    High      Medium      Low

Request Response Time: \_\_\_\_\_

Description of Problem:

Proposed Resolution:

WSDOT Fabrication Inspector's Name and Signature:

\_\_\_\_\_  
Name

\_\_\_\_\_  
Signature

## Appendix C RAM Acceptance Codes

Products	RAM Code
Concrete Ready Mix Batch Plant	8
Epoxy Coated Reinforcing Steel	2, 5, 6
Fabrication Facilities (Steel Embeds & Fabricating Rebar)	8
Prestress Strand	1, 2, 6
Reinforcing Steel	2, 6

### RAM Acceptance Action Codes

- 1) Acceptance based upon 'Satisfactory' Test Report for samples of materials to be incorporated into the project.
- 2) Mfg. Cert. of Compliance for 'Acceptance' prior to use of material.
- 3) Catalog Cuts for 'Acceptance' prior to use of material.
- 4) Not Listed (No relevance to annual submittal process)
- 5) Only Materials Tagged 'Approved for Shipment'
- 6) Submit Certificate of Materials Origin to Project Engineer Office.(Only for projects with "Buy America" requirement.
- 7) Not Listed (No relevance to annual submittal process)
- 8) Source Approved
- 9) Approval Withheld; submit samples for preliminary evaluation
- 10) Approval Withheld
- 11) Miscellaneous Acceptance Criteria





## WSDOT Standard Practice QC 7

### *Annual Precast Plant Review and Approval Process*

#### 1. Scope

This standard specifies requirements and procedures for WSDOT annual approval of all manufacturing facilities producing precast concrete structures in accordance with WSDOT *Standard Specification* Section 6-02.3(9).

#### 2. Referenced Documents

#### 3. WSDOT Qualified Products List

3.1 WSDOT Standard Specification

#### 4. Terminology

4.1 **Plant** – Manufacturing facility producing precast concrete structures with single plant location.

4.2 **NRMCA** – National Ready Mix Concrete Association

4.3 **ICBO** – International Congress Building Officials

4.4 **ICC-ES** – International Code Council Evaluation Services

4.5 **PCI** – Precast/Prestressed Concrete Institute

4.6 **NPCA** – National Precast Concrete Association

4.7 **RAM** - Request for Approval of Material (WSDOT Form 350-071) submitted by the plant, identifying their material sources for WSDOT approval.

4.8 **Quality Control** – Quality control inspection and documentation provided by the plant.

4.9 **QPL** – WSDOT Qualified Products List

4.10 **WSDOT** – Washington State Department of Transportation

4.11 **WSDOT Annual Approval** – The certification process defined in WSDOT Standard Practice QC 7.

4.12 **WSDOT Fabrication Inspector** – Quality Assurance inspector provided by the WSDOT Headquarters Materials Laboratory Materials and Fabrication Inspection Office.

#### 5. Significance and Use

5.1 This Standard Practice specifies procedures for approving plants on an annual basis and maintaining a plant approval document reviewed annually. Submittal documents pre approve specific documentation identified in this Standard Practice; replacing the requirement for contract specific submittals. Modifications can be made to the plants submittal at any time during the annual approval period.

## 6. Annual Plant Approval Requirements

- 6.1 Plants shall be initially approved through the QPL or RAM approval process. Plants shall not begin fabricating precast members prior to receiving WSDOT annual plant approval.
- 6.2 Maintain current PCI, or NPCA certification, or maintain current status as a recognized fabricator by ICBO or ICC-ES.
- 6.3 Maintain quality control staff meeting the training and certification requirements specified by the certifying organization.
- 6.4 Submit and maintain an annual approval document detailed in Section 6. Plants must complete and maintain all submittal requirements to remain in active approval status.
- 6.5 Submit annually by December 1st a document identifying the plant has reviewed their annual approval document and identifies whether the plant approval document remains unchanged, or details any anticipated revisions.
- 6.6 Successful completion of initial WSDOT plant approval detailed in Section 8 or successful maintenance of annual approval status detailed in Section 11.

## 7. Plant Submittal Requirement

- 7.1 Plants shall initially submit a document for annual approval that covers the submittal requirements of this section starting with Section 7.1.1. The document may be submitted by mail or submitted electronically. Submit documents to the WSDOT Transportation Technical Engineer.
  - 7.1.1 Table of Contents
  - 7.1.2 Table of Organization
  - 7.1.3 RAM documents. Submit RAM documents for the following materials.
    - Concrete Ready Mix Batch Plant (as applicable)
    - Epoxy Coated Reinforcing Steel
    - Fabrication Facilities Manufacturing Welded Embeds and Fabricating Reinforcing Steel
    - Reinforcing Steel
  - 7.1.4 Concrete mix designs. Submit mix designs on the latest revision of WSDOT Form 350-040. Mix designs are to be filled out completely. Aggregate, cement, slag, and admixtures must be from WSDOT approved sources.

Mix design submittal shall include the following for each mix design;

    - Compressive strength break history. A minimum of 15 sets (2 cylinders per set)
    - Cement mill certification report
    - Chloride Ion test results
    - Self-compacting concrete test data
  - 7.1.5 Curing procedures. Submit the procedure that will be used to cure precast members. Identify whether accelerated curing will be used and detail the procedure for monitoring and documenting curing operations.
  - 7.1.6 Fabrication procedures and drawings. This submittal is for standard fabrication procedures and specialized fabrication procedures. Specialized procedures may be added to the annual plant submittal as approved by the WSDOT Bridge and Structures Office, to facilitate fabrication of precast structures.

- 7.1.7 Weld procedures. Submit weld procedures for welding of embed plates or other structures as applicable to the plants manufacturing process.
- 7.1.8 Repair procedures. Submit repair procedures for anticipated repair scenarios. Approved repair procedures can be used during fabrication of precast members without further WSDOT engineering approval. Repair procedures must be detailed, including dimensional limits, and specific repair materials identified by material type, and brand name. Submittal shall include catalog cuts for repair materials.
- 7.1.9 Quality control plan. Submit quality control procedures and inspection forms. Inspection forms shall include information for the following.
- Pre Pour Inspection Report
  - Wet Concrete Testing Report
  - Compressive Strength Testing Report
  - Non Conformance Report
  - Post Pour Inspection Report
- 7.1.10 Ready mix batch plant NRMCA certification documentation as applicable. Not required for plants in house batch plant.
- 7.1.11 Problem resolution form. Submit a plant specific problem resolution form. Appendix “B” has an example of the Problem Resolution Form. This form is used to expedite resolution of construction issues encountered during fabrication of precast concrete structures.
- 7.1.12 Certificate of Compliance Document: Submit the form that will be used for the Certificate of Compliance document.
- 7.1.13 Final documentation package. Detail or outline the documents that will be provided to the WSDOT Materials and Fabrication Inspector prior to WSDOT final approval of precast members. Documents required in the final document package are as listed below.
- Pre Pour Inspection Report
  - Wet Concrete Testing Report
  - Compressive Strength Testing Report
  - Post Pour Inspection Report
  - Gradation Reports
  - Cure Charts for accelerated curing
  - Non Conformance Reports
  - Problem Resolution documents
  - Certificate of Compliance
  - Certificate of Materials Origin (for projects with “Buy America” Requirement, WSDOT Form 350-109)
  - Mill certs
    - Cement
    - Epoxy Coated Reinforcing Steel
    - Fly Ash
    - Micro Silica
    - Reinforcing Steel
    - Slag
    - Steel components

## 8. Initial Plant Approval Process

- 8.3.1 WSDOT Transportation Technical Engineer. Overall responsibility for annual approval and submittal review process. Coordinates all annual approval submittal activities. Reviews for acceptance all documentation with the exception of mix designs, specialized fabrication procedures, and repair procedures.
- 8.3.2 WSDOT Headquarters Materials Laboratory Fabrication Inspection Office. Responsible for review and approval of mix designs.
- 8.3 WSDOT review responsibilities.
  - 8.3.1 WSDOT Fabrication and Coatings Engineer. Overall responsibility for annual approval and submittal review process. Coordinates all annual approval submittal activities. Reviews for acceptance all documentation with the exception of mix designs, specialized fabrication procedures, and repair procedures.
  - 8.3.2 WSDOT Headquarters Materials Laboratory Fabrication Inspection Office. Responsible for review and acceptance of mix designs.
  - 8.3.3 WSDOT Construction Office. Responsible for review and approval of repair procedures.
  - 8.3.4 WSDOT Bridge and Structures Office. Responsible for approval of specialized fabrication procedures, and review and approval of welding procedures.
- 8.4 Review process.
  - 8.4.1 The WSDOT Transportation Technical Engineer will review portions of the plant submittal and will send specific sections referenced in Section 8.3 to the respective approving authorities.
  - 8.4.2 Approving authorities will send reviewed documents back to the WSDOT Transportation Technical Engineer.
  - 8.4.3 The WSDOT Transportation Technical Engineer will review the status of the submittals returned from the approving authorities and incorporate the documents into the annual plant approval document.
  - 8.4.4 Submittal documents will be signed or stamped “Approved”, “Approved as Noted”, “Not Approved”, or “Accepted” depending on their review status.
  - 8.4.5 RAM documents will be coded with acceptance codes by the WSDOT Transportation Technical Engineer. RAM codes for specific items are referenced in Appendix “C” of this Standard Practice.
  - 8.4.6 The WSDOT Transportation Technical Engineer will make an itemized list of review comments and action items and will place them at the front of the annual submittal document returned to the plant at the time of the initial plant approval meeting. If time allows, the WSDOT Transportation Technical Engineer will work directly with representatives from the plant to address review comments prior to the initial plant approval meeting.

- 8.4.7 The WSDOT Transportation Technical Engineer will schedule the initial plant approval meeting and will send the plant a letter and email notifying them of the date and time WSDOT will be at the plant for the initial plant approval meeting.
- 8.4.8 WSDOT will perform a formal audit of the plants facility, and operating and quality control procedures prior to the initial plant approval meeting. WSDOT will contact the plant and inform them of the date and time a WSDOT inspector will be at the plant for an inspection audit. The audit will follow the outline detailed in Appendix "A".
- 8.4.9 WSDOT will provide the plant with an electronic version of the reviewed annual approval document within 30 days following completion of the initial plant approval meeting.

## 9. Initial Plant Approval Meeting

### 9.1 Scheduling

- 9.1.1 An initial plant approval meeting will be scheduled after WSDOT has completed its review of the plants initial submittal. The meeting will be held at the plants physical location. WSDOT will notify the plant of the date and time the meeting will be held.

### 9.2 Attendees

- 9.2.1 WSDOT attendees will include at a minimum, the WSDOT Transportation Technical Engineer and a supervising inspector from the Materials and Fabrication Inspection Office.
- 9.2.2 Attendees from the plant shall include at a minimum the plant manager, production manager, and quality control manager, or their respective representatives.

### 9.3 Meeting Agenda

- 9.3.1 The meeting agenda will focus on comments from WSDOT's review of the plants annual approval document submittal, and WSDOT's plant inspection audit completed prior to the meeting.
- 9.3.2 WSDOT will inform the plant of their approval status upon completion of the initial approval meeting. Any deficiencies that would prevent approval will be identified and discussed during the meeting.

## 10. Initial Plant Approval Status Notification

- 10.1 Within 30 days following the initial plant approval meeting, the WSDOT Transportation Technical Engineer will send the plant a letter informing the plant of their approval status and the period of effectiveness. Any deficiencies identified during the annual plant review audit that would prevent annual approval will be identified in the letter.

## 11. Maintenance of Plant Approval Status After Initial Approval

- 11.1 Annual approval documents will remain in affect indefinitely as long as the document is maintained each calendar year.
- 11.2 The WSDOT Transportation Technical Engineer will send each plant a letter in October requesting a document identifying the plant has reviewed their annual approval document and identifies whether the plant approval documents remain unchanged, or details any anticipated revisions. The letter will also detail any changes to WSDOT's program that would affect the annual approval document. The document and any revisions ready for submittal shall be sent electronically to the WSDOT Transportation Technical Engineer no later than December 1<sup>st</sup>.
- 11.3 Revisions to mix designs will be processed through the QPL or reviewed during WSDOT project specific work activities. WSDOT will provide plants with a cost estimate for review of mix designs submitted through the QPL process. Costs associated with mix design reviews for project specific work activities will be based on the same process for review through the RAM process. Only mix designs reviewed by the WSDOT Headquarters Materials Laboratory will be added to the annual plant approval document.
- 11.4 Revisions submitted by the plant will be reviewed as detailed in Section 8.4.1 through 8.4.5.
- 11.5 The WSDOT Transportation Technical Engineer will review annual plant approval documents in December. Review comments will be provided to plants for their action by January 15th. Upon resolution of review comments, the WSDOT Transportation Technical Engineer will document revisions to the annual approval document and will maintain revision control by adding "Approved", "Approved as Noted", "Not approved", or "Accepted" revisions to the document and providing plants with an electronic version of the plants complete approval document. WSDOT will provide a revision control document at the front of the annual approval document, which details the changes from the previous version.
- 11.6 Onsite inspection audits will be performed by WSDOT when the plant starts its first project each calendar year. Audits will not be performed by WSDOT until there is work taking place. If a calendar year passes without an active project, WSDOT will perform an inspection audit when WSDOT project specific work starts. The audit will follow the outline detailed in Appendix A.

## 12. Annual Maintenance Approval Status Notification

- 12.1 Upon successful completion of WSDOT's annual plant approval document review and onsite plant inspection as applicable, the WSDOT Transportation Technical Engineer will send the plant a letter informing the plant of their approval status and the period of effectiveness. Any deficiencies identified during the annual plant review that would prevent annual approval will be identified in the letter.

## Appendix A Precast / Prestress Plant Inspection Audit

Plant: \_\_\_\_\_ Date: \_\_\_\_\_

Phone Number: \_\_\_\_\_ Contact Person: \_\_\_\_\_

Plant Reviewed by: \_\_\_\_\_

Review Results: Acceptable      Unacceptable

### Materials

#### Concrete Cylinders

Is cylinder fabrication and testing in accordance with WSDOT test methods?      Yes      No

Does cylinder storage comply with specifications?      Yes      No

Is cylinder capping acceptable?      Yes      No

Method of capping:      Sulphur      Rubber caps      Other \_\_\_\_\_

What types of molds are used?      Paper      Plastic      Steel      Securer

Is cylinder testing machine calibrated?      Yes      No

Comments: \_\_\_\_\_

#### Cement

Is cement from an approved source?      Yes      No

Are cement certifications available?      Yes      No

Is cement storage acceptable?      Yes      No

Comments: \_\_\_\_\_

#### Aggregate

Has aggregate source been approved by WSDOT?      Yes      No

Does plant use WSDOT grading?      Yes      No

Is aggregate sampled and tested prior to use?      Yes      No

Is aggregate storage acceptable?      Yes      No

Comments: \_\_\_\_\_

**Reinforcing Steel**

Are mill test certificates available? Yes No

Is fabrication acceptable? Yes No

Is storage acceptable? Yes No

Comments: \_\_\_\_\_

**Forms**

Are forms clean, straight and in good condition? Yes No

Are forms checked for dimensions prior to use? Yes No

Comments: \_\_\_\_\_

**Batch Plant**

Does batch plant meet the certification requirements of the WSDOT Std. Spec. Yes No

Date of scale calibration: \_\_\_\_\_

Comments: \_\_\_\_\_

**Fabrication**

**Set Up**

Is reinforcing steel placed per contract Yes No

Is steel tied according to specifications and held in place during concrete placement? Yes No

Is the plant aware tack welding is not permitted? Yes No

Is there a Plant QC hold point for inspection prior to setting forms? Yes No

Comments: \_\_\_\_\_

**Concrete Placement**

Is concrete delivered in a timely manner? Yes No

Is plant using approved concrete mix design? Yes No

Is required concrete testing being done? Yes No

Is there adequate equipment for concrete placement in forms? Yes No

Is concrete placed per specifications? Yes No

Comments: \_\_\_\_\_



**Curing**

Is temperature measuring equipment acceptable? Yes No

Is product protected during curing? Yes No

Are test cylinders cured under same conditions as product? Yes No

What type of curing system is used?

Radiant \_\_\_\_\_

Hot air \_\_\_\_\_

Convection \_\_\_\_\_

Conducted Steam \_\_\_\_\_

Other \_\_\_\_\_

Comments: \_\_\_\_\_

**Stripping Procedures**

Are concrete cylinders for verification of stripping strength representative of the product? Yes No

Is required stripping strength being verified with cylinder breaks prior to stripping? Yes No

Comments: \_\_\_\_\_

**Inspection**

Does plant inspection staff have a good understanding of their job responsibilities? Yes No

Does plant inspection staff have adequate Training? Yes No

Is plant inspection staff familiar with the WSDOT Annual Approval process and procedures? Yes No

Are approved shop drawings, plans, and calculations available? Yes No

Are quality control procedures being followed? Yes No

Are quality control reports being filled out Properly? Yes No

Has the plant quality control department verified product repairs, workmanship, and finish are acceptable? Yes No

Comments: \_\_\_\_\_

**Product Handling and Storage**

Are products handled and stored properly? Yes No

Comments: \_\_\_\_\_

**Overall Review Comments**

**Review Attendees**

Name	Job Description	Phone/Email

**Appendix B Manufacturers Name Precast Problem Resolution Request**

Date: \_\_\_\_\_

Submitted To: \_\_\_\_\_

WSDOT Construction Engineer

Email: PrecastPRR@wsdot.wa.gov

Contractor \_\_\_\_\_

Fax: \_\_\_\_\_/Email: \_\_\_\_\_

WSDOT Contract No: \_\_\_\_\_

Project Name: \_\_\_\_\_

Company Name: \_\_\_\_\_

Submitted By (Contact Person): \_\_\_\_\_

Telephone No: \_\_\_\_\_

Fax No: \_\_\_\_\_

Email: \_\_\_\_\_

Priority: High Medium Low

Request Response Time: \_\_\_\_\_

Description of Problem:

Proposed Resolution:

WSDOT Fabrication Inspector's Name and Signature:

\_\_\_\_\_  
Name

\_\_\_\_\_  
Signature

### Appendix C AM Acceptance Codes

Products	RAM Code
Concrete Ready Mix Batch Plant	8
Epoxy Coated Reinforcing Steel	2, 5, 6
Fabrication Facilities (Steel Embeds & Fabricating Rebar)	8
Reinforcing Steel	2, 6

### RAM Acceptance Action Codes

- 1) Acceptance based upon 'Satisfactory' Test Report for samples of materials to be incorporated into the project.
- 2) Mfg. Cert. of Compliance for 'Acceptance' prior to use of material.
- 3) Catalog Cuts for 'Acceptance' prior to use of material.
- 4) Not Listed (No relevance to annual submittal process)
- 5) Only Materials Tagged 'Approved for Shipment'
- 6) Submit Certificate of Materials Origin to Project Engineer Office. (Only for projects with "Buy America" requirement.
- 7) Not Listed (No relevance to annual submittal process)
- 8) Source Approved
- 9) Approval Withheld; submit samples for preliminary evaluation
- 10) Approval Withheld
- 11) Miscellaneous Acceptance Criteria



## WSDOT Standard Practice for HMA Mix Designs QC 8

### *Standard Practice for Development, Submittal and Approval of Hot Mix Asphalt Mix Designs*

#### 1. Scope

- 1.1 This standard specifies requirements and procedures for evaluation and approval of Hot Mix Asphalt mix designs for the Qualified Products List.
- 1.2 This standard may involve hazardous materials, operations and equipment. It does not address all of the safety problems associated with their use. It is the responsibility of whoever uses this standard to consult and establish appropriate safety and health practices and determine the applicability of regulatory limitations prior to use.

#### 2. Referenced Documents

- 2.1 WSDOT Standards
  - 2.1.1 [Standard Specifications for Road, Bridge, and Municipal Construction](#) M 41-10
  - 2.1.2 [Materials Manual](#) M 46-10

#### 3. Terminology

- 3.1 **AASHTO** – American Association of State Highway and Transportation Officials
- 3.2 **ASA** – Aggregate Source Approval
- 3.3 **ASTM** – American Society of Testing and Materials
- 3.4 **Bituminous Materials Section** – Testing Laboratory at the WSDOT State Materials Laboratory
- 3.5 **Business Days** – All weekdays, excluding state and federal holidays
- 3.6 **Contractor/Producer** – The Contractor, Producer or production facility that has the capacity for producing HMA meeting WSDOT [Standard Specifications](#).
- 3.7 **HMA** – Hot Mix Asphalt
- 3.8 **Materials Quality Assurance Section** – Office responsible for managing the Qualified Products List at the WSDOT State Materials Laboratory
- 3.9 **PG** – Performance Graded asphalt binder
- 3.10 **QPL** – Qualified Products List
- 3.11 **RAS** – Recycled Asphalt Shingles
- 3.12 **RAP** – Reclaimed Asphalt Pavement
- 3.13 **State Materials Laboratory** – 1655 S. 2nd Avenue SW, Tumwater, WA 98512-6951
- 3.14 **WSDOT** – Washington State Department of Transportation
- 3.15 **Replacement QPL Mix Design** – QPL HMA mix design that directly replaces the existing or previous QPL HMA mix design, consisting of the same class of mix, gyration level, binder grade, supplier, and aggregate source.

#### 4. Significance and Use

- 4.1 This standard specifies procedures for designing, submitting, evaluating and approving HMA mix designs for inclusion to the QPL.

#### 5. Mix Design Development

- 5.1 The Contractor/Producer or designee shall develop a HMA mix design in accordance with Section 5-04.2(1) of the *Standard Specifications*. The HMA mix design aggregate structure, asphalt binder content, anti-stripping additive, rutting susceptibility and indirect tensile strength shall be determined in accordance with WSDOT SOP 732, FOP for AASHTO T 324 and WSDOT FOP for ASTM D 6931 and meet the requirements of Sections 9-03.8(2) and 9-03.8(6) of the *Standard Specifications*.

- 5.1.1 The Contractor/Producer's mix design %Gmm Ndesign must be  $96.0 \pm 0.2\%$  at the optimum percent binder (Pb).

#### 6. Submission to the WSDOT Qualified Products List

- 6.1 Once the HMA mix design has been developed, the Contractor/Producer shall contact the Bituminous Materials Section at [HMAMD@wsdot.wa.gov](mailto:HMAMD@wsdot.wa.gov) or 360-709-5429 to initiate the HMA mix design submittal process. Replacement QPL HMA mix designs can be submitted up to six months prior to the existing QPL HMA mix design expiration date and still retain the original QPL HMA mix design date (month and day) on the new QPL HMA mix design.
- 6.2 To initiate the mix design submittal process, the Contractor/Producer shall provide the following:
- Company contact and billing information
  - A completed copy of WSDOT Form 350-042
  - A completed WSDOT Product Submittal Application Form
  - ASA Report for the aggregate source(s)
  - QPL Contractor/Producer Product Information page(s) for the PG asphalt binder and the anti-stripping additive
  - Certification on the source of the recycled materials and applicable documentation per *Standard Specifications* Sections 5-04.2 and 9-03.21(1) for mix designs containing RAP and/or RAS
  - Provide the testing and certification for toxicity characteristics in accordance with *Standard Specification* Section 9-03.21(1) for the RAS and RAP submitted with the mix design. The testing and certification shall be no older than 30 calendar days from when the mix design samples are received at the State Materials Laboratory.
- 6.3 Once the information from Step 6.2 is received the Bituminous Materials Section will assign a QPL evaluation tracking number. This will initiate the timeline associated with each step of the mix design evaluation process in Section 6 of this plan, as shown in Table 1.
- 6.4 The Bituminous Materials Section will review the mix design submittal (WSDOT Form 350-042) and all documentation provided to ensure it is complete and meets specification requirements. If the mix design submittal is complete and meets specification, the Bituminous Materials Section will prepare the initial letter with Cost estimate and email to the State Materials Laboratory Business Office. Mix design submittals that are incomplete or do not meet the specification requirements will be rejected and require resubmittal in accordance with Section 6.2 of this plan. All timelines in Table 1 will restart with resubmittal of mix designs.

- 6.5 The State Materials Laboratory Business Office will provide the following to the Contractor/ Producer:
- QPL evaluation tracking number
  - Initial letter detailing mix design evaluation
  - Cost sheet for mix design evaluation detailing submittal requirements and associated charges
  - Reimbursable Agreement and Statewide Vendor Forms (if needed)

6.6 After the contractor returns the Reimbursable Agreement and Statewide Vendor Form to the Business Office and Bituminous Materials Section, the Bituminous Materials Section will contact the Contractor/Producer to schedule the QPL HMA mix design materials delivery date.

6.6.1 The Contractor shall submit representative samples of aggregate, RAP and RAS (if required), totaling 700 pounds proportioned to match the Contractor's proposal to the State Materials Laboratory for testing.

For example, if the Contractor's proposal consists of five stockpiles with the following blending ratio:

Material	Ratio
¾" - #4	20%
½" - #8	30%
#4 - 0	30%
RAP	15%
RAS	5%

Calculate the amount of aggregate needed from each stockpile in the following manner:

Material		Pounds of Aggregate Needed Per Stockpile
¾" - #4	700 lbs x 0.20	140 pounds
½" - #8	700 lbs x 0.30	210 pounds
#4 - 0	700 lbs x 0.30	210 pounds
RAP	700 lbs x 0.15	105 pounds
RAS	700 lbs x 0.05	35 pounds

6.6.2 Transport aggregate in bags or other containers so constructed as to preclude loss or contamination of any part of the sample, or damage to the contents from mishandling during shipment. The weight limit for each bag or container of aggregate is 30 pounds maximum.

6.6.3 Each aggregate bag or container shall be clearly marked or labeled with suitable identification including the contract number, aggregate source identification and size of stockpile material.

When RAS will be used in the HMA mix design the contractor shall provide approximately 50 dried RAS samples proportioned into individual 16 to 24-ounce aluminum containers (See Pictures of acceptable container in Figure 1). The RAS samples shall be representative of the RAS stockpile being reduced per WSDOT Errata to FOP for AASHTO R 47 in the WSDOT Materials Manual. In addition to the sample identification outlined in 6.6.3, the RAS containers shall be marked with indelible markings noting the weight of the material to the 0.1 grams. The required number of tins and weights of the RAS in the containers will be given to the

contractor at the time of mix design submittal acceptance. RAS samples that do not meet the above requirements will result in rejection of the RAS mix design.

The RAS materials shall be accompanied by a test report from a certified testing laboratory verifying that the RAS materials submitted for mix design testing is non detect for asbestos utilizing Polarized Light Microscopy (PLM) 1000 point count test. The laboratory testing for asbestos content shall meet the certification requirements of Standard Specifications Section 9-03.21(1)A Reclaimed Asphalt Shingles and provide a copy of their laboratory certification along with the test results. The RAS materials shall also be accompanied by the Safety Data Sheet as outlined in Standard Specifications Section 9-03.21(1)A Recycled Asphalt Shingles.

WSDOT may independently test mix design samples for asbestos containing materials.

**Figure 1** Pictures of acceptable 16 to 24-ounce aluminum container with lid off and on



- 6.7 The Bituminous Materials Section will notify the Contractor/Producer when the mix design materials have been received, logged-in and a calendar day completion will be provided to the Contractor/Producer as specified in Section 6.9.
- 6.7.1 Mix design materials that are non-representative and/or out of specification will be rejected and require resubmittal of all mix design material. Mix design materials that are rejected and not picked up by the Contractor/Producer within 2 working days of the receipt of rejection will be disposed of. All timelines in Table 1 will restart with resubmittal of mix design materials. When WSDOT elects to independently test mix design samples for asbestos containing materials, the mix design will not be accepted until WSDOT receives the results of its independent laboratory testing.
- 6.8 A priority queue will be established by the Bituminous Materials Section for HMA mix design evaluations.
- 6.8.1 Preference will be given to mix designs submitted for WSDOT contracts.
- 6.8.2 HMA mix design evaluations for WSDOT contracts will be completed within 25 calendar days after the notification in Section 6.7.
- 6.8.3 HMA mix design evaluations that are not for WSDOT contracts, replacement HMA mix mix design evaluations containing High RAP or RAS materials, Stone Matrix Asphalt (SMA), Open Graded Friction Course (OGFC) or any other specialty asphalt mixture mix designs will be completed approximately 40 calendar days after the notification in Section 6.7.



- 6.8.4 QPL HMA mix design revisions must be submitted to the Bituminous Materials Section in writing, and if approved, a new completion date will be determined by the Bituminous Materials Section.
  - 6.8.5 The Bituminous Materials Section reserves the right to limit the number of HMA mix design evaluations accepted for non WSDOT contracts at any time. Workload and staffing will dictate the number of HMA mix design evaluations accepted at one time.
- 6.9 After the mix design evaluation is complete the Bituminous Materials Section will provide the status of the evaluation to the following:
- Final notification to the Contractor/Producer indicating QPL status after completion of the mix design evaluation.
  - Notification to the Materials Quality Assurance Section, QPL Engineer, that the evaluation is complete, and direction to add the HMA Mix Design to the QPL if applicable.

**Table 1 Timelines Associated with Each Step of the Mix Design Evaluation Process**

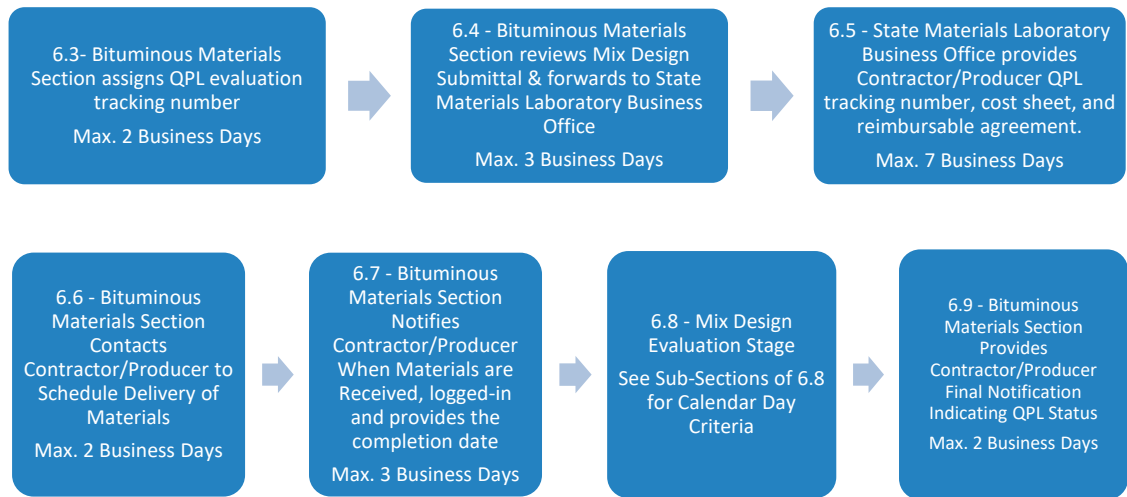

**7. Mix Design Evaluation**

- 7.1 The HMA mix design submitted by the Contractor/Producer will be evaluated by the Bituminous Materials Section in accordance with Section 9-03.8(2) and 9-03.8(6) of the *Standard Specifications*. All communication from the Bituminous Materials Section will be to the Contractor’s/Producer’s contact as specified on WSDOT Form 350-042.
- 7.2 HMA mix designs will be placed on the QPL provided they meet the requirements of Section 9-03.8(2) and 9-03.8(6) of the *Standard Specifications*.
  - 7.2.1 Voids in Mineral Aggregate (VMA) must be within 0.5% of the minimum specification in accordance with Section 9-03.8(2) of the *Standard Specifications* for the class of HMA evaluated.
  - 7.2.2 % Gmm at N design must be within 1.5% of the specification in Section 9-03.8(2) of the *Standard Specifications* for the class of HMA evaluated.
  - 7.2.3 Voids Filled with Asphalt (VFA) in Section 9-03.8(2) will not be part of the mix design evaluation.

- 7.3 A mix design that fails to meet the requirements listed in Section 7.2, 7.2.1 and 7.2.2 will not be accepted or placed on the QPL.
- 7.4 Adjustments to mix designs will not be allowed once they have been evaluated.
- 7.5 The Contractor/Producer will be issued a QPL mix design record providing the mix design is in compliance with Section 9 of this Standard Practice.
- 7.6 The QPL listing for HMA mix designs will show the following information:
- Company name
  - HMA Class
  - Aggregate Source(s)
  - PG Grade
  - PG Supplier
- Anti-stripping additive brand and quantity (if applicable)

## 8. Referencing Mix Designs From The QPL

- 8.1 Requests for reference HMA mix designs for non WSDOT projects will be completed on WSDOT Form 350-041 and emailed to [HMAMD@wsdot.wa.gov](mailto:HMAMD@wsdot.wa.gov).
- 8.2 Reference HMA mix design reports will be issued for new mix designs on active and awarded WSDOT contracts once accepted and placed on the QPL.
- 8.3 Reference HMA mix design reports will be issued for current mix designs on active and awarded WSDOT contracts provided the HMA production history is in compliance with [Standard Specifications](#) Section 5-04.3(11)F.

## 9. Removal From The QPL

- 9.1 HMA mix designs will be automatically removed from the QPL in accordance with [Standard Specifications](#) Section 5-04.2(1).
- 9.2 HMA mix designs may be removed from the QPL if found in nonconformance with the [Standard Specifications](#) or this Standard Practice. Causes for removal from the QPL may include, but are not limited to the following:
- Failure to comply with requirements of Standard Practice QC 8.
  - HMA mix designs that are out of compliance in accordance with [Standard Specifications](#)
  - Section 5-04.3(11)F.
  - Failure to notify WSDOT of changes in HMA production.
  - Removal at the request of the Contractor/Producer

## 10. Ignition Furnace Calibration Factor (IFCF) Samples

- 10.1 Each HMA mix design submitted for evaluation will have 16 IFCF samples produced for WSDOT as part of the QPL evaluation process.
- 10.2 The Contractor/Producer may elect to have 4 IFCF samples produced as part of the QPL evaluation process.



## WSDOT Standard Practice QC 9

### *Standard Practice for Approval of Recycled Materials Facilities of WSDOT Recycled Concrete and Returned Concrete*

#### 1. Scope

This standard specifies the requirements for all Recycled Materials Facilities of WSDOT recycled concrete and returned concrete. Recycled concrete aggregate (RCA) from Recycled Materials Facilities that comply with this standard will not require evaluation of LA Wear, and WSDOT Degradation Value. Certification of toxicity characteristics will be required, when requested.

This standard may involve hazardous materials, operations and equipment. It does not address all of the safety problems with their use. It is the responsibility of those using this standard to consult and establish appropriate safety and health practices and determine the applicability of regulatory limitations prior to use.

#### 2. Reference Documents

##### 2.1 WSDOT Standards

M 41-01 *Construction Manual*

M 41-10 *Standard Specifications for Road, Bridge, and Municipal Construction*

M 46-01 *Materials Manual*

#### 3. Terminology

3.1 AASHTO – American Association of State Highway and Transportation Officials

3.2 ASTM – American Society of Testing and Materials

3.3 ASA Database – The ASA (Aggregate Source Approval) is a database containing results of WSDOT preliminary testing of aggregate sources.

3.4 QC – Quality Control, the Recycled Materials Facility's activities that are performed or conducted to fulfill the contract requirements.

3.5 QPL – Washington State Department of Transportation, Qualified Products List.

3.6 RCA – Recycled concrete aggregate.

3.7 Recycled Returned Concrete – Recycled concrete aggregates that are produced from concrete returned to the plant, that was produced from a WSDOT approved aggregate source.

3.8 Returned Concrete – Concrete that was returned to the plant that was produced from a WSDOT approved aggregate source.

- 3.9 Recycled Materials Facility – The facility and location of the plant that produces recycled concrete aggregate materials.
- 3.10 WAQTC – Western Alliance for Quality Transportation Construction
- 3.11 WSDOT – Washington State Department of Transportation.
- 3.12 WSDOT Concrete – Concrete taken from WSDOT roadways and structures.
- 3.13 WSDOT Recycled Concrete – Recycled concrete aggregates that are produced from concrete taken from WSDOT roadways and structures.

#### 4. Significance and Use

This standard practice specifies processes for approving the Recycled Materials Facilities that produce/supply RCA from either returned concrete and/or WSDOT concrete. This is accomplished by a system that evaluates the QC processes of Recycled Materials Facilities and determines if these QC processes will ensure non-contaminated quality RCA. Recycled Materials Facilities that meet this standard will be listed on the QPL as an approved supplier of Tier 2 Recycled Materials for either returned concrete and/or WSDOT concrete.

#### 5. Recycled Concrete Aggregate Quality Control Plan

The Recycled Materials Facility shall have quality control plan on how the facility will ensure that returned concrete and WSDOT concrete are not blended with other recycled materials. This quality control plan should at the minimum include following;

##### 5.1 Recycled Materials Facility

###### 5.1.1 Facility Type

###### 5.1.2 Facility Address

5.1.3 Name, email address, and telephone number of the contact person responsible for the quality control of the facility.

##### 5.2 Prevention of Contamination, Segregation, and Degradation

The handling and storage of RCA shall be in such manner to minimize any segregation or degradation and to prevent contamination by foreign materials. When stockpiles of RCA cannot be stored sufficiently remote from each other to prevent mixing, baffles shall be provided which will prevent intermingling of the different stockpiles.

##### 5.3 Returned Concrete

5.3.1 Shall provide a plan on how returned concrete will be cured, stored, crushed, stockpiled, and segregated from other materials.

5.3.2 Identify what processes will be used to ensure that no contamination will occur with other materials.

5.3.3 Shall provide ASA reports for the aggregate source(s).

## 5.4 WSDOT Concrete

- 5.4.1 Shall provide a plan on how WSDOT concrete is identified, for example;
  - 5.4.1.1 Provide a contract number from WSDOT administered contract that the concrete is reclaimed from.
  - 5.4.1.2 Provide the State Route or Interstate Route along with what the concrete is from, such as;
    - 5.4.1.2.1 Cement Concrete Pavement Panel(s).
    - 5.4.1.2.2 Structure(s)
    - 5.4.1.2.3 Barrier
    - 5.4.1.2.4 Precast units
    - 5.4.1.2.5 Sidewalks
    - 5.4.1.2.6 Other application not identified here, but must be approved by the Engineer/Agency.
- 5.4.2 Shall provide a plan on how the WSDOT concrete will be stored, crushed, stockpiled, and segregated from other materials.
- 5.4.3 Identify what processes will be used to ensure that no contamination will occur with other materials.
- 5.4.4 A new quality control plan shall be required whenever changes occur that causes the existing quality control plan to become inaccurate or invalid.
- 5.4.5 In order to ensure these quality control plans are occurring, WSDOT reserves the right to visit these facilities within one day notice to ensure the Recycled Materials facility is following their approved quality control plans.

## 6. Documentation Requirements

Each Recycled Materials Facility shall provide manufacturer's certification compliance in accordance with Section 1-06.3 of the *Standard Specifications* for the RCA from either returned concrete and/or WSDOT concrete. This certification shall represent a lot of processed RCA which is a maximum of 10,000 tons. The certification shall be in English and include the following;

- 6.1 Name of Recycled Materials Facility
- 6.2 Identification of RCA, WSDOT concrete and/or Returned Concrete
  - 6.2.1 For returned concrete, include the ASA report for the aggregate source.
  - 6.2.2 For WSDOT concrete, provide the following;
    - 6.2.2.1 Contract number from where the concrete was reclaimed from or,
    - 6.2.2.2 Identify the State route or Interstate route and what item the concrete was reclaimed from.
- 6.3 List the applicable standard specification the RCA is to be used for. See table in *Standard Specifications* Section 9-03.21(1)1.

- 6.4 Quantity of RCA
- 6.5 Unique identification number traceable to the date of production, 10,000 tons maximum. Production dates of the RCA
- 6.6 A certification report shall be provided for each lot of RCA.

## 7. Revocation of Qualification

- 7.1 A Recycled Materials Facility may have its qualification status revoked and be removed from the QPL if found in non-conformance with the Standard Specification or this Standard. Causes for removal from the QPL may include, but are not limited to, the following:
  - 7.1.1 Failure to comply with the requirements of This Standard Practice.
  - 7.1.2 Failure to notify WSDOT of changes in QC plan
  - 7.1.3 Producing materials that fails to meet specification requirements.

## 8. Requalification

- 8.1 Once a Recycled Materials Facility has been removed from the QPL, the Recycled Materials Facility may request reinstatement by providing the following written information to WSDOT:
  - 8.1.1 The root cause and corrective action taken to prevent future occurrences of the problem that cause removal from the QPL.
  - 8.1.2 Updated quality control plan.
  - 8.1.3 Other information and test data as determined by WSDOT.
- 8.2 Provided there is a satisfactory resolution of the initial problem, at WSDOT's discretion the Recycled Materials Facility may either be reinstated into the QPL, or the Recycled Materials Facility may be required to reapply to the QPL. All costs of the QPL process shall be borne by the Recycled Materials Facility.



## WSDOT Standard Practice QC 10

### *Standard Practice for Approval of Recycled Materials Facilities from Stockpiles of Unknown Sources*

#### 1. Scope

This standard specifies the requirements for all Recycled Materials Stockpiles for recycled materials identified in Section 9-03.21 of the *Standard Specifications* from unknown sources. Recycled Materials Facilities that comply with this standard will require evaluation of LA Wear, Modified WSDOT Degradation test, and certification of toxicity characteristics.

This standard may involve hazardous materials, operations and equipment. It does not address all of the safety problems with their use. It is the responsibility of those using this standard to consult and establish appropriate safety and health practices and determine the applicability of regulatory limitations prior to use.

#### 2. Reference Documents

##### 2.1 AASHTO Standards

- 2.1.1 M 80 Standard Specification for Coarse Aggregate for Hydraulic Cement Concrete
- 2.1.2 R 18 Standard Recommended Practice for Establishing and Implementing a Quality Management System for Construction Materials Testing Laboratories
- 2.1.3 R 76 Reducing Samples of Aggregate to Testing Size
- 2.1.4 T 2 Standard Method of Test for Sampling of Aggregates
- 2.1.5 T 11 Standard Method of Test for Materials Finer Than 75- $\mu\text{m}$  (No. 200) Sieve in Mineral Aggregates by Washing
- 2.1.6 T 27 Standard Method of Test for Sieve Analysis of Fine and Coarse Aggregate
- 2.1.7 T 84 Standard Method of Test for Specific Gravity and Absorption of Fine Aggregate
- 2.1.8 T 85 Standard Method of Test for Specific Gravity and Absorption of Coarse Aggregate
- 2.1.9 T 96 Standard Method of Test for Resistance to Degradation of Small-Size Coarse Aggregate by Abrasion and Impact in the Los Angeles Machine
- 2.1.10 T 176 Standard Method of Test for Plastic Fines in Graded Aggregates and Soils by Use of the Sand Equivalent Test
- 2.1.11 T 304 Standard Method of Test for Uncompacted Void Content of Fine Aggregate
- 2.1.12 T 335 Standard Method of Test for Determining the Percentage of Fracture in Coarse Aggregate

## 2.2 ASTM Standards

2.2.1 D 75 Standard Practice for Sampling Aggregates

2.2.2 C 117 Standard Test Method for Materials Fine than 75- $\mu$ m (No. 200) Sieve in Mineral Aggregates by Washing

2.2.3 C 127 Standard Test Method for Relative Density (Specific Gravity) and Absorption of Coarse Aggregate

2.2.4 C 128 Standard Test Method for Relative Density (Specific Gravity) and Absorption of Fine Aggregate

2.2.5 C 131 Standard Test Method for Resistance to Degradation of Small-Size Coarse Aggregate by Abrasion and Impact in the Los Angeles Machine

2.2.6 C 136 Standard Test Method for Sieve Analysis of Fine and Coarse Aggregate

## 2.3 WAQTC Standards

2.3.1 FOP for AASHTO T 2, Sampling Aggregates

2.3.2 FOP for AASHTO T 27\_T11, Sieve Analysis of Fine and Coarse Aggregate

2.3.3 FOP for AASHTO R 76, Reducing Samples of Aggregates to Testing Size

2.3.4 FOP for AASHTO T 85, Specific Gravity and Absorption of Coarse Aggregate

2.3.5 FOP for AASHTO T 176, Plastic Fines in Graded Aggregates and Soils by Use of the Sand Equivalent Test

2.3.6 FOP for AASHTO T 335, Determining the Percentage of Fracture in Coarse Aggregate

## 2.4 WSDOT Standards

2.4.1 M 41-01 *Construction Manual*

2.4.2 M 41-10 *Standard Specifications for Road, Bridge, and Municipal Construction*

2.4.3 M 46-01 *Materials Manual*

2.4.4 WSDOT Test Method T 113 Method of Test for Determination of Degradation Value

2.4.5 WSDOT Test Method T 304 FOP for Uncompacted Void Content of Fine Aggregate

2.4.6 WSDOT QC 3 Quality System Laboratory Review

## 3. Terminology

3.1 AASHTO – American Association of State Highway and Transportation Officials

3.2 ACI – American Concrete Institute

3.3 ASTM – American Society of Testing and Materials

3.4 ASA Database – The ASA (Aggregate Source Approval) is a database containing results of WSDOT preliminary testing of aggregate sources

3.5 Modified Degradation Test- WSDOT Test Method T 113 run with  $\frac{1}{2}$  -  $\frac{3}{8}$  inch and  $\frac{3}{8}$  -  $\frac{1}{4}$  inch portions in step g and replacing the  $\frac{1}{4}$  - #10 portion with  $\frac{1}{4}$  - #4 material of the Recycled Concrete Aggregate



- 3.6 Stockpiles – stockpiles that are composed recycled concrete from which aggregate sources are unknown
- 3.7 QC – Quality Control, the Recycled Materials Facility’s operational techniques and activities that are performed or conducted to fulfill specification compliance
- 3.8 QCP – Quality Control Plan
- 3.9 QPL – Washington State Department of Transportation, Qualified Products List
- 3.10 Recycling Materials Facility – The facility and location of the plant that produces recycled materials
- 3.11 WAQTC – Western Alliance for Quality Transportation Construction
- 3.12 WSDOT – Washington State Department of Transportation

#### 4. Significance and Use

This standard practice specifies processes for approving Recycling Materials Facilities. This is accomplished by a system that evaluates the quality control processes of Recycling Materials Facilities and determines if these quality control processes will ensure that non- contaminated quality materials are produced to meet the specified materials quality.

#### 5. Recycled Materials Quality Control Plan

The Recycling Materials Facility shall have QCP on how the facility will ensure that required quality levels are obtained. This QCP should at the minimum include following;

##### 5.1 Recycling Materials Facility

###### 5.1.1 Facility Type

###### 5.1.2 Facility Address

5.1.3 Name, email address, and telephone number of the contact person responsible for the quality control of the facility.

##### 5.2 Prevention of Contamination, Segregation, and Degradation

The handling and storage of recycled materials shall be in such manner to minimize any segregation or degradation and to prevent contamination by foreign materials or deleterious materials in accordance with Section 9-03 of the *Standard Specifications*.

5.2.1 Identify what processes will be used to ensure that no contamination will occur with other materials.

5.2.2 A new QCP shall be required whenever changes occur that causes the existing QCP to become inaccurate or invalid.

5.2.3 In order to ensure these quality control plans are occurring, WSDOT reserves the right to visit these facilities with a one day notice to ensure the Recycling Materials facility is following their approved quality control plans and perform sampling and testing.

5.3 Testing Requirements

5.3.1 Each Recycling Materials Facility must designate either its own personal or a commercial laboratory for the performance of QC testing. QC testing facility and personnel performing test for submittal to WSDOT must be equipped to run all applicable tests with equipment and technicians meeting the following requirements:

5.3.1.1 Materials testers shall be either WAQTC certified Aggregate Testing Technicians (AgTT) or ACI Aggregate Testing Technician level 1 and 2, as appropriate.

5.3.1.2 The QC laboratory and testing equipment shall be compliant with WSDOT QC 3 “Standard Practice for Quality System Laboratory Review” or hold a current AASHTO Accreditation with a scope of Aggregates.

5.3.2 Documentation of personnel qualifications and the equipment certification/standardization/checked records shall be maintained and available for inspection.

5.4 Analysis and Recording of Data

5.4.1 The QCP shall include a procedure that will review and analyze test data, so as to effectively evaluate control of the process.

5.4.2 The producer shall monitor its own data for compliance with the current Washington State Department of Transportation *Standard Specifications*. When there is an indication that the process is not being adequately controlled in compliance with the QCP, the producer shall immediately take the necessary steps to adjust the process

5.5 QC Tests

The maximum QC testing frequency is shown in Table 1:

**Table 1** Minimum Quality Control testing

<b>All Aggregates per Standard Specification 9-03</b>	
<b>Test</b>	<b>Frequency</b>
Toxicity per 9-03.21(1)	Once every 90 days
Modified Degradation	Once every 3 Months
SPG	Once every 3 Months
Absorption	Once every 3 Months
LA wear	Once every 3 Months
Gradation	Once every 10,000 tons
SE	Once every 10,000 tons
Dust Ratio	Once every 10,000 tons

The QCP may utilize other testing frequencies, but shall not exceed the frequencies shown in Table 1.

## 6. Documentation Requirements

A manufacturer's certification compliance in accordance with Section 1-06.3 of the WSDOT *Standard Specifications* shall be provide to Project Engineer. This certification shall represent a lot of processed recycled materials, not to exceed the frequencies shown in Table 1. The manufacture's certification of compliance shall be in English and include the following;

- 6.1 Name of Recycling Materials Facility
- 6.2 WSDOT Standard Specification that the recycled aggregate meets
- 6.3 Quantity of recycled material
- 6.4 Identify the percentage(s) of recycled materials and natural aggregate in the final blended aggregate product
- 6.5 Unique identification number traceable to the production dates of the recycled materials
- 6.6 Certification shall be provided for each lot of recycled materials, with the maximum lot size not exceeding 10,000 tons
- 6.7 Copy of test reports for items listed in Table 1 for each lot , including most current toxicity test, Modified WSDOT Degradation, LA wear test, Specific Gravity and Absorption results

## 7. Revocation of Qualifications

- 7.1 A Recycling Materials Facility may have its qualification status revoked and be removed from the QPL if found in non-conformance with the Standard Specification or this Standard. Causes for removal from the QPL may include, but are not limited to, the following;
  - 7.1.1 Failure to comply with the requirements of this Standard Practice
  - 7.1.2 Failure to notify WSDOT of changes in QC plan
  - 7.1.3 Producing materials that fails to meet specification requirements

## 8. Requalification

- 8.1 Once a Recycling Materials Facility has been removed from the QPL, the Recycling Materials Facility may request reinstatement by providing the following written information to WSDOT:
  - 8.1.1 The root cause and corrective action taken to prevent future occurrences of the problem that cause removal from the QPL
  - 8.1.2 Updated QCP
  - 8.1.3 Other information and test data as determined by WSDOT
- 8.2 Provided there is a satisfactory resolution of the initial problem, at WSDOT's discretion, the Recycling Materials Facility may either be reinstated into the QPL, or the Recycling Materials Facility may be required to reapply to the QPL. All costs of the QPL process shall be borne by the Recycling Materials Facility.



# WSDOT Standard Practice QC 11

*Vacant*



This page intentionally left blank.

# WSDOT Standard Practice QC 12 (ASA)

## Standard Practice for Evaluation of Aggregate Sources

### 1. Scope

The standard specifies procedures for approval of aggregate sources. This standard may involve hazardous, operations and equipment. It does not address all of the safety problems associated with their use. It is the responsibility of those using this standard to consult and establish appropriate safety and health practices and determine the applicability of regulatory limitations prior to use.

### 2. Referenced Documents

#### 2.1 WSDOT Standards

2.1.1 *Standard Specifications for Road, Bridge, and Municipal Construction* M 41-10

### 3. Terminology

AASHTO – American Association of State Highway and Transportation Officials

ASA – Aggregate Source Approval database

WSDOT – The Washington State Department of Transportation

### 4. Significance and Use

This standard specifies procedures for approval of aggregate sources.

### 5. Sources requesting Aggregate Source Approval (ASA) evaluation

#### 5.1 Process Initiation and Payment.

5.1.1 To initiate submittal process contact the ASA Engineer by email at [ASA@WSDOT.WA.GOV](mailto:ASA@WSDOT.WA.GOV) or by phone at 360-709-5442.

5.1.2 Once the Letter and Scope of Work Budget Estimate is received, the requestor is required to contact the State Materials Lab Business section to establish a “Statewide Vendor Number” and sign the “Reimbursable Agreement for State Materials Lab Materials Evaluation Program” contract. Sampling and testing cannot occur until these documents are submitted to the State Materials Lab Business Section and approved.

5.1.3 Invoices will be generated and sent to the requestor during the evaluation. Once receiving an invoice, you are required to pay the full invoice amount.

5.1.4 Once the invoice is received, online payments by credit card can be made by WSDOT’s Materials Evaluation Program (MEP), which is accessible via Secure Access Washington (SAW) at <https://secureaccess.wa.gov>. For online payment instructions, please visit: <https://wsdot.wa.gov/engineering-standards/construction-materials/materials-evaluation-program>.

5.1.5 Payments by Check: please send your payment for the invoice that was sent to you to: Washington State Department of Transportation, ATTN: Cashier, WSDOT - State Materials Laboratory - ASA2021###, Invoice Number #####, PO Box 47305, Olympia, WA 98504.

5.1.6 The "Statewide Vendor Number" and the signed "Reimbursable Agreement for State Materials Lab Materials Evaluation Program" is received and processed by the WSDOT Materials Laboratory Business Section.

## 5.2 Sampling and Testing

5.2.1 Once the signed Reimbursable Agreement is accepted and the Work Order created, the Department will sample and test the stockpile of materials. A minimum 10-ton stockpile of materials is required, and the sampling will be done in accordance with WSDOT SOP 128 Sampling for Aggregate Source Approval.

5.2.2 Sample will be transported to the State Materials Laboratory for testing.

5.2.3 The Aggregate source shall contact the ASA Engineer at the Materials Quality Assurance (MQA) Section, State Materials Laboratory, to make a request to be resampled on the interval established by the Department, up to a maximum interval of five years.

## 5.3 Reporting

5.3.1 Once testing has concluded, the results will be posted on the ASA website and a final letter with a copy of the ASA report will be sent to the requestor.

## 5.4 Suspension of Source Approval:

5.4.1 The sources listing on the ASA will be suspended, if:

- The Department tests do not indicate compliance with *Standard Specifications* Section 9-03.
- The aggregate source does not make payment for renewal sampling at testing.



## SAMPLING FRESHLY MIXED CONCRETE WAQTC TM 2

### Scope

This practice covers procedures for obtaining representative samples of fresh concrete delivered to the project site. The practice includes sampling from stationary, paving and truck mixers, and from agitating and non-agitating equipment used to transport central mixed concrete.

This practice also covers the removal of large aggregate particles by wet sieving.

Sampling concrete may involve hazardous materials, operations, and equipment. This standard does not purport to address all of the safety problems associated with its use. It is the responsibility of the user of this standard to establish appropriate safety and health practices.

**Warning**—Fresh Hydraulic cementitious mixtures are caustic and may cause chemical burns to skin and tissue upon prolonged exposure.

### Apparatus

- Receptacle: wheelbarrow, bucket or other suitable container that does not alter the properties of the material being sampled
- Sample cover (plastic, canvas, or burlap)
- Shovel
- Cleaning equipment, including scrub brush, rubber gloves, water
- Apparatus for wet sieving, including: a sieve(s), meeting the requirements of FOP for AASHTO T 27/T 11, minimum of 2 ft<sup>2</sup> (0.19 m<sup>2</sup>) of sieving area, conveniently arranged and supported so that the sieve can be shaken rapidly by hand.

### Procedure

1. Use every precaution in order to obtain samples representative of the true nature and condition of the concrete being placed being careful not to obtain samples from the very first or very last portions of the batch. The size of the sample will be 1.5 times the volume of concrete required for the specified testing, but not less than 0.03 m<sup>3</sup> (1 ft<sup>3</sup>).
2. Dampen the surface of the receptacle just before sampling, empty any excess water.

**Note 1:** Sampling should normally be performed as the concrete is delivered from the mixer to the conveying vehicle used to transport the concrete to the forms; however, specifications may require other points of sampling, such as at the discharge of a concrete pump.

3. Use one of the following methods to obtain the sample:
  - **Sampling from stationary mixers**

Obtain the sample after a minimum of  $1/2 \text{ m}^3$  ( $1/2 \text{ yd}^3$ ) of concrete has been discharged. Perform sampling by passing a receptacle completely through the discharge stream, or by completely diverting the discharge into a receptacle. Take care not to restrict the flow of concrete from the mixer, container, or transportation unit so as to cause segregation. These requirements apply to both tilting and non-tilting mixers.
  - **Sampling from paving mixers**

Obtain the sample after the contents of the paving mixer have been discharged. Obtain increments from at least five different locations in the pile and combine into one test sample. Avoid contamination with subgrade material or prolonged contact with absorptive subgrade. To preclude contamination or absorption by the subgrade, the concrete may be sampled by placing a shallow container on the subgrade and discharging the concrete across the container.
  - **Sampling from revolving drum truck mixers or agitators**

Obtain the sample after a minimum of  $1/2 \text{ m}^3$  ( $1/2 \text{ yd}^3$ ) of concrete has been discharged. Obtain sample after all of the water has been added to the mixer. Do not obtain sample from the very first or last portions of the batch discharge. Perform sampling by repeatedly passing a receptacle through the entire discharge stream or by completely diverting the discharge into a receptacle. Regulate the rate of discharge of the batch by the rate of revolution of the drum and not by the size of the gate opening.
  - **Sampling from open-top truck mixers, agitators, non-agitating equipment, or other types of open-top containers**

Obtain the sample by whichever of the procedures described above is most applicable under the given conditions.
  - **Sampling from pump or conveyor placement systems**

Obtain sample after a minimum of  $1/2 \text{ m}^3$  ( $1/2 \text{ yd}^3$ ) of concrete has been discharged. Obtain sample after all of the pump slurry has been eliminated. Perform sampling by repeatedly passing a receptacle through the entire discharge system or by completely diverting the discharge into a receptacle. Do not lower the pump arm from the placement position to ground level for ease of sampling, as it may modify the air content of the concrete being sampled. Do not obtain samples from the very first or last portions of the batch discharge.
4. Transport sample to the testing location.
5. Combine sample or increments and remix with a shovel the minimum amount necessary to ensure uniformity. Protect the sample from direct sunlight, wind, rain, and sources of contamination.

6. Complete test for temperature and start tests for slump and air content within 5 minutes of obtaining the sample. Start molding specimens for strength tests within 15 minutes of obtaining the sample. Complete the test methods as expeditiously as possible.

### **Wet Sieving**

When required due to oversize aggregate, the concrete sample shall be wet sieved, after transporting but prior to remixing, for slump testing, air content testing or molding test specimens, by the following:

1. Place the sieve designated by the test procedure over the dampened receptacle.
2. Pass the concrete over the designated sieve. Do not overload the sieve (one particle thick).
3. Shake or vibrate the sieve until no more material passes the sieve. A horizontal back and forth motion is preferred.
4. Discard oversize material including all adherent mortar.
5. Repeat until sample of sufficient size is obtained. Mortar adhering to the wet-sieving equipment shall be included with the sample.
6. Using a shovel, remix the sample the minimum amount necessary to ensure uniformity.

*Note 2:* Wet sieving is not allowed for samples being used for density determinations according to the FOP for AASHTO T 121.

### **Report**

- On forms approved by the agency
- Sample ID
- Date
- Time
- Location
- Quantity represented

CONCRETE

WAQTC

WAQTC TM 2 (21)

**PERFORMANCE EXAM CHECKLIST**

**SAMPLING FRESHLY MIXED CONCRETE  
WAQTC TM 2**

**Participant Name** \_\_\_\_\_ **Exam Date** \_\_\_\_\_

**Record the symbols “P” for passing or “F” for failing on each step of the checklist.**

<b>Procedure Element</b>	<b>Trial 1</b>	<b>Trial 2</b>
1. Receptacle dampened and excess water removed?	_____	_____
2. Obtain a representative sample from stationary mixer:		
a. Concrete sampled after 1/2 m <sup>3</sup> (1/2 yd <sup>3</sup> ) discharged?	_____	_____
b. Receptacle passed through entire discharge stream or discharge stream completely diverted into sampling container?	_____	_____
3. Obtain a representative sample from revolving drum truck mixer or agitator:		
a. Concrete sampled after 1/2 m <sup>3</sup> (1/2 yd <sup>3</sup> ) discharged?	_____	_____
b. Receptacle passed through entire discharge stream or discharge stream completely diverted into sampling container?	_____	_____
4. Obtain a representative sample from a paving mixer:		
a. Concrete sampled after all the concrete has been discharged?	_____	_____
b. Material obtained from at least 5 different locations in the pile?	_____	_____
c. Avoid contaminating the sample with sub-grade materials.	_____	_____
5. Obtain a representative sample from a pump:		
a. Concrete sampled after 1/2 m <sup>3</sup> (1/2 yd <sup>3</sup> ) has been discharged?	_____	_____
b. All the pump slurry is out of the lines?	_____	_____
c. Receptacle passed through entire discharge stream or discharge stream completely diverted into sampling container?	_____	_____
d. Do not lower the pump arm from the placement position.	_____	_____
6. Sample transported to place of testing?	_____	_____
7. Sample remixed?	_____	_____
8. Protect sample against rapid evaporation and contamination?	_____	_____
9. Minimum size of sample 0.03 m <sup>3</sup> (1ft <sup>3</sup> )?	_____	_____
10. Completed temperature test within 5 minutes of obtaining sample?	_____	_____

**OVER**

CONCRETE

WAQTC

WAQTC TM 2 (24)

**Procedure Element**

**Trial 1 Trial 2**

11. Start tests for slump and air within 5 minutes of obtaining sample?

\_\_\_\_\_

\_\_\_\_\_

12. Start molding cylinders within 15 minutes of obtaining sample?

\_\_\_\_\_

\_\_\_\_\_

13. Wet Sieving:

a. Required sieve size determined for test method to be performed?

\_\_\_\_\_

\_\_\_\_\_

b. Concrete placed on sieve and doesn't overload the sieve?

\_\_\_\_\_

\_\_\_\_\_

c. Sieve shaken until no more material passes the sieve?

\_\_\_\_\_

\_\_\_\_\_

d. Oversized aggregate discarded?

\_\_\_\_\_

\_\_\_\_\_

e. Sieving continued until required testing size obtained?

\_\_\_\_\_

\_\_\_\_\_

f. Sample remixed?

\_\_\_\_\_

\_\_\_\_\_

Comments: First attempt: Pass\_\_\_\_\_Fail\_\_\_\_\_ Second attempt: Pass\_\_\_\_\_Fail\_\_\_\_\_

\_\_\_\_\_  
\_\_\_\_\_  
\_\_\_\_\_

Examiner Signature \_\_\_\_\_ WAQTC #: \_\_\_\_\_

This checklist is derived, in part, from copyrighted material printed in ACI CP-1, published by the American Concrete Institute.

**PERFORMANCE EXAM CHECKLIST (ORAL)**

**SAMPLING FRESHLY MIXED CONCRETE  
WAQTC TM 2**

**Participant Name** \_\_\_\_\_ **Exam Date** \_\_\_\_\_

Record the symbols “P” for passing or “F” for failing on each step of the checklist.

Procedure Element	Trial 1	Trial 2
1. What is the minimum sample size? a. 0.03 m <sup>3</sup> or 1 ft <sup>3</sup>	_____	_____
2. Describe the surface of the receptacle before the sample is introduced into it? a. It must be dampened.	_____	_____
3. Describe how to obtain a representative sample from a stationary mixer. a. Sample the concrete after 1/2 m <sup>3</sup> (1/2 yd <sup>3</sup> ) has been discharged. a. Pass receptacle through entire discharge stream or completely divert discharge stream into sampling container.	_____	_____
4. Describe how to obtain a representative sample from a paving mixer. a. Sample the concrete after all the concrete has been discharged. b. Obtain the increments from at least 5 different locations in the pile. c. Avoid contaminating the sample with sub-grade materials.	_____	_____
5. Describe how to obtain a representative sample from a revolving drum truck mixer or agitator. a. Sample the concrete after 1/2 m <sup>3</sup> (1/2 yd <sup>3</sup> ) has been discharged. b. Pass receptacle through entire discharge stream or completely divert discharge stream into sampling container.	_____	_____
6. Describe how to obtain a representative sample from a pump: a. Sample the concrete after 1/2 m <sup>3</sup> (1/2 yd <sup>3</sup> ) has been discharged. b. Make sure all the pump slurry is out of the lines. c. Pass receptacle through entire discharge stream or completely divert discharge stream into sampling container. d. Do not lower the pump arm from the placement position.	_____	_____
7. After obtaining the sample what must you do? a. Transport to place of testing.	_____	_____

**OVER**

CONCRETE

WAQTC

WAQTC TM 2 (24)

**Procedure Element**

**Trial 1 Trial 2**

- 8. What must be done with the sample once you have transported them to the place of testing?
  - a. Combine and remix the sample. \_\_\_\_\_
  - b. Protect sample against rapid evaporation and contamination. \_\_\_\_\_
- 9. What are the two time parameters associated with sampling?
  - a. Complete temperature test and start tests for slump and air within 5 minutes of sample being obtained? \_\_\_\_\_
  - b. Start molding cylinders within 15 minutes of sample being obtained? \_\_\_\_\_
- 10. What test methods may require wet sieving?
  - a. Slump, air content, and strength specimens? \_\_\_\_\_
- 11. The sieve size used for wet sieving is based on?
  - a. The test method to be performed. \_\_\_\_\_
- 12. What is done with the oversized aggregate?
  - a. Discard it. \_\_\_\_\_
- 13. How long must you continue wet sieving?
  - a. Until a sample of sufficient size for the test being performed is obtained. \_\_\_\_\_
- 14. What must be done to the sieved sample before testing?
  - a. Remix. \_\_\_\_\_

Comments: First attempt: Pass\_\_\_\_\_Fail\_\_\_\_\_ Second attempt: Pass\_\_\_\_\_Fail\_\_\_\_\_

---



---



---



---



---



---



---

Examiner Signature \_\_\_\_\_ WAQTC #: \_\_\_\_\_

This checklist is derived, in part, from copyrighted material printed in ACI CP-1, published by the American Concrete Institute.



## VOLUMETRIC PROPERTIES OF ASPHALT MIXTURES WAQTC TM 13

### Scope

This procedure covers the determination of volumetric properties of plant produced asphalt mixtures, i.e., air voids ( $V_a$ ), voids in mineral aggregate (VMA), voids filled with asphalt binder (VFA), effective asphalt binder content ( $P_{be}$ ) and Dust to Binder Ratio ( $P_{\#200}/P_{be}$ ). The in-production volumetric properties are then compared to agency specifications.

### Definition of Terms

- $G_{mm}$  = theoretical maximum specific gravity (Gravity<sub>mix max</sub>)
- $G_{mb}$  = measured bulk specific gravity (Gravity<sub>mix bulk</sub>)
- $G_{sb}$  = oven-dry bulk specific gravity of aggregate (Gravity<sub>stone bulk</sub>)
- $G_{sa}$  = apparent specific gravity of aggregate (Gravity<sub>stone apparent</sub>)
- $G_{sc}$  = effective specific gravity of aggregate (Gravity<sub>stone effective</sub>)
- $G_b$  = specific gravity of the binder (Gravity<sub>binder</sub>)
- $V_a$  = air Voids (Voids<sub>air</sub>)
- VMA = Voids in Mineral Aggregate
- VFA = Voids Filled with Asphalt (binder)
- $V_{ba}$  = absorbed binder volume (Voids<sub>binder absorbed</sub>)
- $V_{be}$  = effective binder volume (Voids<sub>binder effective</sub>)
- $P_b$  = percent binder content (Percent<sub>binder</sub>)
- $P_{ba}$  = percent absorbed binder (Percent<sub>binder absorbed</sub>)
- $P_{be}$  = percent effective binder content (Percent<sub>binder effective</sub>)
- $P_s$  = percent of aggregate (Percent<sub>stone</sub>)
- DP = Dust proportion to effective binder ratio  
( $P_{\#200}/P_{be}$ )

**Background**

Whether a mix design is developed through a Marshall, Hveem, or Superpave mix design process there are basic volumetric requirements of all. Volumetric properties are the properties of a defined material contained in a known volume. Asphalt mixture volumetric properties can include bulk specific gravity, theoretical maximum specific gravity, air voids, and voids in mineral aggregate.

Many agencies specify values of the volumetric properties to ensure optimum performance of the pavement. The asphalt mixture must be designed to meet these criteria. In production the asphalt mixture is evaluated to determine if the mix still meets the specifications and is consistent with the original mix design (JMF). The production asphalt mixture may vary from the mix design and may need to be modified to meet the specified volumetric criteria.

To compare the in-production volumetric properties to agency specifications and the JMF a sample of loose asphalt mixture mix is obtained in accordance with FOP for AASHTO R 97. The sample is then compacted in a gyratory compactor to simulate the in-place asphalt mixture pavement after it has been placed, compacted, and endured several years of traffic. The volumetric properties of the compacted specimen are determined.

**Asphalt mixture phase diagram**

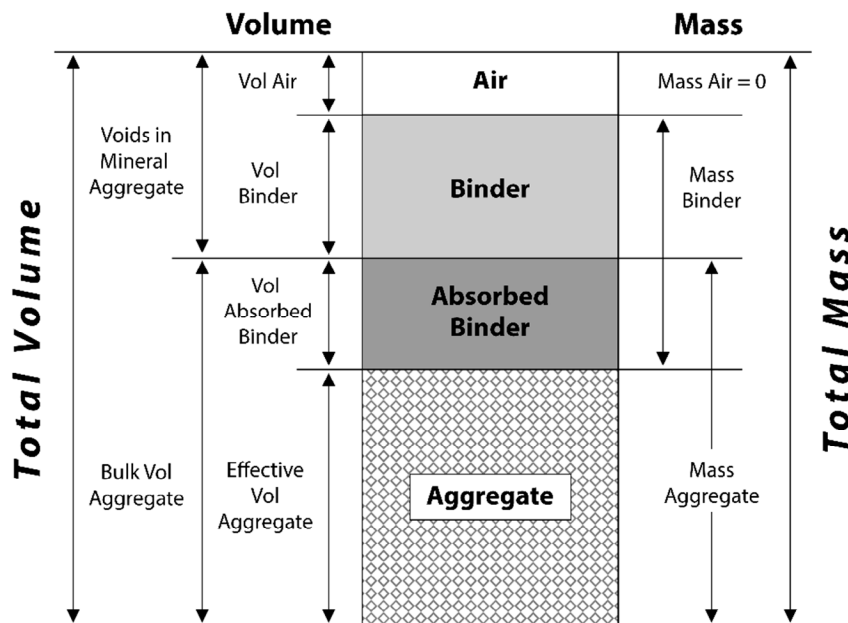

Each of the properties in the asphalt mixture phase diagram can be measured or calculated. For example: The mass of the aggregate is measured; the voids in mineral aggregate (VMA) is calculated; total asphalt binder can be measured but the amount available to act as an effective binder in the mix must be calculated because it is the quantity left after the aggregate has absorbed some of the asphalt binder.

The volumetric proportions of the asphalt binder and aggregate components of an asphalt mixture and their relationship to the other components are considered. The mass of the components and their specific gravities are used to determine the volumes of each of the components in the mix. The volumetric properties of a compacted asphalt mixture: air voids ( $V_a$ ), voids in mineral aggregate (VMA), voids filled with asphalt binder (VFA), and effective asphalt binder content ( $P_{be}$ ) provide some indication of the mixture’s probable performance.

**Volumetric Properties**

**Volumetric Relationship of Asphalt Mixture Constituents**

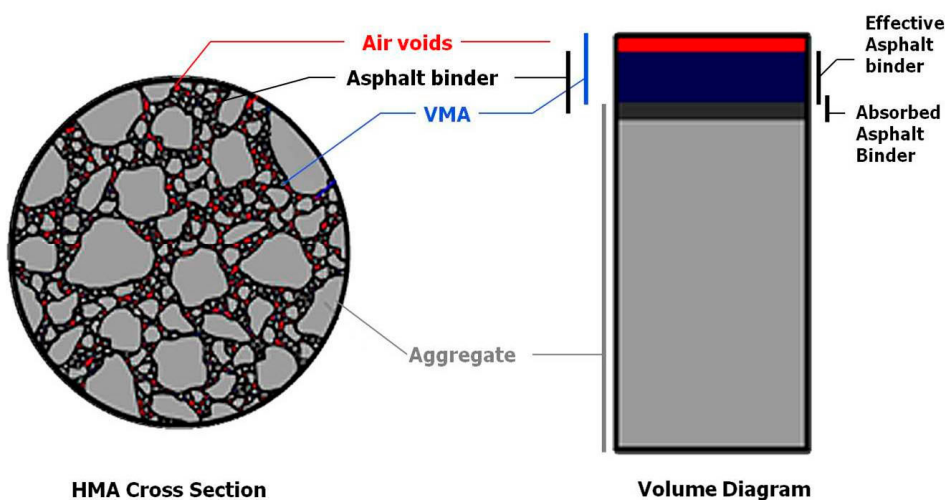

**Required Values**

The specific gravities listed in Table 1 and the percent by mass of each of the components in the asphalt mixture are needed to determine the volumetric properties. Other values required are also listed. Some of these values are obtained from the JMF and some are measured from a plant produced asphalt mixture sample.

**Table 1**

<b>Data</b>	<b>Test Method</b>	<b>Obtained</b>
G <sub>sb</sub> - combined aggregate bulk specific gravity	AASHTO T 84 / T 85 or agency approved test method	JMF or performed at the beginning of placement
G <sub>b</sub> – measured specific gravity of the asphalt binder	AASHTO T 228	JMF or from the supplier
G <sub>mm</sub> – measured maximum specific gravity of the loose mix	FOP for AASHTO T 209	Performed on the field test sample
G <sub>mb</sub> – measured bulk specific gravity of the compacted paving mix	FOP for AASHTO T 166	Performed on the field compacted specimen
P <sub>b</sub> – percent asphalt binder	FOP for AASHTO T 308	Performed on the field test sample
P-#200 – aggregate passing the #200 (75 µm) sieve	FOP for AASHTO T 30	Performed on the field test sample

### Air Voids (V<sub>a</sub>)

Air voids are the total volume of the small pockets of air between the coated aggregate particles throughout a compacted paving mixture. Appropriate air voids contribute to the stability of the asphalt mixture and help the pavement withstand the combined action of environment and traffic loads. The designated percent air voids allows for thermal expansion of the asphalt binder and contributes a cushion for future compaction. Air voids are expressed as a percent of the bulk volume of the compacted mixture (G<sub>mb</sub>) when compared to the maximum specific gravity (G<sub>mm</sub>).

$$V_a = 100 \left[ \frac{(G_{mm} - G_{mb})}{G_{mm}} \right]$$

Where:

V<sub>a</sub> = air voids in compacted mixture, percent of total volume (report to 0.1)

G<sub>mm</sub> = maximum specific gravity of paving mixture (AASHTO T 209)

G<sub>mb</sub> = bulk specific gravity of compacted mixture (AASHTO T 166)

### Percent Aggregate (Stone) ( $P_s$ )

$P_s$  is the percent aggregate (stone) content, expressed as a percentage of the total mass of the sample.

$$P_s = 100 - P_b$$

Where:

- $P_s$  = percent aggregate (stone) percent by total weight  
 $P_b$  = asphalt binder content (AASHTO T 308)

### Voids in the Mineral Aggregate (VMA)

VMA is the volume of intergranular void space between the aggregate particles of the compacted paving mixture that includes the air voids and the effective binder content, expressed as a percent of the total volume of the sample.

$$VMA = 100 - \left[ \frac{(G_{mb} \times P_s)}{G_{sb}} \right]$$

Where:

- VMA = voids in mineral aggregate, percent of bulk volume (report to 0.1)  
 $G_{sb}$  = bulk specific gravity of combined aggregate (AASHTO T 85 / T 84 or agency approved method from Job Mix Formula)  
 $G_{mb}$  = bulk specific gravity of compacted mixture (AASHTO T 166)  
 $P_s$  = aggregate content, percent by total weight =  $100 - P_b$   
 $P_b$  = asphalt binder content (AASHTO T 308) percent by total weight

### Voids Filled with Asphalt (binder) (VFA)

VFA is the volume of space between the aggregate particles of the compacted paving mixture filled with asphalt binder, expressed as a percent of the total volume of the sample. The VFA increases as the asphalt binder content increases as it is the percent of voids that are filled with asphalt which doesn't include the absorbed asphalt.

$$VFA = 100 \left[ \frac{(VMA - V_a)}{VMA} \right]$$

Where:

- VFA = voids filled with asphalt, percent of VMA (report to 1)  
VMA = voids in mineral aggregate, percent of bulk volume  
 $V_a$  = air voids in compacted mixture, percent of total volume.

### Effective Specific Gravity of the Aggregate (Stone) ( $G_{se}$ )

The  $G_{se}$  is used to quantify the asphalt binder absorbed into the aggregate particle. This is a calculated value based on the specific gravity of the mixture,  $G_{mm}$ , and the specific gravity of the asphalt binder,  $G_b$ . This measurement includes the volume of the aggregate particle plus the void volume that becomes filled with water during the test soak period minus the volume of the voids that absorb asphalt binder. Effective specific gravity lies between apparent and bulk specific gravity.

$G_{se}$  is formally defined as the ratio of the mass in air of a unit volume of a permeable material (excluding voids permeable to asphalt binder) at a stated temperature to the mass in air (of equal density) of an equal volume of gas-free distilled water at a stated temperature.

$$G_{se} = \frac{P_s}{\left[ \left( \frac{100}{G_{mm}} \right) - \left( \frac{P_b}{G_b} \right) \right]}$$

Where:

- $G_{se}$  = effective specific gravity of combined aggregate (report to 0.001)
- $P_s$  = aggregate content, percent by total weight = 100 –  $P_b$
- $G_{mm}$  = maximum specific gravity of mix (AASHTO T 209)
- $P_b$  = asphalt binder content (AASHTO T 308) percent by total weight
- $G_b$  = specific gravity of asphalt binder (JMF or asphalt binder supplier)

### Percent of Absorbed (asphalt) Binder ( $P_{ba}$ )

$P_{ba}$  is the total percent of the asphalt binder that is absorbed into the aggregate, expressed as a percentage of the mass of aggregate rather than as a percentage of the total mass of the mixture. This portion of the asphalt binder content does not contribute to the performance of the mix.

$$P_{ba} = 100 \left[ \frac{(G_{se} - G_{sb})}{(G_{sb} \times G_{se})} \right] G_b$$

Where:

- $P_{ba}$  = absorbed asphalt binder (report to 0.01) percent of aggregate
- $G_{se}$  = effective specific gravity of combined aggregate
- $G_{sb}$  = bulk specific gravity of combined aggregate (AASHTO T 85 / T 84 or agency approved method from Job Mix Formula)
- $G_b$  = specific gravity of asphalt binder (JMF or asphalt binder supplier)

### Percent of Effective (asphalt) Binder ( $P_{be}$ )

$P_{be}$  is the total asphalt binder content of a paving mixture minus the portion of asphalt binder that is lost by absorption into the aggregate particles, expressed as a percentage of the mass of aggregate. It is the portion of the asphalt binder content that remains as a coating on the outside of the aggregate particles. This is the asphalt content that controls the performance of the mix.

$$P_{be} = P_b - \left[ \frac{P_{ba}}{100} \times P_s \right]$$

Where:

$P_{be}$  = effective asphalt binder content (report to 0.01), percent by total weight

$P_s$  = aggregate content, percent by total weight = 100 –  $P_b$

$P_b$  = asphalt binder content (AASHTO T 308) percent by total weight

$P_{ba}$  = absorbed asphalt binder

### Dust Proportion – DP (Dust to Effective (asphalt) Binder Ratio)

The DP is the percent passing the No. 200 sieve of the gradation divided by the percent of effective asphalt binder. Excessive dust reduces asphalt binder film thickness on the aggregate which reduces the durability. Insufficient dust may allow excessive asphalt binder film thickness, which may result in a tender, unstable mix.

$$DP = \frac{P_{-#200}}{P_{be}}$$

Where:

DP = Dust Proportion, (dust-to-binder ratio) (report to 0.01)

$P_{-#200}$  = aggregate passing the -#200 (75  $\mu$ m) sieve, percent by mass of aggregate (AASHTO T 30)

$P_{be}$  = effective asphalt binder content, percent by total weight

## Mix Design and Production Values

### Job Mix Formula

Table 2 includes example data required from the JMF. Some of these values are used in the example calculations.

*Note:* Some of the targets may change after the asphalt mixture is in production based on field test data.

**Table 2**

<b>JMF Data</b>	
Asphalt binder grade	PG 64-28
$N_{\text{values}}$	$N_{\text{ini}} = 7$ <b><math>N_{\text{des}} = 75</math></b> $N_{\text{max}} = 115$
$G_{\text{sb}}$ (combined specific gravity of the aggregate)	2.678
Target $P_b$	4.75%
Initial sample mass for gyratory specimens	4840 grams
Mixing temperature range	306 – 312 °F
Laboratory compaction temperature range	286 – 294 °F
$G_b$ (specific gravity of the asphalt binder)	1.020
<b>Target gradation</b>	
Sieve Size mm (in.)	Percent Passing
19.0 (3/4)	100
12.5 (1/2)	85
9.5 (3/8)	80
4.75 (No. 4)	50
2.36 (No. 8)	30
0.1.18 (No. 16)	25
0.600 (No. 30)	15
0.300 (No. 50)	10
0.150 (No. 100)	7
75 $\mu\text{m}$ (No. 200)	5.0



## Sample Test Result

Tables 3 and 4 include data from test results performed on a field sample of asphalt mixture used in the example calculations.

**Table 3**

Field Data		
	Test method	Example values
P <sub>b</sub>	FOP for AASHTO T 308	4.60%
G <sub>mb</sub>	FOP for AASHTO T 166	2.415
G <sub>mm</sub>	FOP for AASHTO T 209	2.516

**Table 4**

Sieve Analysis FOP for AASHTO T 30	
Sieve Size mm (in.)	Percent Passing
19.0 (3/4)	100
12.5 (1/2)	86
9.5 (3/8)	77
4.75 (No. 4)	51
2.36 (No. 8)	34
01.18 (No. 16)	23
0.600 (No. 30)	16
0.300 (No. 50)	12
0.150 (No. 100)	8
75 μm (No. 200)	4.9

## Sample Calculations

### Air Voids (V<sub>a</sub>)

$$V_a = 100 \left[ \frac{(G_{mm} - G_{mb})}{G_{mm}} \right]$$

$$V_a = 100 \left[ \frac{(2.516 - 2.415)}{2.516} \right] = 4.01431 \text{ report } 4.0$$

Given:

$$G_{mm} = 2.516$$

$$G_{mb} = 2.415$$

**Percent Aggregate (Stone) ( $P_s$ )**

$$P_s = 100 - P_b$$

$$P_s = 100.0 - 4.60 = 95.40$$

Given:

$$P_b = 4.60$$

**Voids in the Mineral Aggregate (VMA)**

$$VMA = 100 - \left[ \frac{(G_{mb} \times P_s)}{G_{sb}} \right]$$

$$VMA = 100.0 - \left[ \frac{2.415 \times 95.40}{2.678} \right] = 13.96 \text{ report } 14.0$$

Given:

$$G_{sb} = 2.678$$

**Voids Filled with Asphalt (binder) (VFA)**

$$VFA = 100 \left[ \frac{(VMA - V_a)}{VMA} \right]$$

$$VFA = 100 \left[ \frac{(14.0 - 4.0)}{14.0} \right] = 71.4 \text{ report } 71$$

**Effective Specific Gravity of the Aggregate (Stone) ( $G_{se}$ )**

$$G_{se} = \frac{P_s}{\left[\left(\frac{100}{G_{mm}}\right) - \left(\frac{P_b}{G_b}\right)\right]}$$

$$G_{se} = \frac{(100 - 4.60)}{\left[\left(\frac{100}{2.516}\right) - \left(\frac{4.60}{1.020}\right)\right]} =$$

$$G_{se} = \frac{95.40}{39.74563 - 4.50980} = 2.70747 \text{ report } 2.707$$

Given:

$$G_b = 1.020$$

**Percent of Absorbed (asphalt) Binder ( $P_{ba}$ )**

$$P_{ba} = 100 \left[ \frac{(G_{se} - G_{sb})}{(G_{sb} \times G_{se})} \right] G_b$$

$$P_{ba} = 100 \left[ \frac{(2.707 - 2.678)}{(2.678 \times 2.707)} \right] 1.020 =$$

$$P_{ba} = 100 \left[ \frac{0.0290}{7.24935} \right] 1.020 = 0.40804 \text{ report } 0.41$$

**Percent of Effective (asphalt) Binder ( $P_{be}$ )**

$$P_{be} = P_b - \left[ \frac{P_{ba}}{100} \times P_s \right]$$

$$P_{be} = 4.60 - \left[ \frac{0.41}{100} \times (100 - 4.60) \right] = 4.20886 \text{ report } 4.21$$

**Dust Proportion – DP (Dust to Effective (asphalt) Binder Ratio)**

$$DP = \frac{P_{\#200}}{P_{be}}$$

$$DP = \frac{4.9}{4.21} = 1.16390 \text{ report } 1.16$$

Given:

$$P_{\#200} = 4.9$$

**Report**

- On forms approved by the agency
- Sample ID
- Air Voids,  $V_a$  to the nearest 0.1 percent
- Voids in the Mineral Aggregate, VMA to the nearest 0.1 percent
- Voids Filled with Asphalt, VFA to the nearest whole value
- Effective Specific Gravity of Aggregate (stone),  $G_{se}$  to the nearest 0.001
- Percent of Absorbed (asphalt) Binder,  $P_{ba}$  to the nearest 0.01
- Percent Effective (asphalt) Binder,  $P_{be}$  to the nearest 0.01
- Dust Proportion, DP to the nearest 0.01

### Appendix - Formulas

#### Air Voids ( $V_a$ )

$$V_a = 100 \left[ \frac{(G_{mm} - G_{mb})}{G_{mm}} \right]$$

Where:

$V_a$  = air voids in compacted mixture, percent of total volume (report to 0.1)

$G_{mm}$  = maximum specific gravity of paving mixture (AASHTO T 209)

$G_{mb}$  = bulk specific gravity of compacted mixture (AASHTO T 166)

#### Percent Aggregate (Stone) ( $P_s$ )

$$P_s = 100 - P_b$$

Where:

$P_s$  = percent aggregate (stone) percent by total weight

$P_b$  = asphalt binder content (AASHTO T 308)

#### Voids in the Mineral Aggregate (VMA)

$$VMA = 100 - \left[ \frac{(G_{mb} \times P_s)}{G_{sb}} \right]$$

Where:

VMA = voids in mineral aggregate, percent of bulk volume (report to 0.1)

$G_{sb}$  = bulk specific gravity of combined aggregate (AASHTO T 85 / T 84 or agency approved method from Job Mix Formula)

$G_{mb}$  = bulk specific gravity of compacted mixture (AASHTO T 166)

$P_s$  = aggregate content, percent by total weight = 100 -  $P_b$

$P_b$  = asphalt binder content (AASHTO T 308) percent by total weight

#### Voids Filled with Asphalt (binder) (VFA)

$$VFA = 100 \left[ \frac{(VMA - V_a)}{VMA} \right]$$

Where:

VFA = voids filled with asphalt, percent of VMA (report to 1)

VMA = voids in mineral aggregate, percent of bulk volume

$V_a$  = air voids in compacted mixture, percent of total volume.

**Effective Specific Gravity of the Aggregate (Stone) ( $G_{se}$ )**

$$G_{se} = \frac{P_s}{\left[\left(\frac{100}{G_{mm}}\right) - \left(\frac{P_b}{G_b}\right)\right]}$$

Where:

- $G_{se}$  = effective specific gravity of combined aggregate (report to 0.001)
- $P_s$  = aggregate content, percent by total weight = 100 –  $P_b$
- $G_{mm}$  = maximum specific gravity of mix (AASHTO T 209)
- $P_b$  = asphalt binder content (AASHTO T 308) percent by total weight
- $G_b$  = specific gravity of asphalt binder (JMF or asphalt binder supplier)

**Percent of Absorbed (asphalt) Binder ( $P_{ba}$ )**

$$P_{ba} = 100 \left[ \frac{(G_{se} - G_{sb})}{(G_{sb} \times G_{se})} \right] G_b$$

Where:

- $P_{ba}$  = absorbed asphalt binder (report to 0.01) percent of aggregate
- $G_{se}$  = effective specific gravity of combined aggregate
- $G_{sb}$  = bulk specific gravity of combined aggregate (AASHTO T 85 from Job Mix Formula)
- $G_b$  = specific gravity of asphalt binder (JMF or asphalt binder supplier)

**Percent of Effective (asphalt) Binder ( $P_{be}$ )**

$$P_{be} = P_b - \left[ \frac{P_{ba}}{100} \times P_s \right]$$

Where:

- $P_{be}$  = effective asphalt binder content (report to 0.01), percent by total weight
- $P_s$  = aggregate content, percent by total weight = 100 –  $P_b$
- $P_b$  = asphalt binder content (AASHTO T 308) percent by total weight
- $P_{ba}$  = absorbed asphalt binder

**Dust Proportion – DP (Dust to Effective (asphalt) Binder Ratio)**

$$DP = \frac{P_{-200}}{P_{be}}$$

Where:

- DP = Dust Proportion, (dust-to-binder ratio) (report to 0.01)
- $P_{-200}$  = aggregate passing the -#200 (75  $\mu$ m) sieve, percent by mass of aggregate (AASHTO T 30)
- $P_{be}$  = effective asphalt binder content, percent by total weight

## REVIEW / PRATICE Exam for TM 13

**\*\* Only use for review / practice**

- Start each formula using the “Reported answer”.
  - All steps for each formula will be carried 5 (five) places right of the decimal.
  - "Calculated values" will be carried to 5 (five) decimal places right of the decimal.
  - “Reported answers” will be carried to required decimal places right of decimal.
- Rounding: all numbers will be rounded up at 5

1) An asphalt mixture sample was taken from Project 6471: Calculate the Asphalt mixture following properties:

**Given:**

From the Mix Design:

G <sub>b</sub>	1.031
G <sub>sb</sub> (combined)	2.687

Field Sample:

T 209 G <sub>mm</sub> average of two samples	2.514
T 166 G <sub>mb</sub> average of two samples	2.451
T 308 P <sub>b</sub>	5.51
T 30 P-#200	6.6

PROPERTY	Calculated Value (5 decimal places)	REPORTED ANSWER
V <sub>a</sub> (0.1%)		
P <sub>s</sub> (0.01)		
VMA (0.1%)		
VFA (1)		
G <sub>se</sub> (0.001)		
P <sub>ba</sub> (0.01)		
P <sub>be</sub> (0.01)		
DP (0.01)		

REVIEW ONLY



# REVIEW / PRACTICE Exam for TM 13

## Answer Sheet

V <sub>a</sub> (0.1%)	2.5
P <sub>s</sub>	94.49
VMA (0.1%)	13.8
VFA (1)	82
G <sub>se</sub> (0.001)	2.744
P <sub>ba</sub> (0.01)	0.80
P <sub>be</sub> (0.01)	4.75
DP (0.01)	1.39

$$V_a = 100 \left[ \frac{(2.514 - 2.451)}{2.514} \right] \quad V_a = 100 \left[ \frac{(0.06300)}{2.537} \right] \quad V_a = 100[0.02506]$$

$$V_a = 2.50597 \quad \mathbf{V_a = 2.5}$$

$$P_s = 100 - 5.51$$

$$\mathbf{P_s = 94.49}$$

$$VMA = 100 - \left[ \frac{2.451 \times 94.49}{2.687} \right] \quad VMA = 100 - \left[ \frac{231.59499}{2.687} \right] \quad VMA = 100 - 86.19092$$

$$VMA = 13.80908 \quad \mathbf{VMA = 13.8}$$

$$VFA = 100 \left[ \frac{(13.8 - 2.5)}{13.8} \right] \quad VFA = 100 \left[ \frac{(11.3)}{13.8} \right] \quad VFA = 100[0.81884]$$

$$VFA = 81.88406 \quad \mathbf{VFA = 82}$$

---

$$G_{se} = \frac{(100 - 5.51)}{\left[ \left( \frac{100}{2.514} \right) - \left( \frac{5.51}{1.031} \right) \right]} \quad G_{se} = \frac{(94.49)}{[(39.77725) - (5.34433)]} \quad G_{se} = \frac{94.49}{[34.43292]}$$

$$G_{se} = 2.74418 \quad \mathbf{G_{se} = 2.744}$$

---

$$P_{ba} = 100 \left[ \frac{(2.744 - 2.687)}{(2.687 \times 2.744)} \right] 1.030 \quad P_{ba} = 100 \left[ \frac{0.05700}{7.37313} \right] 1.031 \quad P_{ba} = 100[0.00773]1.031$$

$$P_{ba} = 0.79696 \quad \mathbf{P_{ba} = 0.80}$$

---

$$P_{be} = 5.51 - \left[ \frac{0.80}{100} (100 - 5.51) \right] \quad P_{be} = 5.51 - [0.00800 \times 94.49] \quad P_{be} = 5.51 - 0.75592$$

$$P_{be} = 4.75408 \quad \mathbf{P_{be} = 4.75}$$

---

$$DP = \frac{6.6}{4.75} \quad DP = 1.38947 \quad \mathbf{DP = 1.39}$$

## LABORATORY PREPARED ASPHALT MIXTURE SPECIMENS WAQTC TM 14

### Significance

The objective of asphalt mixture design is to determine the proper combination of asphalt binder, aggregates, and additives that will provide long lasting performance as part of the pavement structure. Mix designing involves laboratory procedures developed to establish the proper proportion of materials for use in asphalt paving mixtures. Correctly designed asphalt mixtures can be expected to perform successfully for many years.

### Scope

This practice covers preparing asphalt mixture samples according to an established job mix formula (JMF). The aggregate, asphalt binder, and additives are proportioned based on the JMF and mixed to produce samples for testing or verification of the JMF. These specimens can be used for determining ignition furnace asphalt binder content and aggregate correction factors, performance testing, and other Quality Assurance measures.

There are several practices for batching material in the laboratory. This procedure covers the Iterative Method of batching material and provides a process for checking the accuracy of the batched test samples by confirming the gradation of a batched test sample.

### Terminology

- RAP – Recycled Asphalt Pavement
- RAS – Recycled Asphalt Shingles
- Cold feed – Term used to reference plant settings for percentages of the individual constituents.
- Iterative Method – Batching process that is repeated until the desired gradation is achieved.
- Batch Plan – A mathematical process that assists with the batching of the materials.

### Apparatus

- Thermometer(s), or other temperature measuring device(s), with a temperature range of 50-500°F.
- Oven: Capable of maintaining  $230 \pm 9^\circ\text{F}$ .
- Forced air, ventilated or convection oven: Capable of maintaining the temperature surrounding the sample at  $325 \pm 9^\circ\text{F}$ .
- Bins, pans, or buckets of adequate size to accommodate fractionated material for each stockpile separated size.
- Labels for each bin that note the aggregate designation and sieve size upon which the material was retained.

- Lids or plastic coverings for bins and buckets to minimize moisture absorption in the fractionated material during storage if necessary.
- Drying/batch containers: Shallow flat metal pans large enough to accommodate a batched sample.
- Balance or scale: Capacity sufficient for the sample mass, accurate to 0.1 percent of the sample mass or readable to 0.1 g
- Sieves: meeting the requirements of the FOP for AASHTO T 27/T 11.
- Mechanical sieve shaker: meeting the requirements of the FOP for AASHTO T 27/T 11.
- Mechanical washing apparatus (optional)
- Suitable drying equipment: meeting the requirements of the FOP for AASHTO T 255.
- Containers: A pan or vessel of a size sufficient to contain the sample covered with water and to permit vigorous agitation without loss of any part of the sample or water.
- Utensils: Spoons, spatulas, brushes, stirring rods, etc.
- Mixer: Of sufficient capacity and design to adequately combine all ingredients.

### Material Sampling

1. Obtain representative samples of aggregate, from each stockpile listed on the JMF, according to the FOP for AASHTO R 90.
2. Obtain samples of asphalt binder according to the FOP for AASHTO R 66.
3. Obtain hydrated lime from the supplier listed on the JMF, if used.
4. Obtain anti-stripping agent from the supplier listed on the JMF, if used.
5. Obtain representative recycled material samples, after the material has been processed for hot mix production use, according to FOP for AASHTO R 90, if used.

**Note 1:** RAP is material recovered from existing roadways during milling operations or pavement removal during construction. Most RAP requires reprocessing to be useable in new asphalt mixtures. Processing may include crushing and screening of the material.

### Aggregate Preparation

Obtain quality control gradation reports of the separated sizes or stockpiled materials listed on the JMF. The average gradation, expressed as a percent retained, of each stockpile will be used to verify JMF target gradation. If recycled material (RAP or RAS) is included in the JMF, verify the asphalt binder content and gradation are listed.

The virgin aggregates used in the blend may be batched unwashed or washed, according to agency requirements.

### Fractionating of Virgin Aggregate

1. Dry each stockpile sample according to the FOP for AASHTO T 255.
2. After drying, cool and cover, if necessary, to minimize moisture absorption.
3. Select sieves required by the specification. Separate each stockpile sample into individual size fractions according to the FOP for AASHTO T 27/T 11.
4. Carefully empty the material retained on each sieve into a bin, pan, or bucket, and label according to size.

*Note 2:* To reduce the number of sizes of fractionated aggregates from which the batch is prepared, agencies may allow small amounts to be added from other stockpiles. Stockpiles should meet the criteria in Appendix A, Aggregate Batching.

5. Cover, if necessary, to prevent moisture absorption.

### Wash Fractionated Aggregate

When the agency requires, the fractionated aggregate is washed and dried before batching test samples. The adherent fines that are washed out are replaced with material passing the 75  $\mu\text{m}$  (No. 200) sieve during batching.

1. Wash each size of fractionated aggregate according to the FOP for AASHTO T 27/11, except for the material passing the 75  $\mu\text{m}$  (No. 200) sieve or “Dust.”

*Note 3:* Adherent fines may have different properties than sieved minus 75  $\mu\text{m}$  (No. 200) material.

2. Dry according to the FOP for AASHTO T 255.
3. Store in separate bins or buckets, label according to size and cover, if necessary.

### RAP

If RAP, RAS, or both, is included in the JMF:

1. Dry the processed recycled material overnight or to constant mass at  $125 \pm 5^\circ\text{F}$ .

*Note 4:* Constant mass is achieved when successive mass determinations do not change more than 0.05 percent after an additional 2 hours of drying.

2. Cover and cool.

### Aggregate Batch Plan

Batch plans are developed one virgin aggregate stockpile at a time starting with the coarsest stockpile and progressing through the finer stockpiles.

Determine all masses to the nearest 0.1 percent of the sample mass or to the nearest 0.1 g.

1. Calculate the required mass for each stockpile (virgin stockpile, lime, RAP, etc.) by multiplying the desired sample size by the cold feed percentage for each stockpile and record to the nearest 0.1 g. The sum of the individual masses must add up to the desired total sample mass.
2. Calculate the percent retained for each sieve of the aggregate portions using the control gradation average.

3. Calculate the mass per sieve per stockpile. Start with the coarsest virgin aggregate stockpile, multiply the individual mass for that stockpile by the percent retained on each sieve and record to the nearest 0.1 g.
4. Identify the sieve sizes that material from other stockpiles will be added. Document the mass and the contributing stockpile. See Note 2.
5. Calculate a cumulative mass total beginning with the largest sieve on the coarsest stockpile. Begin the cumulative total on subsequent finer stockpiles with the ending cumulative total from the previous stockpile.

*Note 5:* Cumulative masses are used so that the balance is not re-zeroed between each addition possibly causing a misrepresentation of the total mass. Repeat with each successive stockpile. If cumulative totals are not used, verify mathematically that the batch plan produces the correct mass of virgin aggregate for each stockpile and the total of all virgin stockpiles.

**Verification of Aggregate Batch Plan**

When the fractionated aggregate is not washed before batching, the minus 0.075 (No. 200) batch plan mass may need to be adjusted to compensate for adherent fines.

1. Batch the desired sample size according to the batch plan, excluding recycled material, if applicable.

*Note 6:* Refer to the FOP for AASHTO T 308 Table 1 for recommended sample size.

2. Perform washed sieve analysis according to the FOP for AASHTO T 27/T 11.
3. The batched sample percent passing must agree with the Virgin Blend Percent Passing (JMF) within the tolerances of Table 1. If the variation exceeds the allowable difference, adjust the virgin aggregate portion of the batch plan and reverify.

**Table 1**  
**Allowable Differences Between Batched and Actual Gradations**

Sieves	Allowable Difference (%Passing)
Larger than No. 8	±1.5%
No. 8 to No. 50	±1.0%
Smaller than No. 50	±0.5%

### Aggregate Preparation

1. Batch the number of samples at desired sample size according to the batch plan, excluding recycled material, if applicable.

### Hydrated Lime

When hydrated lime is mixed with water before incorporating into the mixture, add to the test samples the night before mixing with asphalt binder (approximately 12 hours).

1. Determine the mass of hydrated lime to be added to the test sample based on the percent required in the JMF. For mixtures with RAP, the percentage is applied to the virgin aggregate only.
2. Weigh out the mass of hydrated lime required for each test sample and store in a closed tin with the test sample.
3. Add the hydrated lime to the test sample in an oven proof container.
4. Using a spoon or spatula, thoroughly stir the lime into the dry aggregate sample.
5. Add sufficient water to thoroughly wet all the aggregate and achieve a “Surface Damp Condition.”
6. Stir the lime, aggregate and water for approximately five minutes to thoroughly combine. Do not lose any fine material. Spatulas and brushes may be used to clean the fine material from the implements. Do not transfer the mixed sample.
7. Place the mixed sample in the oven, set oven temperature in the mixing temperature range.
8. Dry according to the FOP for AASHTO T 255.

### Mixing Preparation

1. Heat the mixing equipment such as bowls, mixing paddles, spoons, etc.
2. Heat aggregate samples 20°F above the JMF mixing temperature.

*Note 7:* Heating aggregate above mixing temperature allows for loss of heat during the addition of the asphalt binder. Over 20 °F higher may burn the asphalt binder when it is added to the hot aggregate.

3. If RAP material is required, heat carefully in a controlled oven for approximately 2 hrs. at  $230 \pm 9^\circ\text{F}$ .
4. Heat asphalt binder approximately 10°F above the mixing temperature range. Discard unused asphalt binder after the 3 hrs.

### Liquid anti-stripping agent

If liquid anti-stripping agent is required:

- a) Determine the mass of anti-stripping agent to be added to the asphalt binder based on the percent required in the JMF. The percentage is applied to the asphalt binder only.
- b) Follow mixing instructions from the anti-stripping agent supplier, as not all products are incorporated in the same manner.

- c) Heat the anti-stripping agent to  $125 \pm 15$  ° F or temperature range from manufacturer labeling.
- d) Determine and record mass of a clean container.
- e) Add asphalt binder, determine and record asphalt binder mass.
- f) Calculate the mass of anti-stripping agent to be added.
- g) Zero the scale and add calculated mass of anti-stripping agent. Record the measured mass of anti-stripping agent.
- h) Discard material if too much anti-stripping agent is added.

**Note 8:** Use of a small spoon or stirring rod will assist with anti-strip addition.

- i) Stir the combined sample thoroughly with a small spoon or stirring rod.
- j) Loosely place a lid on the container to prevent dissipation of the additive. Do not secure the lid, expansion could cause injury or loss of material.
- k) Place the combined material in an oven at the JMF mixing temperature range. During binder addition ensure product is stirred thoroughly before each use.

**Note 9:** Because the elastic properties of asphalt binder degrade when held at high temperatures, the asphalt binder must be used within 3 hrs. of achieving the mixing temperature.

### Mixing Procedure

1. Prepare an initial specimen at the design asphalt binder content to “butter” the mixing bowl and utensils. Discard the specimen after mixing, scrape the bowl and paddle or whip with a spatula or other suitable tool.
2. Record mass of “battered” bowl, spatula, and paddle or whip.
3. Remove the spatula and paddle or whip; zero the balance with empty bowl. Introduce the aggregate, mix thoroughly with clean, dry spatula or spoon. Record mass of aggregate,  $M_{\text{agg}}$ .
4. If RAP is required, introduce the hot RAP and mix thoroughly with the virgin aggregate. Record this mass. Determine  $M_{\text{RAP}}$  by subtracting the  $M_{\text{agg}}$  from the mass of aggregate and RAP.
5. Form a crater in the center of the material.
6. Calculate  $M_{\text{binder}}$ .
7. Zero the scale and add calculated mass of asphalt binder. Record the measured mass of asphalt binder added.

**Note 10:** If too much asphalt binder is added, it may be removed by dipping a corner of a paper towel in the center of the asphalt binder.

8. Thoroughly mix for a minimum of two minutes, by hand or mixer, until asphalt binder is uniformly distributed, and aggregate is completely coated.
9. Stop the mixer, if used.
10. Stir mixture with buttered spatula, scraping the center bottom of the mixing bowl.



11. If the aggregate is not thoroughly coated, continue mixing until completely coated.
  12. Remove mixture from bowl.
  13. Scrape bowl and paddle or whip with buttered spatula. Place all the mixture into a pan.
  14. Record mass of empty bowl, spatula, and paddle or whip. Ensure the combined mass and the mass of the initial buttered bowl and utensils is within 0.10 percent of the sample mass of the mixed sample.
- Note 11:* For a 4700 g sample, 0.10% = 4.7 g. and for a 2100 g sample, 0.10% = 2.1 g.
15. Age the mixed specimen according to AASHTO R 30 or agency requirements.
  16. Repeat steps 3 thru 15 for each specimen to be mixed.

## Calculations

### Trial Batch Plan

#### Mass of material contributed per stockpile:

$$\text{mass per stockpile} = \text{sample size} \times \text{stockpile}\%$$

Where:

mass per stockpile	=	mass of material from each stockpile in test sample
sample size	=	desired mass of test sample
stockpile%	=	percent of each stockpile in the mixture (JMF)

#### Mass of material contributed to each sieve per stockpile:

$$\text{mass per stockpile per sieve} = \text{mass per stockpile} \times \% \text{retained per sieve}$$

Where:

mass per stockpile per sieve	=	amount of fractionated aggregate from each stockpile for each sieve size
%retained per sieve	=	percent retained on each sieve (calculated from crushing records)

#### Anti-stripping agent mass added before heating asphalt binder:

$$M_{\text{additive}} = \% \text{additive} \times M_{\text{heated binder}}$$

$M_{\text{additive}}$	=	mass of anti-stripping agent to be added to the mass of measured asphalt binder
%additive	=	percent of anti-stripping agent, based on mass of asphalt binder, from JMF
$M_{\text{heated binder}}$	=	mass of asphalt binder heated for mixing

## Asphalt binder mass

Asphalt binder mass is based on a percent of the mass of “hot” aggregate.

### Mixes without RAP

Determine the mass of asphalt binder to be added to a mix without RAP:

$$M_{binder} = \frac{P_b \times M_{agg}}{(100 - P_b)}$$

Where:

$M_{binder}$  = Mass of asphalt binder to be added to the prepared test sample

$P_b$  = Required percent asphalt binder

$M_{agg}$  = Mass of hot test sample

### Mixes with RAP

Determine the mass of asphalt binder in the RAP:

$$M_{RAP\ binder} = M_{RAP} \times \frac{P_{bRAP}}{100}$$

Where:

$M_{RAP\ binder}$  = Mass of asphalt binder in the RAP

$M_{RAP}$  = Mass of RAP in sample

$P_{bRAP}$  = Percent of asphalt binder in the RAP

Determine the amount of asphalt binder to be added to mixes with RAP:

$$M_{binder} = \left[ P_b \times \frac{(M_{agg} + M_{RAP} - M_{RAP\ binder})}{(100 - P_b)} \right] - M_{RAP\ binder}$$

## Asphalt Binder

### Anti-stripping agent mass

$$M_{additive} = \%additive \times M_{binder}$$

$$M_{additive} = 0.25\% \times 850\text{ g} = 2.1\text{ g}$$

Given:

$$\%additive = 0.25\%$$

$$M_{binder} = 850\text{ g.}$$

**Asphalt binder mass – mixtures without RAP**

$$M_{binder} = \frac{P_b \times M_{agg}}{(100 - P_b)}$$

$$M_{binder} = \frac{6.0\% \times 4500.0 \text{ g}}{(100\% - 6.0\%)} = \frac{2700.0 \text{ g}}{94.0\%} = 287.2 \text{ g}$$

Given:

$$P_b = 6.0 \% \text{ from JMF}$$

$$M_{agg} = 4500.0 \text{ g hot aggregate}$$

**Note 13:** A factor can be determined for subsequent specimens by taking  $P_b$  divided by  $100 - P_b$ . Then the hot aggregate mass is multiplied by this factor for an expedient oil add determination.

**Asphalt binder mass – mixtures with RAP**

Determine mass of asphalt binder in RAP:

$$M_{RAP \text{ binder}} = M_{RAP} \times \frac{P_{bRAP}}{100}$$

$$M_{RAP \text{ binder}} = 1125.0 \text{ g} \times \frac{4.88\%}{100} = 54.9 \text{ g}$$

Given:

$$M_{RAP} = 1125.0 \text{ g}$$

$$P_{bRAP} = 4.88\%$$

Determine mass of asphalt binder:

$$M_{binder} = \left[ P_b \times \frac{(M_{agg} + M_{RAP} - M_{RAP \text{ binder}})}{(100 - P_b)} \right] - M_{RAP \text{ binder}}$$

$$M_{binder} = \left[ 6.0\% \times \frac{(4500 \text{ g} - 54.9 \text{ g})}{(100\% - 6.0\%)} \right] - 54.9 \text{ g} = 228.8 \text{ g}$$

$$P_b = 6.0 \text{ percent from JMF}$$

$$M_{agg} = 3375.0 \text{ g}$$

$$M_{agg} + M_{RAP} = 4500.0 \text{ g hot aggregate and RAP}$$

**Check of Calculation**

$$\left[ \frac{(54.9g + 228.8g)}{(4500g + 228.8g)} \right] \times 100 = 6.0\%$$

**Report**

- Project name
- Date of batching
- Specimen identification
- Virgin aggregate mass
- RAP mass, if required
- Percentage of asphalt binder in specimen, nearest 0.1 percent
- Asphalt binder mass
- Anti-Strip mass, if applicable
- Conditioning process

## APPENDIX—AGGREGATE BATCHING

(Non-Mandatory Information)

The following guidelines should be considered when batching virgin aggregates that have small amounts of retained material that are encountered during the separation phase and will reduce the number of containers required for material storage:

- The percent retained for the sieve to be moved is less than 10 percent. Material meeting this condition must have a retained like size on the next stockpile or batching of the separated size will be required.
- Stockpiles to be combined are from the same source and same parent material. Aggregates from different sources should not be combined.
- The particle shape and texture are essentially the same for the sieve sizes to be combined.

Stockpiles are produced using similar processes (e.g. do not mix stockpiles of crushed material with stockpiles of uncrushed material; do not mix unwashed stockpiles with washed stockpiles, etc.).

### Example

Batch a gyratory sample of 4750 g. of asphalt mixture, the aggregate portion will be about 4500 g. The mixture is to have 25 percent RAP with three virgin stockpiles of 18, 27, and 30 percent.

#### Batch Mass for the 12.5 to 4.75 mm (1/2 in. to No. 4) stockpile

$$\text{Required mass} = 4500 \text{ g} \times \frac{18\%}{100} = 810.0 \text{ g}$$

Stockpile	12.5 to 4.75 mm (1/2 in. to No. 4)	4.75 to 1.18 mm (No. 4 to No. 8)	4.75 to 1.18 mm (No. 4 to No. 8)	RAP
<b>Cold feed %</b>	18%	27%	30%	25%
<b>Batch Mass</b>	810.0 g.	1215.0 g	1350.0 g	1125.0 g

The sum of the batch masses must add up to the original aggregate target mass, in this example: 810.0 g + 1215.0 g + 1350.0 g + 1125.0 g = 4500.0 g.

**Mass per sieve for 12.5 to 4.75 mm (1/2 in. to No. 4) stockpile**

Sieve Size mm (in.)	%Retained	Batch Mass g	Mass Carried to Next Pile g	Cumulative Batch Mass g
25 (1)	0.0	0.0	0.0	<b>0.0</b>
19.0 (3/4)	0.0	0.0	0.0	<b>0.0</b>
12.5 (1/2)	3.3	26.7	0.0	<b>26.7</b>
9.5 (3/8)	49.4	400.1	0.0	<b>426.8</b>
6.25 (1/4)	39.8	322.4	0.0	<b>749.2</b>
4.75 (No. 4)	3.5	28.4	-28.4	
2.36 (No. 8)	1.7	13.8	-13.8	
1.18 (No. 16)	0.2	1.6	-1.6	
0.600 (No. 30)	0.0	0.0	0.0	
0.300 (No. 50)	0.1	0.8	-0.8	
0.150 (No. 100)	0.0	0.0	0.0	
0.075 (No. 200)	0.0	0.0	0.0	
Minus 0.075 (No. 200)	2.0	16.2	-16.2	
<b>Total</b>	<b>100.0</b>	<b>810.0</b>	<b>-60.8</b>	

The %Retained column must equal 100.0 percent. The Batch Mass Column should equal 810.0 g.

The Total Batch Mass plus the Mass Carried to Next Pile for sieves smaller than the 6.25 mm (1/4 in.) is 810.0 g + (- 60.8 g) = 749.2 g.

The minus sign shows mass is being removed from this portion of the Batch Plan. It will be added to the next (pile plus sign).

*Note 12:* Carrying minor amounts of material when batching as in this example reduces the number of fractionated sizes. In case, there are eight less bins from just this stockpile.

The material retained on the 12.5 mm (1/2 in) was 3.3 % and meets the less than 10 percent requirement but doesn't have a like material in the next stockpile, so it must be batched.

Continue with the next stockpile, 4.75 to 1.18 mm (No. 4 to No. 8).

**Mass per sieve for 4.75 to 1.18 mm (No. 4 to No. 8) stockpile**

Sieve Size mm (in.)	%Retained	Batch Mass g	Mass Carried to Next Pile g	Cumulative Batch Mass g
25 (1)	0.0	0.0	0.0	749.2
19.0 (3/4)	0.0	0.0	0.0	
12.5 (1/2)	0.0	0.0	0.0	
9.5 (3/8)	1.3	15.8	0.0	765.0
6.25 (1/4)	29.5	358.4	0.0	1123.4
4.75 (No. 4)	28.4	345.1 + 28.4	0.0	1496.9
2.36 (No. 8)	32.4	393.7 + 13.8	0.0	1904.4
1.18 (No. 16)	4.1	49.8 + 1.6	-51.4	
0.600 (No. 30)	1.1	13.4 + 0.0	-13.4	
0.300 (No. 50)	0.6	7.3 + 0.8	-8.1	
0.150 (No. 100)	0.3	3.6 + 0.0	-3.6	
0.075 (No. 200)	0.0	0.0 + 0.0	0.0	
Minus 0.075 (No. 200)	2.3	27.9 + 16.2	-44.1	
<b>Total</b>	<b>100.0</b>	<b>1215.0 + 60.8</b>	<b>-120.6</b>	

%Retained equals 100.0, the batch mass equals the 1215.0 g. with 60.8 g. being carried from the 12.5 to 4.75 mm (1/2 in. to No. 4).

**Mass per sieve for 44.75 to 1.18 mm (No. 4 to No. 8) stockpile**

Sieve Size mm (in.)	Adjusted QL %Retained	Batch Mass g	Cumulative Batch Mass g
25 (1)	0.0	0.0	1904.4
19.0 (3/4)	0.0	0.0	
12.5 (1/2)	0.0	0.0	
9.5 (3/8)	0.0	0.0	
6.25 (1/4)	0.0	0.0	
4.75 (No. 4)	0.2	2.7	1907.1
2.36 (No. 8)	20.2	272.7	2179.8
1.18 (No. 16)	26.5	357.8 + 51.4	2589.0
0.600 (No. 30)	17.1	230.8 + 13.4	2833.2
0.300 (No. 50)	14.8	199.8 + 8.1	3041.1
0.150 (No. 100)	11.9	160.7 + 3.6	3205.4
0.075 (No. 200)	2.8	37.8 + 0.0	3243.2
Minus 0.075 (No. 200)	6.5	87.7 + 44.1	3375.0
<b>Total</b>	<b>100.0</b>	<b>1350.0 + 120.6</b>	

The final Cumulative Batch Mass matches the sum of the three virgin stockpiles, 810.0 + 1215.0 + 1350.0 = 3375.0.





## Performance Exam Checklist

### WAQTC TM 14

#### Laboratory Prepared Asphalt Mixture Specimens

Participant Name: \_\_\_\_\_ Exam Date: \_\_\_\_\_

Record the symbols "P" for passing or "F" for failing on each step of the checklist.

Procedure Element	Trial 1	Trial 2
1. The tester has a copy of the current procedure on hand?	_____	_____
2. All equipment is functioning according to the test procedure, and if required, has the current calibration/standardization/check tags present?	_____	_____
<b>Material Sampling Element</b>		
3. Representative samples of aggregate identified on JMF obtained per FOP for AASHTO R 90?	_____	_____
4. Representative samples of asphalt binder identified on JMF obtained per FOP for AASHTO R 66?	_____	_____
5. If required, hydrated lime obtained from supplier?	_____	_____
6. If required, anti-stripping agent obtained from supplier?	_____	_____
7. If required, representative samples of recycled material (RAP, RAS) sufficient for production use obtained per FOP for AASHTO R 90?	_____	_____
<b>Aggregate Preparation Element</b>		
8. Aggregate dried according to FOP for AASHTO T 255?	_____	_____
9. Aggregate separated into individual size fractions according to FOP for AASHTO T 27_T 11?	_____	_____
10. Material retained on each sieve placed in separate containers?	_____	_____
11. Separated aggregates washed, except the portion passing the No. 200 (0.075 mm) sieve, in accordance with FOP for AASHTO T 27_T 11?	_____	_____
12. Washed aggregate samples dried according to FOP for AASHTO T 255?	_____	_____
13. If required, recycled material (RAP, RAS) dried overnight or to constant mass at 125 ± 5°F?	_____	_____
14. All dried and cooled material stored as necessary to prevent moisture absorption?	_____	_____

Procedure Element	Trial 1	Trial 2
<b>Mixing Preparation Element</b>		
15. Aggregate batch plan developed off JMF and calculated based on cumulative totals?	_____	_____
16. Number of samples at desired sample size determined by the specific test procedure to be performed?	_____	_____
17. Mixing equipment (bowls, mixing paddles, spoons/scrapers, etc.) heated?	_____	_____
18. Aggregate heated 20°F above JMF mixing temperature?	_____	_____
19. If required, RAP material carefully heated for approximately 2 hrs. at 230 ± 9°F?	_____	_____
20. Asphalt binder heated 10°F above JMF mixing temperature?	_____	_____
21. If required, liquid anti-stripping agent incorporated as instructed by supplier or as defined in step 4. a) – k)?	_____	_____
<b>Mixing Procedure Element</b>		
22. A prepared specimen used to butter all mixing equipment and discarded?	_____	_____
23. Mass of buttered bowl and paddle recorded?	_____	_____
24. Heated aggregate introduced into tared empty bowl and mixed thoroughly?	_____	_____
25. Mass of aggregate recorded?	_____	_____
26. If required, RAP material introduced with heated aggregate and mixed thoroughly?	_____	_____
27. Mass of RAP recorded?	_____	_____
28. Crater formed?	_____	_____
29. Scale tared and calculated mass of asphalt binder added?	_____	_____
30. All material thoroughly mixed for a minimum of two minutes or until completely coated?	_____	_____
31. All mixture placed into pan and mixing equipment scraped back to buttered condition?	_____	_____
32. Mass of empty bowl and paddle recorded and not more than 0.10 percent of total sample mass has been gained or loss?	_____	_____
33. If required, mixture specimen aged according to AASHTO R 30?	_____	_____
34. Steps repeated for each specimen to be mixed?	_____	_____
35. All calculations performed correctly?	_____	_____

Tester qualified in performing TM14 Gyrotory samples. Date: \_\_\_\_\_

Tester qualified in performing TM14 including RAP/RAS. Date: \_\_\_\_\_

Tester qualified in performing TM14 HWTD/IDT/Ideal CT. Date: \_\_\_\_\_

Tester qualified in performing TM14 to include Anti-strip. Date: \_\_\_\_\_

Tester qualified in performing TM14 Rice samples. Date: \_\_\_\_\_

Tester qualified in performing TM14 IFCF samples. Date: \_\_\_\_\_

Comments: First Attempt: Pass \_\_\_\_\_ Fail \_\_\_\_\_ Second Attempt: Pass \_\_\_\_\_ Fail \_\_\_\_\_

Examiner Signature: \_\_\_\_\_ WAQTC #: \_\_\_\_\_



# WSDOT Errata to WAQTC TM 15

## Laboratory Theoretical Maximum Dry Density of Granular Soil and Soil/Aggregate

WAQTC TM 15 has been adopted by WSDOT with the following changes:

### Apparatus

Replace with below:

- **Small Mold Assembly:** includes mold, mold base, and mold follower.
  - **Small Mold:** ASTM 513 DOM Steel Tubing; volume approximately 0.003 m<sup>3</sup> (0.1 ft.<sup>3</sup>); 165 mm (6.500 in.) O.D. nominal, 6.4 mm (0.250 in.) wall thickness, I.D. 152.4 ± 0.8 mm (6 ± 0.032 in.); Height 203.2 ± 1.6 mm (8 ± 0.064 in.). In-service molds not to exceed a I.D. of 153.9 mm (6.064 in.).
  - **Small Mold Base:** Removable from mold, 15.9 mm (0.625 in.) nominal plate steel. Both surfaces ground to between 15.8 to 13.6 mm (0.624 to 0.536 in.) thick.
  - **Small Mold Follower:** Plate Steel with an edge thickness of 12.7 mm ± 1.6 mm (0.500 ± 0.064 in.). New follower diameter tolerance of - 0.8 mm to - 1.6 mm (- 0.032 to - 0.064 in.) of the diameter of the matching small mold. In-service follower shall not exceed - 3.2 mm (- 0.125 in.).
- **Large Mold Assembly:** includes mold, mold base, and mold follower.
  - **Large mold:** ASTM 513 DOM Steel Tubing; 267 mm (10.500 in.) O.D. nominal, 6.4 mm (0.250 in.) wall thickness, I.D. 254.0 ± 0.8 mm (10 ± 0.032 in.); Internal Height 254.0 ± 1.6 mm (10 ± 0.064 in.). In- service molds not to exceed a I.D. of 255.6 mm (10.064 in.).
  - **Large Mold Base:** 6.3 to 9.5 mm (0.250 to 0.375 in.) plate steel. Skip welded or fully welded to the mold
  - **Large Mold Follower:** Plate Steel with an edge thickness of 12.7 mm ± 1.6 mm (0.500 ± 0.064 in.). New follower diameter tolerance of - 0.8 mm to - 1.6 mm - (0.032 in. to 0.064 in.) of the diameter of the matching mold. In-service follower shall not exceed - 3.2 mm (- 0.125 in.).

### Sample Preparation

Replace step one with below:

1. Obtain a representative sample according to Table 3 below.

Table 3 TM15 Sample Size		
	Minimum Mass lb (kg)	
If no more than 15 percent by weight of aggregate exceeds 19 mm (¾ in.)	210	95
If 15 percent or more by weight of aggregate exceeds 19 mm (¾ in.)	330	150

### Theoretical Maximum Density Curve Development

Replace with below:

WSDOT Employees – Enter laboratory data into MATS to develop the maximum density chart and maximum density curve.

Non-WSDOT Employees – Enter laboratory data into WAQTC spreadsheet to develop the maximum density chart and maximum density curve. Spreadsheet available at

<http://waqtc.org/library/library.cfm>



## LABORATORY THEORETICAL MAXIMUM DRY DENSITY OF GRANULAR SOIL AND SOIL/ AGGREGATE WAQTC TM 15

### Scope

This method is used to establish the theoretical maximum dry density of granular and non-granular soil-aggregate. Use Procedure 1 for material with more than 30 percent retained on the 4.75 mm (No. 4) sieve or Procedure 2 for material with more than 30 percent retained on the 19.0 mm (¾ in.) sieve.

### Terminology

- Fine aggregate portion – material passing the 4.75 mm (No. 4) Sieve.
- Coarse aggregate portion – material retained on the 4.75 mm (No. 4) sieve.

### Significance

A theoretical maximum dry density chart and curve are developed by determining a laboratory maximum dry density of a representative sample of material passing the 4.75 mm (No. 4) and the material retained on the 4.75 mm (No. 4), and their respective apparent specific gravities ( $G_{sa}$ ). The theoretical maximum dry density chart and curve address the range of theoretical maximum dry densities due to fluctuations in coarse and fine aggregate of a given material.

To determine the laboratory maximum dry density of the fine aggregate portion, this method allows for use of the FOP for AASHTO T 99/T 180 or by vibratory compactor covered in the method.

This method is for use on granular materials having 30 to 70 percent passing the 4.75 mm (No. 4) or 19.0 mm (¾ in.) sieve.

### Apparatus

- A vibratory spring-loaded compactor – D G Parrott & Son Humphres Maximum Density machine, or equivalent.
- Small Mold Assembly: includes mold, mold base, and mold follower.
  - Mold: approximately 0.003 m<sup>3</sup> (0.1 ft.<sup>3</sup>) volume. Made of steel tubing meeting ASTM A513 with a 165 mm (6.500 in.) nominal outside diameter, 6 mm (0.250 in.) wall thickness, 152 ±1 mm (6 ±0.03 in.) inside diameter, and a height of 203 ±1 mm (8 ±0.032 in.). For in-service molds, do not to exceed 15 mm (6.060 in.) inside diameter.
  - Mold Base: 16 mm (0.625 in.) steel plate separate from the mold. Grind both surfaces to 15 ±1 mm (0.600 ±0.030 in.) thickness.

- Mold Follower: Steel plate, with a  $12 \pm 1$  mm ( $0.460 \pm 0.03$  in.) edge thickness fitting inside the mold with 1.5 mm (0.063 in.) maximum space between mold follower and mold wall. For new followers, the diameter tolerance is  $-1$  mm to  $-2$  mm ( $-0.031$  in. to  $-0.063$  in.) of the inside diameter of the matching mold.
- Large Mold Assembly: includes mold, mold base, and mold follower
  - Mold: approximately  $0.014$  m<sup>3</sup> (0.5 ft.<sup>3</sup>) volume. Made of steel tubing meeting ASTM A513 with a 267 mm (10.500 in.) nominal outside diameter, 6 mm (0.250 in.) wall thickness,  $254 \pm 1$  mm ( $10 \pm 0.032$  in.) inside diameter, and a height of  $254 \pm 1$  mm ( $10 \pm 0.032$  in.). For in-service molds, do not to exceed 256 mm (10.060 in.) inside diameter.
  - Mold Base: 6 to 8 mm (0.250 to 0.312 in.) steel plate skip welded or fully welded to the mold.
  - Mold Follower: Steel plate, with  $14 \pm 1$  mm ( $0.550 \pm 0.030$  in.) edge thickness fitting inside the mold with 1.5 mm (0.063 in.) max. space between mold follower and mold wall. For new followers, the diameter tolerance is  $-1$  mm to  $-2$  mm ( $-0.031$  in. to  $-0.063$  in.) of the inside diameter of the matching mold.
- Manually operated rammer: 2.5 kg (5.5 lb.) rammer meeting the requirements of the FOP for AASHTO T 99/T 180.
- Measuring device: minimum length 150 mm (6 in.), accurate and readable to 0.25 mm (0.01 in.)
- Sieves: 75 mm (3 in.), 19 mm ( $\frac{3}{4}$  in.), and a 4.75 mm (No. 4) conforming to the FOP for AASHTO T 27/T 11
- Balance or Scale: Capacity sufficient for the principal sample mass, readable to 0.1 percent or 0.1 g, and meeting the requirements of AASHTO M 231
- Tamping rod: straight steel, 16 mm ( $\frac{5}{8}$  in.) in diameter and approximately 400 mm (24 in.) long having at least one end rounded to a hemispherical tip
- Straight edge: at least 25 mm (1 in.) longer than the diameter of the mold
- A stopwatch or timer readable to 1 second
- Miscellaneous tools including pans, spoon, trowel, mechanical mixer (optional), etc.



## Laboratory Maximum Dry Density

Select the proper method for determining the laboratory maximum dry density of the fine aggregate portion of the sample, refer to Table 1, or as directed by the agency.

Select the proper method for determining the laboratory maximum dry density of the coarse aggregate portion of the sample, refer to Table 2.

**Table 1**  
**Fine Aggregate Portion Laboratory Maximum Dry Density Method**

Estimated Soil Type	Recommended Test Method
Sandy, non-plastic, permeable soil or non-cohesive soil.	WAQTC TM 15 Vibratory Compactor
Silt, some plasticity, low permeability.	FOP for AASTHO T 99/T 180, T 99 Method A
Sandy/silt, some plasticity, permeable.	WAQTC TM 15 and FOP for AASTHO T 99/T 180, T 99 Method A (use highest results)

**Table 2**  
**Coarse Aggregate Portion Laboratory Maximum Dry Density Method**

Coarse Aggregate Amount	Test Method
No more than 15 percent by weight of the original aggregate specimen exceeds 19 mm ( $\frac{3}{4}$ in.)	WAQTC TM 15 Vibratory Compactor Procedure 1
15 percent or more by weight of the original aggregate specimen is greater than 19 mm ( $\frac{3}{4}$ in.) but does not exceed 75 mm (3 in.)	WAQTC TM 15 Vibratory Compactor Procedure 2

## Sample Preparation

1. Obtain a representative sample according to the FOP for AASTHO R 90, minimum 180 kg. (400 lbs.).
2. Reduce according to the FOP for AASTHO R 76 to a sufficient size to yield amounts required in steps 7 and 8.
3. If the sample is damp, dry until it becomes friable under a trowel. Drying may be in air or by use of a drying apparatus maintained at a temperature not exceeding 60°C (140°F).
4. Thoroughly break up aggregations in a manner that avoids reducing the natural size of individual particles.

5. Remove the material retained on the 75 mm (3 in.) sieve.
6. Separate into coarse and fine aggregate portions by passing the remainder of the sample through the 4.75 mm (No. 4) sieve.
7. Fine aggregate:
  - a. Obtain a representative sample as described in the FOP for AASHTO T 99/T 180, T 99 Method A.  
  
Or
  - b. Obtain at least three representative test samples of approximately 6 kg (13 lb.) each for the fine aggregate vibratory compactor method.
  - c. Obtain a representative sample of the remaining material and determine the apparent specific gravity ( $G_{sa}$ ) according to AASHTO T 84 or Annex B.
8. Coarse aggregate:
  - a. Obtain a representative sample of 19 mm ( $\frac{3}{4}$  in) to 4.75 mm (No. 4) of approximately 5 kg (11 lb.) for coarse aggregate vibratory compactor Procedure 1.  
  
Or
  - b. Obtain a representative sample of 75 mm (3 in) to 4.75 mm (No. 4) of approximately 20 kg (45 lb.) for coarse aggregate vibratory compactor Procedure 2.
  - c. Obtain a representative sample of the remaining material and determine the apparent specific gravity ( $G_{sa}$ ) according to FOP for AASHTO T 85 or Annex B.

### Laboratory Maximum Dry Density of Fine Aggregate Portion

Determine laboratory maximum dry density of the fine aggregate portion according to the FOP for AASHTO T 180/T 99, T 99 Method A, or the following vibratory compactor method. Refer to Table 1.

#### Vibratory Compactor Method

1. Determine and record the mass of the clean dry small mold assembly to the nearest 5 g (0.01 lb.). Designate this mass as the  $M_m$ .
2. Add enough water to one of the fine aggregate portions to saturate the sample, approximately optimum moisture. Do not over saturate (Note 1).

**Note 1:** The sample is considered saturated when one to two drops of free water are visible at the base of the mold assembly at the end of the first 2-minute load cycle, Table 3. Refer to Step 11.

3. Mix until homogenous.

4. Place approximately one third of the sample in the mold with mold base attached.
5. Consolidate with 25 strokes of the tamping rod, distribute evenly over the surface, and 25 blows of the manually operated rammer.
6. Repeat Steps 4 and 5 for two subsequent lifts. The surface of the top lift should be finished as level as possible.
7. Place the follower on top of the molded specimen and mount the mold assembly on the jack platform in the compactor. Use spacers between the load spring assembly and follower to adjust the elevation of the mold assembly so the hammers strike near the center of the mass of material in the mold assembly.
8. Elevate the mold assembly with the jack until the load spring assembly seats on top of the follower and apply an initial seating load of approximately 100 lb<sub>f</sub> on the sample.
9. Start the compactor hammers. Continue to elevate the mold assembly, applying the load gradually over the time stated in the Table 3.

**Table 3**  
**Load Application Rate**

Load lb <sub>f</sub>	Time
0 to 500	1 min.
500 to 1,000	30 sec.
1,000 to 2,000	30 sec.

10. Upon reaching 2,000 lb<sub>f</sub> at the end of the 2-minute cycle, stop the hammer, release the load on the jack, and return to zero pressure.
11. Determine apparent moisture.
  - a. If the material is pumping around the mold follower or excessive amounts of water are seeping from between the mold and mold base, prepare a new sample and begin the test again at Step 1.
  - b. If the base of the mold is dry or there is a small amount of water, repeat Steps 7 through 10, four additional times.
12. Remove the mold assembly from the compactor.
13. Measure the height of the compacted specimen.
  - a. Lay the straight edge across the top of the mold assembly.

- b. Using the measuring device, measure from the bottom of the straight edge to the top of the follower and spacers to the nearest 0.1 mm (0.01 in.). Designate as D.
  - c. Calculate and record the height of the compacted specimen,  $h_s$ , by subtracting D and T (thickness of the follower) from the height of the mold  $h_m$ . See Annex A..
14. Determine and record the mass of the mold assembly and specimen,  $M_{ms}$ , to the nearest 5 g (0.01 lb.).
  15. Determine and record the mass of the specimen,  $M_s$ , by subtracting  $M_m$  from  $M_{ms}$ .
  16. Remove the specimen from the mold assembly.
  17. Use the entire specimen for a moisture content sample or obtain a representative sample by slicing vertically through the center of the specimen. Obtain at least 500 g (1.1 lb.) from one of the cut faces, ensuring that all the layers are represented. If a vertical face does not exist, take a representative sample.

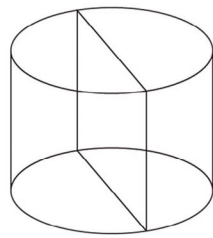

Slice through the center

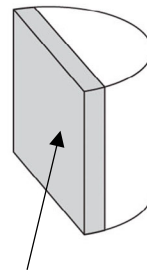

Representative moisture content sample

18. Determine and record the moisture content,  $w$ , according to the FOP for AASHTO T 255/T 265.
19. Calculate and record the wet density,  $\rho_w$ , of the fine aggregate portion.
20. Calculate and record the laboratory dry density,  $\rho_d$ , of the fine aggregate portion.

## Laboratory Maximum Dry Density of the Coarse Portion

### Vibratory Compactor Method

**Note 2:** Procedure 1 uses the small mold assembly, this procedure is not recommended for material with aggregate larger than 9.3 mm (3/4 in.).

#### Procedure 1

1. Determine and record the mass of the small mold assembly to the nearest 5 g (0.01 lb.). Designate this mass as the  $M_m$ .

2. Determine and record the mass of the coarse aggregate portion to the nearest 5 g (0.01 lb.). Designate this mass as the  $M_s$ . See Note 3.

*Note 3:* If all the coarse aggregate portion does not fit in the mold assembly or there is some indication that material may have been lost, perform alternate Step 16 to determine  $M_s$ .

3. Determine amount of water to add to the coarse aggregate portion by multiplying the mass determined in Step 2 by 0.025 (2.5 percent).
4. Add water to coarse aggregate portion, mix thoroughly.
5. Place approximately one third of the sample in the mold with mold base attached.
6. Tamp the surface lightly with the manually operated rammer to consolidate material and achieve a level surface.
7. Repeat Steps 5 and 6 for two subsequent lifts. Ensure all the coarse aggregate portion is placed in the mold.
8. Place the follower on top of the molded specimen and mount the mold assembly on the jack platform in the compactor. Use spacers between the load spring assembly and follower to adjust the elevation of the mold assembly so the hammers strike near the center of the mass of material in the mold assembly.
9. Elevate the mold assembly with the jack until the loading spring assembly seats on top of the follower and spacers.
10. Apply an initial seating load of approximately 100 lbf on the sample.
11. Start the compactor hammers. Continue to elevate the mold, applying the load gradually over the time stated in the Table 3.
12. Upon reaching the 2,000 lbf load at the end of the 2-minute cycle, stop the hammer, release the load on the jack, and return to zero pressure.
13. Repeat Steps 10 through 12 four additional times.
14. Remove the mold assembly from the compactor.
15. Measure the height of the compacted specimen.
  - a. Lay the straight edge across the top of the mold assembly.
  - b. Using the measuring device, measure from the bottom of the straight edge to the top of the follower and spacers to the nearest 0.1 mm (0.01 in.). Designate as  $D$ .
  - c. Calculate and record the height of the compacted specimen,  $h_s$ , by subtracting  $D$  and  $T$  (thickness of the follower) from the height of the mold  $h_m$ . See Annex A.

16. Alternate method of determining  $M_s$ 
  - a. Remove the specimen from the mold assembly.
  - b. Determine the dry mass according to the FOP for AASHTO T 255. Designate as  $M_s$ .
17. Calculate and record the laboratory dry density,  $\rho_d$ , of the coarse aggregate portion.

### Procedure 2

1. Determine and record the mass of the large mold assembly to the nearest 5 g (0.01 lb.). Designate this mass as the  $M_m$ .
2. Determine and record the mass of the coarse aggregate portion to the nearest 5 g (0.01 lb.). Designate this mass as the  $M_s$ .

**Note 4:** If all the coarse aggregate portion does not fit in the mold or there is some indication that material may have been lost, perform alternate Step 13 to determine  $M_s$ .

3. Place approximately one fifth of the sample in the large mold with mold base.
4. Tamp the surface lightly with the manually operated rammer to consolidate material and achieve a level surface.
5. Place the follower on top of the molded specimen and mount the mold assembly on the jack platform in the compactor. Use spacers between the load spring assembly and follower to adjust the elevation of the mold assembly so the hammers strike near the center of the mass of material in the mold assembly.
6. Elevate the mold assembly with the jack until the loading spring assembly seats on top of the follower.
7. Apply an initial seating load of approximately 100 lbf on the sample.
8. Start the compactor hammers. Continue to elevate the mold assembly, applying the load gradually over the time stated in the Table 3.
9. Upon reaching the 2,000 lbf load at the end of the 2-minute cycle, stop the hammer, release the load on the jack, and return to zero pressure.
10. Repeat Steps 3 through 9 four additional times. Ensure all the coarse aggregate portion is placed in the mold on the final lift.
11. Remove the mold assembly from the compactor.
12. Measure the height of the compacted specimen.
  - a. Lay the straight edge across the top of the mold assembly.

- b. Using the measuring device, measure from the bottom of the straight edge to the top of the follower and spacers to the nearest 0.1 mm (0.01 in.). Designate as D.
- c. Calculate and record the height of the compacted specimen,  $h_s$ , by subtracting D and T (thickness of follower) from the height of the mold,  $h_m$ . See Annex A.

13. Alternate method of determining  $M_s$

- a. Remove the specimen from the mold assembly.
- b. Determine the dry mass of the specimen according to the FOP for AASHTO T 255. Designate as  $M_s$ .

14. Calculate and record the laboratory dry density,  $\rho_d$ , of the coarse aggregate portion.

## Calculations

### Height of specimen in mold (fine or coarse aggregate portion)

$$h_s = h_m - D - T$$

where:

- $h_s$  = height of specimen in mold, 0.1 mm (0.01 in.)  
 $h_m$  = height of mold, 0.1 mm (0.01 in.), Annex A  
 D = measured distance from the mold top to the follower, 0.1 mm (0.01 in.)  
 T = thickness of the follower, 0.1 mm (0.01 in.), Annex A

### Volume of the specimen in the mold (fine or coarse aggregate portion)

$$V_s = \frac{h_s \times \pi \times \left(\frac{d}{2}\right)^2}{1e^9 \text{ mm}^3 / \text{m}^3 \text{ or } 1728 \text{ in}^3 / \text{ft}^3}$$

where:

- $V_s$  = volume of specimen in mold  $\text{m}^3$  ( $\text{ft}^3$ )  
 d = inside diameter of the mold, 0.1 mm (0.01 in.), Annex A

**Mass of fine aggregate portion in the mold assembly**

$$M_s = M_{ms} - M_m$$

where:

- $M_s$  = mass of specimen in mold assembly, 0.005 kg (0.01 lb.)  
 $M_{ms}$  = mass of mold assembly and specimen, 0.005 kg (0.01 lb.)  
 $M_m$  = mass of mold assembly, 0.005 kg (0.01 lb.)

**Wet Density of fine aggregate portion**

$$\rho_w = \frac{M_s}{V_s}$$

Where:

- $\rho_w$  = wet density, kg/m<sup>3</sup> (lb/ft<sup>3</sup>)  
 $M_s$  = mass of specimen in the mold assembly, 0.005 kg (0.01 lb.)  
 $V_s$  = volume of specimen in mold m<sup>3</sup> (ft<sup>3</sup>)

**Laboratory maximum dry density fine aggregate portion**

$$\rho_d = \left( \frac{\rho_w}{w + 100} \right) \times 100 \quad \text{or} \quad \rho_d = \frac{\rho_w}{\left( \frac{w}{100} \right) + 1}$$

Where:

- $\rho_d$  = dry density, kg/m<sup>3</sup> (lb/ft<sup>3</sup>)  
 $w$  = moisture content, as a percentage (FOP for AASHTO T 255)



**Laboratory maximum dry density of coarse aggregate portion**

$$\rho_d = \left( \frac{M_s}{V_s} \right) \times 100$$

Where:

$\rho_d$	=	dry density, kg/m <sup>3</sup> (lb/ft <sup>3</sup> )
$M_s$	=	mass of specimen in the mold assembly, 0.005 kg (0.01 lb.)
$V_s$	=	volume of specimen in mold m <sup>3</sup> (ft <sup>3</sup> )

**Example****Example for small mold fine aggregate portion**

Wet mass, $M_w$	=	6.470 kg (14.26 lb)
Moisture content, $w$	=	11.3%
Height of mold, $h_m$	=	203.7 mm (8.02 in.)
Inside diameter of mold, $d$	=	153.4 mm (6.04 in.)
Measurement from top of mold to follower, $D$	=	44.5 mm (1.75 in.)
Thickness of the follower, $T$	=	3.6 mm (0.14 in.)
Mass of specimen and mold assembly, $M_{ms}$	=	6.400 kg (14.11 lb)
Mass of mold assembly, $M_m$	=	0.280 kg (0.62 lb)

**Height of fine aggregate portion in mold**

$$h_s = h_m - D - T$$

$$h_s = 203.7 \text{ mm} - 44.5 \text{ mm} - 3.6 \text{ mm} = 155.6 \text{ mm}$$

$$h_s = 8.02 \text{ in.} - 1.75 \text{ in.} - 0.14 \text{ in.} = 6.13 \text{ in.}$$

**Volume of the fine aggregate in the mold**

$$V_s = \frac{h_s \times \pi \times \left(\frac{d}{2}\right)^2}{1e^9 \text{ mm}^3/\text{m}^3 \text{ or } 1728 \text{ in}^3/\text{ft}^3}$$

$$V_s = \frac{155.6 \text{ mm} \times \pi \times \left(\frac{153.4 \text{ mm}}{2}\right)^2}{1,000,000,000 \text{ mm}^3/\text{m}^3} = 0.002876 \text{ m}^3$$

Or

$$V_s = \frac{6.13 \text{ in.} \times \pi \times \left(\frac{6.04 \text{ in.}}{2}\right)^2}{1728 \text{ in}^3/\text{ft}^3} = 0.1016 \text{ ft}^3$$

**Mass of fine aggregate portion in the mold**

$$M_s = M_{ms} - M_m$$

$$M_s = 6.400 \text{ kg} - 0.280 \text{ kg} = 6.119 \text{ kg}$$

$$M_s = 14.11 \text{ lb} - 0.62 \text{ lb} = 13.49 \text{ lb}$$

**Wet density of fine aggregate portion**

$$\rho_w = \frac{M_s}{V_s}$$

$$\rho_w = \frac{6.119 \text{ kg}}{0.002876 \text{ m}^3} = 2128 \text{ kg/m}^3$$

$$\rho_w = \frac{13.49 \text{ lb}}{0.1016 \text{ ft}^3} = 132.8 \text{ lb/ft}^3$$

**Laboratory maximum dry density of the fine aggregate portion**

$$\rho_d = \left( \frac{\rho_w}{w + 100} \right) \times 100 \quad \text{or} \quad \rho_d = \frac{\rho_w}{\left( \frac{w}{100} \right) + 1}$$

$$\rho_d = \left( \frac{2128 \text{ kg/m}^3}{11.3\% + 100} \right) \times 100 = 1912 \text{ kg/m}^3 \quad \rho_d = \left( \frac{132.8 \text{ lb/ft}^3}{11.3\% + 100} \right) \times 100 = 119.3 \text{ lb/ft}^3$$

Or

$$\rho_d = \left( \frac{2128 \text{ kg/m}^3}{\frac{11.3\%}{100} + 1} \right) = 1912 \text{ kg/m}^3 \quad \rho_d = \left( \frac{132.8 \text{ lb/ft}^3}{\frac{11.3\%}{100} + 1} \right) = 119.3 \text{ lb/ft}^3$$

**Example for small mold coarse aggregate portion (Procedure 1)**

Calculations will be the same for Procedure 2

Height of mold assembly, $h_m$	=	203.7 mm (8.02 in.)
Inside diameter of mold, $d$	=	153.4 mm (6.04 in.)
Measurement from top of mold assembly to follower, $D$	=	42.4 mm (1.67 in.)
Thickness of the follower, $T$	=	3.6 mm (0.14 in.)
Mass of coarse aggregate in the mold assembly, $M_s$	=	4.985 kg (10.99 lb)

**Height of coarse aggregate portion in mold**

$$h_s = h_m - D - T$$

$$h_s = 203.7 \text{ mm} - 42.4 \text{ mm} - 3.6 \text{ mm} = 157.7 \text{ mm}$$

$$h_s = 8.02 \text{ in.} - 1.67 \text{ in.} - 0.14 \text{ in.} = 6.21 \text{ in.}$$

**Volume of the coarse aggregate portion in the mold**

$$V_s = \frac{h_s \times \pi \times \left(\frac{d}{2}\right)^2}{1e^9 \text{ mm}^3 / \text{m}^3 \text{ or } 1728 \text{ in}^3 / \text{ft}^3}$$

$$V_s = \frac{157.7 \text{ mm} \times \pi \times \left(\frac{153.4 \text{ mm}}{2}\right)^2}{1,000,000,000 \text{ mm}^3 / \text{m}^3} = 0.002915 \text{ m}^3$$

$$V_s = \frac{6.21 \text{ in.} \times \pi \times \left(\frac{6.04 \text{ in.}}{2}\right)^2}{1728 \text{ in}^3 / \text{ft}^3} = 0.1030 \text{ ft}^3$$

**Laboratory maximum dry density of coarse aggregate portion**

$$\rho_d = \left( \frac{M_s}{V_s} \right) \times 100$$

$$\rho_d = \left( \frac{4.985 \text{ kg}}{0.002915 \text{ m}^3} \right) \times 100 = 1710 \text{ kg/m}^3$$

$$\rho_d = \left( \frac{10.99 \text{ lb}}{0.1030 \text{ ft}^3} \right) \times 100 = 106.7 \text{ lb/ft}^3$$

**Theoretical Maximum Density Curve Development**

Enter the following data into an approved spreadsheet to develop the maximum density chart and maximum density curve.

- Laboratory maximum dry density,  $\rho_d$ , of the coarse aggregate portion to the nearest  $1 \text{ kg/m}^3$  ( $0.1 \text{ lb/ft}^3$ )
- Laboratory maximum dry density,  $\rho_d$ , of the fine aggregate portion to the nearest  $1 \text{ kg/m}^3$  ( $0.1 \text{ lb/ft}^3$ )
- Optimum moisture content to the nearest 0.1 percent if the FOP for AASTHO T 99/T 180, T 99 Method A was used for the fine portion.
- Coarse aggregate apparent specific gravity,  $G_{sa}$ , to the nearest 0.001
- Fine aggregate portion apparent specific gravity,  $G_{sa}$ , to the nearest 0.001

Example

Theoretical Maximum Dry Density Chart

Density Curves				Density Curves			
Pass #4	Maximum	Pass #4	Maximum	Pass #4	Maximum	Pass #4	Maximum
0.0	104.8	31.0	133.7	62.0	134.6	82.0	129.6
1.0	105.6	32.0	134.5	63.0	134.3	83.0	129.4
2.0	106.4	33.0	135.2	64.0	134.0	84.0	129.3
3.0	107.1	34.0	135.8	65.0	133.6	85.0	129.1
4.0	107.9	35.0	136.4	66.0	133.3	86.0	128.9
5.0	108.7	36.0	137.0	67.0	133.1	87.0	128.8
6.0	109.5	37.0	137.5	68.0	132.8	88.0	128.6
7.0	110.3	38.0	137.9	69.0	132.5	89.0	128.4
8.0	111.1	39.0	138.3	70.0	132.2	90.0	128.3
9.0	112.0	40.0	138.6	71.0	132.0	91.0	128.1
10.0	112.8	41.0	138.9	72.0	131.7	92.0	128.0
11.0	113.7	42.0	139.0	73.0	131.5	93.0	127.9
12.0	114.5	43.0	139.2	74.0	131.2	94.0	127.7
13.0	115.4	44.0	139.2	75.0	131.0	95.0	127.6
14.0	116.4	45.0	139.2	76.0	130.8	96.0	127.4
15.0	117.3	46.0	139.2	77.0	130.6	97.0	127.3
16.0	118.2	47.0	139.1	78.0	130.4	98.0	127.2
17.0	119.2	48.0	139.0	79.0	130.2	99.0	127.0
18.0	120.2	49.0	138.8	80.0	130.0	100.0	126.9
19.0	121.3	50.0	138.6	81.0	129.8		
20.0	122.3	51.0	138.3				
21.0	123.4	52.0	138.1				
22.0	124.5	53.0	137.8				
23.0	125.6	54.0	137.5				
24.0	126.8	55.0	137.1				
25.0	127.9	56.0	136.8				
26.0	129.0	57.0	136.4				
27.0	130.0	58.0	136.0				
28.0	131.0	59.0	135.7				
29.0	132.0	60.0	135.3				
30.0	132.8	61.0	135.0				

Control Points for Density Curves		
Pass #4	Maximum	Loose
0.0	104.8	87.6
20.5	122.8	99.6
27.4	130.4	103.8
42.5	139.1	105.4
61.1	134.9	96.7
100.0	126.9	81.9

### Theoretical Maximum Dry Density Curve

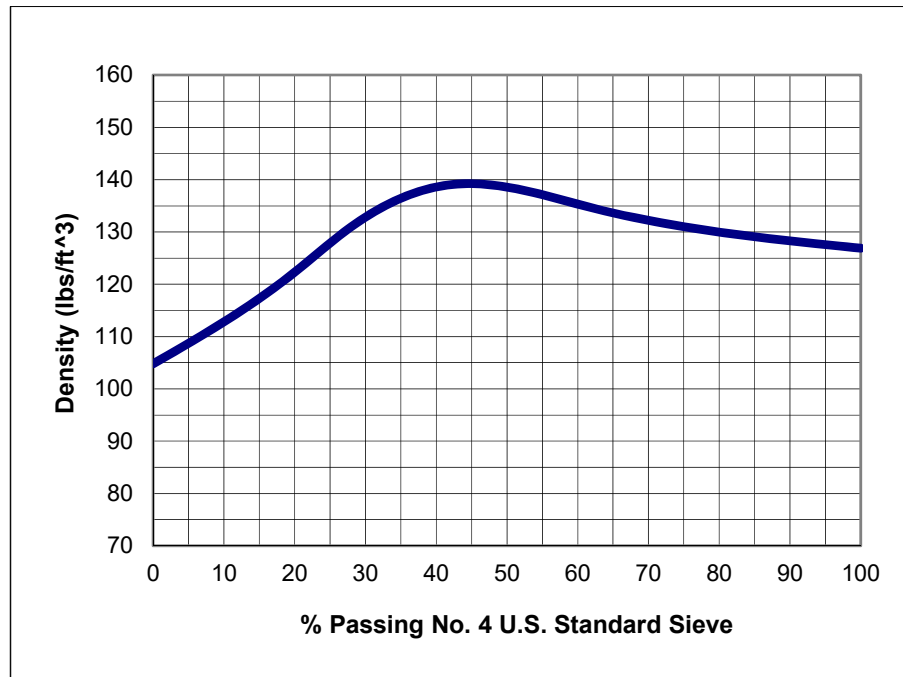

### Report

- Results on standard agency forms
- Sample ID
- Laboratory maximum dry density of the coarse aggregate portion to the nearest 1 kg/m<sup>3</sup> (0.1 lb/ft<sup>3</sup>)
- Laboratory maximum dry density of the fine aggregate portion to the nearest 1 kg/m<sup>3</sup> (0.1 lb/ft<sup>3</sup>)
- Optimum moisture content to the nearest 0.1 percent (when using the FOP for AASTHO T 99/T 180, T 99 Method A for the fine aggregate portion)
- Coarse aggregate apparent specific gravity ( $G_{sa}$ ) to the nearest 0.001
- Fine aggregate apparent specific gravity ( $G_{sa}$ ) to the nearest 0.001
- Theoretical maximum dry density chart
- Theoretical maximum dry density curve

---

**ANNEX A STANDARDIZATION OF THE MOLD ASSEMBLY**

(Mandatory Information)

**Apparatus**

- Calipers having a range sufficient to measure the diameter of the measure being checked and readable to at least 0.1 mm (0.01 in.)
- Inside diameter caliper, 300 mm (12 in.) range
- Straight edge at least 25 mm (1 in.) larger than the mold
- Ruler readable to 0.1 mm (0.01 in.)

**Procedure****Determine the height of the mold ( $h_m$ )**

1. Place the straight edge across the top of the mold with mold base.
2. Using the caliper measure from the bottom of the straight edge to the center mold with base to the nearest 0.1 mm (0.01 in.)
3. Turn the straight edge 90 degrees.
4. Repeat Step 2.
5. Average the two measurements.
6. Designate as  $h_m$

**Determine the thickness of the mold follower and spacers (T)**

1. Place follower and spacers inside the mold with mold base.
2. Place the straight edge across the top of the mold.
3. Using the caliper measure from the bottom of the straight edge to the center of the top of the follower to the nearest 0.1 mm (0.01 in.).
4. Turn the straight edge 90 degrees.
5. Repeat Step 3.
6. Average the two measurements.
7. Subtract the average measurement from  $h_m$
8. Designate as T.

**Determine the inside diameter of the mold (d)**

1. Using the caliper measure the inside diameter of the mold to the nearest 0.1 mm (0.01 in.).
2. Turn the mold 90 degrees.
3. Repeat Step 1.
4. Average the two measurements.
5. Designate as d.



---

## ANNEX B APPARENT SPECIFIC GRAVITY ( $G_{sb}$ ) DETERMINATION

(Mandatory Information)

This procedure covers the determination of apparent specific of coarse and fine aggregate by means of a pycnometer. When the soil is composed of material both larger and smaller than the 4.75 mm (No. 4) sieve, the sample is separated on the 4.75 mm (No. 4) sieve.

### Apparatus

- Pycnometer: A flask or other suitable container in which the volume can be reproduced within  $\pm 0.1$  ml. The volume of the flask shall be at least 50 percent greater than required for the test sample.
- Pycnometer / volumetric flask cover: A glass plate or a metal or plastic cover with a vented opening
- Balance: A balance of sufficient capacity, readable to 0.1 g. Meeting AASHTO M 231, Class G2.
- Oven: Capable of maintaining a temperature of  $110 \pm 5^\circ\text{C}$  ( $230 \pm 9^\circ\text{F}$ ) for drying the specimens to a constant mass.
- Vacuum lid: A transparent lid with a suitable vacuum connection, with a vacuum opening to be covered with a fine wire mesh
- Vacuum: Capable of evacuating air from the container to a partial vacuum of 13.33 kPa (100 mmHg) or less absolute pressure
- Manometer or vacuum gauge: Capable of measuring the vacuum being applied at the source of the vacuum
- Water bath: A constant-temperature water bath (optional)
- Thermometers: Thermometric devices accurate to  $0.5^\circ\text{C}$  ( $1^\circ\text{F}$ )
- Bleeder valve to adjust vacuum
- Timer

### Sample Preparation

1. Sample and reduce the aggregate in accordance with the FOPs for AASHTO R 90 and R 76.
2. Dry the sample sufficiently to obtain a clean separation of fine and coarse material in the sieving operation.
3. Sieve the sample in accordance with the FOP for AASHTO T 27/ T 11 over the 4.75 mm (No. 4) sieve.

**Coarse test sample**

- a. Split or quarter approximately 1000 g of material from the portion retained on the 4.75 mm (No. 4) sieve.
- b. Dry to constant mass according to the FOP for AASHTO T 255 at  $110 \pm 5^{\circ}\text{C}$  ( $230 \pm 9^{\circ}\text{F}$ ).
- c. Cool to room temperature.

**Fine test sample**

- a. Split or quarter approximately 500 g of material from the portion passing the 4.75 mm (No. 4) sieve.
- b. Dry to constant mass according to the FOP for AASHTO T 255/T 265 at  $110 \pm 5^{\circ}\text{C}$  ( $230 \pm 9^{\circ}\text{F}$ ).
- c. Cool to room temperature.

**Procedure**

The procedure is performed on fine and coarse aggregate separately.

1. Determine and record the mass of the dry test sample. Designate as A.
2. Place the test sample in the pycnometer.
3. Add water at approximately  $20^{\circ}\text{C}$  ( $68^{\circ}\text{F}$ ) until the pycnometer is about  $\frac{3}{4}$  full.
4. Connect the pycnometer to the vacuum system.
5. Apply partial vacuum, 30 mmHg or less absolute pressure, for  $20 \pm 1$  min.
6. Agitate the pycnometer and contents, either continuously by mechanical device or manually by vigorous shaking, at 2-minute intervals. This agitation facilitates the removal of entrapped air.
7. Release vacuum and disconnect the hoses.
8. Fill the pycnometer with water without reintroducing air. Water temperature should be maintained as close to  $20 \pm 0.5^{\circ}\text{C}$  ( $68 \pm 1^{\circ}\text{F}$ ) as possible throughout the procedure.

**Note 1:** It may be necessary to place the pycnometer in a water bath for 10 minutes after the release of vacuum to stabilize at  $20 \pm 0.5^{\circ}\text{C}$  ( $68 \pm 1^{\circ}\text{F}$ ).

- a. Metal pycnometer (coarse test sample only) – Fill the pycnometer with  $20 \pm 0.5^{\circ}\text{C}$  ( $68 \pm 1^{\circ}\text{F}$ ) water according to manufacturer's instructions and dry the outside.
  - b. Glass pycnometer (fine or coarse test samples) – Completely fill the pycnometer with  $20 \pm 0.5^{\circ}\text{C}$  ( $68 \pm 1^{\circ}\text{F}$ ) water, slide the calibrated glass plate over the mouth of the pycnometer making sure there are no air bubbles trapped under the plate. Dry the outside.
9. Determine and record the mass of the pycnometer, sample, and water. Designate as C.

**Calculation**

Calculate the  $G_{sa}$  to three decimal places as follows:

$$G_{sa} = \frac{A}{A + B - C}$$

Where:

- A = Mass of dry sample in air, g
- B = Mass of pycnometer filled with water at 20°C (68°F), g, determined during the Standardization of Pycnometer procedure
- C = Mass of pycnometer, water, and the test sample at to 20 ±0.5°C (68 ±1°F), g

**Coarse example:**

$$G_{sa} = \frac{2200.3 \text{ g}}{2200.3 \text{ g} + 7502.5 \text{ g} - 8812.0 \text{ g}} = 2.470$$

Given:

- A = 2200.3 g
- B = 7502.5 g
- C = 8812.0 g

**Report**

- Report on standard agency forms.
- Report apparent specific gravities,  $G_{sa}$ , to the nearest 0.001

## Standardization of Pycnometer

The pycnometer shall be standardized periodically in conformance with procedures established by the agency.

1. Fill the pycnometer with water at approximately 20°C (68°F).
2. Place the metal or plastic cover, or a glass plate on the pycnometer and eliminate all air.

**Note B1:** When using a metal pycnometer and cover, place the cover on the pycnometer and push down slowly, forcing excess water out of the hole in the center of the cover. Use care when filling the pycnometer to avoid reintroducing air into the water.

3. Stabilize the pycnometer at  $20 \pm 0.5^\circ\text{C}$  ( $68 \pm 1^\circ\text{F}$ ) for  $10 \pm 1$  min.
4. Towel dry the outside of the pycnometer and cover.
5. Determine and record the mass of the pycnometer, water, and lid.
6. Repeat Steps 2 through 5 two more times for a total of three determinations.
7. If the variation of the three masses is within 0.3 g, average the three masses. Designate as “B.”
8. If the variation of the masses is greater than 0.3 g, take corrective action and perform the “Standardization of Pycnometer” again.

## Performance Exam Checklist

### WAQTC TM 15

#### *Laboratory Theoretical Maximum Dry Density of Granular Soil and Soil/Aggregate*

Participant Name: \_\_\_\_\_ Exam Date: \_\_\_\_\_

Record the symbols “P” for passing or “F” for failing on each step of the checklist.

<b>Procedure Element</b>	<b>Trial 1</b>	<b>Trial 2</b>
1. The tester has a copy of the current procedure on hand?	_____	_____
2. All equipment is functioning according to the test procedure, and if required has the current calibration/standardization/check and maintenance tags present?	_____	_____
<b>Sample Preparation Element</b>		
3. A minimum of 180 kg. (400 lbs.) representative sample material obtained according to FOP for AASHTO R 90?	_____	_____
4. Representative sample reduced according to FOP for AASHTO R 76 to yield the sample sizes for testing?	_____	_____
5. If damp, sample dried at a temperature not exceeding 60°C (140°F)?	_____	_____
6. Material retained on the 75 mm (3 in.) sieve removed?	_____	_____
7. Coarse and fine aggregate portions separated through the 4.75 mm (No. 4) sieve?	_____	_____
<b>Fine Aggregate Portion Element</b>		
8. Proper test method selected based on Table 1?	_____	_____
9. Mass of clean dry small mold determined to the nearest 5 g (0.01 lb.)?	_____	_____
10. Enough water added to saturate sample and mixed until homogenous?	_____	_____
11. Each lift consolidated with 25 strokes of tamping rod and 25 blows of manually operated rammer?	_____	_____
12. Top lift finished as level as possible?	_____	_____
13. Mold cap placed and spacers utilized so the hammers strike near the center of mass in the mold?	_____	_____
14. Initial seating load of approximately 100 lbf applied?	_____	_____
15. Compaction begun and load application rate per Table 3 followed?	_____	_____
16. Based on the determination of apparent moisture, compaction cycle repeated four additional times or a new sample is prepared and test restarted from Step 1.?	_____	_____
17. Height of compacted specimen determined and recorded?	_____	_____
18. Mass of specimen determined and recorded?	_____	_____
19. Moisture content determined and recorded?	_____	_____
20. Dry density determined?	_____	_____

Procedure Element	Trial 1	Trial 2
<b>Coarse Aggregate Portion Element</b>		
21. Proper test method selected based on Table 2?	_____	_____
<b>Procedure 1 Element</b>		
22. Mass of clean dry small mold determined to the nearest 5 g (0.01 lb.)?	_____	_____
23. Mass of coarse aggregate portion (Ms) determined to the nearest 5 g (0.01 lb.)?	_____	_____
24. Coarse aggregate mass multiplied by 0.025 to determine mass of water to be added?	_____	_____
25. Water and coarse aggregate mixed thoroughly?	_____	_____
26. Each lift tamped lightly with manually operated rammer?	_____	_____
27. Mold cap placed and spacers utilized so the hammers strike near the center of mass in the mold?	_____	_____
28. Initial seating load of approximately 100 lbf applied?	_____	_____
29. Compaction begun and load application rate per Table 3 followed?	_____	_____
30. Compaction cycle repeated four additional times?	_____	_____
31. Height of compacted specimen determined and recorded?	_____	_____
32. If all the coarse aggregate did not fit into the mold the alternate method of determining Ms followed?	_____	_____
33. Dry density determined?	_____	_____
<b>Procedure 2 Element</b>		
34. Mass of clean dry large mold determined to the nearest 5 g (0.01 lb.)?	_____	_____
35. Mass of coarse aggregate portion (Ms) determined to the nearest 5 g (0.01 lb.)?	_____	_____
36. Approximately one fifth of the sample place in mold?	_____	_____
37. Lift tamped lightly with manually operated rammer to consolidate and level?	_____	_____
38. Mold cap placed and spacers utilized so the hammers strike near the center of mass in the mold?	_____	_____
39. Initial seating load of approximately 100 lbf applied?	_____	_____
40. Compaction begun and load application rate per Table 3 followed?	_____	_____
41. Aggregate placement and compaction cycle repeated four additional times?	_____	_____
42. Height of compacted specimen determined and recorded?	_____	_____
43. If all the coarse aggregate did not fit into the mold the alternate method of determining Ms followed?	_____	_____
44. Dry density determined?	_____	_____

Procedure Element	Trial 1	Trial 2
<b>Apparent Specific Gravity of the Fine and Coarse Portions According to Annex B</b>		
45. Appropriate amount of coarse and fine aggregate portions obtained, dried, and cooled?	_____	_____
46. Mass of dry test sample(s) determined and recorded?	_____	_____
47. Test sample(s) placed in pycnometer and 20°C (68°F) water added to about ¾ full?	_____	_____
48. Partial vacuum applied to pycnometer and contents for 20 ± 1 min. and agitated by mechanical device or manually?	_____	_____
49. Vacuum released and pycnometer filled with water without reintroducing air?	_____	_____
50. Water stabilized at 20 ±0.5°C (68 ±1°F), pycnometer cover positioned, and outside dried?	_____	_____
51. Mass of pycnometer, sample, and water determined and recorded?	_____	_____
52. Specific Gravity determined?	_____	_____

Comments: First Attempt: Pass \_\_\_\_\_ Fail \_\_\_\_\_ Second Attempt: Pass \_\_\_\_\_ Fail \_\_\_\_\_

Examiner Signature: \_\_\_\_\_ WAQTC #: \_\_\_\_\_





## Performance Exam Checklist

### AASHTO T 19M/T 19

#### *Bulk Density (“Unit Weight”) and Voids in Aggregate (Rodding Procedure Only)*

WSDOT has adopted AASHTO T 19.

Participant Name: \_\_\_\_\_ Exam Date: \_\_\_\_\_

Procedure Element

Trial 1 Trial 2

Record the symbols "P" for passing or "F" for failing on each step of the checklist.

1. The tester has a copy of the current procedure on hand?
2. All equipment is functioning according to the test procedure, and if required, has the current calibration/verification tags present?
3. Sample is approximately 125 to 200 percent of quantity required to fill measure?
4. Sample is handled correctly to avoid segregation?
5. Sample is dried in accordance with WSDOT FOP for AASHTO T 255?

Rodding Procedure

6. Mass of empty unit weight measure is determined and recorded (nearest 0.1 lb)?
7. Measure is filled in three equal layers?
8. Each layer is rodded throughout it's depth 25 times with a hemispherical end of rod but rodding does not penetrating into the next layer?
9. Rodding is evenly distributed over the surface of the sample?
10. Mass of unit weight measure plus contents is determined to the nearest 0.1 lb and recorded?
11. All calculations performed correctly?
12. Bulk density reported to the nearest 1 lb/ft<sup>3</sup>?

Comments: First Attempt: Pass \_\_\_\_\_ Fail \_\_\_\_\_ Second Attempt: Pass \_\_\_\_\_ Fail \_\_\_\_\_

Examiner Signature: \_\_\_\_\_ WAQTC #: \_\_\_\_\_

# WSDOT FOP for AASHTO T 22

## *Compressive Strength of Cylindrical Concrete Specimens*

WSDOT has adopted the published AASHTO T 22 with errata's below.

*AASHTO Test Methods cannot be included in Materials Manual due to copyright infringement.*

*WSDOT employees can access AASHTO and ASTM test methods in the following web address:*

[wwwi.wsdot.wa.gov/tools-services/library-services/access-aashto-publications-and-astm-aci-or-sspc-standards](http://wwwi.wsdot.wa.gov/tools-services/library-services/access-aashto-publications-and-astm-aci-or-sspc-standards)

*Non-WSDOT employees can order AASHTO's Standard Specifications for Transportation Materials and Methods of Sampling and Testing, using the following web address: <https://store.transportation.org>*

### 5. Significance and Use

5.2. *Include Note below.*

**Note:** Testing for determining compressive strength of cylinder specimens shall require a set of two specimens made from the same sample.

### 7. Specimens

6.3. *Step not recognized by WSDOT.*

6.4. *Determine specimen mass and length as described below.*

Remove any surface moisture with a towel and measure the mass of the specimen using a balance or scale that is accurate to within 0.3 percent of the mass being measured. Measure the length of the specimen to the nearest 1 mm (0.05 in.) at three locations spaced evenly around the circumference. Compute the average length and record to the nearest 1 mm (0.05 in.).

### 8. Procedure

8.3. *Include Note below.*

**Note:** The 28-day compressive break may be extended by up to 48 hours if the scheduled 28-day break falls on a Saturday, Sunday, or Holiday. The Regional Materials Engineer must authorize the time extension in writing.

### 10. Report

10.1. *Include Note below.*

**Note:** The report shall also include specimen mass and length as determined in 7.4..



## Performance Exam Checklist

### AASHTO T 22

#### *Compressive Strength of Cylindrical Concrete Specimens*

Participant Name: \_\_\_\_\_ Exam Date: \_\_\_\_\_

Record the symbols "P" for passing or "F" for failing on each step of the checklist.

Procedure Element	Trial 1	Trial 2
1. The tester has a copy of the current procedure on hand?	_____	_____
2. All equipment is functioning according to the test procedure, and if required has the current calibration/standardization/check and maintenance tags present?	_____	_____
3. Specimens kept moist between removal from moist storage and testing?	_____	_____
4. Diameter of the cylinder recorded to the nearest 0.01 inch by averaging two diameters taken at about mid-height?	_____	_____
5. Specimen not tested if individual diameter readings differ more than 2 percent?	_____	_____
6. Ends of specimen checked for perpendicularity to the axis?	_____	_____
7. Specimen mass and length recorded?	_____	_____
8. Ends of specimen checked for plane?	_____	_____
9. If ends not plane, specimen sawed or ground to meet tolerance or capped in accordance to either AASHTO T 231 or ASTM C1231? (Refer to AASHTO T 231 or ASTM C1231 procedure and checklist if used)	_____	_____
10. Bearing faces wiped clean?	_____	_____
11. Load indicator set to zero?	_____	_____
12. Spherical seated block parallel to top of specimen prior to applying load?	_____	_____
13. If using Unbonded Caps, alignment of specimen checked after application of load but before reaching 10 percent of anticipated load strength?	_____	_____
14. Load applied continuously and without shock?	_____	_____
15. The designated load rate maintained at least during the latter half of anticipated load strength?	_____	_____
16. No adjustment to load rate as ultimate load is being approached?	_____	_____
17. Compressive load continued until tester is certain ultimate capacity has been attained?	_____	_____
18. Maximum load and type of fracture recorded?	_____	_____
19. Specimens broken within permissible time tolerances?	_____	_____
20. All calculations performed correctly?	_____	_____

Comments: First Attempt: Pass \_\_\_\_\_ Fail \_\_\_\_\_ Second Attempt: Pass \_\_\_\_\_ Fail \_\_\_\_\_

Examiner Signature: \_\_\_\_\_ WAQTC #: \_\_\_\_\_

# WSDOT Errata to FOP for AASHTO T 27\_T 11

## Sieve Analysis of Fine and Coarse Aggregates

WAQTC FOP for AASHTO T 27\_T 11 has been adopted by WSDOT with the following changes:

**Procedure Method C** – *Method not recognized by WSDOT.*

### Sample Preparation

**Table 1 Test Sample Sizes for Aggregate Gradation Test** – *Shall conform to the following table and nominal maximum size definition.*

Nominal Maximum Size*in (mm)		Minimum Dry Mass lb (kg)	
US No. 4	(4.75)	1	(0.5)
¼	(6.3)	2	(1)
⅜	(9.5)	2	(1)
½	(12.5)	5	(2)
⅝	(16.0)	5	(2)
¾	(19.0)	7	(3)
1	(25.0)	13	(6)
1¼	(31.5)	17	(7.5)
1½	(37.5)	20	(9)
2	(50)	22	(10)
2½	(63)	27	(12)
3	(75)	33	(15)
3½	(90)	44	(20)

\*For Aggregate, the nominal maximum size sieve is the largest standard sieve opening listed in the applicable specification upon which more than 1-percent of the material by weight is permitted to be retained. For concrete aggregate, the nominal maximum size sieve is the smallest standard sieve opening through which the entire amount of aggregate is permitted to pass.





**SIEVE ANALYSIS OF FINE AND COARSE AGGREGATES  
FOP FOR AASHTO T 27  
MATERIALS FINER THAN 75  $\mu\text{m}$  (NO. 200) SIEVE IN MINERAL AGGREGATE  
BY WASHING  
FOP FOR AASHTO T 11**

### Scope

A sieve analysis, or ‘gradation,’ measures distribution of aggregate particle sizes within a given sample.

Accurate determination of the amount of material smaller than 75  $\mu\text{m}$  (No. 200) cannot be made using just AASHTO T 27. If quantifying this material is required, use AASHTO T 11 in conjunction with AASHTO T 27.

This FOP covers sieve analysis in accordance with AASHTO T 27-24 and materials finer than 75  $\mu\text{m}$  (No. 200) in accordance with AASHTO T 11-24 performed in conjunction with AASHTO T 27. The procedure includes three methods: A, B, and C.

### Apparatus

- Balance or scale: Capacity sufficient for the masses shown in Table 1, readable to 0.1 g, and meeting the requirements of AASHTO M 231
- Sieves: Meeting the requirements of ASTM E11
- Mechanical sieve shaker: Meeting the requirements of AASHTO T 27

**Note 1:** Sieves with a large sieving area, greater than 304.8 mm (12 in.) diameter may not be practical for all sizes of samples. The large sieving area needed for practical sieving of a large nominal size coarse aggregate could result in loss of a portion of the sample if used for a smaller sample of coarse aggregate or fine aggregate affecting final test results.

- Suitable drying equipment (refer to FOP for AASHTO T 255)
- Containers: A pan or vessel of sufficient size to contain the sample covered with water and permit vigorous agitation without loss of material or water
- Optional
  - Utensil: device for agitating the sample during the washing procedure.
  - Mechanical washing device
  - Mallet: With a rubber or rawhide head having a mass of  $0.57 \pm 0.23$  kg ( $1.25 \pm 0.5$  lb)
  - Wetting Agent: A dispersing agent that will promote separation of the fine materials without degrading the aggregate. Any detergent used shall not leave a residue on the sample during the washing procedure.

### Sample Sieving

- In all procedures, the sample is shaken in nested sieves. Sieves are selected to furnish information required by specification. Intermediate sieves are added for additional information or to avoid overloading sieves, or both.
- The sieves are nested in order of increasing size from the bottom to the top, and the sample, or a portion of the sample, is placed on the top sieve.
- The loaded sieves are shaken in a mechanical shaker for approximately 10 minutes, refer to Annex A, *Time Evaluation*.
- Care must be taken so that sieves are not overloaded, refer to Annex B, *Overload Determination*. The sample may be sieved in increments and the mass retained for each sieve added together from each sample increment to avoid overloading sieves.

### Sample Preparation

Obtain samples according to the FOP for AASHTO R 90 and reduce to sample size, shown in Table 1, according to the FOP for AASHTO R 76.

**TABLE 1**  
**Sample Sizes for Aggregate Gradation Test**

Nominal Maximum Size* mm (in.)	Minimum Dry Mass g (lb)
125 (5)	300,000 (660)
100 (4)	150,000 (330)
90 (3 1/2)	100,000 (220)
75 (3)	60,000 (130)
63 (2 1/2)	35,000 (77)
50 (2)	20,000 (44)
37.5 (1 1/2)	15,000 (33)
25.0 (1)	10,000 (22)
19.0 (3/4)	5000 (11)
12.5 (1/2)	2000 (4)
9.5 (3/8)	1000 (2)
6.3 (1/4)	1000 (2)
4.75 (No. 4)	500 (1)

\*Nominal maximum size: One sieve larger than the first sieve to retain more than 10 percent of the material using an agency specified set of sieves based on cumulative percent retained. Where large gaps between specification sieves exist, intermediate sieve(s) may be inserted to determine nominal maximum size.

Sample sizes in Table 1 are standard for aggregate sieve analysis, due to equipment restraints samples may need to be divided into several “subsamples.” For example, a gradation that requires 100 kg (220 lbs.) of material would not fit into a large tray shaker all at once.

Some agencies permit reduced sample sizes if it is proven that doing so is not detrimental to the test results. Some agencies require larger sample sizes. Check agency guidelines for required or permitted sample sizes.

### **Selection of Procedure**

Agencies may specify which method to perform. If a method is not specified, perform Method A.

### **Overview**

#### **Method A**

- Determine original dry mass of the sample
- Wash over a 75µm (No. 200) sieve
- Determine dry mass of washed sample
- Sieve washed sample
- Calculate and report percent retained and passing each sieve

#### **Method B**

- Determine original dry mass of the sample
- Wash over a 75 µm (No. 200) sieve
- Determine dry mass of washed sample
- Sieve sample through coarse sieves, 4.75 mm (No. 4) sieves and larger
- Determine mass of fine material, minus 4.75 mm (No. 4)
- Reduce fine material
- Determine mass of reduced portion
- Sieve reduced portion
- Calculate and report percent retained and passing each sieve

#### **Method C**

- Determine original dry mass of the sample
- Sieve sample through coarse sieves, 4.75 mm (No. 4) sieves and larger
- Determine mass of fine material, minus 4.75 mm (No. 4)
- Reduce fine material
- Determine mass of reduced portion
- Wash reduced portion over a 75µm (No. 200) sieve

- Determine dry mass of washed reduced portion
- Sieve washed reduced portion
- Calculate and report percent retained and passing each sieve

### Procedure Method A

1. Dry the sample to constant mass according to the FOP for AASHTO T 255. Cool to room temperature.
2. Determine and record the original dry mass of the sample to the nearest 0.1 g. Designate this mass as *M*.

When the specification does not require the amount of material finer than 75  $\mu\text{m}$  (No. 200) be determined by washing, skip to Step 11.

3. Nest a sieve, such as a 2.0 mm (No. 10), above the 75  $\mu\text{m}$  (No. 200) sieve.
4. Place the sample in a container and cover with water.

**Note 2:** When required by the agency, add a detergent, dispersing solution, or other wetting agent to the water to assure a thorough separation of the material finer than the 75  $\mu\text{m}$  (No. 200) sieve from the coarser particles. There should be enough wetting agent to produce a small amount of suds when the sample is agitated. Excessive suds may overflow the sieves and carry material away with them.

5. Agitate vigorously to ensure complete separation of the material finer than 75  $\mu\text{m}$  (No. 200) from coarser particles and bring the fine material into suspension above the coarser material. To aid in the agitation process, a utensil may be used. To avoid degradation of the sample when using a mechanical washing device do not exceed 10 minutes.
6. Immediately pour the wash water containing the suspended material over the nested sieves; be careful not to pour out the coarser particles or over fill the 75  $\mu\text{m}$  (No. 200) sieve.
7. Add water to cover material remaining in the container and repeat Step 5. Continue until the wash water is reasonably clear. Rinse utensil, if used, into the washed sample.
8. Remove the upper sieve and return material retained to the washed sample.
9. Rinse the material retained on the 75  $\mu\text{m}$  (No. 200) sieve until water passing through the sieve is reasonably clear and detergent or dispersing agent is removed, if used.
10. Return all material retained on the 75  $\mu\text{m}$  (No. 200) sieve to the container by rinsing into the washed sample.

**Note 3:** Excess water may be carefully removed with a bulb syringe; the removed water must be discharged back over the 75  $\mu\text{m}$  (No. 200) sieve to prevent loss of fines.

11. Dry the washed sample to constant mass according to the FOP for AASHTO T 255. Cool to room temperature.
12. Determine and record the dry mass of the sample.
13. Select sieves required by the specification and those necessary to avoid overloading as described in Annex B. With a pan on bottom, nest the sieves increasing in size starting with the 75  $\mu\text{m}$  (No. 200).

14. Place the sample, or a portion of the sample, on the top sieve. Sieves may already be in the mechanical shaker, if not place sieves in mechanical shaker and shake for the minimum time determined to provide complete separation for the sieve shaker being used (approximately 10 minutes, the time determined by Annex A).

**Note 4:** Excessive shaking (more than 10 minutes) may result in degradation of the sample.

15. Determine and record the individual or cumulative mass retained for each sieve and in the pan. Ensure that all material trapped in full openings of the sieve are removed and included in the mass retained.

**Note 5:** For sieves 4.75 mm (No. 4) and larger, check material trapped in less than a full opening by sieving over a full opening. Use coarse wire brushes to clean the 600 µm (No. 30) and larger sieves, and soft bristle brushes for smaller sieves.

**Note 6:** In the case of coarse / fine aggregate mixtures, distribute the minus 4.75 mm (No. 4) among two or more sets of sieves to prevent overloading of individual sieves.

16. Perform the *Check Sum* calculation – Verify the *total mass after sieving* compared to the *dry mass before sieving* is not more than 0.3 percent. The *dry mass before sieving* is the dry mass after wash or the original dry mass (*M*) if performing the sieve analysis without washing. Do not use test results for acceptance if the *Check Sum* result is more than 0.3 percent.

17. Calculate the total percentages passing, and the individual or cumulative percentages retained to the nearest 0.1 percent by dividing the individual sieve masses or cumulative sieve masses by the original dry mass (*M*) of the sample.

18. Report total percent passing to 1 percent except report the 75 µm (No. 200) sieve to 0.1 percent.

## Method A Calculations

### Check Sum

$$\text{Check Sum} = \frac{\text{dry mass before sieving} - \text{total mass after sieving}}{\text{dry mass before sieving}} \times 100$$

AGGREGATE

WAQTC

FOP AASHTO T 27 / T 11 (24)

**Percent Retained**

$$IPR = \frac{IMR}{M} \times 100 \quad \text{or} \quad CPR = \frac{CMR}{M} \times 100$$

Where:

IPR	=	Individual Percent Retained
CPR	=	Cumulative Percent Retained
M	=	Original dry mass of the sample
IMR	=	Individual Mass Retained
CMR	=	Cumulative Mass Retained

**Percent Passing (PP)**

$$PP = PPP - IPR \quad \text{or} \quad PP = 100 - CPR$$

Where:

PP	=	Percent Passing
PPP	=	Previous Percent Passing

**Method A Example Individual Mass Retained**

Original dry mass of the sample ( <i>M</i> ):	5168.7 g
Dry mass of the sample after washing:	4911.3 g
Total mass after sieving equals	
Sum of Individual Masses Retained (IMR), including minus 75 μm (No. 200) in the pan:	4905.9 g
Amount of 75 μm (No. 200) minus washed out (5168.7 g – 4911.3 g):	257.4 g

**Check Sum**

$$\text{Check Sum} = \frac{4911.3 \text{ g} - 4905.9 \text{ g}}{4911.3 \text{ g}} \times 100 = 0.1\%$$

The result is not more than 0.3 percent therefore the results can be used for acceptance purposes.

AGGREGATE

WAQTC

FOP AASHTO T 27 / T 11 (24)

**Individual Percent Retained (IPR) for 9.5 mm (3/8 in.) sieve:**

$$IPR = \frac{619.2 \text{ g}}{5168.7 \text{ g}} \times 100 = 12.0\%$$

**Percent Passing (PP) 9.5 mm (3/8 in.) sieve:**

$$PP = 86.0\% - 12.0\% = 74.0\%$$

**Reported Percent Passing = 74%**

**Method A Individual  
Gradation on All Sieves**

Sieve Size mm (in.)	Individual Mass Retained g (IMR)	Determine IPR by dividing IMR by <i>M</i> and multiplying by 100	Individual Percent Retained (IPR)	Determine PP by subtracting IPR from previous PP	Percent Passing (PP)	Reported Percent Passing*
19.0 (3/4)	0		0		100.0	100
12.5 (1/2)	724.7	$\frac{724.7}{5168.7} \times 100 =$	14.0	$100.0 - 14.0 =$	86.0	86
9.5 (3/8)	619.2	$\frac{619.2}{5168.7} \times 100 =$	12.0	$86.0 - 12.0 =$	74.0	74
4.75 (No. 4)	1189.8	$\frac{1189.8}{5168.7} \times 100 =$	23.0	$74.0 - 23.0 =$	51.0	51
2.36 (No. 8)	877.6	$\frac{877.6}{5168.7} \times 100 =$	17.0	$51.0 - 17.0 =$	34.0	34
1.18 (No. 16)	574.8	$\frac{574.8}{5168.7} \times 100 =$	11.1	$34.0 - 11.1 =$	22.9	23
0.600 (No. 30)	329.8	$\frac{329.8}{5168.7} \times 100 =$	6.4	$22.9 - 6.4 =$	16.5	17
0.300 (No. 50)	228.5	$\frac{228.5}{5168.7} \times 100 =$	4.4	$16.5 - 4.4 =$	12.1	12
0.150 (No. 100)	205.7	$\frac{205.7}{5168.7} \times 100 =$	4.0	$12.1 - 4.0 =$	8.1	8
0.075 (No. 200)	135.4	$\frac{135.7}{5168.7} \times 100 =$	2.6	$8.1 - 2.6 =$	5.5	5.5
minus 0.075 (No. 200) in the pan	20.4					
Total mass after sieving = sum of sieves + mass in the pan = 4905.9 g						
Original dry mass of the sample ( <i>M</i> ): 5168.7g						

\* Report total percent passing to 1 percent except report the 75 μm (No. 200) sieve to 0.1 percent.



AGGREGATE

WAQTC

FOP AASHTO T 27 / T 11 (24)

**Method A Example Cumulative Mass Retained**

Original dry mass of the sample ( <i>M</i> ):	5168.7 g
Dry mass of the sample after washing:	4911.3 g
Total mass after sieving equals Final Cumulative Mass Retained (FCMR) (includes minus 75 μm (No. 200) from the pan):	4905.9 g
Amount of 75μm (No. 200) minus washed out (5168.7 g – 4911.3 g):	257.4 g

**Check Sum**

$$\text{Check Sum} = \frac{4911.3 \text{ g} - 4905.9 \text{ g}}{4911.3 \text{ g}} \times 100 = 0.1\%$$

The result is not more than 0.3 percent therefore the results can be used for acceptance purposes.

**Cumulative Percent Retained (CPR) for 9.5 mm (3/8 in.) sieve:**

$$\text{CPR} = \frac{1343.9 \text{ g}}{5168.7 \text{ g}} \times 100 = 26.0\%$$

**Percent Passing (PP) 9.5 mm (3/8 in.) sieve:**

$$\text{PP} = 100.0\% - 26.0\% = 74.0\%$$

**Reported Percent Passing = 74%**

**Method A Cumulative  
Gradation on All Sieves**

Sieve Size mm (in.)	Cumulative Mass Retained g (CMR)	Determine CPR by dividing CMR by M and multiplying by 100	Cumulative Percent Retained (CPR)	Determine PP by subtracting CPR from 100.0	Percent Passing (PP)	Reported Percent Passing*
19.0 (3/4)	0		0.0		100.0	100
12.5 (1/2)	724.7	$\frac{724.7}{5168.7} \times 100 =$	14.0	$100.0 - 14.0 =$	86.0	86
9.5 (3/8)	1343.9	$\frac{1343.9}{5168.7} \times 100 =$	26.0	$100.0 - 26.0 =$	74.0	74
4.75 (No. 4)	2533.7	$\frac{2533.7}{5168.7} \times 100 =$	49.0	$100.0 - 49.0 =$	51.0	51
2.36 (No. 8)	3411.3	$\frac{3411.3}{5168.7} \times 100 =$	66.0	$100.0 - 66.0 =$	34.0	34
1.18 (No. 16)	3986.1	$\frac{3986.1}{5168.7} \times 100 =$	77.1	$100.0 - 77.1 =$	22.9	23
0.600 (No. 30)	4315.9	$\frac{4315.9}{5168.7} \times 100 =$	83.5	$100.0 - 83.5 =$	16.5	17
0.300 (No. 50)	4544.4	$\frac{4544.4}{5168.7} \times 100 =$	87.9	$100.0 - 87.9 =$	12.1	12
0.150 (No. 100)	4750.1	$\frac{4750.1}{5168.7} \times 100 =$	91.9	$100.0 - 91.9 =$	8.1	8
0.075 (No. 200)	4885.5	$\frac{4885.5}{5168.7} \times 100 =$	94.5	$100.0 - 94.5 =$	5.5	5.5
FCMR	4905.9					
Total mass after sieving: 4905.9 g						
Original dry mass of the sample (M): 5168.7 g						

\* Report total percent passing to 1 percent except report the 75 µm (No. 200) sieve to 0.1 percent.

**Procedure Method B**

1. Dry the sample to constant mass at according to the FOP for AASHTO T 255. Cool to room temperature.
2. Determine and record the original dry mass of the sample to the nearest 0.1 g. Designate this mass as *M*.

When the specification does not require the amount of material finer than 75  $\mu\text{m}$  (No. 200) be determined by washing, skip to Step 11.

3. Nest a protective sieve, such as a 2.0 mm (No. 10), above the 75  $\mu\text{m}$  (No. 200) sieve.
4. Place the sample in a container and cover with water.

**Note 2:** If required by the agency, add a detergent, dispersing solution, or other wetting agent to the water to assure a thorough separation of the material finer than the 75  $\mu\text{m}$  (No. 200) sieve from the coarser particles. There should be enough wetting agent to produce a small amount of suds when the sample is agitated. Excessive suds may overflow the sieves and carry material away with them.

5. Agitate vigorously to ensure complete separation of the material finer than 75  $\mu\text{m}$  (No. 200) from coarser particles and bring the fine material into suspension above the coarser material. To aid in the agitation process, a utensil may be used. To avoid degradation of the sample when using a mechanical washing device do not exceed 10 minutes.
6. Immediately pour the wash water containing the suspended material over the nested sieves; be careful not to pour out the coarser particles or over fill the 75  $\mu\text{m}$  (No. 200) sieve.
7. Add water to cover material remaining in the container and repeat Step 5. Continue until the wash water is reasonably clear. Rinse utensil, if used, into the washed sample.
8. Remove the upper sieve and return material retained to the washed sample.
9. Rinse the material retained on the 75  $\mu\text{m}$  (No. 200) sieve until water passing through the sieve is reasonably clear and detergent or dispersing agent is removed, if used.
10. Return all material retained on the 75  $\mu\text{m}$  (No. 200) sieve to the container by rinsing into the washed sample.

**Note 3:** Excess water may be carefully removed with a bulb syringe; the removed water must be discharged back over the 75  $\mu\text{m}$  (No. 200) sieve to prevent loss of fines.

11. Dry the washed sample to constant mass according to the FOP for AASHTO T 255. Cool to room temperature.
12. Determine and record the dry mass after wash.
13. Select sieves required by the specification and those necessary to avoid overloading as described in Annex B. With a pan on bottom, nest the sieves increasing in size starting with the 4.75 mm (No. 4).
14. Place the sample, or a portion of the sample, on the top sieve. Sieves may already be in the mechanical shaker, if not place the sieves in the mechanical shaker and shake for the minimum time determined to provide complete separation for the sieve shaker being used (approximately 10 minutes, the time determined by Annex A).

*Note 4:* Excessive shaking (more than 10 minutes) may result in degradation of the sample.

15. Determine and record the individual or cumulative mass retained for each sieve. Ensure that all particles trapped in full openings of the sieve are removed and included in the mass retained.

*Note 5:* For sieves 4.75 mm (No. 4) and larger, check material trapped in less than a full opening by sieving over a full opening. Use coarse wire brushes to clean the 600  $\mu\text{m}$  (No. 30) and larger sieves, and soft hair bristle for smaller sieves.

16. Determine and record the mass of the minus 4.75 mm (No. 4) material in the pan. Designate this mass as  $M_1$ .

17. Perform the *Coarse Check Sum* calculation – Verify the *total mass after coarse sieving* compared to the *dry mass before sieving* to not more than 0.3 percent. The *dry mass before sieving* is the dry mass after wash or the original dry mass ( $M$ ) if performing the sieve analysis without washing. Do not use test results for acceptance if the *Check Sum* result is more than 0.3 percent.

18. Reduce the minus 4.75 mm (No. 4) according to the FOP for AASHTO R 76 to produce a sample with a minimum mass of 500 g. Determine and record the mass of the minus 4.75 mm (No. 4) split, designate this mass as  $M_2$ .

19. Select sieves required by the specification and those necessary to avoid overloading as described in Annex B. With a pan on bottom, nest the sieves increasing in size starting with the 75  $\mu\text{m}$  (No. 200) up to, but not including the 4.75 mm (No. 4) sieve.

20. Place the sample portion on the top sieve and place the sieves in the mechanical shaker. Shake for the minimum time determined to provide complete separation for the sieve shaker being used (approximately 10 minutes, the time determined by Annex A).

21. Determine and record the individual or cumulative mass retained for each sieve and in the pan. Ensure that all particles trapped in full openings of the sieve are removed and included in the mass retained. (See Note 5.)

22. Perform the *Fine Check Sum* calculation – Verify the *total mass after sieving* compared to the *dry mass before sieving* ( $M_2$ ) is not more than 0.3 percent. Do not use test results for acceptance if the *Check Sum* result is more than 0.3 percent.

23. Calculate to the nearest 0.1 percent, the Individual Mass Retained (IMR) or Cumulative Mass Retained (CMR) of the size increment of the reduced sample and the original sample.

24. Calculate the total percent passing.

25. Report total percent passing to 1 percent except report the 75  $\mu\text{m}$  (No. 200) sieve to 0.1 percent.

**Method B Calculations****Check Sum**

$$\text{Coarse Check Sum} = \frac{\text{dry mass before sieving} - \text{total mass after coarse sieving}}{\text{dry mass before sieving}} \times 100$$

$$\text{Fine Check Sum} = \frac{M_2 - \text{total mass after fine sieving}}{M_2} \times 100$$

**Percent Retained for 4.75 mm (No. 4) and larger**

$$IPR = \frac{IMR}{M} \times 100 \quad \text{or} \quad CPR = \frac{CMR}{M} \times 100$$

Where:

IPR	=	Individual Percent Retained
CPR	=	Cumulative Percent Retained
M	=	Original dry mass of the sample
IMR	=	Individual Mass Retained
CMR	=	Cumulative Mass Retained

**Percent Passing (PP) for 4.75 mm (No. 4) and larger**

$$PP = PPP - IPR \quad \text{or} \quad PP = 100 - CPR$$

Where:

PP	=	Percent Passing
PPP	=	Previous Percent Passing

**Minus 4.75mm (No. 4) adjustment factor (R)**

The mass of material retained for each sieve is multiplied by the adjustment factor, the total mass of the minus 4.75 mm (No. 4) from the pan,  $M_1$ , divided by the mass of the reduced split of minus 4.75 mm (No. 4),  $M_2$ . For consistency, this adjustment factor is carried to three decimal places.

$$R = \frac{M_1}{M_2}$$

where:

- R = minus 4.75 mm (No. 4) adjustment factor
- $M_1$  = total mass of minus 4.75 mm (No. 4) before reducing
- $M_2$  = mass of the reduced split of minus 4.75 mm (No. 4)

**Total Individual Mass Retained (TIMR):**

$$TIMR = R \times B$$

where:

- TIMR = Total Individual Mass Retained
- R = minus 4.75 mm (No. 4) adjustment factor
- B = individual mass of the size increment in the reduced portion sieved

**Total Cumulative Mass Retained (TCMR)**

$$TCMR = (R \times B) + D$$

where:

- TCMR = Total Cumulative Mass Retained
- R = minus 4.75 mm (No. 4) adjustment factor
- B = cumulative mass of the size increment in the reduced portion sieved
- D = cumulative mass of plus 4.75mm (No. 4) portion of sample

AGGREGATE

WAQTC

FOP AASHTO T 27 / T 11 (24)

**Method B Example Individual Mass Retained**

Dry mass of total sample, before washing:	3214.0 g
Dry mass of sample after washing:	3085.1 g
Total mass after sieving	
Sum of Individual Masses Retained (IMR) plus the minus 4.75 mm (No. 4) from the pan:	3085.0 g
Amount of 75 µm (No. 200) minus washed out (3214.0 g – 3085.1 g):	128.9 g

**Coarse Check Sum**

$$\text{Coarse Check Sum} = \frac{3085.1 \text{ g} - 3085.0 \text{ g}}{3085.1 \text{ g}} \times 100 = 0.0\%$$

The result is not more than 0.3 percent therefore the results can be used for acceptance purposes.

**Individual Percent Retained (IPR) for 9.5 mm (3/8 in.) sieve**

$$\text{IPR} = \frac{481.4 \text{ g}}{3214.0 \text{ g}} \times 100 = 15.0\%$$

**Percent Passing (PP) for 9.5 mm (3/8 in.) sieve:**

$$\text{PP} = 95.0\% - 15.0\% = 80.0\%$$

**Reported Percent Passing = 80%**

**Method B Individual  
Gradation on Coarse Sieves**

Sieve Size mm (in.)	Individual Mass Retained g (IMR)	Determine IPR by dividing IMR by M and multiplying by 100	Individual Percent Retained (IPR)	Determine PP by subtracting IPR from previous PP	Percent Passing (PP)
16.0 (5/8)	0		0		100
12.5 (1/2)	161.1	$\frac{161.1}{3214.0} \times 100 =$	5.0	$100.0 - 5.0 =$	95.0
9.5 (3/8)	481.4	$\frac{481.4}{3214.0} \times 100 =$	15.0	$95.0 - 15.0 =$	80.0
4.75 (No. 4)	475.8	$\frac{475.8}{3214.0} \times 100 =$	14.8	$80.0 - 14.8 =$	65.2
Minus 4.75 (No. 4) in the pan	1966.7 ( $M_1$ )				
Total mass after sieving: sum of sieves + mass in the pan = 3085.0 g					
Original dry mass of the sample ( $M$ ): 3214.0 g					

### Fine Sample

The minus 4.75 mm (No. 4) from the pan,  $M_1$  (1966.7 g), was reduced according to the FOP for AASHTO R 76, to at least 500 g. In this case, the reduced mass was determined to be **512.8 g**. This is  $M_2$ .

The reduced mass was sieved.

Total mass after sieving equals

Sum of Individual Masses Retained (IMR) including  
minus 75  $\mu\text{m}$  (No. 200) in the pan 511.8 g



AGGREGATE

WAQTC

FOP AASHTO T 27 / T 11 (24)

**Fine Check Sum**

$$\text{Fine Check Sum} = \frac{512.8 \text{ g} - 511.8 \text{ g}}{512.8 \text{ g}} \times 100 = 0.2\%$$

The result is not more than an 0.3 percent therefore the results can be used for acceptance purposes.

**Adjustment Factor (R) for Total Individual Mass Retained (TIMR) on minus 4.75 (No. 4) sieves**

The mass of material retained for each sieve is multiplied by the adjustment factor (R) carried to three decimal places.

$$R = \frac{M_1}{M_2} = \frac{1,966.7 \text{ g}}{512.8 \text{ g}} = 3.835$$

where:

- R = minus 4.75 mm (No. 4) adjustment factor
- M<sub>1</sub> = total mass of minus 4.75 mm (No. 4) from the pan
- M<sub>2</sub> = mass of the reduced split of minus 4.75 mm (No. 4)

Each “individual mass retained” on the fine sieves must be multiplied by R to obtain the *Total Individual Mass Retained (TIMR)*.

**Total Individual Mass Retained (TIMR) for 2.00 mm (No. 10) sieve**

$$TIMR = 3.835 \times 207.1 \text{ g} = 794.2 \text{ g}$$

**Individual Percent Retained (IPR) for 2.00 mm (No. 10) sieve:**

$$IPR = \frac{794.2 \text{ g}}{3214.0 \text{ g}} \times 100 = 24.7\%$$

Percent Passing (PP) 2 mm (No. 10) sieve:

$$PP = 65.2\% - 24.7\% = 40.5\%$$

Reported Percent Passing = 41%

**Method B Individual  
Gradation on Fine Sieves**

Sieve Size mm (in.)	Individual Mass Retained g (IMR)	Determine TIMR by multiplying IMR by $R \left( \frac{M_1}{M_2} \right)$	Total Individual Mass Retained (TIMR)
2.00 (No. 10)	207.1	$207.1 \times 3.835 =$	794.2
0.425 (No. 40)	187.9	$187.9 \times 3.835 =$	720.6
0.210 (No. 80)	59.9	$59.9 \times 3.835 =$	229.7
0.075 (No. 200)	49.1	$49.1 \times 3.835 =$	188.3
minus 0.075 (No. 200) in the pan	7.8		
Total mass after sieving: sum of fine sieves + the mass in the pan = 511.8 g			

AGGREGATE

WAQTC

FOP AASHTO T 27 / T 11 (24)

**Method B Individual  
Final Gradation on All Sieves**

Sieve Size mm (in.)	Total Individual Mass Retained g (TIMR)	Determine IPR by dividing TIMR by M and multiplying by 100	Individual Percent Retained (IPR)	Determine PP by subtracting IPR from previous PP	Percent Passing (PP)	Reported Percent Passing*
16.0 (5/8)	0		0		100	100
12.5 (1/2)	161.1	$\frac{161.1}{3214.0} \times 100 =$	5.0	$100.0 - 5.0 =$	95.0	95
9.5 (3/8)	481.4	$\frac{481.4}{3214.0} \times 100 =$	15.0	$95.0 - 15.0 =$	80.0	80
4.75 (No. 4)	475.8	$\frac{475.8}{3214.0} \times 100 =$	14.8	$80.0 - 14.8 =$	65.2	65
2.00 (No. 10)	794.2	$\frac{794.2}{3214.0} \times 100 =$	24.7	$65.2 - 24.7 =$	40.5	41
0.425 (No. 40)	720.6	$\frac{720.6}{3214.0} \times 100 =$	22.4	$40.5 - 22.4 =$	18.1	18
0.210 (No. 80)	229.7	$\frac{229.7}{3214.0} \times 100 =$	7.1	$18.1 - 7.1 =$	11.0	11
0.075 (No. 200)	188.3	$\frac{188.3}{3214.0} \times 100 =$	5.9	$11.0 - 5.9 =$	5.1	5.1
minus 0.075 (No. 200) in the pan	29.9					
Original dry mass of the sample (M): 3214.0 g						

\* Report total percent passing to 1 percent except report the 75  $\mu$ m (No. 200) sieve to 0.1 percent.

AGGREGATE

WAQTC

FOP AASHTO T 27 / T 11 (24)

**Method B Example Cumulative Mass Retained**

Original dry mass of the sample ( $M$ ):	3214.0 g
Dry mass of sample after washing:	3085.1 g
Total mass after sieving equals	
Cumulative Mass Retained (CMR) on the 4.75 (No. 4) plus the minus 4.75 mm (No. 4) in the pan:	3085.0 g
Amount of 75 $\mu\text{m}$ (No. 200) minus washed out (3214.0 g – 3085.1 g):	128.9 g

**Coarse Check Sum**

$$\text{Coarse Check Sum} = \frac{3085.1 \text{ g} - 3085.0 \text{ g}}{3085.1 \text{ g}} \times 100 = 0.0\%$$

The result is not more than 0.3 percent therefore the results can be used for acceptance purposes.

**Cumulative Percent Retained (CPR) for 9.5 mm (3/8 in.) sieve**

$$\text{CPR} = \frac{642.5 \text{ g}}{3214.0 \text{ g}} \times 100 = 20.0\%$$

**Percent Passing (PP) for 9.5 mm (3/8 in.) sieve**

$$\text{PP} = 100.0\% - 20.0\% = 80.0\%$$

**Reported Percent Passing = 80%**

**Method B Cumulative  
Gradation on Coarse Sieves**

Sieve Size mm (in.)	Cumulative Mass Retained g (CMR)	Determine CPR by dividing CMR by M and multiplying by 100	Cumulative Percent Retained (CPR)	Determine PP by subtracting CPR from 100.0	Percent Passing (PP)
16.0 (5/8)	0		0		100
12.5 (1/2)	161.1	$\frac{161.1}{3214.0} \times 100 =$	5.0	$100.0 - 5.0 =$	95.0
9.5 (3/8)	642.5	$\frac{642.5}{3214.0} \times 100 =$	20.0	$100.0 - 20.0 =$	80.0
4.75 (No. 4)	1118.3 (D)	$\frac{1118.3}{3214.0} \times 100 =$	34.8	$100.0 - 34.8 =$	65.2
Minus 4.75 (No. 4) in the pan	1966.7 (M <sub>1</sub> )				
CMR: $1118.3 + 1966.7 = 3085.0$					
Original dry mass of the sample (M): 3214.0 g					

### Fine Sample

The mass of minus 4.75 mm (No. 4) material in the pan,  $M_1$  (1966.7 g), was reduced according to the FOP for AASHTO R 76, to at least 500 g. In this case, the reduced mass was determined to be **512.8 g**. This is  $M_2$ .

The reduced mass was sieved.

Total mass after fine sieving equals

Final Cumulative Mass Retained (FCMR) (includes minus  
75  $\mu$ m (No. 200) from the pan): 511.8 g

### Fine Check Sum

$$\text{Fine Check Sum} = \frac{512.8 \text{ g} - 511.8 \text{ g}}{512.8 \text{ g}} \times 100 = 0.2\%$$

The result is not more than 0.3 percent therefore the results can be used for acceptance purposes.

The cumulative mass of material retained for each sieve is multiplied by the adjustment factor ( $R$ ) carried to three decimal places to obtain the *Adjusted Cumulative Mass Retained (ACMR)* and added to the cumulative mass retained on the 4.75 mm (No. 4) sieve,  $D$ , to obtain the *Total Cumulative Mass Retained (TCMR)*.

**Adjustment factor ( $R$ ) for Adjusted Cumulative Mass Retained (ACMR) in minus 4.75 (No. 4) sieves.**

$$R = \frac{M_1}{M_2} = \frac{1,966.7 \text{ g}}{512.8 \text{ g}} = 3.835$$

where:

- $R$  = minus 4.75 mm (No. 4) adjustment factor
- $M_1$  = total mass of minus 4.75 mm (No. 4) from the pan
- $M_2$  = mass of the reduced split of minus 4.75 mm (No. 4)

**Adjusted Cumulative Mass Retained (ACMR) for the 2.00 mm (No. 10) sieve**

$$ACMR = 3.835 \times 207.1 \text{ g} = 794.2 \text{ g}$$

**Total Cumulative Mass Retained (TCMR) for the 2.00 mm (No. 10) sieve**

$$TCMR = 794.2 \text{ g} + 1118.3 \text{ g} = 1912.5 \text{ g}$$

**Cumulative Percent Retained (CPR) for 2.00 mm (No. 10) sieve:**

$$CPR = \frac{1912.5 \text{ g}}{3214.0 \text{ g}} \times 100 = 59.5\%$$

**Percent Passing (PP) 2.00 mm (No. 10) sieve:**

$$PP = 100.0\% - 59.5\% = 40.5\%$$

**Reported Percent Passing = 41%**

AGGREGATE

WAQTC

FOP AASHTO T 27 / T 11 (24)

**Method B Cumulative  
Gradation on Fine Sieves**

Sieve Size mm (in.)	Cumulative Mass Retained, g (CMR)	Determine TCMR by multiplying CMR by $R \left( \frac{M_1}{M_2} \right)$ and adding D	Total Cumulative Mass Retained (TCMR)
2.00 (No. 10)	207.1	$207.1 \times 3.835 + 1118.3 =$	1912.5
0.425 (No. 40)	395.0	$395.0 \times 3.835 + 1118.3 =$	2633.1
0.210 (No. 80)	454.9	$454.9 \times 3.835 + 1118.3 =$	2862.8
0.075 (No. 200)	504.0	$504.0 \times 3.835 + 1118.3 =$	3051.1
FCMR	511.8		
Total: sum of masses on fine sieves + minus 75 $\mu\text{m}$ (No. 200) in the pan = 511.8			

**Method B Cumulative  
Final Gradation on All Sieves**

Sieve Size mm (in.)	Total Cumulative Mass Retained g (TCMR)	Determine CPR by dividing CMR by M and multiplying by 100	Cumulative Percent Retained (CPR)	Determine PP by subtracting CPR from 100.0	Percent Passing (PP)	Reported Percent Passing*
16.0 (5/8)	0		0		100.0	100
12.5 (1/2)	161.1	$\frac{161.1}{3214.0} \times 100 =$	5.0	$100.0 - 5.0 =$	95.0	95
9.5 (3/8)	642.5	$\frac{642.5}{3214.0} \times 100 =$	20.0	$100.0 - 20.0 =$	80.0	80
4.75 (No. 4)	1118.3 (D)	$\frac{1118.3}{3214.0} \times 100 =$	34.8	$100.0 - 34.8 =$	65.2	65
2.00 (No. 10)	1912.5	$\frac{1912.5}{3214.0} \times 100 =$	59.5	$100.0 - 59.5 =$	40.5	41
0.425 (No. 40)	2633.1	$\frac{2633.1}{3214.0} \times 100 =$	81.9	$100.0 - 81.9 =$	18.1	18
0.210 (No. 80)	2862.8	$\frac{2862.8}{3214.0} \times 100 =$	89.1	$100.0 - 89.1 =$	10.9	11
0.075 (No. 200)	3051.1	$\frac{3051.1}{3214.0} \times 100 =$	94.9	$100.0 - 94.9 =$	5.1	5.1
FCMR	3081.1					
Original dry mass of the sample (M): 3214.0 g						

\* Report total percent passing to 1 percent except report the 75 µm (No. 200) sieve to 0.1 percent.



**Procedure Method C**

1. Dry the sample to constant mass at according to the FOP for AASHTO T 255. Cool to room temperature.
2. Determine and record the original dry mass of the sample to the nearest 0.1 g. Designate this mass as  $M$ .
3. Break up any aggregations or lumps of clay, silt, or adhering fines to pass the 4.75 mm (No. 4) sieve.
4. Select sieves required by the specification and those necessary to avoid overloading as described in Annex B. With a pan on bottom, nest the sieves increasing in size starting with the 4.75 mm (No. 4) sieve.
5. Place the sample, or a portion of the sample, on the top sieve. Sieves may already be in the mechanical shaker, if not place the sieves in the mechanical shaker and shake for the minimum time determined to provide complete separation for the sieve shaker being used (approximately 10 minutes, the time determined by Annex A).

**Note 2:** Excessive shaking (more than 10 minutes) may result in degradation of the sample.

6. Determine and record the cumulative mass retained for each sieve. Ensure that all material trapped in full openings of the sieve are removed and included in the mass retained.

**Note 3:** For sieves 4.75 mm (No. 4) and larger, check material trapped in less than a full opening sieving over a full opening. Use coarse wire brushes to clean the 600  $\mu\text{m}$  (No. 30) and larger sieves, and soft bristle brush for smaller sieves.

7. Determine and record the mass of the minus 4.75 mm (No. 4) material in the pan. Designate this mass as  $M_1$ .
8. Perform the *Coarse Check Sum* calculation –Verify the *total mass after coarse sieving* compared to the *original dry mass (M)* is not more than 0.3 percent.
9. Reduce the minus 4.75 mm (No. 4) according to the FOP for AASHTO R 76, to produce a sample with a minimum mass of 500 g.
10. Determine and record the mass of the minus 4.75 mm (No. 4) split, designate this mass as  $M_3$ .
11. Nest a protective sieve, such as a 2.0 mm (No. 10), above the 75  $\mu\text{m}$  (No. 200) sieve.
12. Place the sample in a container and cover with water.

**Note 4:** If required by the agency, add a detergent, dispersing solution, or other wetting agent to the water to assure a thorough separation of the material finer than the 75  $\mu\text{m}$  (No. 200) sieve from the coarser particles. There should be enough wetting agent to produce a small amount of suds when the sample is agitated. Excessive suds may overflow the sieves and carry material away with them.

13. Agitate vigorously to ensure complete separation of the material finer than 75  $\mu\text{m}$  (No. 200) from coarser particles and bring the fine material into suspension above the coarser material. To aid in the agitation process, a utensil may be used. To avoid degradation of the sample when using a mechanical washing device do not exceed 10 minutes.

14. Immediately pour the wash water containing the suspended material over the nested sieves; be careful not to pour out the coarser particles or over fill the 75  $\mu\text{m}$  (No. 200) sieve.
  15. Add water to cover material remaining in the container and repeat Step 12. Repeat until the wash water is reasonably clear. Rinse utensil, if used, into the washed sample.
  16. Remove the upper sieve and return material retained to the washed sample.
  17. Rinse the material retained on the 75  $\mu\text{m}$  (No. 200) sieve until water passing through the sieve is reasonably clear and detergent or dispersing agent is removed, if used.
  18. Return all material retained on the 75  $\mu\text{m}$  (No. 200) sieve to the container by flushing into the washed sample.
- Note 5:* Excess water may be carefully removed with a bulb syringe; the removed water must be discharged back over the 75  $\mu\text{m}$  (No. 200) sieve to prevent loss of fines.
19. Dry the washed sample portion to constant mass according to the FOP for AASHTO T 255. Cool to room temperature.
  20. Determine and record the dry mass, designate this mass as *dry mass before sieving*.
  21. Select sieves required by the specification and those necessary to avoid overloading as described in Annex B. With a pan on bottom, nest the sieves increasing in size starting with the 75  $\mu\text{m}$  (No. 200) sieve up to, but not including the 4.75 mm (No. 4) sieve.
  22. Place the sample portion on the top sieve. Place the sieves in the mechanical shaker and shake for the minimum time determined to provide complete separation for the sieve shaker being used (approximately 10 minutes, the time determined by Annex A).
- Note 6:* Excessive shaking (more than 10 minutes) may result in degradation of the sample.
23. Determine and record the cumulative mass retained for each sieve. Ensure that all material trapped in full openings of the sieve are removed and included in the mass retained. See Note 3.
  24. Perform the *Fine Check Sum* calculation – Verify the *total mass after fine sieving* compared to the *dry mass before sieving* is not more than 0.3 percent. Do not use test results for acceptance if the *Check Sum* is more than 0.3 percent.
  25. Calculate the Cumulative Percent Retained (CPR) and Percent Passing (PP) for the 4.75 mm (No. 4) and larger.
  26. Calculate the Cumulative Percent Retained (CPR<sub>#4</sub>) and the Percent Passing (PP<sub>#4</sub>) for minus 4.75 mm (No. 4) split and Percent Passing (PP) for the minus 4.75 mm (No. 4).
  27. Report total percent passing to 1 percent except report the 75  $\mu\text{m}$  (No. 200) sieve to 0.1 percent.

**Method C Calculations****Check Sum**

$$\text{Coarse check sum} = \frac{M - \text{total mass after coarse sieving}}{M} \times 100$$

$$\text{Fine check sum} = \frac{\text{dry mass before sieving} - \text{total mass after fine sieving}}{\text{dry mass before sieving}} \times 100$$

where:

M = Original dry mass of the sample

**Cumulative Percent Retained (CPR) for 4.75 mm (No. 4) sieve and larger**

$$CPR = \frac{CMR}{M} \times 100$$

where:

CPR = Cumulative Percent Retained of the size increment for the total sample

CMR = Cumulative Mass Retained of the size increment for the total sample

M = Total dry sample mass before washing

**Percent Passing (PP) 4.75 mm (No. 4) sieve and larger**

$$PP = 100 - CPR$$

where:

PP = Percent Passing of the size increment for the total sample

CPR = Cumulative Percent Retained of the size increment for the total sample

**Or calculate PP for sieves larger than 4.75 mm (No. 4) sieve without calculating CPR**

$$\frac{M - CMR}{M} \times 100$$

**Cumulative Percent Retained (CPR<sub>#4</sub>) for minus 4.75 mm (No. 4) split**

$$CPR_{\#4} = \frac{CMR_{\#4}}{M_3} \times 100$$

where:

- CPR<sub>#4</sub> = Cumulative Percent Retained for the sieve sizes of M<sub>3</sub>
- CMR<sub>#4</sub> = Cumulative Mass Retained for the sieve sizes of M<sub>3</sub>
- M<sub>3</sub> = Total mass of the minus 4.75 mm (No. 4) split before washing

**Percent Passing (PP<sub>#4</sub>) for minus 4.75 mm (No. 4) split**

$$PP_{\#4} = 100 - CPR_{\#4}$$

where:

- PP<sub>#4</sub> = Percent Passing for the sieve sizes of M<sub>3</sub>
- CPR<sub>#4</sub> = Cumulative Percent Retained for the sieve sizes of M<sub>3</sub>

**Percent Passing (PP) for sieves smaller than 4.75 mm (No. 4) sieve**

$$PP = \frac{(PP_{\#4} \times \#4 PP)}{100}$$

where:

- PP = Total Percent Passing
- PP<sub>#4</sub> = Percent Passing for the sieve sizes of M<sub>3</sub>
- #4 PP = Total Percent Passing the 4.75 mm (No. 4) sieve

AGGREGATE

WAQTC

FOP AASHTO T 27 / T 11 (24)

Or calculate PP for sieves smaller than 4.75 mm (No. 4) sieve without calculating CPR<sub>#4</sub> and PP<sub>#4</sub>

$$PP = \frac{\#4 PP}{M_3} \times (M_3 - CMR_{\#4})$$

where:

- PP = Total Percent Passing  
 #4 PP = Total Percent Passing the 4.75 mm (No. 4) sieve  
 M<sub>3</sub> = Total mass of the minus 4.75 mm (No. 4) split before washing  
 CMR<sub>#4</sub> = Cumulative Mass Retained for the sieve sizes of M<sub>3</sub>

### Method C Example

Original dry mass of the sample (M):	3304.5 g
Total mass after sieving equals	
Cumulative Mass Retained (CMR) on the 4.75 (No. 4) plus the minus 4.75 mm (No. 4) from the pan:	3085.0 g

### Coarse Check Sum

$$Coarse\ Check\ Sum = \frac{3304.5\ g - 3304.5\ g}{3304.5\ g} \times 100 = 0.0\%$$

The result is not more than 0.3 percent therefore the results can be used for acceptance purposes.

### Cumulative Percent Retained (CPR) for the 9.5 mm (3/8 in.) sieve:

$$CPR = \frac{604.1\ g}{3304.5\ g} \times 100 = 18.3\%$$

**Percent Passing (PP) for the 9.5 mm (3/8 in.) sieve:**

$$PP = 100.0\% - 18.3\% = 81.7\%$$

**Reported Percent Passing = 82%**

**Example for Alternate Percent Passing (PP) formula for the 9.5 mm (3/8 in.) sieve:**

$$PP = \frac{3304.5 - 604.1}{3304.5} \times 100 = 81.7\%$$

**Reported Percent Passing = 82%**

**Method C Cumulative  
Gradation on Coarse Sieves**

Sieve Size mm (in.)	Cumulative Mass Retained, g (CMR)	Determine CPR by dividing CMR by M and multiplying by 100	Cumulative Percent Retained (CPR)	Determine PP by subtracting CPR from 100.0	Percent Passing (PP)	Reported Percent Passing*
16.0 (5/8)	0		0.0		100.0	100
12.5 (1/2)	125.9	$\frac{125.9}{3304.5} \times 100 =$	3.8	$100.0 - 3.8 =$	96.2	96
9.5 (3/8)	604.1	$\frac{604.1}{3304.5} \times 100 =$	18.3	$100.0 - 18.3 =$	81.7	82
4.75 (No. 4)	1295.6	$\frac{1295.6}{3304.5} \times 100 =$	39.2	$100.0 - 39.2 =$	<b>60.8</b> <b>(#4 PP)</b>	61
Mass in pan	2008.9					
CMR: 1295.6 + 2008.9 = 3304.5						
Original dry mass of the sample (M): 3304.5						

AGGREGATE

WAQTC

FOP AASHTO T 27 / T 11 (24)

**Fine Sample**

The pan (2008.9 g) was reduced according to the FOP for AASHTO R 76, to at least 500 g. In this case, the reduced mass was determined to be **527.6 g**. This is  $M_3$ .

Dry mass of minus 4.75mm (No. 4) reduced portion before wash ( $M_3$ ): 527.6 g

Dry mass of minus 4.75mm (No. 4) reduced portion after wash: 495.3 g

Total mass after fine sieving equals

Final Cumulative Mass Retained (FCMR)  
(includes minus 75  $\mu\text{m}$  (No. 200) from the pan): 495.1 g

**Fine Check Sum**

$$\text{Fine Check Sum} = \frac{495.3 \text{ g} - 495.1 \text{ g}}{495.3 \text{ g}} \times 100 = 0.0\%$$

The result is not more than 0.3 percent therefore the results can be used for acceptance purposes.

**Cumulative Percent Retained ( $CPR_{\#4}$ ) for minus 4.75 mm (No. 4) for the 2.0 mm (No. 10) sieve:**

$$CPR_{\#4} = \frac{194.3 \text{ g}}{527.6 \text{ g}} \times 100 = 36.8\%$$

**Percent Passing ( $PP_{\#4}$ ) for minus 4.75 mm (No. 4) for the 2.0 mm (No. 10) sieve:**

$$PP_{\#4} = 100.0\% - 36.8\% = 63.2\%$$

**Method C Cumulative  
Gradation on Fine Sieves**

77

Sieve Size mm (in.)	Cumulative Mass Retained g (CMR <sub>#4</sub> )	Determine CPR <sub>#4</sub> by dividing CMR by M <sub>3</sub> and multiplying by 100	Cumulative Percent Retained <sub>#4</sub> (CPR <sub>#4</sub> )	Determine PP <sub>#4</sub> by subtracting CPR <sub>#4</sub> from 100.0	Percent Passing <sub>#4</sub> (PP <sub>#4</sub> )
2.0 (No. 10)	194.3	$\frac{194.3}{527.6} \times 100 =$	36.8	$100.0 - 36.8 =$	63.2
0.425 (No. 40)	365.6	$\frac{365.6}{527.6} \times 100 =$	69.3	$100.0 - 69.3 =$	30.7
0.210 (No. 80)	430.8	$\frac{430.8}{527.6} \times 100 =$	81.7	$100.0 - 81.7 =$	18.3
0.075 (No. 200)	484.4	$\frac{484.4}{527.6} \times 100 =$	91.8	$100.0 - 91.8 =$	8.2
FCMR	495.1				
Dry mass of minus 4.75mm (No. 4) reduced portion before wash (M <sub>3</sub> ): 527.6 g					
Dry mass after washing: 495.3 g					

**Percent Passing (PP) for the 2.0 mm (No. 10) sieve for the entire sample:**

78

#4 PP (Total Percent Passing the 4.75 mm (No. 4) sieve) = 60.8%

$$PP = \frac{63.2\% \times 60.8\%}{100} = 38.4\%$$

**Reported Percent Passing = 38%**



AGGREGATE

WAQTC

FOP AASHTO T 27 / T 11 (24)

**Method C Cumulative  
Final Gradation on All Sieves**

Sieve Size mm (in.)	Cumulative Mass Retained g (CMR)	Cumulative Percent Retained (CPR)	Percent Passing (PP -#4)	Determine PP by multiplying PP-#4 by #4 PP and dividing by 100	Percent Passing (PP)	Reported Percent Passing*
16.0 (5/8)	0	0.0			100.0	100
12.5 (1/2)	125.9	3.8			96.2	96
9.5 (3/8)	604.1	18.3			81.7	82
4.75 (No. 4)	1295.6	39.2			<b>60.8</b> <b>(#4 PP)</b>	61
2.0 (No. 10)	194.3	36.8	63.2	$\frac{63.2 \times 60.8}{100} =$	38.4	38
0.425 (No. 40)	365.6	69.3	30.7	$\frac{30.7 \times 60.8}{100} =$	18.7	19
0.210 (No. 80)	430.8	81.7	18.3	$\frac{18.3 \times 60.8}{100} =$	11.1	11
0.075 (No. 200)	484.4	91.8	8.2	$\frac{8.2 \times 60.8}{100} =$	5.0	5.0
FCMR	495.1					

\* Report total percent passing to 1 percent except report the 75 µm (No. 200) sieve to 0.1 percent.

**Example for Alternate Percent Passing (PP) for the 4.75 mm (No. 4) sieve for the entire sample:**

#4 PP (Total Percent Passing the 4.75 mm (No. 4) sieve) = 60.8%

$$PP = \frac{60.8\%}{527.6} \times (527.6 - 194.3) = 38.4\%$$

**Reported Percent Passing = 38%**

**Alternate Method C Cumulative  
Gradation on Coarse Sieves**

Sieve Size mm (in.)	Cumulative Mass Retained, g (CMR)	Determine PP by subtracting CMR from M, and dividing the result by M then multiplying by 100	Percent Passing (PP)	Reported Percent Passing*
16.0 (5/8)	0.0		100.0	100
12.5 (1/2)	125.9	$\frac{3304.5 - 125.9}{3304.5} \times 100 =$	96.2	96
9.5 (3/8)	604.1	$\frac{3304.5 - 604.1}{3304.5} \times 100 =$	81.7	82
4.75 (No. 4)	1295.6	$\frac{3304.5 - 1295.6}{3304.5} \times 100 =$	<b>60.8</b> <b>(#4 PP)</b>	61
Mass in Pan	2008.9			
Cumulative sieved mass: 1295.6 + 2008.9 = 3304.5				
Original dry mass of the sample (M): 3304.5				

AGGREGATE

WAQTC

FOP AASHTO T 27 / T 11 (24)

**Alternate Method C Cumulative  
Gradation on Fine Sieves**

Sieve Size mm (in.)	Cumulative Mass Retained g (CMR <sub>#4</sub> )	Determine PP <sub>#4</sub> by subtracting CMR <sub>#4</sub> from M <sub>3</sub> , dividing result by M <sub>3</sub> and multiplying by 100	Percent Passing <sub>#4</sub> (PP <sub>#4</sub> )
2.0 (No. 10)	194.3	$\frac{527.6 - 194.3}{527.6} \times 100 =$	63.2
0.425 (No. 40)	365.6	$\frac{527.6 - 365.6}{527.6} \times 100 =$	30.7
0.210 (No. 80)	430.8	$\frac{527.6 - 430.8}{527.6} \times 100 =$	18.3
0.075 (No. 200)	484.4	$\frac{527.6 - 484.4}{527.6} \times 100 =$	8.2
FCMR	495.1		
Dry mass of minus 4.75mm (No. 4) reduced portion before wash (M <sub>3</sub> ): 527.6 g			
Dry mass after washing: 495.3 g			

**Alternate Method C Cumulative  
Final Gradation on All Sieves**

Sieve Size mm (in.)	Percent Passing <sub>#4</sub> (PP <sub>#4</sub> )	Determine PP by multiplying PP <sub>#4</sub> by #4 PP and dividing by 100	Determined Percent Passing (PP)	Reported Percent Passing*
16.0 (5/8)			100.0	100
12.5 (1/2)			96.2	96
9.5 (3/8)			81.7	82
4.75 (No. 4)			<b>60.8</b> <b>(#4 PP)</b>	61
2.0 (No. 10)	63.2	$\frac{63.2 \times 60.8}{100} =$	38.4	38
0.425 (No. 40)	30.7	$\frac{30.7 \times 60.8}{100} =$	18.7	19
0.210 (No. 80)	18.3	$\frac{18.3 \times 60.8}{100} =$	11.1	11
0.075 (No. 200)	8.2	$\frac{8.2 \times 60.8}{100} =$	5.0	5.0

\* Report total percent passing to 1 percent except report the 75 μm (No. 200) sieve to 0.1 percent.

## FINENESS MODULUS

Fineness Modulus (FM) is used in determining the degree of uniformity of the aggregate gradation in PCC mix designs. It is an empirical number relating to the fineness of the aggregate. The higher the FM the coarser the aggregate. Values of 2.40 to 3.00 are common for fine aggregate in PCC.

The sum of the cumulative percentages retained on specified sieves in the following table divided by 100 gives the FM.

### Sample Calculation

	Example A				Example B		
	Percent				Percent		
		Retained				Retained	
Sieve Size mm (in)	Passing		On Spec'd Sieves*		Passing		On Spec'd Sieves*
75*(3)	100	0	0		100	0	0
37.5*(11/2)	100	0	0		100	0	0
19*(3/4)	15	85	85		100	0	0
9.5*(3/8)	0	100	100		100	0	0
4.75*(No.4)	0	100	100		100	0	0
2.36*(No.8)	0	100	100		87	13	13
1.18*(No.16)	0	100	100		69	31	31
0.60*(No.30)	0	100	100		44	56	56
0.30*(No.50)	0	100	100		18	82	82
0.15*(100)	0	100	100		4	96	96
			$\Sigma = 785$				$\Sigma = 278$
			FM = 7.85				FM = 2.78

In decreasing size order, each \* sieve is one-half the size of the preceding \* sieve.

AGGREGATE

WAQTC

FOP AASHTO T 27 / T 11 (24)

**Report**

- On forms approved by the agency
- Sample ID
- Individual mass retained for each sieve
- Individual percent retained for each sieve
- or
- Cumulative mass retained for each sieve
- Cumulative percent retained for each sieve
- FM to the nearest 0.01
- Report percent passing to the nearest 1 percent except for the 75  $\mu\text{m}$  (No. 200) sieve, report to the nearest 0.1 percent.

---

**ANNEX A****Time Evaluation**

(Mandatory information)

The sieving time for each mechanical sieve shaker shall be checked at least annually to determine the time required for complete separation of the sample by the following method:

1. Shake the sample over nested sieves for approximately 10 minutes.
2. Provide a snug-fitting pan and cover for each sieve and hold in a slightly inclined position in one hand.
3. Hand shake each sieve by striking the side of the sieve sharply and with an upward motion against the heel of the other hand at the rate of about 150 times per minute, turning the sieve about one sixth of a revolution at intervals of about 25 strokes.

*Note A1:* A mallet may be used instead of the heel of the hand if comparable force is used.

If more than 0.5 percent by mass of the total sample before sieving passes any sieve after one minute of continuous hand shaking adjust shaker time and re-check.

In determining sieving time for sieve sizes larger than 4.75 mm (No. 4), limit the material on the sieve to a single layer of particles.

**ANNEX B****Overload Determination**

(Mandatory information)

The amount of material retained on a sieve may be regulated by:

- adding a sieve with larger openings immediately above the given sieve
- sieving the sample in multiple increments
- sieving the sample over a nest of sieves with a larger sieve-frame dimension.

**TABLE B1**

**Maximum Allowable Mass of Material Retained on a Sieve, g**  
**Nominal Sieve Size, mm (in.)**  
**Exact size is smaller (see AASHTO T 27)**

Sieve Size	203 dia	305 dia	305 by 305	350 by 350	372 by 580
mm (in.)	(8)	(12)	(12 × 12)	(14 × 14)	(16 × 24)
Sieving Area m <sup>2</sup>					
	0.0285	0.0670	0.0929	0.1225	0.2158
90 (3 1/2)	*	15,100	20,900	27,600	48,500
75 (3)	*	12,600	17,400	23,000	40,500
63 (2 1/2)	*	10,600	14,600	19,300	34,000
50 (2)	3600	8400	11,600	15,300	27,000
37.5 (1 1/2)	2700	6300	8700	11,500	20,200
25.0 (1)	1800	4200	5800	7700	13,500
19.0 (3/4)	1400	3200	4400	5800	10,200
16.0 (5/8)	1100	2700	3700	4900	8600
12.5 (1/2)	890	2100	2900	3800	6700
9.5 (3/8)	670	1600	2200	2900	5100
6.3 (1/4)	440	1100	1500	1900	3400
4.75 (No. 4)	330	800	1100	1500	2600
-4.75 (-No. 4)	200	470	650	860	1510

For sieves with openings smaller than 4.75 mm (No. 4), the mass retained on any sieve shall not exceed 7 kg/m<sup>2</sup> (4 g/in<sup>2</sup>) of sieving surface.

For sieves with openings 4.75 mm (No. 4) and larger, the mass, in grams shall not exceed the product of 2.5 × (sieve opening in mm) × (effective sieving area). See Table B1.



**PERFORMANCE EXAM CHECKLIST**

**METHOD A  
SIEVE ANALYSIS OF FINE AND COARSE AGGREGATES  
FOP FOR AASHTO T 27  
MATERIALS FINER THAN 75 µm (No. 200) SIEVE IN MINERAL AGGREGATE  
BY WASHING  
FOP FOR AASHTO T 11**

Participant Name \_\_\_\_\_ Exam Date \_\_\_\_\_

Record the symbols “P” for passing or “F” for failing on each step of the checklist.

Procedure Element	Trial 1	Trial 2
1. Minimum sample mass meets requirement of Table 1?	_____	_____
2. Sample dried to a constant mass by FOP for AASHTO T 255?	_____	_____
3. Sample cooled, and original dry mass of the sample recorded to the nearest 0.1 g?	_____	_____
4. Sample placed in container and covered with water?	_____	_____
5. Contents of the container vigorously agitated?	_____	_____
6. Suspension of minus 75 µm (No. 200) achieved?	_____	_____
7. Wash water poured through nested sieves such as 2 mm (No. 10) and 75 µm (No. 200)?	_____	_____
8. Operation continued until wash water is reasonably clear?	_____	_____
9. Material retained on sieves returned to washed sample?	_____	_____
a. Utensil rinsed?	_____	_____
10. Washed sample dried to a constant mass by FOP for AASHTO T 255?	_____	_____
11. Washed sample cooled, and dry mass recorded to the nearest 0.1 g?	_____	_____
12. Sample placed in nest of sieves specified? (Additional sieves may be used to prevent overloading as allowed in FOP.)	_____	_____
13. Material sieved in verified mechanical shaker for proper time?	_____	_____
14. Mass of material on each sieve and pan recorded to 0.1 g?	_____	_____
15. Total mass of material after sieving compared to the mass before sieving is not more than 0.3 percent (check sum)?	_____	_____

**OVER**

AGGREGATE

WAQTC

FOP AASHTO T 27/T 11 (24)

**Procedure Element**

**Trial 1 Trial 2**

16. Percentages calculated to the nearest 0.1 percent and reported to the nearest whole number, except 75 μm (No. 200) which is reported to the nearest 0.1 percent?

\_\_\_\_\_

17. Percentage calculations based on original dry mass of the sample?

\_\_\_\_\_

18. Calculations performed properly?

\_\_\_\_\_

Comments: First attempt: Pass \_\_\_\_\_ Fail \_\_\_\_\_ Second attempt: Pass \_\_\_\_\_ Fail \_\_\_\_\_

\_\_\_\_\_  
\_\_\_\_\_  
\_\_\_\_\_  
\_\_\_\_\_  
\_\_\_\_\_  
\_\_\_\_\_  
\_\_\_\_\_

**Examiner Signature** \_\_\_\_\_ **WAQTC #:** \_\_\_\_\_

**PERFORMANCE EXAM CHECKLIST**

**METHOD B  
SIEVE ANALYSIS OF FINE AND COARSE AGGREGATES  
FOP FOR AASHTO T 27  
MATERIALS FINER THAN 75 µm (No. 200) SIEVE IN MINERAL AGGREGATE  
BY WASHING  
FOP FOR AASHTO T 11**

Participant Name \_\_\_\_\_ Exam Date \_\_\_\_\_

Record the symbols “P” for passing or “F” for failing on each step of the checklist.

Procedure Element	Trial 1	Trial 2
1. Minimum sample mass meets requirement of Table 1?	_____	_____
2. Sample dried to a constant mass by FOP for AASHTO T 255?	_____	_____
3. Sample cooled, and original dry mass of the sample recorded to the nearest 0.1 g?	_____	_____
4. Sample placed in container and covered with water?	_____	_____
5. Contents of the container vigorously agitated?	_____	_____
6. Suspension of minus 75 µm (No. 200) achieved?	_____	_____
7. Wash water poured through nested sieves such as 2 mm (No. 10) and 75 µm (No. 200)?	_____	_____
8. Operation continued until wash water is reasonably clear?	_____	_____
9. Material retained on sieves returned to washed sample? a. Utensil rinsed?	_____	_____
10. Washed sample dried to a constant mass by FOP for AASHTO T 255 ?	_____	_____
11. Washed sample cooled, and dry mass recorded to nearest 0.1 g?	_____	_____
12. Sample placed in nest of sieves specified? (Additional sieves may be used to prevent overloading as allowed in FOP.)	_____	_____
13. Material sieved in verified mechanical shaker for proper time?	_____	_____
14. Mass of material on each sieve and pan determined to the nearest 0.1 g?	_____	_____
15. Total mass of material after sieving compared to the mass before sieving is not more than 0.3 percent (coarse check sum)?	_____	_____

**OVER**

**Procedure Element**

**Trial 1 Trial 2**

16. Material in pan reduced in accordance with FOP for AASHTO R 76 to at least 500 g?

\_\_\_\_\_

17. Mass of minus 4.75 mm (No. 4) split recorded to the nearest 0.1 g?

\_\_\_\_\_

18. Sample placed in nest of sieves specified? (Additional sieves may be used to prevent overloading as allowed in FOP.)

\_\_\_\_\_

19. Material sieved in verified mechanical shaker for proper time?

\_\_\_\_\_

20. Mass of material on each sieve and pan recorded to the nearest 0.1 g?

\_\_\_\_\_

21. Total mass of material after sieving compared to the mass before sieving is not more than 0.3 percent (fine check sum)?

\_\_\_\_\_

22. Percentages calculated to the nearest 0.1 percent and reported to the nearest whole number, except 75 µm (No. 200) which is reported to the nearest 0.1 percent?

\_\_\_\_\_

23. Percentage calculations based on original dry mass of the sample?

\_\_\_\_\_

24. Calculations performed properly?

\_\_\_\_\_

Comments: First attempt: Pass \_\_\_\_\_ Fail \_\_\_\_\_ Second attempt: Pass \_\_\_\_\_ Fail \_\_\_\_\_

\_\_\_\_\_  
\_\_\_\_\_  
\_\_\_\_\_  
\_\_\_\_\_  
\_\_\_\_\_  
\_\_\_\_\_  
\_\_\_\_\_  
\_\_\_\_\_

**Examiner Signature** \_\_\_\_\_ **WAQTC #:** \_\_\_\_\_

## **WSDOT Errata to FOP for AASHTO T 30**

### ***Mechanical Analysis of Extracted Aggregate***

WAQTC FOP for AASHTO T 30 has been adopted by WSDOT with the following changes:

#### **Procedure**

18. *Step not recognized by WSDOT.*



## MECHANICAL ANALYSIS OF EXTRACTED AGGREGATE FOP FOR AASHTO T 30

### Scope

This procedure covers mechanical analysis of aggregate recovered from asphalt mix samples in accordance with AASHTO T 30-24. This FOP uses the aggregate recovered from the ignition furnace used in AASHTO T 308. AASHTO T 30 was developed for analysis of extracted aggregate and thus includes references to extracted bitumen and filter element, which do not apply in this FOP.

Sieve analyses determine the gradation or distribution of aggregate particles within a given sample to determine compliance with design and production standards.

### Apparatus

- Balance or scale: Capacity sufficient for the sample mass, readable to 0.1 g and conforming to AASHTO M 231.
- Sieves, meeting the requirements of FOP for AASHTO T 27/T 11.
- Mechanical sieve shaker, meeting the requirements of FOP for AASHTO T 27/T 11.
- Mechanical Washing Apparatus (optional).
- Suitable drying equipment, meeting the requirements of the FOP for AASHTO T 255.
- Containers: A pan or vessel of a size sufficient to contain the sample covered with water and to permit vigorous agitation without loss of any part of the sample or water.
- Wetting Agent: Any dispersing agent, such as dishwashing detergent, that will promote separation of the fine materials.
- Utensil: device for agitating the sample during the washing procedure.

### Sample Sieving

- In this procedure, it is required to shake the sample over nested sieves. Sieves are selected to furnish information required by specification. Intermediate sieves are added for additional information or to avoid overloading sieves, or both.
- The sieves are nested in order of increasing size from the bottom to the top, and the test sample, or a portion of the test sample, is placed on the top sieve.
- The loaded sieves are shaken in a mechanical shaker for approximately 10 minutes, refer to Annex A; *Time Evaluation*.

### Mass Verification

The aggregate sample mass,  $M_{(T30)}$ , determined in this method, shall agree with the mass of the aggregate remaining after ignition,  $M_f$  from the FOP for AASTHO T 308, within 0.1 percent. If the variation exceeds 0.1 percent, the results cannot be used for acceptance.

**Procedure**

1. Determine and record the mass of the sample that was removed from the basket in the FOP for AASHTO T 308 to 0.1 g. Designate this mass as  $M_{(T30)}$ .
  2. Verify the mass of the sample is within 0.1 percent by subtracting  $M_{(T30)}$  from  $M_{f(T308)}$  dividing by  $M_{f(T308)}$  and multiplying by 100 (see *Mass Verification Calculation* and example).  
If the variation exceeds 0.1 percent, the sieve analysis results cannot be used for acceptance.
  3. Nest a sieve, such as a 2.0 mm (No. 10) or 1.18 mm (No. 16), above the 75 $\mu$ m (No. 200) sieve.
  4. Place the test sample in a container and cover with water. Add a wetting agent to the water to assure a thorough separation of the material finer than the 75 $\mu$ m (No. 200) sieve from the coarser particles. There should be enough wetting agent to produce a small amount of suds when the sample is agitated. Excessive suds may overflow the sieves and carry material away with them.
  5. Agitate vigorously to ensure complete separation of the material finer than 75 $\mu$ m (No. 200) from coarser particles and bring the fine material into suspension above the coarser material. Use a utensil to aid in the agitation process. To avoid degradation of the sample when using a mechanical washing device do not exceed 10 min.
- Note 1:* When mechanical washing equipment is used, the introduction of water, agitating, and decanting may be a continuous operation. Use care not to overflow or overload the 75 $\mu$ m (No. 200) sieve.
6. Immediately pour the wash water containing the suspended material over the nested sieves; be careful not to pour out the coarser particles or over fill the 75  $\mu$ m (No. 200) sieve.
  7. Add water to cover material remaining in the container, agitate, and repeat Step 6. Continue until the wash water is reasonably clear. Rinse utensil into the washed sample.
  8. Remove the upper sieve, return material retained to the washed sample.
  9. Rinse the material retained on the 75  $\mu$ m (No. 200) sieve until water passing through the sieve is reasonably clear and wetting agent is removed.
  10. Return all material retained on the 75  $\mu$ m (No. 200) sieve to the washed sample by rinsing into the washed sample.
  11. Dry the washed test sample to constant mass according to the FOP for AASHTO T 255. Cool to room temperature. Determine and record the “dry mass after washing.”
  12. Select sieves required by the specification and those necessary to avoid overloading. (See Annex B.) With a pan on bottom, nest the sieves increasing in size starting with the 75  $\mu$ m (No. 200).
  13. Place the test sample, or a portion of the test sample, on the top sieve.
  14. Place sieves in mechanical shaker and shake for the minimum time determined to provide complete separation for the sieve shaker being used (approximately 10 minutes, the time determined by Annex A).



**Note 2:** Excessive shaking (more than 10 minutes) may result in degradation of the sample.

15. Determine and record the individual or cumulative mass retained for each sieve including the pan. Ensure that all material trapped in full openings of the sieves are removed and included in the mass retained.

**Note 3:** For sieves 4.75 mm (No. 4) and larger, check material trapped in less than a full opening by sieving over a full opening. Use coarse wire brushes to clean the 600 µm (No. 30) and larger sieves, and soft bristle brushes for smaller sieves.

16. Perform the *Check Sum* calculation – Verify the *total mass after sieving* of material compared to the *dry mass after washing* is not more than 0.2 percent. Do not use test results for acceptance if the *Check Sum* result is more than 0.2 percent.

17. Calculate the total percentages passing, and the individual or cumulative percentages retained, to the nearest 0.1 percent by dividing the individual sieve masses or cumulative sieve masses by the total mass of the initial dry sample.

18. Apply the Aggregate Correction Factor (ACF) to the calculated percent passing, as required in the FOP for AASHTO T 308 “Correction Factor,” to obtain the reported percent passing.

19. Report total percent passing to 1 percent except report the 75 µm (No. 200) sieve to 0.1 percent.

## Calculations

### Mass verification

$$\text{Mass verification} = \frac{M_{f(T308)} - M_{(T30)}}{M_{f(T308)}} \times 100$$

Where:

$M_{f(T308)}$  = Mass of aggregate remaining in the basket assembly after ignition from the FOP for AASHTO T 308

$M_{(T30)}$  = Mass of aggregate sample obtained from the FOP for AASHTO T 308

### Check Sum

$$\text{check sum} = \frac{\text{dry mass after washing} - \text{total mass after sieving}}{\text{dry mass after washing}} \times 100$$

ASPHALT

WAQTC

FOP AASHTO T 30 (24)

ASPHALT

WAQTC

FOP AASHTO T 30 (24)

**Percent Retained****Individual**

$$IPR = \frac{IMR}{M_{T30}} \times 100$$

**Cumulative**

$$CPR = \frac{CMR}{M_{T30}} \times 100$$

Where:

- IPR = Individual Percent Retained  
 CPR = Cumulative Percent Retained  
 $M_{T30}$  = Total dry sample mass before washing  
 IMR = Individual Mass Retained  
 CMR = Cumulative Mass Retained

**Percent Passing****Individual**

$$PP = PCP - IPR$$

**Cumulative**

$$PP = 100 - CPR$$

Where:

- PP = Calculated Percent Passing  
 PCP = Previous Calculated Percent Passing

ASPHALT

WAQTC

FOP AASHTO T 30 (24)

**Reported Percent Passing**

$$RPP = PP + ACF$$

Where:

RPP = Reported Percent Passing

ACF = Aggregate Correction Factor (if applicable)

**Example****Mass verification**

$$\text{Mass verification} = \frac{2422.5 \text{ g} - 2422.3 \text{ g}}{2422.5 \text{ g}} \times 100 = 0.0\%$$

Given:

$$M_{f(T308)} = 2422.5 \text{ g}$$

$$M_{(T30)} = 2422.3 \text{ g}$$

Dry mass of total sample, before washing ( $M_{T30}$ ): 2422.3 gDry mass of sample, after washing out the 75  $\mu\text{m}$  (No. 200) minus: 2296.2 gAmount of 75  $\mu\text{m}$  (No. 200) minus washed out ( $2422.3 \text{ g} - 2296.2 \text{ g}$ ): 126.1 g**Check sum**

$$\text{check sum} = \frac{2296.2 \text{ g} - 2295.3 \text{ g}}{2296.2 \text{ g}} \times 100 = 0.0\%$$

This is not more than 0.2 percent therefore the results can be used for acceptance purposes.

ASPHALT

WAQTC

FOP AASHTO T 30 (24)

**Percent Retained for the 75 µm (No. 200) sieve**

$$IPR = \frac{63.5 \text{ g}}{2422.3 \text{ g}} \times 100 = 2.6\%$$

*or*

$$CPR = \frac{2289.6 \text{ g}}{2422.3 \text{ g}} \times 100 = 94.5\%$$

**Percent Passing using IPR and PCP for the 75 µm (No. 200) sieve**

$$PP = 8.1\% - 2.6\% = 5.5\%$$

**Percent Passing using CPR for the 75 µm (No. 200) sieve**

$$PP = 100.0\% - 94.5\% = 5.5\%$$

**Reported Percent Passing**

$$RPP = 5.5\% + (-0.6\%) = 4.9\%$$

ASPHALT

WAQTC

FOP AASHTO T 30 (24)

**Individual  
Gradation on All Sieves**

Sieve Size mm (in.)	Individual Mass Retained g (IMR)	Determine IPR by dividing IMR by $M$ and multiplying by 100	Individual Percent Retained (IPR)	Determine PP by subtracting IPR from Previous PP	Percent Passing (PP)	Agg. Corr. Factor from T 308 (ACF)	Reported Percent Passing*
19.0 (3/4)	0		0		100.0		100
12.5 (1/2)	346.9	$\frac{346.9}{2422.3} \times 100 =$	14.3	$100.0 - 14.3 =$	85.7		86
9.5 (3/8)	207.8	$\frac{207.8}{2422.3} \times 100 =$	8.6	$85.7 - 8.6 =$	77.1		77
4.75 (No. 4)	625.4	$\frac{625.4}{2422.3} \times 100 =$	25.8	$77.1 - 25.8 =$	51.3		51
2.36 (No. 8)	416.2	$\frac{416.2}{2422.3} \times 100 =$	17.2	$51.3 - 17.2 =$	34.1		34
1.18 (No. 16)	274.2	$\frac{274.2}{2422.3} \times 100 =$	11.3	$34.1 - 11.3 =$	22.8		23
0.600 (No. 30)	152.1	$\frac{152.1}{2422.3} \times 100 =$	6.3	$22.8 - 6.3 =$	16.5		17
0.300 (No. 50)	107.1	$\frac{107.1}{2422.3} \times 100 =$	4.4	$16.5 - 4.4 =$	12.1		12
0.150 (No. 100)	96.4	$\frac{96.4}{2422.3} \times 100 =$	4.0	$12.1 - 4.0 =$	8.1		8
0.075 (No. 200)	63.5	$\frac{63.5}{2422.3} \times 100 =$	2.6	$8.1 - 2.6 =$	5.5	-0.6 (5.5 - 0.6 =)	4.9
minus 75 $\mu$ m (No. 200) in the pan	5.7						
Total mass after sieving = sum of sieves + mass in the pan = 2295.3 g							
Dry mass of total sample, before washing ( $M_{T30}$ ): 2422.3g							

\* Report total percent passing to 1 percent except report the 75  $\mu$ m (No. 200) sieve to 0.1 percent.

ASPHALT

WAQTC

FOP AASHTO T 30 (24)

**Cumulative  
Gradation on All Sieves**

Sieve Size mm (in.)	Cumulative Mass Retained g (CMR)	Determine CPR by dividing CMR by M and multiplying by 100	Cumulative Percent Retained (CPR)	Determine PP by subtracting CPR from 100.0	Percent Passing (PP)	Agg. Corr. Factor from T 308 (ACF)	Reported Percent Passing*
19.0 (3/4)	0		0.0		100.0		100
12.5 (1/2)	346.9	$\frac{346.9}{2422.3} \times 100 =$	14.3	$100.0 - 14.3 =$	85.7		86
9.5 (3/8)	554.7	$\frac{554.7}{2422.3} \times 100 =$	22.9	$100.0 - 22.9 =$	77.1		77
4.75 (No. 4)	1180.1	$\frac{1180.1}{2422.3} \times 100 =$	48.7	$100.0 - 48.7 =$	51.3		51
2.36 (No. 8)	1596.3	$\frac{1596.3}{2422.3} \times 100 =$	65.9	$100.0 - 65.9 =$	34.1		34
1.18 (No. 16)	1870.5	$\frac{1870.5}{2422.3} \times 100 =$	77.2	$100.0 - 77.2 =$	22.8		23
0.600 (No. 30)	2022.6	$\frac{2022.6}{2422.3} \times 100 =$	83.5	$100.0 - 83.5 =$	16.5		17
0.300 (No. 50)	2129.7	$\frac{2129.7}{2422.3} \times 100 =$	87.9	$100.0 - 87.9 =$	12.1		12
0.150 (No. 100)	2226.1	$\frac{2226.1}{2422.3} \times 100 =$	91.9	$100.0 - 91.9 =$	8.1		8
0.075 (No. 200)	2289.6	$\frac{2289.6}{2422.3} \times 100 =$	94.5	$100.0 - 94.5 =$	5.5	-0.6 (5.5 - 0.6 =)	4.9
minus 75 $\mu$ m (No. 200) in the pan	2295.3						
Total mass after sieving = 2295.3 g							
Dry mass of total sample, before washing ( $M_{T30}$ ): 2422.3g							

\* Report total percent passing to 1 percent except report the 75  $\mu$ m (No. 200) sieve to 0.1 percent.

**Report**

- On forms approved by the agency
- Sample ID
- Depending on the agency, this may include:
  - Individual mass retained on each sieve
  - Individual percent retained on each sieve
  - Cumulative mass retained on each sieve
  - Cumulative percent retained on each sieve
  - Aggregate Correction Factor for each sieve from AASHTO T 308
  - Calculated percent passing each sieve to 0.1 percent
- Percent passing to the nearest 1 percent, except 75  $\mu\text{m}$  (No. 200) sieve to the nearest 0.1 percent.



---

**ANNEX A TIME EVALUATION**

(Mandatory Information)

The minimum time requirement should be evaluated for each shaker at least annually by the following method:

1. Shake the sample over nested sieves for approximately 10 minutes.
2. Provide a snug-fitting pan and cover for each sieve and hold in a slightly inclined position in one hand.
3. Hand-shake each sieve by striking the side of the sieve sharply and with an upward motion against the heel of the other hand at the rate of about 150 times per minute, turning the sieve about one sixth of a revolution at intervals of about 25 strokes.

If more than 0.5 percent by mass of the total sample before sieving passes any sieve after one minute of continuous hand sieving adjust shaker time and re-check.

In determining sieving time for sieve sizes larger than 4.75 mm (No. 4), limit the material on the sieve to a single layer of particles.

**ANNEX B OVERLOAD DETERMINATION**

(Mandatory Information)

- For sieves with openings smaller than 4.75 mm (No. 4), the mass retained on any sieve shall not exceed 7 kg/m<sup>2</sup> (4 g/in<sup>2</sup>) of sieving surface.
- For sieves with openings 4.75 mm (No. 4) and larger, the mass (in kg) shall not exceed the product of 2.5 x (sieve opening in mm) x (effective sieving area). See Table B1.

Additional sieves may be necessary to keep from overloading the specified sieves. The sample may also be sieved in increments or sieves with a larger surface area.

**TABLE B1**  
**Maximum Allowable Mass of Material Retained on a Sieve, g**  
**Nominal Sieve Size, mm (in.)**  
**Exact size is smaller (see AASHTO T 27)**

Sieve Size		203 mm	254 mm	305 mm
mm (in.)		(8 in.)	(10 in.)	(12 in.)
		dia.	dia.	dia.
		Sieving Area m <sup>2</sup> (in <sup>2</sup> )		
		0.0285	0.0457	0.0670
		(44.2)	(70.8)	(103.5)
50	(2)	3600	5700	8400
37.5	(1 1/2)	2700	4300	6300
25.0	(1)	1800	2900	4200
19.0	(3/4)	1400	2200	3200
16.0	(5/8)	1100	1800	2700
12.5	(1/2)	890	1400	2100
9.5	(3/8)	670	1100	1600
6.3	(1/4)	440	720	1100
4.75	(No. 4)	330	540	800
-4.75	(-No. 4)	200	320	470

**PERFORMANCE EXAM CHECKLIST**

**MECHANICAL ANALYSIS OF EXTRACTED AGGREGATE  
FOP FOR AASHTO T 30**

Participant Name \_\_\_\_\_ Exam Date \_\_\_\_\_

Record the symbols “P” for passing or “F” for failing on each step of the checklist.

Procedure Element	Trial 1	Trial 2
1. Total dry mass determined to 0.1 g?	_____	_____
2. Dry mass agrees with sample mass after ignition ( $M_f$ ) from AASHTO T 308 within 0.1 percent?	_____	_____
3. Sample placed in container and covered with water?	_____	_____
4. Wetting agent added?	_____	_____
5. Contents of container agitated vigorously with a utensil?	_____	_____
6. Wash water poured through proper nest of two sieves?	_____	_____
7. Washing continued until wash water is reasonably clear and no wetting agent remaining?	_____	_____
8. Retained material returned to washed sample?	_____	_____
a. Utensil rinsed?		
9. Washed material coarser than 75 $\mu\text{m}$ (No. 200) dried to constant mass at $110 \pm 5^\circ\text{C}$ ( $230 \pm 9^\circ\text{F}$ )?	_____	_____
10. Sample cooled to room temperature?	_____	_____
11. Dry mass after washing determined to 0.1 g?	_____	_____
12. Material sieved on specified sieves?	_____	_____
13. Mass of each fraction of aggregate, including minus 75 $\mu\text{m}$ (No. 200), determined and recorded to 0.1 g?	_____	_____
14. Total mass of material after sieving agrees with mass before sieving to within 0.2 percent?	_____	_____
15. Percent passing each sieve determined correctly to the nearest 0.1 percent?	_____	_____
16. Aggregate correction factor applied, if applicable?	_____	_____
17. Percent passing on each sieve reported correctly to the nearest 1 percent and nearest 0.1 percent on the 75 $\mu\text{m}$ (No. 200)?	_____	_____

Comments: First attempt: Pass \_\_\_\_\_ Fail \_\_\_\_\_ Second attempt: Pass \_\_\_\_\_ Fail \_\_\_\_\_

\_\_\_\_\_

\_\_\_\_\_

\_\_\_\_\_

ASPHALT

WAQTC

FOP AASHTO T 30 (24)

Examiner Signature \_\_\_\_\_ WAQTC #: \_\_\_\_\_

# WSDOT Errata to FOP for AASHTO R 47

## *Reducing Samples of Asphalt Mixtures to Testing Size*

WAQTC FOP for AASHTO R 47 has been adopted by WSDOT with the following changes:

### **Apparatus**

*Include items below:*

- Mechanical Splitter Type A (Quartermaster): having four equal-width chutes discharging into four appropriately sized sample receptacles. Splitter is to be equipped with a receiving hopper that will hold the sample until the release lever is activated with four sample receptacles of sufficient capacity to accommodate the reduced portion of the Asphalt Mixture sample from the mechanical splitter. Refer to AASHTO R 47, Figures 1 through 3, for configuration and required dimensions of the mechanical splitter.

### **Selection of Procedure (Method)**

*Include items below:*

- **Mechanical Splitter Method**
  - Type A (Quartermaster)
  - Type B (Riffle Splitter)

### **Procedure**

*Include items below:*

#### ***Mechanical Splitter Type A (Quartermaster)***

**Note:** This method is to be used for Initial Reduction of Field Sample ONLY.

1. Clean the splitter and apply a light coating of approved release agent to the surfaces that will contact Asphalt Mixture.
2. Close and secure hopper gates.
3. Place the four sample receptacles in the splitter so that there is no loss of material.
4. Remove the sample from the agency-approved container(s) and place in the mechanical splitter hopper. Avoid segregation, loss of Asphalt Mixture or the accidental addition of foreign material.
5. Release the handle, allowing the Asphalt Mixture to drop through the divider chutes and discharge into the four receptacles.
6. Any Asphalt Mixture that is retained on the surface of the splitter shall be removed and placed into the appropriate receptacle.
7. Close and secure the hopper gates.
8. Reduce the remaining Asphalt Mixture as needed by this method or a combination of the following methods as approved by the agency.

9. Combine the material contained in the receptacles from opposite corners and repeat the splitting process until an appropriate sample size is obtained.
10. Retain and properly identify the remaining unused portion of the asphalt mixture sample for further testing if required by the agency.

### **Quartering and Sectoring Methods**

**Note:** If this method is being used for Initial Reduction of Field Sample, step 3 “turning the entire sample over a minimum of 4 times” for safety reasons is not required.

### **Procedure**

*Include items below:*

### **Sample Identification**

1. Each sample submitted for testing shall be accompanied by a transmittal letter completed in detail. Include the contract number, acceptance and mix design verification numbers, mix ID.
2. Samples shall be submitted in standard sample boxes, secured to prevent contamination and spillage.
3. Sample boxes shall have the following information inscribed with indelible-type marker: Contract number, acceptance and mix design verification numbers, mix ID.
4. The exact disposition of each quarter of the original field sample shall be determined by the agency.

## REDUCING SAMPLES OF ASPHALT MIXTURES TO TESTING SIZE FOP FOR AASHTO R 47

### Scope

This procedure covers sample reduction of asphalt mixtures to testing size in accordance with AASHTO R 47-23. The reduced portion is to be representative of the original sample.

### Apparatus

- Thermostatically controlled oven capable of maintaining a temperature of at least 110°C (230°F) or high enough to heat the material to a pliable condition for splitting.
- Non-contact temperature measuring device.
- Metal spatulas, trowels, metal straightedges, drywall taping knives, or a combination thereof; for removing asphalt mixture samples from the quartering device, cleaning surfaces used for splitting, etc.
- Square-tipped, flat-bottom scoop, shovel, or trowel for mixing asphalt mixture before quartering.
- Miscellaneous equipment including hot plate, non-asbestos heat-resistant gloves or mittens, pans, buckets, and cans.
- Sheeting: Non-stick heavy paper or other material as approved by the agency.
- Agency-approved release agent, free of solvent or petroleum-based material that could affect asphalt binder.
- Mechanical Splitter Type B (Riffle): having a minimum of eight equal-width chutes discharging alternately to each side with a minimum chute width of at least 50 percent larger than the largest particle size. A hopper or straight-edged pan with a width equal to or slightly smaller than the assembly of chutes in the riffle splitter to permit uniform discharge of the asphalt mixture through the chutes without segregation or loss of material. Sample receptacles of sufficient width and capacity to receive the reduced portions of asphalt mixture from the splitter without loss of material.
- Quartering Template: formed in the shape of a 90-degree cross with equal sides that exceed the diameter of the flattened cone of material sufficient to allow complete separation of the quartered sample. The height of the sides must be sufficient to extend above the thickness of the flattened cone of the sample to be quartered. Manufactured of metal that will withstand heat and use without deforming.
- Non-stick mixing surface that is hard, heat-resistant, clean, level, and large enough to permit asphalt mixture samples to be mixed without contamination or loss of material.

### Sampling

Obtain samples according to the FOP for AASHTO R 97.

## Sample Preparation

The sample must be warm enough to separate. If not, warm in an oven until it is sufficiently soft to mix and separate easily. Do not exceed either the temperature or time limits specified in the test method(s) to be performed.

## Selection of Procedure (Method)

Refer to agency requirements when determining the appropriate method(s) of sample reduction. In general, the selection of a particular method to reduce a sample depends on the initial size of the sample vs. the size of the sample needed for the specific test to be performed. It is recommended that, for large amounts of material, the initial reduction be performed using a mechanical splitter. This decreases the time needed for reduction and minimizes temperature loss. Further reduction of the remaining asphalt mixture may be performed by a combination of the following methods, as approved by the agency.

The methods for reduction are:

- Mechanical Splitter Type B (Riffle) Method
- Quartering and Sectoring Methods
  - Quartering
  - Sectoring
- Incremental Method

## Procedure

When heating of the equipment is desired, it shall be heated to a temperature not to exceed the maximum mixing temperature of the job mix formula (JMF).

### Mechanical Splitter Type B (Riffle) Method

1. Clean the splitter and apply a light coating of agency-approved release agent to the surfaces that will come in contact with asphalt mixture (hopper or straight-edged pan, chutes, receptacles).
2. Place two empty receptacles under the splitter.
3. Carefully empty the asphalt mixture from the agency-approved container(s) into the hopper or straight-edged pan without loss of material. Uniformly distribute from side to side of the hopper or pan.
4. Discharge the asphalt mixture at a uniform rate, allowing it to flow freely through the chutes.
5. Any asphalt mixture that is retained on the surface of the splitter shall be removed and placed into the appropriate receptacle.
6. Reduce the remaining asphalt mixture as needed by this method or a combination of the following methods as approved by the agency.



7. Using one of the two receptacles containing asphalt mixture, repeat the reduction process until the asphalt mixture contained in one of the two receptacles is the appropriate size for the required test.
8. After each split, remember to clean the splitter hopper and chute surfaces if needed.
9. Retain and properly identify the remaining unused asphalt mixture sample for further testing if required by the agency.

### **Quartering and Sectoring Methods**

1. If needed, apply a light coating of agency-approved release agent to quartering template.
2. Place the sample from the agency approved container(s) into a conical pile on a hard, “non-stick,” clean, level surface where there will be neither a loss of material nor the accidental addition of foreign material. The surface can be made non-stick by the application of an agency-approved release agent, or sheeting.
3. Mix the material thoroughly by turning the entire sample over a minimum of four times with a flat-bottom scoop; or by alternately lifting each corner of the sheeting and pulling it over the sample diagonally toward the opposite corner, causing the material to be rolled. Create a conical pile by either depositing each scoop or shovelful of the last turning on top of the preceding one or lifting both opposite corners.
4. Flatten the conical pile to a uniform diameter and thickness where the diameter is four to eight times the thickness. Make a visual observation to ensure that the material is homogeneous.
5. Divide the flattened cone into four equal quarters using the quartering template or straightedges assuring complete separation.
6. Reduce to appropriate sample mass by quartering or sectoring.

### **Quartering**

- a. Remove diagonally opposite quarters, including all the fine material, and place in a container to be retained.
- b. Remove the quartering template, if used.
- c. Combine the remaining quarters.
- d. If further reduction is necessary, repeat Quartering Method Steps 3 through 6.
- e. Repeat until appropriate sample mass is obtained. The final sample must consist of the two remaining diagonally opposite quarters.
- f. Retain and properly identify the remaining unused portion of the asphalt mixture sample for further testing if required by the agency.

**Sectoring**

- a. Using a straightedge, obtain a sector by slicing through a quarter of the asphalt mixture from the center point to the outer edge of the quarter.
- b. Pull or drag the sector from the quarter with two straight edges or hold one edge of the straightedge in contact with quartering device.
- c. Remove an approximately equal sector from the diagonally opposite quarter and combine.
- d. If necessary, repeat until the appropriate sample mass has been obtained.
- e. Continue sectoring with the unused portion of the asphalt mixture until samples have been obtained for all required tests.
- f. Retain and properly identify the remaining unused portion of the asphalt mixture sample for further testing if required by the agency.

**Incremental Method**

1. Cover a hard, clean, level surface with sheeting. This surface shall be large enough that there will be neither a loss of material nor the accidental addition of foreign material.
2. Place the sample from the agency approved container(s) into a conical pile on that surface.
3. Mix the material thoroughly by turning the entire sample over a minimum of four times:
  - a. Use a flat-bottom scoop; or
  - b. Alternately lift each corner of the sheeting and pull it over the sample diagonally toward the opposite corner, causing the material to be rolled.
4. Create a conical pile by either depositing each scoop or shovelful of the last turning on top of the preceding one or lifting both opposite corners.
5. Grasp the sheeting and roll the conical pile into a cylinder (loaf), then flatten the top. Make a visual observation to determine that the material is homogenous.
6. Remove one quarter of the length of the loaf and place in a container to be saved by either:
  - a. Pull sheeting over edge of counter and drop material into container.
  - b. Use a straightedge at least as wide as the full loaf to slice off material and place into container.
7. Obtain an appropriate sample mass for the test to be performed; by either:
  - a. Pull sheeting over edge of counter and drop cross sections of the material into container until proper sample mass has been obtained.
  - b. Use a straightedge at least as wide as the full loaf to slice off cross sections of the material until proper sample mass has been obtained and place into container.

ASPHALT

WAQTC

FOP AASHTO R 47 (23)

*Note 1:* When reducing the sample to test size it is advisable to take several small increments, determining the mass each time until the proper minimum size is achieved. Unless the sample size is grossly in excess of the minimum or exceeds the maximum test size, use the sample as reduced for the test.

8. Repeat Step 7 until all the samples for testing have been obtained or until the final quarter of the original loaf is reached.
9. Retain and properly identify the remaining unused portion of the asphalt mixture sample for further testing if required by the agency.

ASPHALT

WAQTC

FOP AASHTO R 47 (23)

**PERFORMANCE EXAM CHECKLIST**

**REDUCING SAMPLES OF ASPHALT MIXTURES TO TESTING SIZE  
FOP FOR AASHTO R 47**

Participant Name \_\_\_\_\_ Exam Date \_\_\_\_\_

Record the symbols “P” for passing or “F” for failing on each step of the checklist.

<b>Procedure Element</b>	<b>Trial 1</b>	<b>Trial 2</b>
1. Sample made soft enough to separate easily without exceeding temperature limits?	_____	_____
2. Splitting apparatus and tools, if preheated, not exceeding maximum mixing temperature from the JMF?	_____	_____
<b>Mechanical Splitter Type B (Riffle) Method</b>		
1. Splitter cleaned, and surfaces coated with release agent?	_____	_____
2. Two empty receptacles placed under splitter?	_____	_____
3. Sample placed in hopper or straight edged pan without loss of material and uniformly distributed from side to side?	_____	_____
4. Material discharged across chute assembly at controlled rate allowing free flow of asphalt mixture through chutes?	_____	_____
5. Splitter surfaces cleaned of all retained asphalt mixture allowing it to fall into appropriate receptacles?	_____	_____
6. Further reduction with the riffle splitter:		
a. Material from one receptacle discharged across chute assembly at controlled rate, allowing free flow of asphalt mixture through chutes?	_____	_____
b. Splitting process continued until appropriate sample mass obtained, with splitter surfaces cleaned of all retained asphalt mixture after every split?	_____	_____
7. Remaining unused asphalt mixture stored in suitable container, properly labeled?	_____	_____

**OVER**

<b>Procedure Element</b>	<b>Trial 1</b>	<b>Trial 2</b>
<b>Quartering Method</b>		
1. Sample placed in a conical pile on a hard, non-stick, heat-resistant splitting surface such as metal or sheeting?	_____	_____
2. Sample mixed by turning the entire sample over a minimum of 4 times?	_____	_____
3. Conical pile formed and then flattened uniformly to diameter equal to about 4 to 8 times thickness?	_____	_____
4. Sample divided into 4 equal quarters either with a metal quartering template or straightedges such as drywall taping knives?	_____	_____
5. Quartering:		
a. Two diagonally opposite quarters removed and placed in a container to be retained?	_____	_____
b. Two other diagonally opposite quarters combined?	_____	_____
c. Process continued, if necessary, until appropriate sample mass has been achieved?	_____	_____
6. Sectoring:		
a. Using two straightedges or a quartering device and one straightedge, sector obtained from one of the quarters from the center point to the outer edge of the quarter?	_____	_____
b. Equal sector obtained taken from the diagonally opposite quarter?	_____	_____
7. Increments combined to produce appropriate sample mass?	_____	_____
8. Remaining unused asphalt mixture stored in suitable container, properly labeled?	_____	_____

**OVER**

ASPHALT

WAQTC

FOP AASHTO R 47 (23)

**Procedure Element**

**Trial 1    Trial 2**

**Incremental Method**

- 1. Sample placed on hard, non-stick, heat-resistant splitting surface covered with sheeting? \_\_\_\_\_
- 2. Sample mixed by turning the entire sample over a minimum of 4 times? \_\_\_\_\_
- 3. Conical pile formed? \_\_\_\_\_
- 4. Asphalt mixture rolled into loaf and then flattened? \_\_\_\_\_
- 5. The first quarter of the loaf removed by slicing off or dropping off edge of counter and set aside? \_\_\_\_\_
- 6. Proper sample mass sliced off or dropped off edge of counter into sample container? \_\_\_\_\_
- 7. Process continued until all samples are obtained or final quarter is remaining? \_\_\_\_\_
- 8. All remaining unused asphalt mixture stored in suitable container, properly labeled? \_\_\_\_\_

Comments:      First attempt:    Pass\_\_\_\_Fail\_\_\_\_      Second attempt:    Pass\_\_\_\_Fail\_\_\_\_

---



---



---



---



---



---



---



---



---



---

**Examiner Signature** \_\_\_\_\_ **WAQTC #:** \_\_\_\_\_

ASPHALT

WAQTC

FOP AASHTO R 47 (23)



# WSDOT Errata to FOP for AASHTO R 66

## *Sampling Asphalt Materials*

WAQTC FOP for AASHTO R 66 has been adopted by WSDOT with the following changes:

### **Containers**

Include sentence below:

Emulsified asphalt: Use wide-mouth plastic jars with screw caps. Protect the samples from freezing since water is a part of the emulsion. The sample container should be completely filled to minimize a skin formation on the sample. Place tape around the seam of the cap to keep the cap from loosening and spilling the contents.



## SAMPLING ASPHALT MATERIALS FOP FOR AASHTO R 66

### Scope

This procedure covers obtaining samples of liquid asphalt materials in accordance with AASHTO R 66-16. Sampling of solid and semi-solid asphalt materials – included in AASHTO R 66 – is not covered here.

Agencies may be more specific on exactly who samples, where to sample, and what type of sampling device to use.

**Warning:** Always use appropriate safety equipment and precautions for hot liquids.

### Terminology

- Asphalt binder: Asphalt cement or modified asphalt cement that binds the aggregate particles into a dense mass.
- Asphalt emulsion: A mixture of asphalt binder and water.
- Cutback asphalt: Asphalt binder that has been modified by blending with a chemical solvent.

### Containers

Sample containers must be new, and the inside may not be washed or rinsed. The outside may be wiped with a clean, dry cloth.

All samples shall be put in 1 L (1 qt) containers and properly identified on the outside of the container with contract number, date sampled, data sheet number, brand and grade of material, and sample number. Include lot and subplot numbers when appropriate.

- Emulsified asphalt: Use wide-mouth plastic jars with screw caps. Protect the samples from freezing since water is a part of the emulsion. The sample container should be completely filled to minimize a skin formation on the sample.
- Asphalt binder and cutbacks: Use metal cans

**Note:** The sample container shall not be submerged in solvent, nor shall it be wiped with a solvent saturated cloth. If cleaning is necessary, use a clean dry cloth.

**Procedure**

1. Coordinate sampling with contractor or supplier.
2. Allow a minimum of 4 L (1 gal) to flow before obtaining samples.
3. Obtain samples of:
  - Asphalt binder from the line between the storage tank and the mixing plant while the plant is in operation, or from the delivery truck.
  - Cutback and emulsified asphalt from distributor spray bar or application device; or from the delivery truck before it is pumped into the distributor. Sample emulsified asphalt at delivery or before dilution.

**Report**

- On standard agency forms
- Sample ID
- Date
- Time
- Location
- Quantity represented

**PERFORMANCE EXAM CHECKLIST (ORAL)**

**SAMPLING ASPHALT MATERIALS  
FOP FOR AASHTO R 66**

Participant Name \_\_\_\_\_ Exam Date \_\_\_\_\_

Record the symbols "P" for passing or "F" for failing on each step of the checklist.

<b>Procedure Element</b>	<b>Trial 1</b>	<b>Trial 2</b>
<b>1. Describe the container that is used to sample Performance Graded Asphalt binder and Cutbacks.</b>		
a. Metal can	_____	_____
b. New	_____	_____
c. 1 L (1 qt) in size	_____	_____
<b>2. Describe the container that is used to sample Emulsified Asphalt.</b>		
a. Screw capped wide mouth plastic jar.	_____	_____
b. New.	_____	_____
c. 1 L (1 qt).	_____	_____
<b>3. How much material must be wasted before a sample can be obtained?</b>		
a. A minimum of 4 L (1 gal).	_____	_____
<b>4. Where is Performance Graded Asphalt binder sampled from?</b>		
a. At the Hot plant / Mixing plant.	_____	_____
b. In the line between storage tank and mixing plant.	_____	_____
c. Delivery truck.	_____	_____
<b>5. Where is Cutback binder sampled from?</b>		
a. Spray bar or application device.	_____	_____
b. Delivery truck.	_____	_____
<b>6. Where is Emulsified Asphalt binder sampled from?</b>		
a. Prior to dilution Spray bar or application device.	_____	_____
b. Prior to dilution the delivery truck.	_____	_____
<b>7. How much Emulsified Asphalt needs to be in the container?</b>		
a. Filled completely.	_____	_____

**OVER**

**Procedure Element**

**Trial 1 Trial 2**

**8. Describe what needs to be done to the Emulsified Asphalt sample container before shipping.**

a. Place tape around the seam of the cap / lid.

\_\_\_\_\_

b. Mark / Label the container with the required identification.

\_\_\_\_\_

**9. During transport what must be done with the Emulsified Asphalt sample.**

a. Protected from freezing

\_\_\_\_\_

Comments: First attempt: Pass\_\_\_\_Fail\_\_\_\_ Second attempt: Pass\_\_\_\_Fail\_\_\_\_

\_\_\_\_\_

\_\_\_\_\_

\_\_\_\_\_

Examiner Signature \_\_\_\_\_ WAQTC #: \_\_\_\_\_

## DEVELOPING MOISTURE-DENSITY RELATIONS FOP FOR AASHTO R 75

### Scope

This procedure provides a method to develop soils density-relations in accordance with AASHTO R 75-24 using multiple moisture-density relations developed using the same method, A, B, C, or D, from the FOP for AASHTO T 99/T 180.

All curves used in a group must be developed using a single Method: A, B, C, or D of a procedure for AASHTO T 99 or T 180. See the FOP for AASHTO T 99/T 180.

### Terminology

**soil moisture-density relations** — a group of soil moisture-density relations (commonly known as a family of curves) determined using AASHTO T 99 or T 180, which reveal certain similarities and trends characteristic of the soil type and source.

**spine** — smooth line extending through the point of maximum density and optimum moisture content of a group of moisture-density curves.

### Procedure

1. Sort the curves by Method (A, B, C, or D of the FOP for T 99/T 180). At least three curves are required per group.
2. Select the highest and lowest maximum dry densities from those selected to assist in determining the desired scale of the subsequent graph.
3. Plot the maximum density and optimum moisture points of the selected curves on the graph.
4. Draw a smooth, “best fit,” curved line through the points creating the spine of the soil moisture-density relations.
5. Remove maximum density and optimum moisture points that were not used to establish the spine.
6. Add the moisture-density curves associated with the points that were used to establish the spine. It is not necessary to include the portion of the curves over optimum moisture.

**Note 1**—Intermediate curves using slopes similar to those of the original moisture-density curves may be included when maximum density points are more than 2.0 lb/ft<sup>3</sup> apart. Intermediate curves are indicated by a dashed line.

7. Plot the 80 percent of optimum moisture range when desired:
  - a. Using the optimum moisture of an existing curve, calculate 80 percent of optimum moisture and plot this value on the curve. Repeat for each curve in the group.
  - b. Draw a smooth, “best fit,” curved line connecting the 80 percent of optimum moisture points plotted on the curves that parallel the spine.

**Calculations**

Calculate 80 percent of optimum moisture of each curve:

Example:

Optimum moisture of the highest density curve = 14.6%

$$80\% \text{ point} = \frac{80}{100} \times 14.6\% = 11.7\%$$

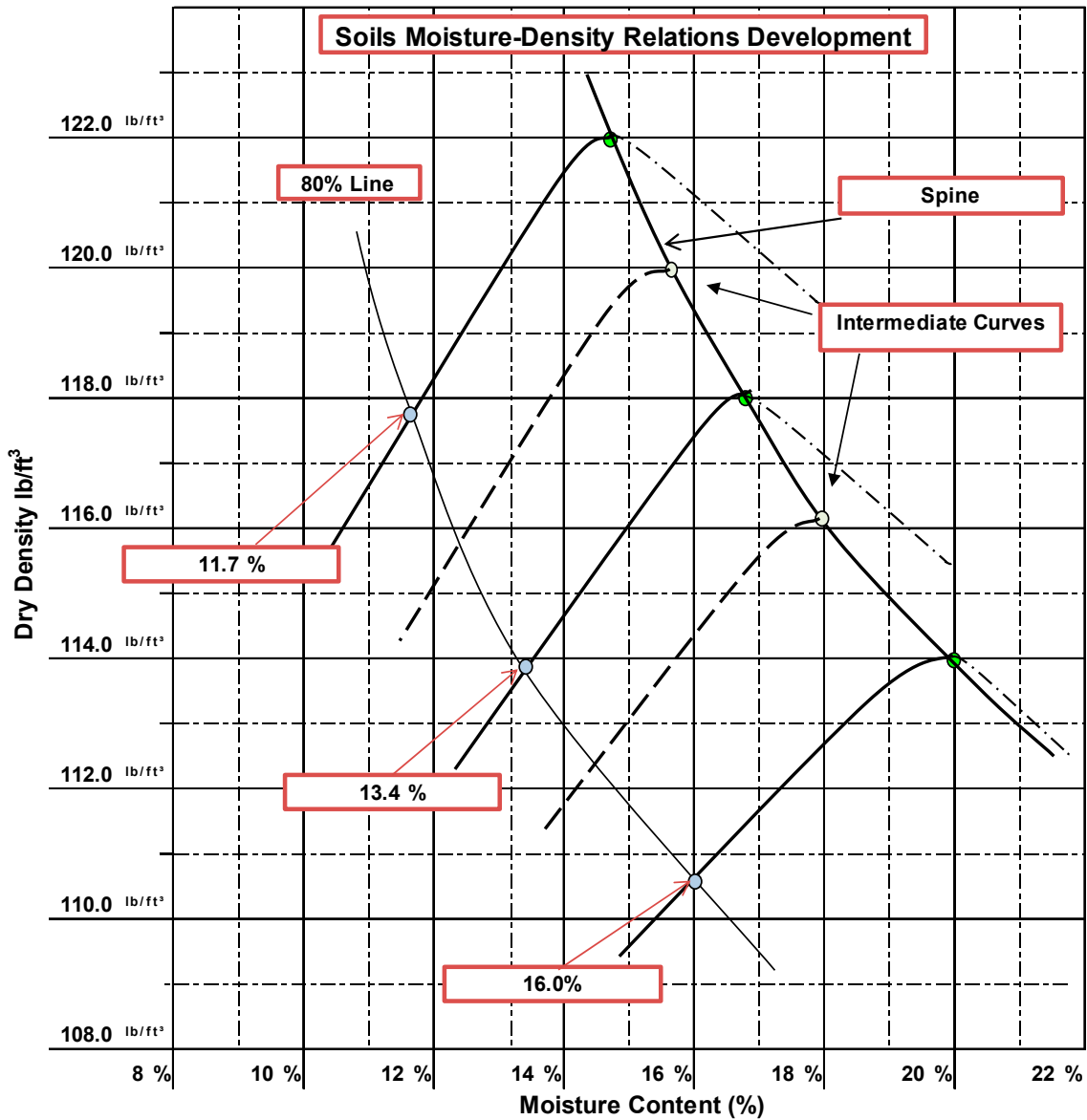



**PERFORMANCE EXAM CHECKLIST**

**DEVELOPING A MOISTURE-DENSITY RELATIONS  
FOP FOR AASHTO R 75**

Participant Name \_\_\_\_\_ Exam Date \_\_\_\_\_

Record the symbols "P" for passing or "F" for failing on each step of the checklist.

Procedure Element	Trial 1	Trial 2
1. Curves sorted by method and procedure (A, B, C, or D of the FOP for T 99/T 180)?	_____	_____
a. At least three curves per group?	_____	_____
b. Curves within a group are similar soil type and from same source?	_____	_____
2. Maximum density and optimum moisture points plotted on the graph?	_____	_____
3. Spine drawn correctly?	_____	_____
4. Maximum density and optimum moisture points removed that were not used for the spine?	_____	_____
5. Moisture-density curves added?	_____	_____
6. Optimum moisture range?	_____	_____
a. 80 percent of optimum moisture calculated for each curve?	_____	_____
b. Curved line through 80 percent of optimum moisture drawn correctly?	_____	_____

Comments: First attempt: Pass\_\_\_\_Fail\_\_\_\_ Second attempt: Pass\_\_\_\_Fail\_\_\_\_

\_\_\_\_\_

\_\_\_\_\_

\_\_\_\_\_

\_\_\_\_\_

\_\_\_\_\_

\_\_\_\_\_

\_\_\_\_\_

\_\_\_\_\_

\_\_\_\_\_

Examiner Signature \_\_\_\_\_ WAQTC #: \_\_\_\_\_

EMBANKMENT AND BASE

WAQTC

FOP AASHTO R 75 (24)

## **WSDOT Errata to FOP for AASHTO R 76**

### ***Reducing Samples of Aggregate to Testing Size***

WAQTC FOP for AASHTO R 76 has been adopted by WSDOT with the following changes:

**Procedure**

**Method A – Mechanical Splitter**

**Mechanical Splitter Check - *Step not required by WSDOT***



## REDUCING SAMPLES OF AGGREGATE TO TESTING SIZE FOP FOR AASHTO R 76

### Scope

This procedure covers the reduction of samples to the appropriate size for testing in accordance with AASHTO R 76-23. Techniques are used that minimize variations in characteristics between test samples and field samples. Method A (Mechanical Splitter) and Method B (Quartering) are covered.

This FOP applies to fine aggregate (FA), coarse aggregate (CA), and combinations of the two (FA / CA) and may also be used on soils.

### Terminology

Saturated Surface-Dry (SSD) – condition of an aggregate particle when the permeable voids are filled with water, but no water is present on exposed surfaces.

*Note 1:* As a quick approximation, if the fine aggregate will retain its shape when molded in the hand, it may be considered wetter than saturated surface-dry.

### Apparatus

#### Method A – Mechanical Splitter

Splitter chutes:

- Even number of equal width chutes
- Discharge alternately to each side
- Minimum of 8 chutes total for CA and FA / CA, 12 chutes total for FA
- Width:
  - Minimum 50 percent larger than largest particle
  - Maximum chute width of 19 mm (3/4 in.) for fine aggregate passing the 9.5 mm (3/8 in.) sieve
- Feed Control:
  - Hopper or straightedge pan with a width equal to or slightly less than the overall width of the assembly of chutes
  - Capable of feeding the splitter at a controlled rate
- Splitter receptacles / pans:
  - Capable of holding two halves of the sample following splitting

The splitter and accessory equipment shall be so designed that the sample will flow smoothly without restriction or loss of material.

**Method B – Quartering and Sectoring**

- Straightedge scoop, shovel, or trowel
- Broom or brush
- Stick or pipe
- Tarp: A tear resistant rectangular tarp,, appropriate for the amount and size of the material being reduced.
- Quartering Template: Formed in the shape of a 90-degree cross with equal length sides that exceed the diameter of the flattened pile of material sufficient to allow complete separation of the quartered sample. The height of the sides must be sufficient to extend above the thickness of the flattened pile of the sample to be quartered.

**Method Selection**

Selecting the method of sample reduction depends on

- The type of material: fine aggregate (FA), coarse aggregate (CA), and combinations of the two (FA / CA)
- The moisture content: drier than saturated surface-dry (SSD), SSD, or wetter than SSD.

*Note 2:* To use Method A on samples of FA and CA/FA that are at SSD or wetter, the entire sample may be dried – using temperatures that do not exceed those specified for any of the tests contemplated – and then reduced.

Select from the following methods based on the material type and moisture condition.

**Method A Mechanical**

- CA
- FA/CA drier than SSD
- FA drier than SSD

**Method B Quartering**

- CA
- FA/CA
- FA at SSD or wetter

**Method B Sectoring**

- FA at SSD or wetter

**Table 1**

	<b>Drier than SSD</b>	<b>SSD or Wetter</b>
Fine Aggregate (FA)	Method A Mechanical	Method B Quartering Method B Sectoring
Mixture of FA/CA	Method A Mechanical Method B Quartering	Method B Quartering
Coarse Aggregate (CA)	Method A Mechanical Method B Quartering	Method A Mechanical Method B Quartering

**Procedure****Method A – Mechanical Splitter**

1. Place two clean empty receptacles under the splitter.
2. Empty the sample into the hopper or pan without loss of material.
3. Uniformly distribute the material in the hopper or pan from edge to edge so that approximately equal amounts flow through each chute.
4. Discharge the material at a uniform rate, allowing it to flow freely through the chutes.
5. Remove any material retained on the surface of the splitter and place into the appropriate receptacle.
6. Using one of the two receptacles containing material, repeat Steps 1 through 6 until the material in one of the two receptacles is the appropriate sample size for the required test.
7. Retain and properly identify the remaining unused sample for further testing if required.

**Mechanical Splitter Check**

- Determine the mass of each reduced portion. If the percent difference of the two masses is greater than 5 percent, corrective action must be taken.

### Calculation

$$\frac{\text{Smaller Mass}}{\text{Larger Mass}} = \text{Ratio} \quad (1 - \text{ratio}) \times 100 = \% \text{ Difference}$$

Splitter check: 5127 g total sample mass

Splitter pan #1: 2583 g

Splitter pan #2: 2544 g

$$\frac{2544 \text{ g}}{2583 \text{ g}} = 0.985 \quad (1 - 0.985) \times 100 = 1.5\%$$

### Alternative to Mechanical Splitter Check

- In lieu of determining the mass of each reduced portion, use the method illustrated in Figure 1 or 2 during reduction.

**Figure 1**

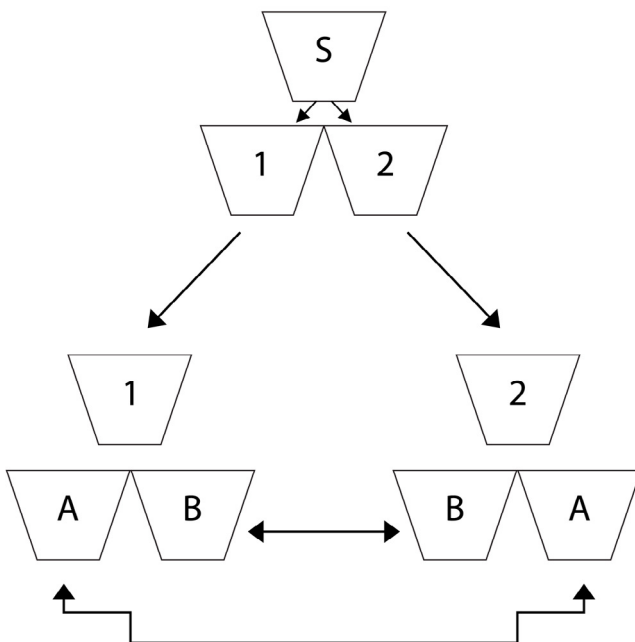

- Sample (S) is an amount greater than or equal to twice the mass needed for testing. Sample (S) is reduced in a mechanical splitter to yield parts (1) and (2).
- Part (1) is further reduced yielding (A) and (B) while part (2) is reduced to yield (B) and (A).
- Final testing sample is produced by combining alternate pans, i.e. A/A or B/B only.



Figure 2

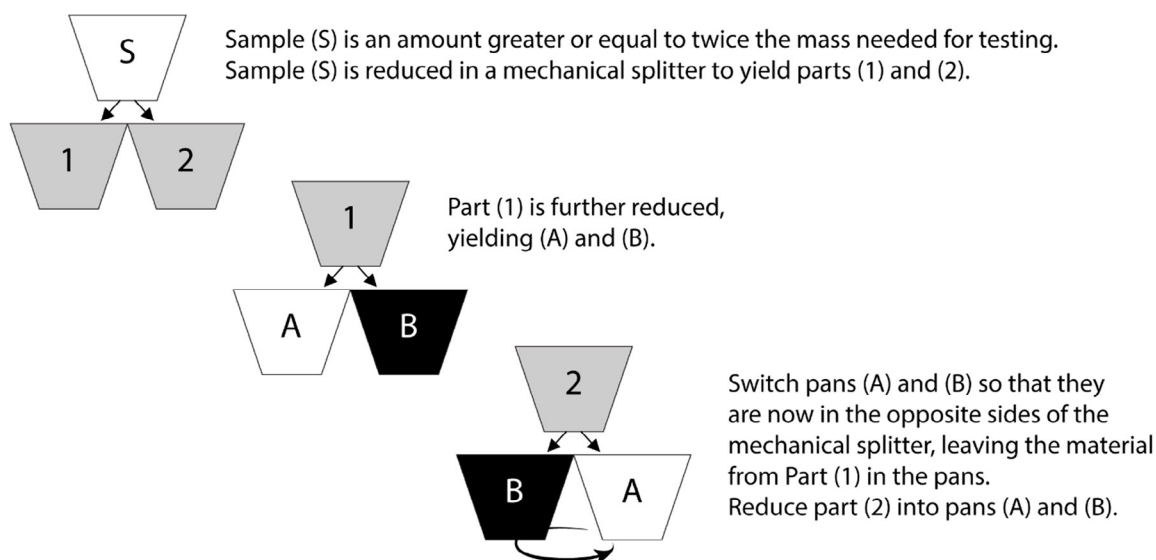

## Method B

### Method B Quartering

Use either of the following two procedures or a combination of both.

#### Surface

1. Place the sample on a hard, clean, level surface where there will be neither loss of material nor the accidental addition of foreign material.
2. Mix the material thoroughly by turning the entire sample over a minimum of four times. With the last turning, shovel the entire sample into a conical pile by depositing each shovelful on top of the preceding one.
3. Flatten the conical pile to a uniform thickness and diameter by pressing down with a shovel. The diameter should be four to eight times the thickness.
4. Divide the flattened pile into four approximately equal quarters with a shovel or trowel.
5. Remove two diagonally opposite quarters, including all fine material, and brush the cleared spaces clean.
6. Successively mix and quarter the remaining material until the sample is reduced to the desired size.
7. The final test sample consists of two diagonally opposite quarters.

**Tarp**

1. Place the sample on the tarp.
2. Mix the material thoroughly a minimum of four times by pulling each corner of the tarp horizontally over the sample toward the opposite corner. After the last turn, form a conical pile.
3. Flatten the conical pile to a uniform thickness and diameter by pressing down with a shovel. The diameter should be four to eight times the thickness.
4. Divide the flattened pile into four approximately equal quarters with a shovel or trowel or insert a stick or pipe beneath the tarp and under the center of the pile, then lift both ends of the stick, dividing the sample into two roughly equal parts. Remove the stick leaving a fold of the tarp between the divided portions. Insert the stick under the center of the pile at right angles to the first division and again lift both ends of the stick, dividing the sample into four roughly equal quarters.
5. Remove two diagonally opposite quarters, being careful to clean the fines from the tarp.
6. Successively mix and quarter the remaining material until the sample size is reduced to the desired size.
7. The final test sample consists of two diagonally opposite quarters.

**Method B Sectoring**

1. Place the sample on a hard, clean, level surface or tarp where there will be neither loss of material nor the accidental addition of foreign material.
2. Mix the material thoroughly a minimum of four times by one of the following:
  - a. Turning the entire sample over with a shovel or scoop. On the final turning, shovel the entire sample into a conical pile by depositing each shovelful on top of the preceding one.
  - b. Pulling each corner of the tarp horizontally over the sample toward the opposite corner. After the final turn, form a conical pile.
3. Flatten the conical pile to a uniform thickness and diameter by pressing down with a shovel or scoop. The diameter should be four to eight times the thickness.
4. Divide the flattened pile into four approximately equal quarters using a quartering template, straightedge, shovel, or trowel, assuring complete separation.
5. Using a straightedge, obtain a sector by slicing through a quarter of the material from the center point to the outer edge of the quarter.

6. Pull or drag the sector from the quarter with two straight edges or hold one edge of the straightedge in contact with quartering device.
7. Remove an equal sector from the diagonally opposite quarter and combine to create the appropriate sample mass.
8. Continue obtaining sectors from diagonally opposite quarters until the required sample size has been obtained for all required tests.

| AGGREGATE

WAQTC

FOP AASHTO R 76 (24)

| 38\_R76\_short\_24\_errata

Aggregate 10-8

Pub. October 2024 (v. 2025)

**PERFORMANCE EXAM CHECKLIST****REDUCING SAMPLES OF AGGREGATE TO TESTING SIZE  
FOP FOR AASHTO R 76**

Participant Name \_\_\_\_\_ Exam Date \_\_\_\_\_

Record the symbols "P" for passing or "F" for failing on each step of the checklist.

**Trial 1    Trial 2****Method A - Splitting**

- |   |       |       |
|---|-------|-------|
| 1. Chutes appropriate size and number?                                  | _____ | _____ |
| 2. Material spread uniformly on feeder?                                 | _____ | _____ |
| 3. Rate of feed slow enough so that sample flows freely through chutes? | _____ | _____ |
| 4. Material in one pan re-split until desired mass is obtained?         | _____ | _____ |
| 5. Mechanical splitter checked or alternative used?                     | _____ | _____ |

**Method B - Quartering**

- |   |       |       |
|---|-------|-------|
| 1. Sample placed on a tarp or clean, hard, and level surface?                                   | _____ | _____ |
| 2. Mixed by turning over 4 times with shovel or by pulling the tarp horizontally over pile?     | _____ | _____ |
| 3. Conical pile formed without loss of material?  | _____ | _____ |
| 4. Pile flattened to uniform thickness and diameter?  | _____ | _____ |
| 5. Diameter equal to about 4 to 8 times thickness?  | _____ | _____ |
| 6. Divided into 4 equal portions without loss of material?                                      | _____ | _____ |
| a. Using a shovel or trowel?  |       |       |
| b. Placing stick or pipe under the tarp?  |       |       |
| c. Using quartering template?   |       |       |
| 7. Quartering   |       |       |
| a. Two diagonally opposite quarters, including all fine material, removed?                      | _____ | _____ |
| b. Process continued until desired sample size is obtained when two opposite quarters combined? | _____ | _____ |

**OVER**

8. Sectoring

- a. Using two straightedges or a quartering device and one straightedge, sector obtained from one of the quarters from the center point to the outer edge of the quarter? \_\_\_\_\_
- b. Equal sector obtained taken from the diagonally opposite quarter? \_\_\_\_\_

9. Increments combined to produce appropriate sample mass? \_\_\_\_\_

Comments: First attempt: Pass\_\_\_\_Fail\_\_\_\_\_ Second attempt: Pass\_\_\_\_Fail\_\_\_\_\_

\_\_\_\_\_

\_\_\_\_\_

\_\_\_\_\_

\_\_\_\_\_

\_\_\_\_\_

Examiner Signature \_\_\_\_\_ WAQTC #: \_\_\_\_\_

## VACUUM DRYING COMPACTED ASPHALT SPECIMENS FOP FOR AASHTO R 79

### Scope

This practice covers the process of drying compacted field and laboratory specimens using a vacuum device in accordance with AASHTO R 79-22.

### Overview

The specimens dried by this procedure remain near room temperature, which helps in maintaining specimen integrity during the drying process and allows the operators to run repeated tests on the same sample, if necessary.

Specimens are kept and stored at temperatures above 15°C (60°F) and below 54°C (130°F).

This practice can also be used for drying other construction materials such as concrete, soils, aggregates, and loose asphalt mixtures. Use manufacturer's recommendations for drying other construction materials.

### Apparatus

- Vacuum device:
  - Attached to a pump capable of evacuating a sealed chamber to a pressure of 1 kPa (6 mm Hg) when at sea level.
  - Capable of controlling the vacuum, airflow, and temperature in order to properly dry the specimen at close to room temperature.
  - With a display that indicates a pressure value, the dry point in the chamber, and number of cycles.
  - With a plate for removing water from the bottom surface of the specimen chamber.
  - With means to trap moisture that is removed from the sample.
- Chamber (attached to the vacuum device): Large enough to hold cylindrical specimens, 150 mm (6 in.) diameter by 180 mm (7 in.) height, or cubical samples, 150 mm (6 in.) length by 150 mm (6 in.) width by 180 mm (7 in.) height.
- Thermometer: meeting the requirements of M 339/ M 339 or infrared thermometer: accurate to  $\pm 5^{\circ}\text{C}$  ( $\pm 9^{\circ}\text{F}$ ) to be used to measure surface temperature of the specimen.

*Note 1:* The thermometer types suitable for use include a handheld infrared thermometer with a D:s ratio of 6:1.

- Balance or scale: Capacity sufficient for the sample mass and conforming to the requirements of M 231, Class G2.

### Daily Equipment Preparation

1. Dry the moisture trap (if necessary) and the specimen (vacuum) chamber.
2. Run the device without any specimens. The device should display a pressure value that indicates a known dry point.

**Note 1:** If the unit fails to achieve a dry point pressure value, as recommended by the manufacturer, check that the lid and all hose connections are well sealed. If needed, refer to the manufacturer's troubleshooting instructions.

## Test Specimens

Test specimens may be either laboratory-molded or sampled from asphalt mixture pavement.

### Procedure

**Note 2:** Keeping the device in the off position when not in use can prolong the operating life of its components.

1. Measure the sample temperature with a handheld infrared thermometer. Make sure the specimen surface temperature is above 15°C (60°F).
2. Remove any standing water from the surface of the specimen by using a paper towel or an absorptive cloth.
3. Place the specimen inside the vacuum chamber, closing the lid to the vacuum chamber and moisture trap (if applicable).
4. Initiate the vacuum drying cycle. The pressure is monitored throughout the drying cycle to ensure dry specimen condition pressure is achieved in the device.
5. The device will automatically stop when the specimen is dry.

**Note 3:** The device is calibrated at the factory or by the operator according to manufacturer's recommended procedures to sense a dry specimen condition.

6. Remove the specimen from the chamber.
7. Determine and record the specimen mass to the nearest 0.1 g.
8. Repeat steps 5 through 7 until specimen weight after vacuum drying cycle is less than 0.3 g from previous drying cycle.

**Note 4:** Between drying cycles, wipe off any free-standing water in the moisture trap to speed up the specimen drying cycles.

**Note 5:** Excessive temperature may damage the specimen. Between drying cycles, verify that the specimen temperature has not exceeded 54°C (130°F).



**PERFORMANCE EXAM CHECKLIST**

**VACUUM DRYING COMPACTED ASPHALT SPECIMENS  
FOP FOR AASHTO R 79**

**Participant Name** \_\_\_\_\_ **Exam Date** \_\_\_\_\_

Record the symbols “P” for passing or “F” for failing on each step of the checklist.

<b>Procedure Element</b>	<b>Trial 1</b>	<b>Trial 2</b>
1. Device moisture trap dry and specimen (vacuum) chamber?	_____	_____
2. Device displays a known dry point after being run without a specimen?	_____	_____
3. Specimen surface temperature above 60°F (15°C)?	_____	_____
4. Specimen surfaced dried and placed inside vacuum chamber?	_____	_____
5. Vacuum drying cycle initiated after closing chamber and moisture trap lids?	_____	_____
6. Specimen removed from chamber and mass determined to the nearest 0.1 g after drying cycle complete?	_____	_____
7. Drying cycle steps repeated until specimen mass is less than 0.3 g from previous drying cycle mass?	_____	_____
8. Free-standing water in moisture trap wiped off between cycles?	_____	_____

**Comments:** First attempt: Pass\_\_\_\_Fail\_\_\_\_\_ Second attempt: Pass\_\_\_\_Fail\_\_\_\_\_

\_\_\_\_\_

\_\_\_\_\_

\_\_\_\_\_

\_\_\_\_\_

\_\_\_\_\_

Examiner Signature \_\_\_\_\_ WAQTC #: \_\_\_\_\_



## SPECIFIC GRAVITY AND ABSORPTION OF COARSE AGGREGATE FOP FOR AASHTO T 85

### Scope

This procedure covers the determination of specific gravity and absorption of coarse aggregate in accordance with AASHTO T 85-22. Specific gravity may be expressed as bulk specific gravity ( $G_{sb}$ ), bulk specific gravity, saturated surface dry ( $G_{sb}$  SSD), or apparent specific gravity ( $G_{sa}$ ).  $G_{sb}$  and absorption are based on aggregate after soaking in water. This procedure is not intended to be used with lightweight aggregates.

### Terminology

Absorption – the increase in the mass of aggregate due to water being absorbed into the pores of the material, but not including water adhering to the outside surface of the particles, expressed as a percentage of the dry mass. The aggregate is considered “dry” when it has been maintained at a temperature of  $110 \pm 5^\circ\text{C}$  ( $230 \pm 9^\circ\text{F}$ ) for sufficient time to remove all uncombined water.

Saturated Surface Dry (SSD) – condition of an aggregate particle when the permeable voids are filled with water, but no water is present on exposed surfaces.

Specific Gravity – the ratio of the mass, in air, of a volume of a material to the mass of the same volume of gas-free distilled water at a stated temperature.

Apparent Specific Gravity ( $G_{sa}$ ) – the ratio of the mass, in air, of a volume of the impermeable portion of aggregate to the mass of an equal volume of gas-free distilled water at a stated temperature.

Bulk Specific Gravity ( $G_{sb}$ ) – the ratio of the mass, in air, of a volume of aggregate (including the permeable and impermeable voids in the particles, but not including the voids between particles) to the mass of an equal volume of gas-free distilled water at a stated temperature.

Bulk Specific Gravity (SSD) ( $G_{sb}$  SSD) – the ratio of the mass, in air, of a volume of aggregate, including the mass of water within the voids filled to the extent achieved by submerging in water for 15 to 19 hours (but not including the voids between particles), to the mass of an equal volume of gas-free distilled water at a stated temperature.

### Apparatus

- Balance or scale: with a capacity of 5 kg, sensitive to 0.1 g. Meeting the requirements of AASHTO M 231.
- Sample container: a wire basket of 3.35 mm (No. 6) or smaller mesh, with a capacity of 4 to 7 L (1 to 2 gal) to contain aggregate with a nominal maximum size of 37.5 mm (1 1/2 in.) or smaller; or a larger basket for larger aggregates, or both.
- Water tank: watertight and large enough to completely immerse aggregate and basket, equipped with an overflow valve to keep water level constant.

- Suspension apparatus: wire used to suspend apparatus shall be of the smallest practical diameter.
- Sieves: 4.75 mm (No. 4) or other sizes as needed, meeting the requirements of FOP for AASHTO T 27/T 11.
- Large absorbent cloth

### Sample Preparation

1. Obtain the sample in accordance with the FOP for AASHTO R 90 (see Note 1).
2. Mix the sample thoroughly and reduce it to the approximate sample size required by Table 1 in accordance with the FOP for AASHTO R 76.
3. Reject all material passing the appropriate sieve by dry sieving.
4. Thoroughly wash sample to remove dust or other coatings from the surface.
5. Dry the sample to constant mass according to the FOP for AASHTO T 255/T 265 at a temperature of  $110 \pm 5^\circ\text{C}$  ( $230 \pm 9^\circ\text{F}$ ) and cool in air at room temperature for 1 to 3 hours.

*Note 1:* Where the absorption and specific gravity values are to be used in proportioning concrete mixtures in which the aggregates will be in their naturally moist condition, the requirement for initial drying to constant mass may be eliminated, and, if the surfaces of the particles in the sample have been kept continuously wet until test, the 15-to-19-hour soaking may also be eliminated.

6. Re-screen the sample over the appropriate sieve. Reject all material passing that sieve.
7. The sample shall meet or exceed the minimum mass given in Table 1.

*Note 2:* If this procedure is used only to determine the  $G_{sb}$  of oversized material for the FOP for AASHTO T 99 / T 180, the material can be rejected over the appropriate sieve. For T 99 / T 180 Methods A and B, use the 4.75 mm (No. 4) sieve; T 99 / T 180 Methods C and D use the 19 mm (3/4 in).

**Table 1**

Nominal Maximum Size* mm (in.)	Minimum Mass of Sample, g (lb)
12.5 (1/2) or less	2000 (4.4)
19.0 (3/4)	3000 (6.6)
25.0 (1)	4000 (8.8)
37.5 (1 1/2)	5000 (11)
50 (2)	8000 (18)
63 (2 1/2)	12,000 (26)
75 (3)	18,000 (40)

\* One sieve larger than the first sieve to retain more than 10 percent of the material using an agency specified set of sieves based on cumulative percent retained. Where large gaps in specification sieves exist, intermediate sieve(s) may be inserted to determine nominal maximum size.

**Procedure**

1. Immerse the sample in water at room temperature for a period of 15 to 19 hours.

*Note 3:* When testing coarse aggregate of large nominal maximum size requiring large samples, it may be more convenient to perform the test on two or more subsamples, and then combine the values obtained.

2. Place the empty basket into the water bath and attach to the balance. Inspect the immersion tank to ensure the water level is at the overflow outlet height and basket is fully submerged. Tare the balance with the empty basket attached in the water bath.
3. Remove the sample from the water and roll it in a large absorbent cloth until all visible films of water are removed. Wipe the larger particles individually. If the sample dries past the SSD condition, immerse in water for 30 min, and then resume the process of surface-drying.

*Note 4:* A moving stream of air may be used to assist in the drying operation but take care to avoid evaporation of water from aggregate pores.

4. Determine the SSD mass of the sample, and record this and all subsequent masses to the nearest 0.1 g or 0.1 percent of the sample mass, whichever is greater. Designate this mass as "B."
5. Immediately place the SSD sample in the sample container and weigh it in water maintained at  $23.0 \pm 1.7^{\circ}\text{C}$  ( $73.4 \pm 3^{\circ}\text{F}$ ). Shake the container to release entrapped air before recording the weight. Re-inspect the immersion tank to ensure the water level is at the overflow outlet height and basket is fully submerged. Designate this submerged weight as "C."

*Note 5:* The container should be immersed to a depth sufficient to cover it and the sample during mass determination. Wire suspending the container should be of the smallest practical size to minimize any possible effects of a variable immersed length.

6. Remove the sample from the basket. Ensure all material has been removed. Place in a container of known mass.
7. Dry the sample to constant mass according to the FOP for AASHTO T 255 / T 265 at  $110 \pm 5^{\circ}\text{C}$  ( $230 \pm 9^{\circ}\text{F}$ ) and cool in air at room temperature for 1 to 3 hours.
8. Determine and record the dry mass. Designate this mass as "A."

**Calculations**

Perform calculations and determine values using the appropriate formula below.

Bulk specific gravity ( $G_{sb}$ )

$$G_{sb} = \frac{A}{B - C}$$

Bulk specific gravity, SSD ( $G_{sb} SSD$ )

$$G_{sb}SSD = \frac{B}{B - C}$$

Apparent specific gravity ( $G_{sa}$ )

$$G_{sa} = \frac{A}{A - C}$$

Absorption

$$\text{Absorption} = \frac{B - A}{A} \times 100$$

Where:

- A = oven dry mass, g
- B = SSD mass, g
- C = weight in water, g

EMBANKMENT AND BASE  
IN-PLACE DENSITY

WAQTC

FOP AASHTO T 85 (22)

### Sample Calculations

Sample	A	B	C	B - C	A - C	B - A
1	2030.9	2044.9	1304.3	740.6	726.6	14.0
2	1820.0	1832.5	1168.1	664.4	651.9	12.5
3	2035.2	2049.4	1303.9	745.5	731.3	14.2

Sample	$G_{sb}$	$G_{sb}$ SSD	$G_{sa}$	Absorption
1	2.742	2.761	2.795	0.7
2	2.739	2.758	2.792	0.7
3	2.730	2.749	2.783	0.7

These calculations demonstrate the relationship between  $G_{sb}$ ,  $G_{sb}$  SSD, and  $G_{sa}$ .  $G_{sb}$  is always lowest since the volume includes voids permeable to water.  $G_{sb}$  SSD is always intermediate.  $G_{sa}$  is always highest since the volume does not include voids permeable to water. When running this test, check to make sure the values calculated make sense in relation to one another.

### Report

- On forms approved by the agency
- Sample ID
- Specific gravity values to the nearest 0.001
- Absorption to the nearest 0.1 percent

EMBANKMENT AND BASE  
IN-PLACE DENSITY

WAQTC

FOP AASHTO T 85 (22)



**PERFORMANCE EXAM CHECKLIST**

**SPECIFIC GRAVITY AND ABSORPTION OF COARSE AGGREGATE  
FOP FOR AASHTO T 85**

Participant Name \_\_\_\_\_ Exam Date \_\_\_\_\_

Record the symbols “P” for passing or “F” for failing on each step of the checklist.

Procedure Element	Trial 1	Trial 2
1. Sample obtained by FOP for AASHTO R 90 and reduced by FOP for AASHTO R 76 or from FOP for AASHTO T 99 / T 180?	_____	_____
2. Screened on the appropriate size sieve?	_____	_____
3. Sample mass appropriate?	_____	_____
4. Particle surfaces clean?	_____	_____
5. Dried to constant mass 110 ±5°C (230 ±9°F) and cooled to room temperature?	_____	_____
6. Re-screen over appropriate sieve?	_____	_____
7. Covered with water for 15 to 19 hours?	_____	_____
8. Wire basket completely submerged in immersion tank and attached to balance?	_____	_____
9. Immersion tank inspected for proper water height?	_____	_____
10. Balance tared with basket in tank and temperature checked 23.0 ±1.7°C (73.4 ±3°F)?	_____	_____
11. Sample removed from water and rolled in cloth to remove visible films of water?	_____	_____
12. Larger particles wiped individually?	_____	_____
13. Evaporation avoided?	_____	_____
14. Sample mass determined to 0.1 g?	_____	_____
15. Sample immediately placed in basket, in immersion tank?	_____	_____
16. Entrapped air removed before weighing by shaking basket while immersed?	_____	_____
17. Immersion tank inspected for proper water height?	_____	_____
18. Immersed sample weight determined to 0.1 g?	_____	_____
19. All the sample removed from basket?	_____	_____
20. Sample dried to constant mass and cooled to room temperature?	_____	_____

**OVER**

EMBANKMENT AND BASE

WAQTC

FOP AASHTO T 85 (18)

**Procedure Element**

**Trial 1 Trial 2**

21. Sample mass determined to 0.1 g?

\_\_\_\_\_

22. Proper formulas used in calculations?

\_\_\_\_\_

Comments: First attempt: Pass\_\_\_\_\_Fail\_\_\_\_\_ Second attempt: Pass\_\_\_\_\_Fail\_\_\_\_\_

---

---

---

---

---

---

Examiner Signature \_\_\_\_\_ WAQTC #: \_\_\_\_\_

## **WSDOT Errata to FOP for AASHTO T 89**

### ***Determining the Liquid Limit of Soils***

WAQTC FOP for AASHTO T 89 has been adopted by WSDOT with the following changes:

**Procedure – Method A (Multi-Point) – *Not recognized by WSDOT, use Method B (Single-Point):***



## DETERMINING THE LIQUID LIMIT OF SOILS FOP FOR AASHTO T 89

### Scope

This procedure covers the determination of the liquid limit of a soil in accordance with AASHTO T 89-22. It is used in conjunction with the FOP for AASHTO T 90, Determining the Plastic Limit and Plasticity Index of Soils. The three values are used for soil classification and other purposes.

### Apparatus

- Dish: preferably unglazed porcelain or similar mixing dish, about 115 mm (4.5 in.) in diameter.
- Spatula: having a blade 75 to 100 mm (3 to 4 in.) long and about 20 mm (3/4 in.) wide.
- Liquid Limit Device: manually or mechanically operated, consisting of a brass cup, carriage, and base plate and conforming to the critical dimensions shown in AASHTO T 89 Figure 1.
- Grooving Tool: used to cut the soil in the liquid limit device cup and conforming to the critical dimensions shown in AASHTO T 89 Figure 1.



- Gauge: either part of the grooving tool or a separate metal bar,  $10.0 \pm 0.2$  mm ( $0.394 \pm 0.008$  in.) thick and approximately 50 mm (2 in.) long.
- Containers: corrosion resistant, suitable for repeated heating and cooling, having close fitting lids to prevent the loss of moisture. One container is needed for each moisture content determination.
- Balance: conforming to AASHTO M 231, class G1, sensitive to 0.01 g with a minimum capacity of 100 g.
- Oven: thermostatically controlled, capable of maintaining temperatures of  $110 \pm 5^\circ\text{C}$  ( $230 \pm 9^\circ\text{F}$ ).
- Graduated cylinders for measuring distilled or demineralized water.

- Sieve: 0.425 mm (No. 40) sieve meeting the requirements of the FOP for AASHTO T 27/T 11.

### Adjustment of Liquid Limit Device

The liquid limit device shall be inspected to determine that the device is in good working order; that the pin connecting the cup is not worn to permit side play; that the screws connecting the cup to the hanger are tight; that the points of contact on the cup and base are not excessively worn; that the lip of the cup is not excessively worn; and that a groove has not been worn in the cup. The grooving tool shall be inspected to determine that the critical dimensions are correct.

*Note 1:* Wear is considered excessive when the point of contact on the cup or base exceeds approximately 13 mm (0.5 in.) in diameter, or when any point on the rim of the cup is worn to approximately 1/2 the original thickness. A slight groove in the center of the cup is not objectionable. If the groove becomes pronounced, the cup shall be replaced. A base that is excessively worn may be refinished as long as it is maintained within the tolerances specified.

Adjust the height of drop of the cup so that the point on the cup that comes in contact with the base rises to a height of  $10.0 \pm 0.2$  mm ( $0.394 \pm 0.008$  in.).

*Note 2:* Check the height of the drop, before each new sample, by turning the crank at two revolutions per second while holding the gauge in position against the cup. If a ringing or clicking sound is heard without the cup rising from the gauge, the adjustment is correct. If no ringing is heard or if the cup rises from gauge, readjust the height of the drop. If the cup rocks on the gauge during this checking operation, the cam follower pivot is excessively worn and should be replaced.

### Sample

Samples must be prepared per the AASHTO R 58 or R 74. Obtain a sample with a mass of about 100 g taken from the portion of the material passing the 0.425 mm (No. 40) sieve.

The mass required depends upon the method chosen. Method A (multi-point method) requires approximately 100 g. Method B (single point method) requires approximately 50 g.

### Procedure – Method A (Multi-Point)

1. Determine mass of empty dry container(s) and lid(s) to the nearest 0.01 g.
2. Place the sample in the dish and thoroughly mix with 15 to 20 mL of distilled or demineralized water by alternately and repeatedly stirring, kneading, and chopping with a spatula. Further additions of water shall be in increments of 1 to 3 mL. Each increment shall be thoroughly mixed with the soil before another increment is added. Once testing has begun, no additional dry soil should be added to the moistened soil. The cup of the Liquid Limit device shall not be used for mixing soil and water. If too much water is added, the sample shall either be discarded or mixed and kneaded until natural evaporation lowers the moisture content.

*Note 3:* Some soils are slow to absorb water. It is possible to add water so fast that a false LL value is obtained. This can be avoided by allowing more mixing and/or time. Also, tap water may be used for routine testing if comparative tests indicate no differences in results between using tap water and distilled or demineralized water.

3. Add sufficient water to form a uniform mass of a stiff consistency.

4. Place enough material in the cup so that, when squeezed and spread with the spatula, the soil will rest in the cup above the spot where the cup rests on the base and will be 10 mm thick at the point of maximum thickness. Use as few strokes of the spatula as possible, taking care to prevent the entrapment of air bubbles in the sample.
5. Divide the soil in the cup with a firm stroke of the grooving tool. Avoid tearing of the sides of the groove or slipping of the soil cake on the cup. Up to six strokes are permitted with a stroke from front to back or from back to front counting as 1 stroke. The depth of the groove should be increased with each stroke, and only the last stroke should scrape the bottom of the cup.
6. Lift and drop the cup by turning the crank at a rate of approximately two revolutions per second until the two halves of the soil pat come together along a distance of about 13 mm (0.5 in.). Do not hold the base while the crank is turned. Record the number of shocks required to close the groove this distance.

*Note 4:* Some soils tend to slide on the cup instead of flowing. If this occurs, water should be added, the sample remixed, and the procedure repeated. If the soil continues to slide on the cup, the test is not applicable, and a note should be made that the liquid limit could not be determined.

7. Use the spatula to obtain a moisture content sample by slicing through the soil pat perpendicularly to the groove. Remove the sample extending edge to edge and including the portion of the groove that flowed together. Place it into a suitable container and cover for subsequent moisture determination.
8. Determine the moisture percentage of the moisture content sample in accordance with the FOP for AASHTO T 255/T 265 (Soil).
9. Place the soil remaining in the cup back in the mixing dish and add 1 to 3 mL of water or use previously prepared portions to which sufficient water has been added to result in a more fluid condition.
10. Repeat Steps 4 through 9, a minimum of two times. The object is to have a determination in all three shock ranges 25-35, 20-30, and 15-25 and span a range of at least 10 shocks.
11. Determine the moisture content of the moisture content sample in accordance with the FOP for AASHTO T 255/T 265 (Soil). (Remove lids and keep with containers while drying.)

### **Flow Curve – Method A**

Prepare a flow curve on a semi-logarithmic graph with moisture content on the arithmetic vertical axis and the number of shocks on the logarithmic horizontal axis. The flow curve is a straight line drawn as closely as possible through three or more plotted points.

### **Liquid Limit – Method A**

Determine the liquid limit. The moisture content at the intersection of the flow curve and the 25 shock line is the liquid limit.

### Procedure – Method B (Single-Point)

1. Determine mass of empty dry container(s) and lid(s) to the nearest 0.01 g.
2. Place the sample in the dish and thoroughly mix with 8 to 10 mL of distilled or demineralized water, and follow the mixing procedure in Method A, Step 1.
3. Follow the procedure in Method A except that the soil pat should be prepared with water to produce a consistency that will close the two halves of the soil pat at least 13 mm (0.5 in.) within 22 to 28 shocks of the cup.

**Note 5:** Groove closures occurring between 15 and 40 blows may be accepted if variations of  $\pm 5$  percent of the true liquid limit are tolerable.

4. Return the soil remaining in the cup to the mixing dish and, without adding any additional water, repeat Step 2. If the closure again occurs within the acceptable range and is within 2 shocks of the first, obtain a moisture content specimen as described in Method A.
5. Determine the moisture content of the moisture content sample in accordance with the FOP for AASHTO T 255/T 265 (Soil).
6. Determine the moisture content of the moisture content sample in accordance with the FOP for AASHTO T 255/T 265 (Soil). (Remove lids and keep with containers while drying.)

### Liquid Limit – Method B

Calculate the liquid limit as follows:

$$LL = (W_N)(N/25)^{0.121}$$

Where:

- LL = liquid limit  
 $w_N$  = moisture content of sample at N blows  
 N = number of blows

Example:

$$w_N = 16.0\% \quad \text{and} \quad N = 23$$

$$LL = 16.0\% \times \left(\frac{23}{25}\right)^{0.121} = 15.8\%, \text{ report } 16\%$$



Or using Table 1 (when number of shocks to closure of gap is 22-28):

$$LL = 16.0\% \times 0.990 = 15.8\%, \text{ report } 16\%$$

**Table 1**

<u>N</u>	<u>(N/25)<sup>0.121</sup></u>
22	0.985
23	0.990
24	0.995
25	1.000
26	1.005
27	1.009
28	1.014

Use Method A for referee testing to settle a dispute.

### Report

- Results on forms approved by the agency.
- LL rounded to the nearest 1 percent.



## PERFORMANCE EXAM CHECKLIST

### DETERMINING THE LIQUID LIMIT OF SOILS FOP FOR AASHTO T 89

Participant Name \_\_\_\_\_ Exam Date \_\_\_\_\_

Record the symbols "P" for passing or "F" for failing on each step of the checklist.

Procedure Element	Trial 1	Trial 2
1. Describe the inspection for wear of the liquid limit device:		
a. Cup to base connection pin does not allow side to side play of cup?	_____	_____
b. Wear at contact between cup and base ½ inch or less?	_____	_____
c. Edge of cup no less than ½ original thickness?	_____	_____
2. Describe how the height of the cup drop is adjusted:		
a. Checked before each use?	_____	_____
b. Turn crank while holding gauge in position under cup?	_____	_____
c. Check for ringing or clicking without rising of cup?	_____	_____
d. Cup does not rock?	_____	_____
3. Describe initial sample preparation:		
a. Material separated on appropriate sieves?	_____	_____
b. Soil sufficiently pulverized for separation of grains?	_____	_____
c. Material passing the No. 40 recombined and mixed?	_____	_____
4. Mass of empty dry container(s) and lid(s) determined to 0.01 g?	_____	_____
<b>Method A</b>		
5. Preparation of the sample for <b>Method A</b> :		
a. Sample mass approximately 100 g. of minus No. 40?	_____	_____
b. Sample mixed in dish with 15 to 20 ml of distilled or demineralized water?	_____	_____
c. Mixed with spatula until stiff consistency?	_____	_____
d. No dry soil added to lower moisture content?	_____	_____
6. Material placed in cup, centered, 10 mm thick?	_____	_____
7. Soil divided by using up to 6 strokes, preventing tearing or slipping of soil pat?	_____	_____

**OVER**

- 8. Cup lifted and dropped at a rate of 2 revolutions per second? \_\_\_\_\_
- 9. Soil pat halves come together over length of 13 mm (0.5 inch)? \_\_\_\_\_
- 10. Moisture sample properly taken and wet mass determined? \_\_\_\_\_
- 11. Moisture content determined by the FOP for AASHTO T 255/T 265 (soils)? \_\_\_\_\_
- 12. Steps repeated to achieve determinations in three shock ranges of 25-35, 20-30, and 15-25? \_\_\_\_\_
- 13. Flow curve plotted with shocks on logarithmic scale and the moisture on arithmetic scale? \_\_\_\_\_
- 14. Liquid Limit correctly calculated and rounded to nearest whole number? \_\_\_\_\_

**Method B**

- 5. Preparation of the sample for **Method B**:
  - a. Sample mass approximately 50 g. of minus No. 40? \_\_\_\_\_
  - b. Sample mixed in dish with 8 to 10 ml of distilled or demineralized water? \_\_\_\_\_
  - c. Mixed with spatula until stiff consistency? \_\_\_\_\_
  - d. No dry soil added to lower moisture content? \_\_\_\_\_
- 6. Material placed in cup, centered, 10 mm thick? \_\_\_\_\_
- 7. Soil divided by using up to 6 strokes with the grooving tool, preventing tearing or slipping of soil pat? \_\_\_\_\_
- 8. Cup lifted and dropped at a rate of 2 revolutions per second? \_\_\_\_\_
- 9. Soil pat halves come together over length of 13 mm (0.5 inch) between in the 23-28 shock range? \_\_\_\_\_
- 10. Second trial performed with soil pat closure within ± 2 shocks of previous trial? \_\_\_\_\_
- 11. Moisture sample properly taken and wet mass determined? \_\_\_\_\_
- 12. Moisture content determined by the FOP for AASHTO T 255/T 265 (soils)? \_\_\_\_\_
- 13. Liquid limit correctly calculated using equation or Table 1 and rounded to nearest whole number? \_\_\_\_\_
- 14. Results reported on standard agency form? \_\_\_\_\_

Comments: First attempt: Pass \_\_\_\_\_ Fail \_\_\_\_\_ Second attempt: Pass \_\_\_\_\_ Fail \_\_\_\_\_

---



---



---



---

Examiner Signature \_\_\_\_\_ WAQTC #: \_\_\_\_\_

# WSDOT Errata to FOP for AASHTO R 90

## Sampling Aggregate Products

WAQTC FOP for AASHTO R 90 has been adopted by WSDOT with the following changes:

### Procedure – General

TABLE 1 Recommended Sample Sizes – *Shall conform to the following table, nominal maximum size definition and note.*

Nominal Maximum Size*in (mm)		Minimum Mass lb (kg)	
US No. 4	(4.75)	5	(2)
¼	(6.3)	10	(4)
⅜	(9.5)	10	(4)
½	(12.5)	20	(8)
⅝	(16.0)	20	(8)
¾	(19.0)	30	(12)
1	(25.0)	55	(25)
1¼	(31.5)	70	(30)
1½	(37.5)	80	(36)
2	(50)	90	(40)
2½	(63)	110	(50)
3	(75)	140	(60)
3½	(90)	180	(80)

\*For Aggregate, the nominal maximum size sieve is the largest standard sieve opening listed in the applicable specification upon which more than 1-percent of the material by weight is permitted to be retained. For concrete aggregate, the nominal maximum size sieve is the smallest standard sieve opening through which the entire amount of aggregate is permitted to pass.

**Note:** For an aggregate specification having a generally unrestrictive gradation (i.e., wide range of permissible upper sizes), where the source consistently fully passes a screen substantially smaller than the maximum specified size, the nominal maximum size, for the purpose of defining sampling and test specimen size requirements may be adjusted to the screen, found by experience to retain no more than 5 percent of the materials.

### Procedure – Specific Situations

#### Roadways

**Method A (Berm or Windrow)** – *Method not recognized by WSDOT.*

**Method B (In-Place)** – *Method not recognized by WSDOT.*



## **SAMPLING AGGREGATE PRODUCTS FOP FOR AASHTO R 90**

### **Scope**

This procedure covers sampling of coarse, fine, or a combination of coarse and fine aggregates (CA and FA) in accordance with AASHTO R 90-18. Sampling from conveyor belts, transport units, roadways, and stockpiles is covered.

### **Apparatus**

- Shovels or scoops, or both
- Brooms, brushes, and scraping tools
- Sampling tubes of acceptable dimensions
- Mechanical sampling systems: normally a permanently attached device that allows a sample container to pass perpendicularly through the entire stream of material or diverts the entire stream of material into the container by manual, hydraulic, or pneumatic operation
- Belt template
- Sampling containers

### **Procedure – General**

Sampling is as important as testing. The technician shall use every precaution to obtain samples that are representative of the material. Determine the time or location for sampling in a random manner.

1. Wherever samples are taken, obtain multiple increments of approximately equal size.
2. Mix the increments thoroughly to form a field sample that meets or exceeds the minimum mass recommended in Table 1.

**TABLE 1**  
**Recommended Sample Sizes**

<b>Nominal Maximum Size*</b>	<b>Minimum Mass</b>
<b>mm (in.)</b>	<b>g (lb)</b>
90 (3 1/2)	175,000 (385)
75 (3)	150,000 (330)
63 (2 1/2)	125,000 (275)
50 (2)	100,000 (220)
37.5 (1 1/2)	75,000 (165)
25.0 (1)	50,000 (110)
19.0 (3/4)	25,000 (55)
12.5 (1/2)	15,000 (35)
9.5 (3/8)	10,000 (25)
4.75 (No. 4)	10,000 (25)
2.36 (No. 8)	10,000 (25)

\* One sieve larger than the first sieve to retain more than 10 percent of the material using an agency specified set of sieves based on cumulative percent retained. Where large gaps in specification sieves exist, intermediate sieve(s) may be inserted to determine nominal maximum size. Maximum size is one size larger than nominal maximum size.

**Note 1:** Sample size is based upon the test(s) required. As a general rule, the field sample size should be such that, when split twice will provide a testing sample of proper size. For example, the sample size may be four times that shown in Table 1 of the FOP for AASHTO T 27/T 11, if that mass is more appropriate.

## Procedure – Specific Situations

### Conveyor Belts

Avoid sampling at the beginning or end of the aggregate run due to the potential for segregation. Be careful when sampling in the rain. Make sure to capture fines that may stick to the belt or that the rain tends to wash away.

#### Method A (From the Belt)

1. Stop the belt.
2. Set the sampling template in place on the belt, avoiding intrusion by adjacent material.
3. Remove the material from inside the template, including all fines.
4. Obtain at least three approximately equal increments.
5. Combine the increments and mix thoroughly to form a single sample.



**Method B (From the Belt Discharge)**

1. Pass a sampling device through the full stream of the material as it runs off the end of the conveyor belt. The sampling device may be manually, semi-automatic or automatically powered.
2. The sampling device shall pass through the stream at least twice, once in each direction, without overfilling while maintaining a constant speed during the sampling process.
3. When emptying the sampling device into the container, include all fines.
4. Combine the increments and mix thoroughly to form a single sample.

**Transport Units**

1. Visually divide the unit into four quadrants.
2. Identify one sampling location in each quadrant.
3. Dig down and remove approximately 0.3 m (1 ft.) of material to avoid surface segregation. Obtain each increment from below this level.
4. Combine the increments and mix thoroughly to form a single sample.

**Roadways****Method A (Berm or Windrow)**

1. Obtain sample before spreading.
2. Take the increments from at least three random locations along the fully formed windrow or berm. Do not take the increments from the beginning or the end of the windrow or berm.
3. Obtain full cross-section samples of approximately equal size at each location. Take care to exclude the underlying material.
4. Combine the increments and mix thoroughly to form a single sample.

*Note 2:* Obtaining samples from berms or windrows may yield extra-large samples and may not be the preferred sampling location.

**Method B (In-Place)**

1. Obtain sample after spreading and before compaction.
2. Take the increments from at least three random locations.
3. Obtain full-depth increments of approximately equal size from each location. Take care to exclude the underlying material.
4. Combine the increments and mix thoroughly to form a single sample.

## Stockpiles

### Method A – Loader Sampling

1. Direct the loader operator to enter the stockpile with the bucket at least 150 mm (6 in.) above ground level without contaminating the stockpile.
2. Discard the first bucketful.
3. Have the loader re-enter the stockpile and obtain a full loader bucket of the material, tilt the bucket back and up.
4. Form a small sampling pile at the base of the stockpile by gently rolling the material out of the bucket with the bucket just high enough to permit free flow of the material. (Repeat as necessary.)
5. Create a flat surface by having the loader back drag the small pile.
6. Visually divide the flat surface into four quadrants.
7. Collect an increment from each quadrant by fully inserting the shovel into the flat pile as vertically as possible, take care to exclude the underlying material, roll back the shovel and lift the material slowly out of the pile to avoid material rolling off the shovel.
8. Combine the increments and mix thoroughly to form a single sample.

### Method B – Stockpile Face Sampling

1. Create horizontal surfaces with vertical faces in the top, middle, and bottom third of the stockpile with a shovel or loader.
2. Prevent continued sloughing by shoving a flat board against the vertical face. Sloughed material will be discarded to create the horizontal surface.
3. Obtain sample from the horizontal surface as close to the intersection as possible of the horizontal and vertical faces.
4. Obtain at least one increment of equal size from each of the top, middle, and bottom thirds of the pile.
5. Combine the increments and mix thoroughly to form a single sample.

### Method C – Alternate Tube Method (Fine Aggregate)

1. Remove the outer layer that may have become segregated.
2. Using a sampling tube, obtain one increment of equal size from a minimum of five random locations on the pile.
3. Combine the increments to and mix thoroughly form a single sample.

**Identification and Shipping**

- Identify samples according to agency standards.
- Include sample report (below).
- Ship samples in containers that will prevent loss, contamination, or damage of material.

**Report**

- On forms approved by the agency
- Date
- Time
- Sample ID
- Sampling method
- Location
- Quantity represented
- Material type
- Supplier

AGGREGATE

WAQTC

FOP AASHTO R 90 (22)

AGGREGATE

WAQTC

FOP AASHTO R 90 (22)

**PERFORMANCE EXAM CHECKLIST****SAMPLING AGGREGATE PRODUCTS  
FOP FOR AASHTO R 90**

Participant Name \_\_\_\_\_ Exam Date \_\_\_\_\_

**Record the symbols “P” for passing or “F” for failing on each step of the checklist.**

<b>Procedure Element</b>	<b>Trial 1</b>	<b>Trial 2</b>
<b>Conveyor Belts – Method A (From the Belt)</b>		
1. Belt stopped?	_____	_____
2. Sampling template set on belt, avoiding intrusion of adjacent material?	_____	_____
3. Sample, including all fines, scooped off?	_____	_____
4. Samples taken in at least three approximately equal increments?	_____	_____
5. Increments combined and mixed to form a single sample?	_____	_____
<b>Conveyor Belts – Method B (From the Belt Discharge)</b>		
6. Sampling device passed through full stream of material twice (once in each direction) as it runs off end of belt?	_____	_____
7. Increments combined and mixed to form a single sample?	_____	_____
<b>Transport Units</b>		
8. Unit divided into four quadrants?	_____	_____
9. Increment obtained from each quadrant, 0.3 m (1ft.) below surface?	_____	_____
10. Increments combined and mixed to form a single sample?	_____	_____
<b>Roadways Method A (Berm or Windrow)</b>		
11. Sample taken before spreading?	_____	_____
12. Full depth of material taken?	_____	_____
13. Underlying material excluded?	_____	_____
14. Samples taken in at least three approximately equal increments?	_____	_____
15. Increments combined and mixed to form a single sample?	_____	_____
<b>Roadways Method B (In-place)</b>		
16. Sample taken after spreading?	_____	_____
17. Full depth of material taken?	_____	_____

**OVER**

17\_R90\_pr\_22

Aggregate 3-11

Pub. October 2024 (v. 2025)

AGGREGATE

WAQTC

FOP AASHTO R 90 (22)

- 18. Underlying material excluded? \_\_\_\_\_
- 19. Samples taken in at least three approximately equal increments? \_\_\_\_\_
- 20. Increments combined and mixed to form a single sample? \_\_\_\_\_

**Stockpile Method A– (Loader sampling)**

- 21. Loader operator directed to enter the stockpile with the bucket at least 150 mm (6 in.) above ground level without contaminating the stockpile? \_\_\_\_\_
- 22. First bucketful discarded? \_\_\_\_\_
- 23. The loader re-entered the stockpile and obtained a full loader bucket of the material with the bucket tilted back and up? \_\_\_\_\_
- 24. A small sampling pile formed at the base of the stockpile by gently rolling the material out of the bucket with the bucket just high enough to permit free-flow of the material? \_\_\_\_\_
- 25. A flat surface created by the loader back dragging the small pile? \_\_\_\_\_
- 26. Increment sampled from each quadrant by fully inserting the shovel into the flat pile as vertically as possible, care taken to exclude the underlying material? \_\_\_\_\_
- 27. Increments combined and mixed to form a single sample? \_\_\_\_\_

**Stockpile Method B (Stockpile Face)**

- 28. Created horizontal surfaces with vertical faces? \_\_\_\_\_
- 29. At least one increment taken from each of the top, middle, and bottom thirds of the stockpile. \_\_\_\_\_
- 30. Increments combined and mixed to form a single sample? \_\_\_\_\_

**Stockpile Method C – Alternate Tube Method (Fine Aggregate)**

- 31. Outer layer removed? \_\_\_\_\_
- 32. Increments taken from at least five locations with a sampling tube? \_\_\_\_\_
- 33. Increments combined and mixed to form a single sample? \_\_\_\_\_

Comments: First attempt: Pass\_\_\_\_ Fail\_\_\_\_ Second attempt: Pass\_\_\_\_ Fail \_\_\_\_

\_\_\_\_\_

\_\_\_\_\_

\_\_\_\_\_

Examiner Signature \_\_\_\_\_ WAQTC #: \_\_\_\_\_

**PERFORMANCE EXAM CHECKLIST (ORAL)**

**SAMPLING AGGREGATE PRODUCTS  
FOP FOR AASHTO R 90**

Participant Name \_\_\_\_\_ Exam Date \_\_\_\_\_

Record the symbols "P" for passing or "F" for failing on each step of the checklist.

<b>Procedure Element</b>	<b>Trial 1</b>	<b>Trial 2</b>
<b>1. How is a sample obtained from a conveyor belt using Method A?</b>		
a. Stop the belt.	_____	_____
b. Set the sampling template on belt, avoiding intrusion of adjacent material.	_____	_____
c. All the material is removed from belt including all fines.	_____	_____
d. Take at least three approximately equal increments.	_____	_____
e. Combine and mix to form a single sample.	_____	_____
<b>2. How is a sample obtained from a conveyor belt using Method B?</b>		
a. Pass the sampling device through a full stream of material as it runs off the end of the belt.	_____	_____
b. The device must be passed through at least twice (once in each direction).	_____	_____
c. Increments combined and mixed to form a single sample?	_____	_____
d. Combine and mix to form a single sample.	_____	_____
<b>3. How is a sample obtained from a Transport Unit?</b>		
a. Divide the unit into four quadrants.	_____	_____
b. Dig 0.3 m (1 ft.) below surface.	_____	_____
c. Obtain an increment from each quadrant.	_____	_____
d. Combine and mix to form a single sample.	_____	_____
<b>4. Describe the procedure for sampling from roadways Method A (Berm or Windrow).</b>		
a. Sample before spreading	_____	_____
b. Sample the material full depth without obtaining underlying material.	_____	_____
c. Take at least three approximately equal increments.	_____	_____
d. Combine and mix to form a single sample.	_____	_____

**OVER**

**Procedure Element**

**Trial 1    Trial 2**

**5. Describe the procedure for sampling from roadway Method B (In-place).**

- a. Sample after spreading, before compaction. \_\_\_\_\_
- b. Sample the material full depth without obtaining underlying material. \_\_\_\_\_
- c. Take at least three approximately equal increments. \_\_\_\_\_
- d. Combine and mix to form a single sample. \_\_\_\_\_

**6. Describe the procedure for sampling a stockpile Method A (Loader Sampling).**

- a. Loader enters the stockpile at least 150 mm (6in.) above ground level. \_\_\_\_\_
- b. Loader discard first bucket full. \_\_\_\_\_
- c. Loader obtains a full bucket of material and forms a small sampling pile. \_\_\_\_\_
- d. Loader back drags pile to create a flat surface. \_\_\_\_\_
- e. Divide the flat surface into four quadrants. \_\_\_\_\_
- f. Take an approximately equal increment from each quadrant, excluding the underlying material. \_\_\_\_\_
- g. Combine and mix to form a single sample. \_\_\_\_\_

**7. Describe the procedure for sampling a stockpile Method B (Stockpile Face Sampling).**

- a. Create horizontal surfaces with vertical faces with a shovel. \_\_\_\_\_
- b. At least one increment taken from each of the top, middle, and bottom thirds of the stockpile. \_\_\_\_\_
- c. Combine and mix to form a single sample. \_\_\_\_\_

**8. Describe the procedure for sampling a stockpile Method C – Alternate Tube Method (Fine Aggregate).**

- a. Remove the outer layer of segregated material. \_\_\_\_\_
- b. Obtain increments using sampling tube from at least five locations. \_\_\_\_\_
- c. Combine and mix to form a single sample. \_\_\_\_\_

Comments:    First attempt:    Pass \_\_\_\_\_ Fail \_\_\_\_\_    Second attempt:    Pass \_\_\_\_\_ Fail \_\_\_\_\_

\_\_\_\_\_  
\_\_\_\_\_  
\_\_\_\_\_

Examiner Signature \_\_\_\_\_ WAQTC #: \_\_\_\_\_



# WSDOT Errata to FOP for AASHTO R 97

## ***Sampling Asphalt Mixtures***

WAQTC FOP for AASHTO R 97 has been adopted by WSDOT with the following changes:

### **Sample Size**

For Acceptance sampling and testing only: WSDOT requires a minimum of two times the amount required for testing. This should be approximately 60 lbs.

For Acceptance and Conformation sampling and testing or for Test Section sampling and testing: WSDOT requires a minimum of four times the amount required for testing. This should be approximately 120 lbs. (See WSDOT *Construction Manual* [Section 9-3.7](#) for Conformation sampling frequency)

**Note:** When sampling or testing for Determination of the Moving Average of Theoretical Maximum Density (TMD) for Asphalt Mixtures, please refer to WSDOT SOP 729.

### **Procedure**

#### **General**

*Include the steps below:*

- Immediately upon obtaining a sample, using a verified thermometer, check and record temperature of the sample.
- The material shall be tested to determine variations. The supplier/contractor shall obtain a representative sample the asphalt mixture in the presence of the Project Engineer. The supplier/contractor shall provide a safe environment for sampling:

**Attached Sampling Device** - Manual device not recognized by WSDOT

**Attached Sampling Device** - *add the following* A mechanical sampling device installed between the discharge of the silo and the truck transport that is approved by the Regional Materials Engineer.

**Transport Units** - *add the following* Platforms or devices to enable sampling from the truck transport without entering the truck transport for sampling Asphalt Mixtures.

**Conveyor Belts** - *Method not recognized by WSDOT.*

**Paver Auger** - *Method not recognized by WSDOT.*

**Windrow** - *Method not recognized by WSDOT.*

### **Roadway before Compaction**

**Method 1 - Obtaining a Sample on Grade or Untreated Base (Plate Method)** - *Method not recognized by WSDOT.*

**Method 2 - Obtaining a Sample on Asphalt Surface (Non-Plate Method)** - *Method not recognized by WSDOT.*

## Stockpiles

Method 1 – Loader - *Method not recognized by WSDOT.*

Method 2 – Stockpile Face - *Method not recognized by WSDOT.*

## SAMPLING ASPHALT MIXTURES FOP FOR AASHTO R 97

### Scope

This procedure covers sampling asphalt mixtures from plants, transport units, and roadways in accordance with AASHTO R 97-19. Sampling is as important as testing. Use care to obtain a representative sample. Avoid segregation and contamination of the material during sampling.

*This standard does not purport to address all of the safety concerns, if any, associated with its use. It is the responsibility of the user of this standard to establish appropriate safety and health practices and determine the applicability of regulatory limitations prior to use.*

### Apparatus

- Shovel or Metal Scoops, or Other Equipment: square-head metal shovels at least 125 mm (5.5 in.) wide.
- Sample containers: such as cardboard boxes, metal cans, stainless steel bowls, or other agency-approved containers
- Sampling plate: thick metal plate, minimum 8 gauge, sized to accommodate sample requirements, with a wire attached to one corner long enough to reach from the center of the paver to the outside of the farthest auger extension. A minimum of one hole 6 mm (0.25 in.) in diameter must be provided in a corner of the plate.
- Cookie cutter sampling device: formed steel angle with two 100 mm by 150 mm by 9 mm (4 in. by 6 in. by 3/8 in.) handles, sized to accommodate sample requirements. Minimum 50 mm (2 in.) smaller than the sampling plate when used together.  
*Example:* Sampling plate 380 mm (15 in.) square and a cookie cutter sampling device 330 mm (13 in.) square.
- Mechanical sampling device: a permanently attached device that allows a sample receptacle to pass perpendicularly through the entire stream of material or diverts the entire stream of material into the container by manual, hydraulic, or pneumatic operation.
- Agency approved release agent: a non-stick product that prevents the asphalt mixture from sticking to the apparatus and does not contain solvents or petroleum-based products that could affect asphalt binder properties.

### Sample Size

Sample size depends on the test methods specified by the agency for acceptance. Check agency requirement for the size required.

## Procedure

### General

- Select sample locations using a random or stratified random sampling procedure, as specified by the agency. The material shall be tested to determine variations. The supplier/contractor shall provide equipment for safe and appropriate sampling, including sampling devices on plants when required.
- Ensure the container(s) and sampling equipment are clean and dry before sampling.
- For dense graded mixture samples use cardboard boxes, stainless steel bowls or other agency-approved containers.
- For hot open graded mixture samples use stainless steel bowls. Cardboard boxes can be used if the sample has cooled to the point that asphalt binder will not migrate from the aggregate.

### Attached Sampling Devices

These are normally permanently attached devices that allow a sample container to pass perpendicularly through the entire stream of material. Operation may be manual, pneumatic, or hydraulic and allow the sample container to pass through the stream twice without overfilling. A sampling device may also divert the entire stream into container.

1. Lightly coat the container attached to the sampling device with an agency-approved release agent or preheat it, or both, to approximately the same discharge temperature of the mix.
2. Pass the container twice, once in each direction, through the material perpendicularly without overfilling the container.
3. Transfer the asphalt mixture to an agency-approved container without loss of material.
4. Repeat until proper sample size has been obtained.
5. Combine the increments to form a single sample.

### Conveyor Belts

1. Avoid sampling at the beginning or end of an asphalt mixture production run due to the potential for segregation.
2. Stop the belt containing asphalt mixture.
3. Set the sampling template into the asphalt mixture on the belt, avoiding intrusion by adjacent material.
4. Remove the asphalt mixture from inside the template, including all fines, and place in a sample container.
5. Repeat, obtaining equal size increments, until proper sample size has been obtained.
6. Combine the increments to form a single sample.

### Transport Units

1. Visually divide the transport unit into approximately four equal quadrants.
2. Identify one sampling location in each quadrant.
3. Dig down and remove approximately 0.3 m (1 ft.) of material to avoid surface segregation. Obtain each increment from below this level.
4. Combine the increments to form a sample of the required size.

### Paver Auger

1. Obtain samples from the end of the auger using a square head shovel.
2. Place the shovel in front of the auger extension, with the shovel blade flat upon the surface to be paved over.
3. Allow the front face of the auger stream to cover the shovel with asphalt mixture, remove the shovel before the auger reaches it by lifting as vertically as possible.
4. Place asphalt mixture in a sample container.
5. Repeat until proper sample size has been obtained.
6. Combine the increments to form a sample of the required size.

*Note 1:* First full shovel of material may be discarded to preheat and 'butter' the shovel.

### Windrow

1. Obtain samples from the windrow of a transport unit. Avoid the beginning or the end of the windrow section.
2. Visually divide the windrow into three approximately equal sections.
3. Remove approximately 0.3 m (1 ft) from the top of each section.
4. Fully insert the shovel into the flat surface as vertically as possible, exclude the underlying material, roll back the shovel and lift the material slowly out of the windrow to avoid material rolling off the shovel.
5. Place in a sample container.
6. Repeat, obtaining equal size increments, in each of the remaining thirds.
7. Combine the increments to form a sample of the required size.

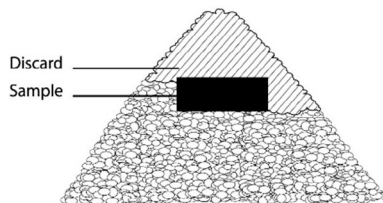

Windrow cross section

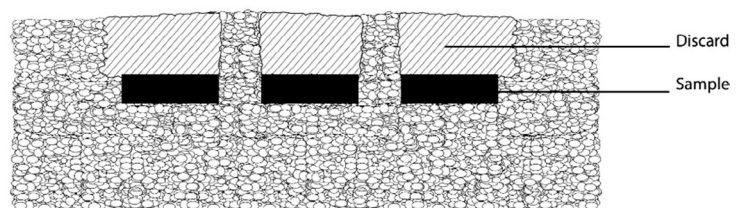

Windrow side view

### Roadway before Compaction

There are two conditions that will be encountered when sampling asphalt mixtures from the roadway before compaction. The two conditions are:

- Laying asphalt mixture on grade or untreated base material requiring Method 1.
- Laying asphalt mixture on existing asphalt or laying a second lift of asphalt mixture allowing Method 2.

### SAFETY:

Sampling is performed behind the paving machine, in front of the breakdown roller. For safety, the breakdown roller must remain at least 3 m (10 ft.) behind the sampling operation until the sample has been obtained and the hole filled with loose asphalt mixture.

Method 1 requires a plate to be placed in the roadway in front of the paving operation. There is always concern with moving, operating equipment. It is safest to stop the paving train while a plate is installed in front of the paver. When this is not possible the following safety rules must be followed.

1. The plate placing operation must be at least 3 m (10 ft.) in front of the paver or pickup device. The technician placing the plate must have eye contact and communication with the paving machine operator. If eye contact cannot be maintained at all times, a third person must be present to provide communication between the operator and the technician.
2. No technician is to be between the asphalt supply trucks and the paving machine. The exception to this rule is if the supply truck is moving forward creating a windrow, in which case the technician must be at least 3 m (10 ft.) behind the truck.

If at any time the Engineer feels that the sampling technique is creating an unsafe condition, the operation is to be halted until it is made safe, or the paving operation will be stopped while the plate is being placed.

### Method 1 - Obtaining a Sample on Grade or Untreated Base (Plate Method)

1. Following the safety rules detailed above, the technician is to:
  - a. Smooth out a location in front of the paver at least 0.5 m (2 ft.) inside the edge of the mat.
  - b. Lay the plate down diagonally with the direction of travel, keeping it flat and tight to the base with the lead corner facing the paving machine.

*Note 2:* The plate may be secured by driving a nail through the hole in the lead corner of the plate.

2. Pull the wire, attached to the outside corner of the plate, taut past the edge of the asphalt mixture mat and secure it. Let the paving operation pass over the plate and wire.
3. Using the exposed end of the wire, pull the wire up through the fresh asphalt mixture to locate the corner of the plate.

- a. Plate only:
  - i. Using a small square head shovel, scoop, or both, remove the full depth of the asphalt mixture from the plate. Take care to prevent sloughing of adjacent material.
  - ii. Place asphalt mixture, including any material adhering to the plate and scoop or shovel in a sample container.
  - iii. Remove the plate from the roadway. The hole made from the sampling must be filled by the contractor with loose asphalt mixture.
- b. "Cookie Cutter":
  - i. Place the "cookie cutter" sample device, just inside the end of the wire; align the cutter over the plate. Press "cookie cutter" device down through the asphalt mixture to the plate.
  - ii. Using a small square tipped shovel or scoop, or both, carefully remove all the asphalt mixture from inside of the cutter and place in a sample container.
  - iii. Remove the sample cutter and the plate from the roadway. The hole made from the sampling must be filled by the contractor with loose asphalt mixture.

### **Method 2 - Obtaining a Sample on Asphalt Surface (Non-plate Method)**

1. After the paving machine has passed the sampling point, immediately place the "cookie cutter" sampling device on the location to be sampled.
2. Push the cutter down through the asphalt mixture until it is flat against the underlying asphalt mat.
3. Using a small square tipped shovel, scoop, or both, carefully remove all the asphalt mixture from inside of the cutter and place in a sample container.
4. Remove the cutter from the roadway. The hole made from the sampling must be filled by the contractor with loose asphalt mixture.

### **Stockpiles**

Remove at least 0.1 m (4 in.) from the surface before sampling; mixtures in a stockpile may develop an oxidized crust.

#### **Method 1 – Loader**

1. Direct the loader operator to enter the stockpile with the bucket at least 0.3 m (1 ft) above ground level without contaminating the stockpile.
2. Obtain a full loader bucket of the asphalt mixture; tilt the bucket back and up.
3. Form a small sampling pile at the base of the stockpile by gently rolling the asphalt mixture out of the bucket with the bucket just high enough to permit free flow of the mixture. Repeat as necessary.
4. Create a flat surface by having the loader "back-drag" the small pile.

5. Obtain approximately equal increments from at least three randomly selected locations on the flat surface at least 0.3 m (1 ft) from the edge.
6. Fully insert the shovel, exclude the underlying material, roll back the shovel and lift the asphalt mixture slowly out of the pile to avoid mixture rolling off the shovel.
7. Combine the increments to form a sample.

### Method 2 – Stockpile Face

1. Create horizontal surfaces with vertical faces in the top, middle, and bottom third of the stockpile with a shovel or a loader if one is available.
2. Shove a flat board against the vertical face behind the sampling location to prevent sloughing of asphalt mixture. Discard the sloughed mixture to create the horizontal surface.
3. Obtain the sample from the horizontal surface as close as possible to the intersection of the horizontal and vertical faces.
4. Obtain at least one sample increment of equal size from each of the top, middle, and bottom thirds of the pile.
5. Combine the increments to form a single sample.

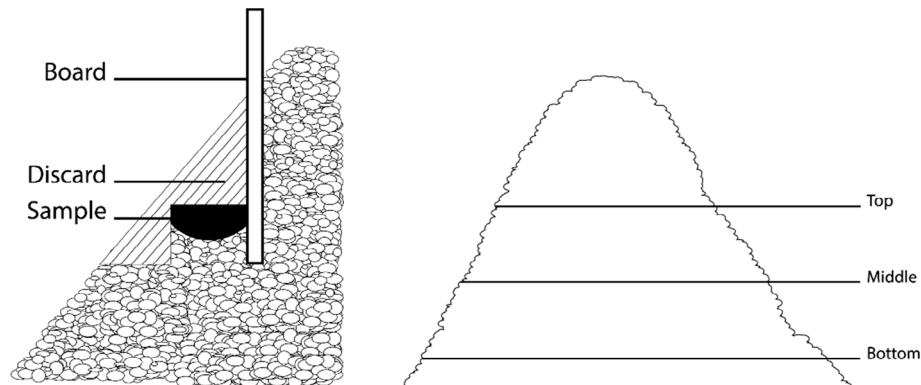

### Identification and Shipping

1. Identify sample containers as required by the agency.
2. Ship samples in containers that will prevent loss, contamination, or damage.



ASPHALT

WAQTC

FOP AASHTO R 97 (23)

**Report**

- On forms approved by the agency
- Sample ID
- Date
- Time
- Location
- Quantity represented

ASPHALT

WAQTC

FOP AASHTO R 97 (23)

**PERFORMANCE EXAM CHECKLIST**

**SAMPLING ASPHALT MIXTURES  
FOP FOR AASHTO R 97**

Participant Name \_\_\_\_\_ Exam Date \_\_\_\_\_

**Record the symbols “P” for passing or “F” for failing on each step of the checklist.**

<b>Procedure Element</b>	<b>Trial 1</b>	<b>Trial 2</b>
<b>Attached Sampling Device</b>		
1. Container coated or preheated or both?	_____	_____
2. Sampling device passed through stream twice perpendicular to material?	_____	_____
3. Sampling device not over filled?	_____	_____
<b>Conveyor Belt</b>		
4. Belt stopped?	_____	_____
5. Sampling template set on belt, avoiding intrusion of adjacent material?	_____	_____
6. Sample, including all fines, scooped off?	_____	_____
<b>Transport Units</b>		
7. Unit divided into four quadrants?	_____	_____
8. Increment obtained from each quadrant, 0.3 m (1ft.) below surface?	_____	_____
9. Increments combined to make up the sample?	_____	_____
<b>Paver Auger</b>		
10. Shovel blade flat on the surface to be paved?	_____	_____
11. Shovel lifted vertically after it is filled?	_____	_____
<b>Windrow</b>		
12. Beginning and end avoided?	_____	_____
13. Equal increments obtained from three sections?	_____	_____
14. Approximately 0.3 m (1 ft) removed from top of each section?	_____	_____
15. Underlying material excluded?	_____	_____
<b>Roadway Before Compaction (Method 1)</b>		
16. Plate placed well in front of paver?	_____	_____
17. Wire pulled to locate plate corner?	_____	_____

**OVER**

ASPHALT

WAQTC

FOP AASHTO R 97 (19)

**Procedure Element** **Trial 1** **Trial 2**

18. Cookie cutter (if used) placed on asphalt and pushed through to plate? \_\_\_\_\_ \_\_\_\_\_

19. All material removed from inside the cutter? \_\_\_\_\_ \_\_\_\_\_

**Roadway Before Compaction (Method 2)**

20. Cookie cutter placed on asphalt and pushed through to underlying material? \_\_\_\_\_ \_\_\_\_\_

21. All material removed from inside the cutter? \_\_\_\_\_ \_\_\_\_\_

**Stockpile Method 1– (Loader sampling)**

22. Loader operator directed to enter the stockpile with the bucket at least 0.3 m (1 ft) above ground level without contaminating the stockpile? \_\_\_\_\_ \_\_\_\_\_

23. The loader obtained a full loader bucket of the material with the bucket tilted back and up? \_\_\_\_\_ \_\_\_\_\_

24. A small sampling pile formed at the base of the stockpile by gently rolling the material out of the bucket with the bucket just high enough to permit free-flow of the material? \_\_\_\_\_ \_\_\_\_\_

25. A flat surface created by the loader back dragging the small pile? \_\_\_\_\_ \_\_\_\_\_

26. Increment sampled from three locations at least 0.3 m (1 ft) from the edge by fully inserting the shovel into the flat pile as vertically as possible, care taken to exclude the underlying material? \_\_\_\_\_ \_\_\_\_\_

**Stockpile Method 2 (Stockpile Face)**

27. Created horizontal surfaces with vertical faces? \_\_\_\_\_ \_\_\_\_\_

28. Sample obtained from the horizontal face as close as possible to the vertical face? \_\_\_\_\_ \_\_\_\_\_

29. At least one increment taken from each of the top, middle, and bottom thirds of the stockpile? \_\_\_\_\_ \_\_\_\_\_

**General**

30. Sample placed in appropriate container? \_\_\_\_\_ \_\_\_\_\_

31. Sample size meets agency requirements? \_\_\_\_\_ \_\_\_\_\_

32. Sample identified as required? \_\_\_\_\_ \_\_\_\_\_

Comments: First attempt: Pass\_\_\_\_\_Fail\_\_\_\_\_ Second attempt: Pass\_\_\_\_\_Fail\_\_\_\_\_

\_\_\_\_\_

\_\_\_\_\_

\_\_\_\_\_

Examiner Signature \_\_\_\_\_

WAQTC #: \_\_\_\_\_

**PERFORMANCE EXAM CHECKLIST (ORAL)**

**SAMPLING ASPHALT MIXTURES  
FOP FOR AASHTO R 97**

Participant Name \_\_\_\_\_ Exam Date \_\_\_\_\_

Record the symbols "P" for passing or "F" for failing on each step of the checklist.

<b>Procedure Element</b>	<b>Trial 1</b>	<b>Trial 2</b>
<b>1. At the hot plant, how must a sample be obtained using an attached sampling device?</b>		
a. Coat or preheat sample container.	_____	_____
b. Sampling device passed through stream twice, once in each direction, perpendicular to material.	_____	_____
c. The sampling device cannot be overfilled.	_____	_____
<b>2. How is a sample obtained from a conveyor belt?</b>		
a. Stop the belt.	_____	_____
b. Set the sampling template on belt, avoiding intrusion of adjacent material.	_____	_____
c. All the material is removed from belt including all fines.	_____	_____
<b>3. What must be done to sample from transport units?</b>		
a. Divide the unit into four quadrants.	_____	_____
b. Obtain increments from each quadrant, 0.3 m (1 ft) below surface.	_____	_____
<b>4. How is a sample obtained from the paver auger?</b>		
a. Shovel blade is placed flat on the surface to be paved in front of the auger extension.	_____	_____
b. Shovel is filled and removed by lifting as vertically as possible.	_____	_____
<b>5. Describe the procedure for sampling from a windrow.</b>		
a. Do not sample from the beginning or end of the windrow.	_____	_____
b. Approximately 0.3 m (1 ft) removed from the top.	_____	_____
c. Underlying material is excluded	_____	_____
d. Equal increments obtained from 3 locations along the windrow.	_____	_____

**OVER**

**Procedure Element**

**Trial 1    Trial 2**

**6. Describe how to take samples from the roadway using Method 1 (plate).**

- a. Place the plate well in front of the paver. \_\_\_\_\_
- b. Pull the wire to locate the corner of the plate. \_\_\_\_\_
- c. Place the cutter (if used) on the asphalt material above the plate and push it down to the plate. \_\_\_\_\_
- d. Collect all the material inside the cutter. \_\_\_\_\_

**7. Describe how to take samples from the roadway using Method 2.**

- a. Place the cutter on the asphalt material and push it down to the underlying material. \_\_\_\_\_
- b. Collect all the material inside the cutter. \_\_\_\_\_

**8. Describe the procedure for sampling a stockpile Method 1 (Loader Sampling).**

- a. Loader removes surface and creates sampling pile. \_\_\_\_\_
- b. Loader back drags pile to create a flat surface. \_\_\_\_\_
- c. Take three approximately equal increments from at least 0.3 m (1 ft) from the edge, excluding the underlying material. \_\_\_\_\_

**9. Describe the procedure for sampling a stockpile Method 2 (Stockpile Face Sampling).**

- a. Create horizontal surfaces with vertical faces with a shovel. \_\_\_\_\_
- b. At least one increment taken from each of the top, middle, and bottom thirds of the stockpile. \_\_\_\_\_

**10. Increments combined to form a sample of required size?**

\_\_\_\_\_

**11. What types of containers can be used?**

- a. Cardboard boxes, stainless steel bowls, or other agency approved containers. \_\_\_\_\_

**12. What dictates size of sample?**

- a. Agency requirements. \_\_\_\_\_
- b. Specified by test method. \_\_\_\_\_

Comments:      First attempt:    Pass\_\_\_\_\_Fail\_\_\_\_\_      Second attempt:    Pass\_\_\_\_\_Fail\_\_\_\_\_

\_\_\_\_\_

\_\_\_\_\_

\_\_\_\_\_

\_\_\_\_\_

Examiner Signature \_\_\_\_\_

WAQTC #: \_\_\_\_\_

# WSDOT Errata to FOP for AASHTO T 99

## *Moisture-Density Relations of Soils*

### *Using a 2.5 KG (5.5 LB) Rammer and a 305 MM (12 IN.) Drop*

WAQTC FOP for AASHTO T 99 has been adopted by WSDOT with the following changes:

#### **Scope**

*Replace with below:*

This procedure covers the determination of the moisture-density relations of soils and soil-aggregate mixtures in accordance with two similar test methods:

AASHTO T 99-22: Methods A, B, C, and D

AASHTO T 180-22: Methods A, B, C, and D

This test method applies to soil mixtures having **30** percent or less retained on the 4.75 mm (No. 4) sieve for methods A or B, or, 30 percent or less retained on the 19 mm ( $\frac{3}{4}$  in) with methods C or D. The retained material is defined as oversize (coarse) material. If no minimum percentage is specified, 5 percent will be used. Samples that contain oversize (coarse) material that meet percent retained criteria should be corrected by using *Annex A, Correction of Maximum Dry Density and Optimum Moisture for Oversized Particles*. Samples of soil or soil-aggregate mixture are prepared at several moisture contents and compacted into molds of specified size, using manual or mechanical rammers that deliver a specified quantity of compactive energy. The moist masses of the compacted samples are multiplied by the appropriate factor to determine wet density values. Moisture contents of the compacted samples are determined and used to obtain the dry density values of the same samples. Maximum dry density and optimum moisture content for the soil or soil-aggregate mixture is determined by plotting the relationship between dry density and moisture content.





**MOISTURE-DENSITY RELATIONS OF SOILS:  
USING A 2.5 KG (5.5 LB) RAMMER AND A 305 MM (12 IN.) DROP**

**FOP FOR AASHTO T 99  
USING A 4.54 KG (10 LB) RAMMER AND A 457 MM (18 IN.) DROP  
FOP FOR AASHTO T 180**

### Scope

This procedure covers the determination of the moisture-density relations of soils and soil-aggregate mixtures in accordance with two similar test methods:

- AASHTO T 99-22: Methods A, B, C, and D
- AASHTO T 180-22: Methods A, B, C, and D

This test method applies to soil mixtures having 40 percent or less retained on the 4.75 mm (No. 4) sieve for methods A or B, or 30 percent or less retained on the 19 mm ( $\frac{3}{4}$  in.) sieve with methods C or D. The retained material is defined as oversize (coarse) material. If no minimum percentage is specified, 5 percent will be used. Samples that contain oversize (coarse) material that meet percent retained criteria should be corrected by using *Annex A, Correction of Maximum Dry Density and Optimum Moisture for Oversized Particles*. Samples of soil or soil-aggregate mixture are prepared at several moisture contents and compacted into molds of specified size, using manual or mechanical rammers that deliver a specified quantity of compactive energy. The moist masses of the compacted samples are multiplied by the appropriate factor to determine wet density values. Moisture contents of the compacted samples are determined and used to obtain the dry density values of the same samples. Maximum dry density and optimum moisture content for the soil or soil-aggregate mixture is determined by plotting the relationship between dry density and moisture content.

### Apparatus

- Mold – Cylindrical mold made of metal with the dimensions shown in Table 1 or Table 2. If permitted by the agency, the mold may be of the “split” type, consisting of two half-round sections, which can be securely locked in place to form a cylinder. Determine the mold volume according to *Annex B, Standardization of the Mold*.
- Mold assembly – Mold, base plate, and a detachable collar.
- Rammer – Manually or mechanically operated rammers as detailed in Table 1 or Table 2. A manually operated rammer shall be equipped with a guide sleeve to control the path and height of drop. The guide sleeve shall have at least four vent holes no smaller than 9.5 mm ( $\frac{3}{8}$  in.) in diameter, spaced approximately 90 degrees apart and approximately 19 mm ( $\frac{3}{4}$  in.) from each end. A mechanically operated rammer will uniformly distribute blows over the sample and will be calibrated with several soil types, and be adjusted, if necessary, to give the same moisture-density results as with the manually operated rammer. For additional information concerning calibration, see AASHTO T 99 and T 180.
- Sample extruder – A jack, lever frame, or other device for extruding compacted specimens from the mold quickly and with little disturbance.

- Balance(s) or scale(s) of the capacity and sensitivity required for the procedure used by the agency.
  - A balance or scale with a capacity of 11.5 kg (25 lb) and a sensitivity of 1 g for obtaining the sample, meeting the requirements of AASHTO M 231, Class G 5.
  - A balance or scale with a capacity of 2 kg and a sensitivity of 0.1 g is used for moisture content determinations done under both procedures, meeting the requirements of AASHTO M 231, Class G 2.
- Drying apparatus – A thermostatically controlled drying oven, capable of maintaining a temperature of  $110 \pm 5^{\circ}\text{C}$  ( $230 \pm 9^{\circ}\text{F}$ ) for drying moisture content samples in accordance with the FOP for AASHTO T 255/T 265.
- Straightedge – A steel straightedge at least 250 mm (10 in.) long, with one beveled edge and at least one surface plane within 0.1 percent of its length, used for final trimming.
- Sieve(s) – 4.75 mm (No. 4) and/or 19.0 mm (3/4 in.), meeting the requirements of FOP for AASHTO T 27/T 11.
- Mixing tools – Miscellaneous tools such as a mixing pan, spoon, trowel, spatula, etc., or a suitable mechanical device, for mixing the sample with water.
- Containers with close-fitting lids to prevent gain or loss of moisture in the sample.

EMBANKMENT AND BASE  
IN-PLACE DENSITY

## WAQTC

## FOP AASHTO T 99/T 180 (22)

**Table 1**  
**Comparison of Apparatus, Sample, and Procedure – Metric**

	T 99	T 180
Mold Volume, m <sup>3</sup>	Methods A, C: 0.000943 ±0.000014	Methods A, C: 0.000943 ±0.000014
	Methods B, D: 0.002124 ±0.000025	Methods B, D: 0.002124 ±0.000025
Mold Diameter, mm	Methods A, C: 101.60 ±0.40	Methods A, C: 101.60 ±0.4
	Methods B, D: 152.40 ±0.70	Methods B, D: 152.40 ±0.70
Mold Height, mm	116.40 ±0.50	116.40 ±0.50
Detachable Collar Height, mm	50.80 ±0.64	50.80 ±0.64
Rammer Diameter, mm	50.80 ±0.25	50.80 ±0.25
Rammer Mass, kg	2.495 ±0.009	4.536 ±0.009
Rammer Drop, mm	305 ±2	457 ±2
Layers	3	5
Blows per Layer	Methods A, C: 25	Methods A, C: 25
	Methods B, D: 56	Methods B, D: 56
Material Size, mm	Methods A, B: 4.75 minus	Methods A, B: 4.75 minus
	Methods C, D: 19.0 minus	Methods C, D: 19.0 minus
Test Sample Size, kg	Method A: 3 Method C: 5 (1)	Method B: 7 Method D: 11(1)
Energy, kN-m/m <sup>3</sup>	592	2,693

(1) This may not be a large enough sample depending on your nominal maximum size for moisture content samples.

**Table 2**  
**Comparison of Apparatus, Sample, and Procedure – English**

	T 99	T 180
Mold Volume, ft <sup>3</sup>	Methods A, C: 0.0333 ±0.0005	Methods A, C: 0.0333 ±0.0005
	Methods B, D: 0.07500 ±0.0009	Methods B, D: 0.07500 ±0.0009
Mold Diameter, in.	Methods A, C: 4.000 ±0.016	Methods A, C: 4.000 ±0.016
	Methods B, D: 6.000 ±0.026	Methods B, D: 6.000 ±0.026
Mold Height, in.	4.584 ±0.018	4.584 ±0.018
Detachable Collar Height, in.	2.000 ±0.025	2.000 ±0.025
Rammer Diameter, in.	2.000 ±0.025	2.000 ±0.025
Rammer Mass, lb	5.5 ±0.02	10 ±0.02
Rammer Drop, in.	12 ±0.06	18 ±0.06
Layers	3	5
Blows per Layer	Methods A, C: 25	Methods A, C: 25
	Methods B, D: 56	Methods B, D: 56
Material Size, in.	Methods A, B: No. 4 minus	Methods A, B: No.4 minus
	Methods C, D: 3/4 minus	Methods C, D: 3/4 minus
Test Sample Size, lb	Method A: 7 Method C: 12 <sub>(1)</sub>	Method B: 16 Method D: 25 <sub>(1)</sub>
Energy, lb-ft/ft <sup>3</sup>	12,375	56,250

(1) This may not be a large enough sample depending on your nominal maximum size for moisture content samples.

## Sample

If the sample is damp, dry it until it becomes friable under a trowel. Drying may be in air or by use of a drying apparatus maintained at a temperature not exceeding 60°C (140°F). Thoroughly break up aggregations in a manner that avoids reducing the natural size of individual particles.

Obtain a representative test sample of the mass required by the agency by passing the material through the sieve required by the agency. See Table 1 or Table 2 for test sample mass and material size requirements.

In instances where the material is prone to degradation, i.e., granular material, a compaction sample with differing moisture contents should be prepared for each point.

If the sample is plastic (clay types), it should stand for a minimum of 12 hours after the addition of water to allow the moisture to be absorbed. In this case, several samples at different moisture contents should be prepared, put in sealed containers, and tested the next day.

*Note 1:* Both T 99 and T 180 have four methods (A, B, C, D) that require different masses and employ different sieves.

## Procedure

During compaction, rest the mold firmly on a dense, uniform, rigid, and stable foundation, or base. This base shall remain stationary during the compaction process.

1. Determine the mass of the clean, dry mold. Include the base plate but exclude the extension collar. Record the mass to the nearest 1 g (0.005 lb).
2. Thoroughly mix the selected representative sample with sufficient water to dampen it to approximately 4 to 8 percentage points below optimum moisture content. For many materials, this condition can be identified by forming a cast by hand.
  - a. Prepare individual samples of plastic or degradable material, increasing moisture contents 1 to 2 percent for each point.
  - b. Allow samples of plastic soil to stand for 12 hrs.
3. Form a specimen by compacting the prepared soil in the mold assembly in approximately equal layers. For each layer:
  - a. Spread the loose material uniformly in the mold.

*Note 2:* It is recommended to cover the remaining material with a non-absorbent sheet or damp cloth to minimize loss of moisture.

- b. Lightly tamp the loose material with the manual rammer or other similar device, this establishes a firm surface.
    - c. Compact each layer with uniformly distributed blows from the rammer. See Table 1 for mold size, number of layers, number of blows, and rammer specification for the various test methods. Use the method specified by the agency.
    - d. Trim down material that has not been compacted and remains adjacent to the walls of the mold and extends above the compacted surface.

EMBANKMENT AND BASE  
IN-PLACE DENSITY

WAQTC

FOP AASHTO T 99/T 180 (22)

4. Remove the extension collar. Avoid shearing off the sample below the top of the mold. The material compacted in the mold should not be over 6 mm (¼ in.) above the top of the mold once the collar has been removed.
5. Trim the compacted soil even with the top of the mold with the beveled side of the straightedge.
6. Clean soil from exterior of the mold and base plate.
7. Determine and record the mass of the mold, base plate, and wet soil to the nearest 1 g (0.005 lb).
8. Determine and record the wet mass ( $M_w$ ) of the sample by subtracting the mass in Step 1 from the mass in Step 7.
9. Calculate the wet density ( $\rho_w$ ), in  $\text{kg/m}^3$  ( $\text{lb/ft}^3$ ), by dividing the wet mass by the measured volume ( $V_m$ ).
10. Extrude the material from the mold. For soils and soil-aggregate mixtures, slice vertically through the center and remove one of the cut faces for a representative moisture content sample. For granular materials, a vertical face will not exist. Take a representative sample ensuring that all layers are represented. This sample must meet the sample size requirements of the test method used to determine moisture content.



**Extruded material**

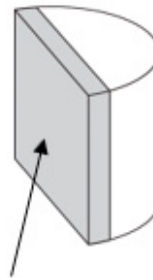

**Representative moisture  
content sample**

**Note 3:** When developing a curve for free-draining soils such as uniform sands and gravels, where seepage occurs at the bottom of the mold and base plate, taking a representative moisture content from the mixing bowl may be preferred in order to determine the amount of moisture available for compaction.

11. Determine and record the moisture content ( $w$ ) of the sample in accordance with the FOP for AASHTO T 255 / T 265.
12. If the material is degradable or plastic, return to Step 3 using a prepared individual sample. If not, continue with Steps 13 through 15.
13. Thoroughly break up the remaining portion of the molded specimen until it will again pass through the sieve, as judged by eye, and add to the remaining portion of the sample being tested.
14. Add sufficient water to increase the moisture content of the remaining soil by 1 to 2 percentage points and repeat steps 3 through 11.

15. Continue determinations until there is either a decrease or no change in the wet mass. There will be a minimum of three points on the dry side of the curve and two points on the wet side. For non-cohesive, drainable soils, one point on the wet side is sufficient.

## Calculations

### Wet Density

$$\rho_w = \frac{M_w}{V_m}$$

Where:

- $\rho_w$  = wet density, kg/m<sup>3</sup> (lb/ft<sup>3</sup>)  
 $M_w$  = wet mass  
 $V_m$  = volume of the mold, Annex B

### Dry Density

$$\rho_d = \left( \frac{\rho_w}{w + 100} \right) \times 100 \quad \text{or} \quad \rho_d = \frac{\rho_w}{\left( \frac{w}{100} \right) + 1}$$

Where:

- $\rho_d$  = dry density, kg/m<sup>3</sup> (lb/ft<sup>3</sup>)  
 $w$  = moisture content, as a percentage

### Example for 4-inch mold, Methods A or C

- Wet mass,  $M_w$  = 1.928 kg (4.25 lb)  
 Moisture content,  $w$  = 11.3%  
 Measured volume of the mold,  $V_m$  = 0.000946 m<sup>3</sup> (0.0334 ft<sup>3</sup>)

### Wet Density

$$\rho_w = \frac{1.928 \text{ kg}}{0.000946 \text{ m}^3} = 2038 \text{ kg/m}^3 \quad \rho_w = \frac{4.25 \text{ lb}}{0.0334 \text{ ft}^3} = 127.2 \text{ lb/ft}^3$$

Where:

$$\rho_w = \text{Wet density, kg/m}^3 \text{ (lb/ft}^3\text{)}$$

**Dry Density**

$$\rho_d = \left( \frac{2038 \text{ kg/m}^3}{11.3 + 100} \right) \times 100 = 1831 \text{ kg/m}^3 \quad \rho_d = \left( \frac{127.2 \text{ lb/ft}^3}{11.3 + 100} \right) \times 100 = 114.3 \text{ lb/ft}^3$$

Or

$$\rho_d = \left( \frac{2038 \text{ kg/m}^3}{\frac{11.3}{100} + 1} \right) = 1831 \text{ kg/m}^3 \quad \rho_d = \left( \frac{127.2 \text{ lb/ft}^3}{\frac{11.3}{100} + 1} \right) = 114.3 \text{ lb/ft}^3$$

$$\rho_d = \text{Dry density, kg/m}^3 \text{ (lb/ft}^3\text{)}$$

**Moisture-Density Curve Development**

When dry density is plotted on the vertical axis versus moisture content on the horizontal axis and the points are connected with a smooth line, a moisture-density curve is developed. The coordinates of the peak of the curve are the maximum dry density, or just “maximum density,” and the “optimum moisture content” of the soil.

**Example**

Given the following dry density and corresponding moisture content values develop a moisture-density relations curve and determine maximum dry density and optimum moisture content.

Dry Density		Moisture Content, %
kg/m <sup>3</sup>	lb/ft <sup>3</sup>	
1831	114.3	11.3
1853	115.7	12.1
1873	116.9	12.8
1869	116.7	13.6
1857	115.9	14.2

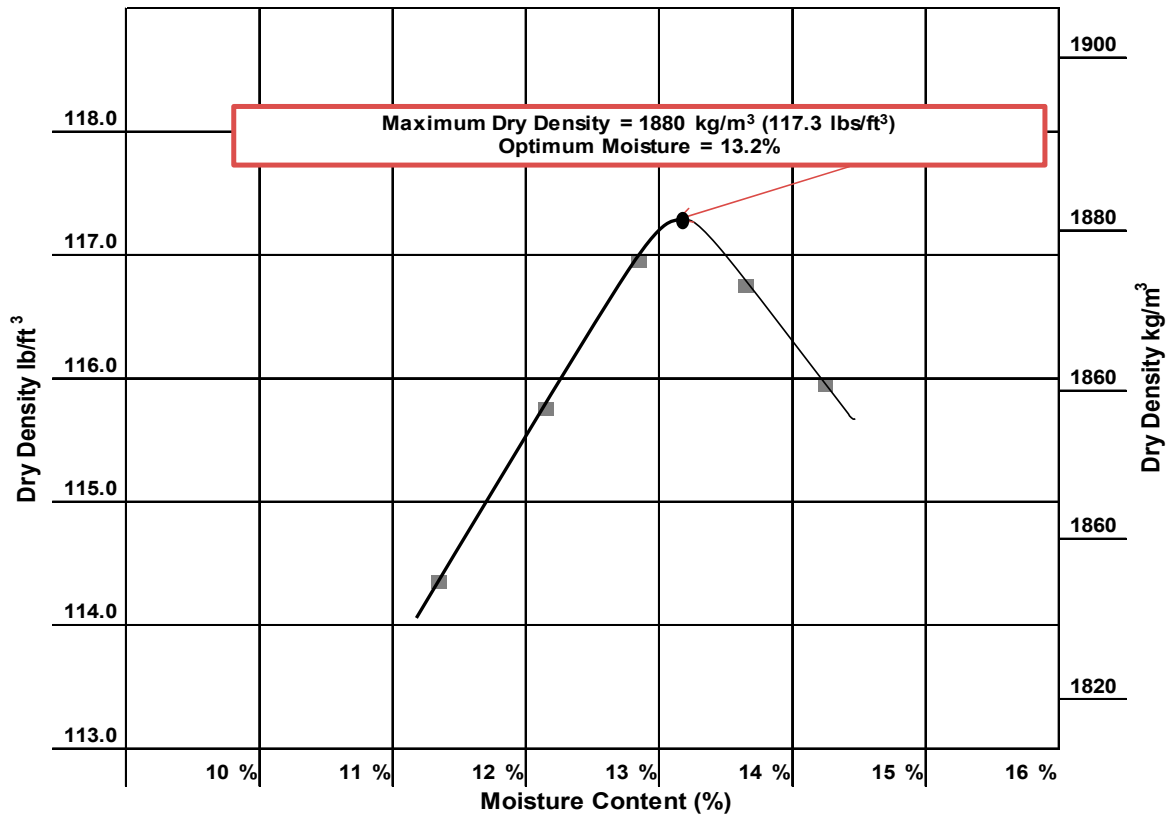

In this case, the curve has its peak at:

Maximum dry density	=	1880 kg/m <sup>3</sup> (117.3 lb/ft <sup>3</sup> )
Optimum moisture content	=	13.2%

Note that both values are approximate since they are based on sketching the curve to fit the points.

## Report

- Results on forms approved by the agency
- Sample ID
- Maximum dry density to the nearest 1 kg/m<sup>3</sup> (0.1 lb/ft<sup>3</sup>)
- Optimum moisture content to the nearest 0.1 percent



**ANNEX A****CORRECTION OF MAXIMUM DRY DENSITY AND OPTIMUM MOISTURE FOR OVERSIZED PARTICLES**

(Mandatory Information)

This section corrects the maximum dry density and moisture content of the material retained on the 4.75 mm (No. 4) sieve, Methods A and B; or the material retained on the 19 mm (¾ in.) sieve, Methods C and D. The maximum dry density, corrected for oversized particles and total moisture content, are compared with the field-dry density and field moisture content.

This correction can be applied to the sample on which the maximum dry density is performed. A correction may not be practical for soils with only a small percentage of oversize material. The agency shall specify a minimum percentage below which the method is not needed. If not specified, this method applies when more than 5 percent by weight of oversize particles is present.

Bulk specific gravity ( $G_{sb}$ ) of the oversized particles is required to determine the corrected maximum dry density. Use the bulk specific gravity as determined using the FOP for AASHTO T 85 in the calculations. For construction activities, an agency established value or specific gravity of 2.600 may be used.

This correction can also be applied to the sample obtained from the field while performing in-place density.

**Procedure**

1. Use the sample from this procedure or a sample obtained according to the FOP for AASHTO T 310.
2. Sieve the sample on the 4.75 mm (No. 4) sieve for Methods A and B or the 19 mm (¾ in.) sieve, Methods C and D.
3. Determine the dry mass of the oversized and fine fractions ( $M_{DC}$  and  $M_{DF}$ ) by one of the following:
  - a. Dry the fractions, fine and oversized, in air or by use of a drying apparatus that is maintained at a temperature not exceeding 60°C (140°F).
  - b. Calculate the dry masses using the moisture samples.

To determine the dry mass of the fractions using moisture samples.

1. Determine the moist mass of both fractions, fine ( $M_{Mf}$ ) and oversized ( $M_{Mc}$ ):
2. Obtain moisture samples from the fine and oversized material.
3. Determine the moisture content of the fine particles ( $MC_f$ ) and oversized particles ( $MC_c$ ) of the material by FOP for AASHTO T 255/T 265 or agency approved method.
4. Calculate the dry mass of the oversize and fine particles.

$$M_D = \frac{M_m}{1 + MC}$$

Where:

$M_D$  = mass of dry material (fine or oversize particles)

$M_m$  = mass of moist material (fine or oversize particles)

MC = moisture content of respective fine or oversized, expressed as a decimal

5. Calculate the percentage of the fine ( $P_f$ ) and oversized ( $P_c$ ) particles by dry weight of the total sample as follows: See Note 2.

$$P_f = \frac{100 \times M_{DF}}{M_{DF} + M_{DC}} \quad \frac{100 \times 15.4 \text{ lb}}{15.4 \text{ lbs} + 5.7 \text{ lb}} = 73\% \quad \frac{100 \times 6.985 \text{ kg}}{6.985 \text{ kg} + 2.585 \text{ kg}} = 73\%$$

And

$$P_c = \frac{100 \times M_{DC}}{M_{DF} + M_{DC}} \quad \frac{100 \times 5.7 \text{ lb}}{15.4 \text{ lbs} + 5.7 \text{ lb}} = 27\% \quad \frac{100 \times 2.585 \text{ kg}}{6.985 \text{ kg} + 2.585 \text{ kg}} = 27\%$$

Or for  $P_c$ :

$$P_c = 100 - P_f$$

Where:

$P_f$  = percent of fine particles, of sieve used, by weight

$P_c$  = percent of oversize particles, of sieve used, by weight

$M_{DF}$  = mass of dry fine particles

$M_{DC}$  = mass of dry oversize particles

**Optimum Moisture Correction Equation**

1. Calculate the corrected moisture content as follows:

$$MC_T = \frac{(MC_F \times P_f) + (MC_C \times P_c)}{100} = \frac{(13.2\% \times 73.0\%) + (2.1\% \times 27.0\%)}{100} = 10.2\%$$

$MC_T$  = corrected moisture content of combined fines and oversized particles, expressed as a % moisture

$MC_F$  = moisture content of fine particles, as a % moisture

$MC_C$  = moisture content of oversized particles, as a % moisture

**Note 1:** Moisture content of oversize material can be assumed to be two (2) percent for most construction applications.

**Note 2:** In some field applications agencies will allow the percentages of oversize and fine materials to be determined with the materials in the wet state.

**Density Correction Equation**

2. Calculate the corrected dry density ( $\rho_d$ ) of the total sample (combined fine and oversized particles) as follows:

$$\rho_d = \frac{100\%}{\left[\left(\frac{P_f}{\rho_f}\right) + \left(\frac{P_c}{k}\right)\right]}$$

Where:

$\rho_d$  = corrected total dry density (combined fine and oversized particles)  
kg/m<sup>3</sup> (lb/ft<sup>3</sup>)

$\rho_f$  = dry density of the fine particles kg/m<sup>3</sup> (lb/ft<sup>3</sup>), determined in the lab

$P_c$  = percent of dry oversize particles, of sieve used, by weight.

$P_f$  = percent of dry fine particles, of sieve used, by weight.

$k$  = Metric: 1,000 \* Bulk Specific Gravity ( $G_{sb}$ ) (oven dry basis)  
of coarse particles (kg/m<sup>3</sup>).

$k$  = English: 62.4 \* Bulk Specific Gravity ( $G_{sb}$ ) (oven dry basis)  
of coarse particles (lb/ft<sup>3</sup>)

**Note 3:** If the specific gravity is known, then this value will be used in the calculation. For most construction activities the specific gravity for aggregate may be assumed to be 2.600.

**Calculation****Example**

## • Metric:

Maximum laboratory dry density ( $\rho_f$ ):	1880 kg/m <sup>3</sup>
Percent coarse particles ( $P_c$ ):	27%
Percent fine particles ( $P_f$ ):	73%
Mass per volume coarse particles (k):	(2.697) (1000) = 2697 kg/m <sup>3</sup>

$$\rho_d = \frac{100\%}{\left[\left(\frac{P_f}{\rho_f}\right) + \left(\frac{P_c}{k}\right)\right]}$$

$$\rho_d = \frac{100\%}{\left[\left(\frac{73\%}{1880 \text{ kg/m}^3}\right) + \left(\frac{27\%}{2697 \text{ kg/m}^3}\right)\right]}$$

$$\rho_d = \frac{100\%}{[0.03883 \text{ kg/m}^3 + 0.01001 \text{ kg/m}^3]}$$

$$\rho_d = 2047.5 \text{ kg/m}^3 \text{ report } 2048 \text{ kg/m}^3$$

EMBANKMENT AND BASE  
IN-PLACE DENSITY

WAQTC

FOP AASHTO T 99/T 180 (22)

English:

Maximum laboratory dry density ( $\rho_f$ ): 117.3 lb/ft<sup>3</sup>

Percent coarse particles ( $P_c$ ): 27%

Percent fine particles ( $P_f$ ): 73%

Mass per volume of coarse particles ( $k$ ): (2.697) (62.4) = 168.3 lb/ft<sup>3</sup>

$$\rho_d = \frac{100\%}{\left[\left(\frac{P_f}{\rho_f}\right) + \left(\frac{P_c}{k}\right)\right]}$$

$$\rho_d = \frac{100\%}{\left[\left(\frac{73\%}{117.3 \text{ lb/ft}^3}\right) + \left(\frac{27\%}{168.3 \text{ lb/ft}^3}\right)\right]}$$

$$\rho_d = \frac{100\%}{[0.6223 \text{ lb/ft}^3 + 0.1604 \text{ lb/ft}^3]}$$

$$\rho_d = \frac{100\%}{0.7827 \text{ lb/ft}^3}$$

$$\rho_d = 127.76 \text{ lb/ft}^3 \quad \text{Report } 127.8 \text{ lb/ft}^3$$

## Report

- On forms approved by the agency
- Sample ID
- Corrected maximum dry density to the nearest 1 kg/m<sup>3</sup> (0.1 lb/ft<sup>3</sup>)
- Corrected optimum moisture to the nearest 0.1 percent

---

**ANNEX B****STANDARDIZATION OF THE MOLD**

(Mandatory Information)

Standardization is a critical step to ensure accurate test results when using this apparatus. Failure to perform the standardization procedure as described herein will produce inaccurate or unreliable test results.

**Apparatus**

- Mold and base plate
- Balance or scale – Accurate to within 45 g (0.1 lb) or 0.3 percent of the test load, whichever is greater, at any point within the range of use.
- Cover plate – A piece of plate glass, at least 6 mm (1/4 in.) thick and at least 25 mm (1 in.) larger than the diameter of the mold.
- Thermometers – Standardized liquid-in-glass, or electronic digital total immersion type, accurate to 0.5°C (1°F)

**Procedure**

1. Create a watertight seal between the mold and base plate.
2. Determine and record the mass of the dry sealed mold, base plate, and cover plate.
3. Fill the mold with water at a temperature between 16°C and 29°C (60°F and 85°F) and cover with the cover plate in such a way as to eliminate bubbles and excess water.
4. Wipe the outside of the mold, base plate, and cover plate dry, being careful not to lose any water from the mold.
5. Determine and record the mass of the filled mold, base plate, cover plate, and water.
6. Determine and record the mass of the water in the mold by subtracting the mass in Step 2 from the mass in Step 5.
7. Measure the temperature of the water and determine its density from Table B1, interpolating, as necessary.
8. Calculate the volume of the mold,  $V_m$ , by dividing the mass of the water in the mold by the density of the water at the measured temperature.

EMBANKMENT AND BASE  
IN-PLACE DENSITY

WAQTC

FOP AASHTO T 99/T 180 (22)

**Calculations**

$$V_m = \frac{M}{\rho_{water}}$$

Where:

 $V_m$  = volume of the mold

M = mass of water in the mold

 $\rho_{water}$  = density of water at the measured temperature**Example**

Mass of water in mold = 0.94367 kg (2.0800 lb)

 $\rho_{water}$  at 23°C (73.4°F) = 997.54 kg/m<sup>3</sup> (62.274 lb/ft<sup>3</sup>)

$$V_m = \frac{0.94367 \text{ kg}}{997.54 \text{ kg/m}^3} = 0.000946 \text{ m}^3 \quad V_m = \frac{2.0800 \text{ lb}}{62.274 \text{ lb/ft}^3} = 0.0334 \text{ ft}^3$$

**Table B1**  
**Unit Mass of Water**  
**15°C to 30°C**

°C	(°F)	kg/m <sup>3</sup>	(lb/ft <sup>3</sup> )	°C	(°F)	kg/m <sup>3</sup>	(lb/ft <sup>3</sup> )
15	(59.0)	999.10	(62.372)	23	(73.4)	997.54	(62.274)
15.6	(60.0)	999.01	(62.366)	23.9	(75.0)	997.32	(62.261)
16	(60.8)	998.94	(62.361)	24	(75.2)	997.29	(62.259)
17	(62.6)	998.77	(62.350)	25	(77.0)	997.03	(62.243)
18	(64.4)	998.60	(62.340)	26	(78.8)	996.77	(62.227)
18.3	(65.0)	998.54	(62.336)	26.7	(80.0)	996.59	(62.216)
19	(66.2)	998.40	(62.328)	27	(80.6)	996.50	(62.209)
20	(68.0)	998.20	(62.315)	28	(82.4)	996.23	(62.192)
21	(69.8)	997.99	(62.302)	29	(84.2)	995.95	(62.175)
21.1	(70.0)	997.97	(62.301)	29.4	(85.0)	995.83	(62.166)
22	(71.6)	997.77	(62.288)	30	(86.0)	995.65	(62.156)

EMBANKMENT AND BASE  
IN-PLACE DENSITY

WAQTC

FOP AASHTO T 99/T 180 (22)

### Report

- Mold ID
- Date Standardized
- Temperature of the water
- Volume,  $V_m$ , of the mold to the nearest  $0.000001 \text{ m}^3$  ( $0.0001 \text{ ft}^3$ )



**PERFORMANCE EXAM CHECKLIST**

**MOISTURE-DENSITY RELATION OF SOILS  
FOP FOR AASHTO T 99**

Participant Name: \_\_\_\_\_ Exam Date: \_\_\_\_\_ |

Record the symbols “P” for passing or “F” for failing on each step of the checklist.

<b>Procedure Element</b>	<b>Trial 1</b>	<b>Trial 2</b>
1. If damp, sample dried in air or drying apparatus, not exceeding 60°C (140°F)?	_____	_____
2. Sample broken up and an adequate amount sieved over the appropriate sieve (4.75 mm / No. 4 or 19.0 mm / 3/4 in.) to determine oversize (coarse particle) percentage?	_____	_____
3. Sample passing the sieve has appropriate mass?	_____	_____
4. If material is degradable:		
a. Multiple samples mixed with water varying moisture content by 1 to 2 percent, bracketing the optimum moisture content?	_____	_____
5. If soil is plastic (clay types):		
a. Multiple samples mixed with water varying moisture content by 1 to 2 percent, bracketing the optimum moisture content?	_____	_____
b. Samples placed in covered containers and allowed to stand for at least 12 hours?	_____	_____
6. Sample determined to be 4 to 8 percent below expected optimum moisture content?	_____	_____
7. Determine mass of clean, dry mold without collar to nearest 1 g (0.005 lb.)?	_____	_____
8. Mold placed on rigid and stable foundation?	_____	_____
9. Layer of soil (approximately one third compacted depth) placed in mold with collar attached, loose material lightly tamped?	_____	_____
10. Soil compacted with appropriate number of blows (25 or 56)?	_____	_____
11. Material adhering to the inside of the mold trimmed?	_____	_____
12. Layer of soil (approximately two thirds compacted depth) placed in mold with collar attached, loose material lightly tamped?	_____	_____
13. Soil compacted with appropriate number of blows (25 or 56)?	_____	_____
14. Material adhering to the inside of the mold trimmed?	_____	_____
15. Mold filled with soil such that compacted soil will be above the mold, loose material lightly tamped?	_____	_____

**OVER**

**Procedure Element**

**Trial 1    Trial 2**

- 16. Soil compacted with appropriate number of blows (25 or 56)? \_\_\_\_\_
- 17. Collar removed without shearing off sample? \_\_\_\_\_
- 18. Approximately 6 mm (1/4 in.) of compacted material above the top of the mold (without the collar)? \_\_\_\_\_
- 19. Soil trimmed to top of mold with the beveled side of the straightedge? \_\_\_\_\_
- 20. Remove all soil from exterior surface of mold and base plate? \_\_\_\_\_
- 21. Mass of mold and contents determined to nearest 1 g (0.005 lb.)? \_\_\_\_\_
- 22. Wet density calculated from the wet mass? \_\_\_\_\_
- 23. Soil removed from mold using a sample extruder if needed? \_\_\_\_\_
- 24. Soil sliced vertically through center (non-granular material)? \_\_\_\_\_
- 25. Moisture sample removed ensuring all layers are represented? \_\_\_\_\_
- 26. Moist mass determined immediately to 0.1 g? \_\_\_\_\_
- 27. Moisture sample mass of correct size? \_\_\_\_\_
- 28. Sample dried, and water content determined according to the FOP for T 255/T 265? \_\_\_\_\_
- 29. Remainder of material from mold broken up until it will pass through the sieve, as judged by eye, and added to remainder of original test sample? \_\_\_\_\_
- 30. Water added to increase moisture content of the remaining sample in approximately 1 to 2 percent increments? \_\_\_\_\_
- 31. Steps 7 through 29 repeated for each increment of water added? \_\_\_\_\_
- 32. Process continued until wet density either decreases or stabilizes? \_\_\_\_\_
- 33. Moisture content and dry density calculated for each sample? \_\_\_\_\_
- 34. Dry density plotted on vertical axis, moisture content plotted on horizontal axis, and points connected with a smooth curve? \_\_\_\_\_
- 35. Moisture content at peak of curve recorded as optimum water content and recorded to nearest 0.1 percent? \_\_\_\_\_
- 36. Dry density at optimum moisture content reported as maximum density to nearest 1 kg/m<sup>3</sup> (0.1 lb/ft<sup>3</sup>)? \_\_\_\_\_
- 37. Corrected for coarse particles if applicable? \_\_\_\_\_

Comments:      First attempt:    Pass\_\_\_\_\_Fail\_\_\_\_\_      Second attempt:    Pass\_\_\_\_\_Fail\_\_\_\_\_

\_\_\_\_\_  
 \_\_\_\_\_  
 \_\_\_\_\_

Examiner Signature \_\_\_\_\_ WAQTC #: \_\_\_\_\_

# WSDOT Errata to FOP for AASHTO R 100

## ***Method of Making and Curing Concrete Test Specimens in the Field***

WAQTC FOP for AASHTO R 100 has been adopted by WSDOT with the following changes:

### **Scope**

*Include note below:*

**Note:** WSDOT testing for determining compressive strength of concrete cylinder specimens shall require a set of two specimens made from the same sample.

### **Apparatus**

- Initial curing facilities:

*Include details below:*

Cure Box – The cure box shall be a commercially manufactured cure box meeting AASHTO R 100 standards and the following requirements:

1. The interior shall be rustproof with a moisture-proof seal between the lid and the box.
2. The lid shall lock or have loops for padlocks that allow the box to be locked.
3. The box shall be equipped with a heating and cooling system. If the system uses a water circulating system, the box shall be equipped with a bottom drain and an overflow port. The cure box shall provide an environment that prevents loss of moisture from the specimens. The curing temperature and moist environment shall be controlled by the use of heating and cooling devices installed in the cure box.

### **Procedure – Initial Curing**

**Method 2 – Initial cure by burying in earth or by using a curing box over the cylinder – *Method not recognized by WSDOT.***

*Include item below when required:*

### **Field Curing**

If the specimens are made and field cured, as stipulated herein, the resulting strength test data when the specimens are tested are able to be used for the following purposes:

- Determination of whether a structure is capable of being put in service.
- Comparison with test results of standard cured specimens or with test results from various in-place test methods,
- Adequacy of curing and protection of concrete in the structure.
- Form or shoring removal time requirements.

**Cylinders** – Store cylinders in or on the structure as near to the point of deposit of the concrete represented as possible. Protect all surfaces of the cylinders from the elements in as near as possible the same way as the formed work. Provide the cylinders with the same temperature and moisture environment as the structural work. Test the specimens in the moisture condition resulting from the specified curing treatment. To meet these conditions, specimens made for the purpose of determining when a structure is capable of being put in service shall be removed from the molds at the time of removal of form work.

**Beams** – After applying the curing compound to the top surface, cover the beam specimen with white reflective sheeting and allow beams to remain undisturbed for an initial cure period of  $24 \pm 4$  hours at ambient conditions. After the initial cure period, remove the specimen from the mold and cure the specimen either by:

- (1) Burying the specimen in wet sand making sure that the specimen is never allowed to become surface dry. Temperature of the sand should be similar to the concrete pavement temperature.

Or

- (2) Wrap the beam in a saturated towel, place in a plastic bag, and seal the opening. The plastic should be at least 4 mils thick. Leave the specimen on the pavement in the vicinity where it was molded until time to test. Take specimen to the testing location and store in lime water at  $73.4^\circ \pm 5^\circ\text{F}$  ( $23^\circ \pm 2.8^\circ\text{C}$ ) for  $24 \pm 4$  hours immediately before time of testing to ensure uniform moisture condition from specimen to specimen.

**Note:** The beam specimen must be kept in a surface moist condition or wet environment for the entire time in storage and testing. Even minor amounts of surface drying of the specimen induces extreme fiber stresses which can markedly reduce the flexural strength.

CONCRETE

WAQTC

FOP AASHTO R 100 (23)

## METHOD OF MAKING AND CURING CONCRETE TEST SPECIMENS IN THE FIELD FOP FOR AASHTO R 100

### Scope

This practice covers the method for making, initially curing, and transporting concrete test specimens in the field in accordance with AASHTO R 100-23.

**Warning**—Fresh Hydraulic cementitious mixtures are caustic and may cause chemical burns to skin and tissue upon prolonged exposure.

### Apparatus

- Concrete cylinder molds: Conforming to AASHTO M 205 with a length equal to twice the diameter. Standard specimens shall be 150 mm (6 in.) by 300 mm (12 in.) cylinders. Mold diameter must be at least three times the maximum aggregate size unless wet sieving is conducted according to the FOP for WAQTC TM 2. Agency specifications may allow cylinder molds of 100 mm (4 in.) by 200 mm (8 in.) when the nominal maximum aggregate size does not exceed 25 mm (1 in.).
- Beam molds: Rectangular in shape with ends and sides at right angles to each other. Must be sufficiently rigid to resist warpage. Surfaces must be smooth. Molds shall produce length no more than 1.6 mm (1/16 in.) shorter than that required (greater length is allowed). Maximum variation from nominal cross section shall not exceed 3.2 mm (1/8 in.). Ratio of width to depth may not exceed 1:5; the smaller dimension must be at least 3 times the maximum aggregate size. Standard beam molds shall result in specimens having width and depth of not less than 150 mm (6 in.). Agency specifications may allow beam molds of 100 mm (4 in.) by 100 mm (4 in.) when the nominal maximum aggregate size does not exceed 25 mm (1 in.). Specimens shall be cast and hardened with the long axes horizontal.
- Standard tamping rod: 16 mm (5/8 in.) in diameter and 400 mm (16 in.) to 600 mm (24 in.) long, having a hemispherical tip of the same diameter as the rod for preparing 150 mm (6 in.) x 300 mm (12 in.) cylinders.
- Small tamping rod: 10 mm (3/8 in.) diameter and 305 mm (12 in.) to 600 mm (24 in.) long, having a hemispherical tip of the same diameter as the rod for preparing 100 mm (4 in.) x 200 mm (8 in.) cylinders.
- Vibrator: At least 9000 vibrations per minute, with a diameter no more than ¼ the diameter or width of the mold and at least 75 mm (3 in.) longer than the section being vibrated.
- Scoop: a receptacle of appropriate size so that each representative increment of the concrete sample can be placed in the container without spillage.
- Trowel or float
- Mallet: With a rubber or rawhide head having a mass of  $0.57 \pm 0.23$  kg ( $1.25 \pm 0.5$  lb.).

CONCRETE

WAQTC

FOP AASHTO R 100 (23)

- Rigid base plates and cover plates: may be metal, glass, or plywood.
- Initial curing facilities: Temperature-controlled curing box or enclosure capable of maintaining the required range of 16 to 27°C (60 to 80°F) during the entire initial curing period (for concrete with compressive strength of 40 Mpa (6000 psi) or more, the temperature shall be 20 to 26°C (68 to 78°F). As an alternative, sand or earth for initial cylinder protection may be used provided that the required temperature range is maintained, and the specimens are not damaged.
- Thermometer: Capable of registering both maximum and minimum temperatures during the initial cure meeting the requirements for FOP for AASHTO T 309.

### Consolidation Selection

There are two methods of consolidating the concrete – rodding and internal vibration. If the slump is greater than 25 mm (1 in.), consolidation may be by rodding or vibration. When the slump is 25 mm (1 in.) or less, consolidate the sample by internal vibration. Agency specifications may dictate when rodding or vibration will be used.

### Procedure

#### Molding Specimens – General

1. Obtain the sample according to the FOP for WAQTC TM 2.
2. Wet Sieving per the FOP for WAQTC TM 2 is required for 150 mm (6 in.) diameter specimens containing aggregate with a nominal maximum size greater than 50 mm (2 in.); screen the sample over the 50 mm (2 in.) sieve.
3. Remix the sample after transporting to testing location.
4. Begin making specimens within 15 minutes of obtaining the sample.
5. Set molds upright on a level, rigid base in a location free from vibration and relatively close to where they will be stored.
6. Fill molds in the required number of layers, overfilling the mold on the final layer.

#### Casting Cylinders

There are two sizes for molding for compressive strength specimens, 150 mm (6 in.) by 300 mm (12 in.) and 100 mm (4 in.) by 200 mm (8 in.).

#### Rodding

##### 150 mm (6 in.) by 300 mm (12 in.)

1. Use the scoop to fill the mold approximately 1/3 full with concrete. Evenly distribute the concrete in a circular motion around the inner perimeter of the mold.
2. Consolidate the layer with 25 strokes of the standard tamping rod (16 mm (5/8 in.)), using the rounded end. Distribute the strokes evenly over the entire cross section of the concrete. Rod throughout its depth without hitting the bottom too hard.

## CONCRETE

## WAQTC

## FOP AASHTO R 100 (23)

3. Tap around the perimeter of the mold smartly 10 to 15 times with the mallet (reusable steel molds) or lightly with the open hand (single-use light-gauge molds) to close voids and release trapped air.
4. Add the second layer, filling the mold about 2/3 full. Evenly distribute the concrete in a circular motion around the inner perimeter of the mold.
5. Consolidate this layer with 25 strokes of the standard tamping rod, penetrating about 25 mm (1 in.) into the bottom layer.
6. Tap around the perimeter of the mold smartly 10 to 15 times with the mallet (reusable steel molds) or lightly with the open hand (single-use light-gauge molds).
7. Add the final layer, slightly overfilling the mold. Evenly distribute the concrete in a circular motion around the inner perimeter of the mold.
8. Consolidate this layer with 25 strokes of the tamping rod, penetrating about 25 mm (1 in.) into the second layer.
9. Tap around the perimeter of the mold smartly 10 to 15 times with the mallet (reusable steel molds) or lightly with the open hand (single-use light-gauge molds).
10. Strike off the surface of the molds with tamping rod, straightedge, float, or trowel.
11. Immediately begin initial curing.

**100 mm (4 in.) by 200 mm (8 in.)**

1. Use the scoop to fill the mold approximately 1/2 full with concrete. Evenly distribute the concrete in a circular motion around the inner perimeter of the mold.
2. Consolidate the layer with 25 strokes of the small tamping rod (10 mm (3/8 in.)), using the rounded end. Distribute the strokes evenly over the entire cross section of the concrete. Rod throughout its depth without hitting the bottom too hard.
3. Tap around the perimeter of the mold smartly 10 to 15 times with the mallet (reusable steel molds) or lightly with the open hand (single-use light-gauge molds) to close voids and release trapped air.
4. Add the final layer, slightly overfilling the mold. Evenly distribute the concrete in a circular motion around the inner perimeter of the mold.
5. Consolidate this layer with 25 strokes of the tamping rod, penetrating about 25 mm (1 in.) into the second layer.
6. Tap around the perimeter of the mold smartly 10 to 15 times with the mallet (reusable steel molds) or lightly with the open hand (single-use light-gauge molds).
7. Strike off the surface of the molds with tamping rod, straightedge, float, or trowel.
8. Immediately begin initial curing.

CONCRETE

WAQTC

FOP AASHTO R 100 (23)

**Internal Vibration****Casting a 150 mm (6 in.) by 300 mm (12 in.) cylinder**

1. Use the scoop to fill the mold approximately 1/2 full with concrete. Evenly distribute the concrete in a circular motion around the inner perimeter of the mold.
2. Insert the vibrator at two different points. Do not let the vibrator touch the bottom or side of the mold. Remove the vibrator slowly, so that no air pockets are left in the material. Continue vibration only long enough to achieve proper consolidation of the concrete.
3. Tap around the perimeter of the mold smartly 10 to 15 times with the mallet (reusable steel molds) or lightly with the open hand (single-use light-gauge molds).
4. Use the scoop to fill the mold a bit over full. Evenly distribute the concrete in a circular motion around the inner perimeter of the mold.
5. Insert the vibrator at two different points, penetrating the first layer approximately 25 mm (1 in.). Do not let the vibrator touch the side of the mold. Remove the vibrator slowly, so that no air pockets are left in the material. Continue vibration only long enough to achieve proper consolidation of the concrete.
6. Tap around the perimeter of the mold smartly 10 to 15 times with the mallet (reusable steel molds) or lightly with the open hand (single-use light-gauge molds).
7. Strike off the surface of the molds with tamping rod, straightedge, float, or trowel.
8. Immediately begin initial curing.

**Casting a 100 mm (4 in.) by 200 mm (8 in.) cylinder**

1. Use the scoop to fill the mold approximately 1/2 full with concrete. Evenly distribute the concrete in a circular motion around the inner perimeter of the mold.
2. Insert the vibrator at one point. Do not let the vibrator touch the bottom or side of the mold. Remove the vibrator slowly, so that no air pockets are left in the material. Continue vibration only long enough to achieve proper consolidation of the concrete.
3. Use the scoop to fill the mold a bit over full. Evenly distribute the concrete in a circular motion around the inner perimeter of the mold.
4. Insert the vibrator at one point, penetrating the first layer approximately 25 mm (1 in.). Do not let the vibrator touch the side of the mold. Remove the vibrator slowly, so that no air pockets are left in the material. Continue vibration only long enough to achieve proper consolidation of the concrete.
5. Tap around the perimeter of the mold smartly 10 to 15 times with the mallet (reusable steel molds) or lightly with the open hand (single-use light-gauge molds).
6. Strike off the surface of the molds with tamping rod, straightedge, float, or trowel.
7. Immediately begin initial curing.



CONCRETE

WAQTC

FOP AASHTO R 100 (23)

**Self-Consolidating Concrete**

1. Use the scoop to slightly overfill the mold. Evenly distribute the concrete in a circular motion around the inner perimeter of the mold.
2. Strike off the surface of the molds with tamping rod, straightedge, float, or trowel.
3. Immediately begin initial curing.

**Casting Flexural Beams****Rodding**

1. Fill the mold in two approximately equal layers with the second layer slightly overfilling the mold.
2. Consolidate each layer with the tamping rod once for every 1300 mm<sup>2</sup> (2 in<sup>2</sup>) using the rounded end. Rod each layer throughout its depth, taking care to not forcibly strike the bottom of the mold when compacting the first layer. Rod the second layer throughout its depth, penetrating approximately 25 mm (1 in.) into the lower layer.
3. After rodding each layer, strike the mold 10 to 15 times with the mallet and spade along the sides and end using a trowel.
4. Strike off the surface of the molds with tamping rod, straightedge, float, or trowel.
5. Immediately begin initial curing.

**Internal Vibration**

1. Fill the mold to overflowing in one layer.
2. Consolidate the concrete by inserting the vibrator vertically along the centerline at intervals not exceeding 150 mm (6 in.). Take care to not over-vibrate and withdraw the vibrator slowly to avoid large voids. Do not contact the bottom or sides of the mold with the vibrator.
3. After vibrating, strike the mold 10 to 15 times with the mallet.
4. Strike off the surface of the molds with tamping rod, straightedge, float, or trowel.
5. Immediately begin initial curing.

**Initial Curing**

- When moving cylinder specimens made with single use molds support the bottom of the mold with trowel, hand, or other device.
- For initial curing of cylinders, there are two methods, use of which depends on the agency. In both methods, the curing place must be firm, within ¼ in. of a level surface, and free from vibrations or other disturbances.
- Maintain initial curing temperature:
- 16 to 27°C (60 to 80°F) for concrete with design strength up to 40 Mpa (6000 psi).

- 20 to 26°C (68 to 78°F) for concrete with design strength of 40 Mpa (6000 psi) or more.
- Prevent loss of moisture.

#### **Method 1 – Initial cure in a temperature-controlled chest-type curing box**

1. Finish the cylinder using the tamping rod, straightedge, float, or trowel. The finished surface shall be flat with no projections or depressions greater than 3.2 mm (1/8 in.).
2. Place the mold in the curing box. When lifting light-gauge molds be careful to avoid distortion (support the bottom, avoid squeezing the sides).
3. Place the lid on the mold to prevent moisture loss.
4. Mark the necessary identification data on the cylinder mold and lid.

#### **Method 2 – Initial cure by burying in earth or by using a curing box over the cylinder**

*Note 2:* This procedure may not be the preferred method of initial curing due to problems in maintaining the required range of temperature.

1. Move the cylinder with excess concrete to the initial curing location.
2. Mark the necessary identification data on the cylinder mold and lid.
3. Place the cylinder on level sand or earth, or on a board, and pile sand or earth around the cylinder to within 50 mm (2 in.) of the top.
4. Finish the cylinder using the tamping rod, straightedge, float, or trowel. Use a sawing motion across the top of the mold. The finished surface shall be flat with no projections or depressions greater than 3.2 mm (1/8 in.).
5. If required by the agency, place a cover plate on top of the cylinder and leave it in place for the duration of the curing period, or place the lid on the mold to prevent moisture loss.

#### **Transporting Specimens**

- Initially cure the specimens for 24 to 48 hours. Transport specimens to the laboratory for final cure. Specimen identity will be noted along with the date and time the specimen was made and the maximum and minimum temperatures registered during the initial cure.
- Protect specimens from jarring, extreme changes in temperature, freezing, or moisture loss during transport.
- Secure cylinders so that the axis is vertical.
- Do not exceed 4 hours transportation time.

#### **Final Curing**

- Upon receiving cylinders at the laboratory, remove the cylinder from the mold and apply the appropriate identification.

- For all specimens (cylinders or beams), final curing must be started within 30 minutes of mold removal. Temperature shall be maintained at  $23^{\circ} \pm 2^{\circ}\text{C}$  ( $73 \pm 3^{\circ}\text{F}$ ). Free moisture must be present on the surfaces of the specimens during the entire curing period. Curing may be accomplished in a moist room or water tank conforming to AASHTO M 201.
- For cylinders, during the final 3 hours before testing the temperature requirement may be waived, but free moisture must be maintained on specimen surfaces at all times until tested and ambient temperature is between 20 to  $30^{\circ}\text{C}$  (68 to  $80^{\circ}\text{F}$ ).
- Final curing of beams must include immersion in lime-saturated water for at least 20 hours before testing.

**Report**

- On forms approved by the agency
- Pertinent placement information for identification of project, element(s) represented, etc.
- Sample ID
- Date and time molded.
- Test ages.
- Slump, air content, and density.
- Temperature (concrete, initial cure max. and min., and ambient).
- Method of initial curing.
- Other information as required by agency, such as: concrete supplier, truck number, invoice number, water added, etc.

**PERFORMANCE EXAM CHECKLIST**

**MAKING AND CURING CONCRETE TEST SPECIMENS IN THE FIELD  
FOP FOR AASHTO R 100 (4 X 8)**

Participant Name \_\_\_\_\_ Exam Date \_\_\_\_\_

Record the symbols “P” for passing or “F” for failing on each step of the checklist.

<b>Procedure Element</b>	<b>Trial 1</b>	<b>Trial 2</b>
1. Molds placed on a level, rigid, horizontal surface free of vibration?	_____	_____
2. Representative sample selected?	_____	_____
3. Making of specimens begun within 15 minutes of sampling?	_____	_____
<b>First layer</b>		
4. Concrete placed in the mold, moving a scoop or trowel around the perimeter of the mold to evenly distribute the concrete as discharged?	_____	_____
5. Mold filled approximately half full?	_____	_____
6. Layer rodded throughout its depth 25 times with hemispherical end of rod, uniformly distributing strokes?	_____	_____
7. Sides of the mold tapped 10-15 times after rodding?		
a. With mallet for reusable steel molds	_____	_____
b. With the open hand for flexible light-gauge molds	_____	_____
<b>Second layer</b>		
8. Concrete placed in the mold, moving a scoop or trowel around the perimeter of the mold to evenly distribute the concrete as discharged?	_____	_____
9. Mold slightly overfilled on the last layer?	_____	_____
10. Layer rodded 25 times with hemispherical end of rod, uniformly distributing strokes and penetrating 25 mm (1 in.) into the underlying layer?	_____	_____
11. Sides of the mold tapped 10-15 times after rodding each layer?		
a. With mallet for reusable steel molds	_____	_____
b. With the open hand for flexible light-gauge molds	_____	_____
12. Concrete struck off with tamping rod, float or trowel?	_____	_____
13. Specimens covered with non-absorptive, non-reactive cap or plate?	_____	_____
14. Initial curing addressed?	_____	_____

**OVER**

CONCRETE

WAQTC

FOP AASHTO R 100 (21)

Comments:      First attempt: Pass\_\_\_\_Fail\_\_\_\_      Second attempt: Pass\_\_\_\_Fail\_\_\_\_

---

---

---

Examiner Signature \_\_\_\_\_ WAQTC # \_\_\_\_\_

This checklist is derived, in part, from copyrighted material printed in ACI CP-1, published by the American Concrete Institute.

**PERFORMANCE EXAM CHECKLIST**

**MAKING AND CURING CONCRETE TEST SPECIMENS IN THE FIELD  
FOP FOR AASHTO R 100 (6 X 12)**

Participant Name \_\_\_\_\_ Exam Date \_\_\_\_\_

**Record the symbols “P” for passing or “F” for failing on each step of the checklist.**

<b>Procedure Element</b>	<b>Trial 1</b>	<b>Trial 2</b>
1. Molds placed on a level, rigid, horizontal surface free of vibration?	_____	_____
2. Representative sample selected?	_____	_____
3. Making of specimens begun within 15 minutes of sampling?	_____	_____
<b>First layer</b>		
4. Concrete placed in the mold, moving a scoop or trowel around the perimeter of the mold to evenly distribute the concrete as discharged?	_____	_____
5. Mold filled approximately one third full?	_____	_____
6. Layer rodded throughout its depth 25 times with hemispherical end of rod, uniformly distributing strokes?	_____	_____
7. Sides of the mold tapped 10-15 times after rodding each layer?		
a. With mallet for reusable steel molds	_____	_____
b. With the open hand for flexible light-gauge molds	_____	_____
<b>Second layer</b>		
8. Concrete placed in the mold, moving a scoop or trowel around the perimeter of the mold to evenly distribute the concrete as discharged?	_____	_____
9. Mold filled approximately two thirds full?	_____	_____
10. Layer rodded 25 times with hemispherical end of rod, uniformly distributing strokes and penetrating 25 mm (1 in.) into the underlying layer?	_____	_____
11. Sides of the mold tapped 10-15 times after rodding?		
a. With mallet for reusable steel molds	_____	_____
b. With the open hand for flexible light-gauge molds	_____	_____
<b>Third layer</b>		
12. Concrete placed in the mold, moving a scoop or trowel around the perimeter of the mold to evenly distribute the concrete as discharged?	_____	_____

**OVER**

<b>Procedure Element</b>	<b>Trial 1</b>	<b>Trial 2</b>
13. Mold slightly overfilled on the last layer?	_____	_____
14. Layer rodded 25 times with hemispherical end of rod, uniformly distributing strokes and penetrating 25 mm (1 in.) into the underlying layer?	_____	_____
15. Sides of the mold tapped 10-15 times after rodding?		
a. With mallet for reusable steel molds	_____	_____
b. With the open hand for flexible light-gauge molds	_____	_____
16. Concrete struck off with tamping rod, straightedge, float, or trowel?	_____	_____
17. Specimens covered with non-absorptive, non-reactive cap or plate?	_____	_____
18. Initial curing addressed?	_____	_____

Comments:      First attempt:    Pass \_\_\_\_\_ Fail \_\_\_\_\_      Second attempt:    Pass \_\_\_\_\_ Fail \_\_\_\_\_

---



---



---



---

Examiner Signature \_\_\_\_\_ WAQTC #: \_\_\_\_\_

This checklist is derived, in part, from copyrighted material printed in ACI CP-1, published by the American Concrete Institute.



## WSDOT FOP for AASHTO T 106

### *Compressive Strength of Hydraulic Cement Mortar (Using 50-mm or 2-in. Cube Specimens)*

WSDOT has adopted the published AASHTO T 106 with errata's below.

*AASHTO Test Methods cannot be included in Materials Manual due to copyright infringement.*

*WSDOT employees can access AASHTO and ASTM test methods in the following web address:*

[www.wsdot.wa.gov/tools-services/library-services/access-aashto-publications-and-astm-aci-or-sspc-standards](http://www.wsdot.wa.gov/tools-services/library-services/access-aashto-publications-and-astm-aci-or-sspc-standards)

*Non-WSDOT employees can order AASHTO's Standard Specifications for Transportation Materials and Methods of Sampling and Testing, using the following web address:*

<https://store.transportation.org>

#### **10. Procedure**

*Follow Note below.*

**Note:** For Field fabrication of grout cubes, follow WSDOT Test Method T 813.



# Performance Exam Checklist

## AASHTO T 106

### Compressive Strength of Hydraulic Cement Mortar (Using 50-mm or 2-in. Cube specimens)

Participant Name: \_\_\_\_\_ Exam Date: \_\_\_\_\_

Record the symbols "P" for passing or "F" for failing on each step of the checklist.

Procedure Element	Trial 1	Trial 2
1. The tester has a copy of the current procedure on hand?	_____	_____
2. All equipment is functioning according to the test procedure, and if required has the current calibration/standardization/check and maintenance tags present?	_____	_____
3. Cubes broken within permissible time tolerance?	_____	_____
4. Cubes tested immediately after removal from saturated lime water storage tank or covered with damp cloth?	_____	_____
5. Cubes wiped clean of sand, and wiped to surface dry condition prior to testing?	_____	_____
6. Load applied to specimen faces that were in contact with plane surfaces of mold and checked with straightedge?	_____	_____
7. Cross-sectional area determined in respect to faces contacting bearing blocks?	_____	_____
8. Prior to testing each cube, spherically seated block checked for freedom to tilt?	_____	_____
9. Load rate of 200 to 400 lbf/s (900-1800 N/s) obtained during the first half of the anticipated maximum load?	_____	_____
10. No adjustment in rate made during the second half of loading?	_____	_____
11. Total maximum load recorded and compressive strength of cubes averaged and reported to the nearest 10 psi (0.1 MPa)?	_____	_____

Comments: First Attempt: Pass \_\_\_\_\_ Fail \_\_\_\_\_ Second Attempt: Pass \_\_\_\_\_ Fail \_\_\_\_\_

Examiner Signature: \_\_\_\_\_ WAQTC #: \_\_\_\_\_



## **AASHTO T 112 (Modified)**

### ***Clay Lumps and Friable Particles in Aggregate***

AASHTO T 112 has been adopted by WSDOT.

The following definition for “Constant Mass” has been added to this procedure.

“Constant Mass - Test samples dried at a temperature of  $230 \pm 9^{\circ}\text{F}$  ( $110 \pm 5^{\circ}\text{C}$ ) to such a condition that it will not lose more than 0.1 per cent moisture after 2 hours of drying. Such a condition of dryness can be verified by determining the mass of the sample before and after successive 2 hour drying periods. In lieu of such determination, samples may be considered to have reached constant mass when they have been dried at a temperature of  $230 \pm 9^{\circ}\text{F}$  ( $110 \pm 5^{\circ}\text{C}$ ) for an equal or longer period than that previously found adequate for producing the desired constant mass condition under equal or heavier loading condition of the oven.”





## WSDOT Test Method T 113

### *Method of Test for Determination of Degradation Value*

#### 1. Scope

- a. This method covers the procedure for determining the susceptibility of an aggregate to degrade into plastic fines when abraded in the presence of water.

#### 2. Apparatus

- a. Balance – 5000 g capacity, sensitive to 0.1 g
- b. Degradation Shaker – Tyler Portable Sieve Shaker CL-305 modified to provide  $300 \pm 5$  oscillations per minute with a  $1\frac{3}{4}$  in (44.5 mm) throw on the cam or a shaker with equivalent movement
- c. Washing Canister – Shall be either Plastic or Steel meeting the following:
  - Plastic Canister –  $7\frac{1}{2}$  in  $\pm$   $\frac{1}{4}$  in (190.5 mm  $\pm$  6.3 mm) diameter x  $6 \pm \frac{1}{2}$  in (152.4 mm  $\pm$  12.5 mm) high. Sidewalls of the plastic canister should meet the bottom at 90 degrees with little or no fillet
  - Steel Canister: Meeting the requirements of AASHTO T 210 (ASTM D 3744)
- d. Sand equivalent graduated cylinder and rubber stopper
- e. Sand equivalent stock solution
- f. Sieves –  $\frac{1}{2}$  in (12.5 mm),  $\frac{3}{8}$  in (9.5 mm),  $\frac{1}{4}$  in (6.3 mm), U.S. No. 10 (2.00 mm) and U.S. No. 200 (0.075 mm) sieves conforming to the requirement of ASTM E11
- g. Graduates – 500 ml tall form, 100 ml
- h. Interval timer
- i. Funnel – Large enough to securely hold the nest of sieves and a mouth that fits into the 500 ml graduate
- j. Sieve Shaker – Shaker that meets the requirements of AASHTO T-27
- k. Oven – Sufficient size, capable of maintaining a uniform temperature of  $230 \pm 9^{\circ}\text{F}$  ( $110 \pm 5^{\circ}\text{C}$ )
- l. Sprayer – Water sprayer, device to produce a low volume stream of water. i.e. 500 ml wash bottle
- m. Suitable Containers – Pans for washing and drying

### 3. Sample Preparation

- a. If testing pit run material: dry at  $230 \pm 9^\circ\text{F}$  ( $110 \pm 5^\circ\text{C}$ ) to allow for clean separation from the fine material. Separate the material over the  $\frac{1}{2}$  in (12.5 mm) sieve and discard that finer than the  $\frac{1}{2}$  in (12.5 mm) and proceed to step 3d.
- b. If testing crushed and stockpiled material: dry at  $230 \pm 9^\circ\text{F}$  ( $110 \pm 5^\circ\text{C}$ ) to allow for clean separation from the fine material and proceed to step 3e.
- c. If testing quarry material: if necessary, separate the material over the  $\frac{1}{2}$  in (12.5 mm) sieve and discard that finer than the  $\frac{1}{2}$  in (12.5 mm).
- d. Crush the material to be tested to pass the  $\frac{1}{2}$  in sieve (12.5 mm).
- e. Split out an adequate amount of crushed material (approximately 5000 grams).
- f. Sieve the approx. 5000 g split over a  $\frac{1}{2}$  in (12.5 mm),  $\frac{3}{8}$  in (9.5 mm),  $\frac{1}{4}$  in (6.3 mm), and U.S. No. 10 (2.00 mm) screens in a sieve shaker. Steps should be taken to avoid overloading the sieves. Use shaking time determined to meet the requirement of AASHTO T 27 Section 8.2 for the shaker being used.

**Note 1:** When performing this test for Recycled Concrete Aggregate (RCA) the final sieve for the 5000 g split is the U.S. No. 4 instead of the U.S. No. 10.

- g. By splitting or quartering, obtain from the sieved material approximately 550 g of  $\frac{1}{2}$  -  $\frac{3}{8}$  (12.5-9.5 mm), 550 g of  $\frac{3}{8}$  -  $\frac{1}{4}$  (9.5-6.3 mm), and 1100 g of  $\frac{1}{4}$  - #10 (6.3-2.00 mm).
- h. Combine the  $\frac{1}{2}$  -  $\frac{3}{8}$  (12.5-9.5 mm) with the  $\frac{3}{8}$  -  $\frac{1}{4}$  (9.5-6.3 mm).
- i. Wash the  $\frac{1}{2}$  -  $\frac{1}{4}$  (12.5-6.3 mm) and  $\frac{1}{4}$  - #10 (6.3-2.00 mm) portions separately by placing in a container and adding sufficient water to cover it. Agitate vigorously to ensure complete separation of the material finer than No. 200 (0.075 mm) from coarser particles and bring the fine material into suspension above the coarser material.

**Note 2:** When performing this test for RCA use the  $\frac{1}{4}$ " - #4 instead of the  $\frac{1}{4}$ " - #10.

**Note 3:** The use of a mechanical aggregate washer is NOT permitted in the washing procedure.

Immediately pour the wash water containing the suspended and dissolved solids over a U.S. No. 10 (2.00 mm) sieve, being careful not to pour out the coarser particles. Add a second charge of water to the portion remaining in the container, agitate, and repeat the operation until the wash water is reasonably clear. Return all material retained on the sieve to the container. Repeat the process for the second portion.

- j. Place washed portions into suitable containers and dry to a constant weight at  $230 \pm 9^\circ\text{F}$  ( $110 \pm 5^\circ\text{C}$ ).
- k. Allow to cool to room temperature.
- l. From the washed and dried material, prepare two - 1000 g test samples as follows:
  1. Quarter or split the  $\frac{1}{2}$  -  $\frac{1}{4}$  (12.5-6.3 mm) to achieve two  $500 \pm 1$  g portions; hand selection of up to 50 g to attain the  $500 \pm 1$  grams is acceptable.
  2. Split the  $\frac{1}{4}$  - #10 (6.3-2.00 mm) to achieve two  $500 \pm 1$  g portions; hand selection of up to 50 g to attain the  $500 \pm 1$  grams is acceptable.
  3. Combine each of the  $\frac{1}{2}$  -  $\frac{1}{4}$  (12.5-6.3 mm) portions with one of the  $\frac{1}{4}$  - #10 (6.3-2.00 mm) portions to create two -  $1000 \pm 2$  g test samples consisting of  $\frac{1}{2}$  - #10 (12.5-2.00 mm) material.

**Note 4:** When performing this test for RCA use the  $\frac{1}{4}$ " - #4 instead of the  $\frac{1}{4}$ " - #10.



#### 4. Procedure

- a. Place one test sample in the washing canister, add  $200 \pm 5$  ml of water, cover tightly and place in degradation shaker.
- b. Immediately agitate the material for 20 minutes.
- c. At the end of the shaking time, empty the washing canister into nested U.S. No. 10 (2.00 mm) and U.S. No. 200 (0.075 mm) sieves fitted into the funnel placed over a 500 ml graduate to catch all wash water.

**Note 2:** IMPORTANT! It is critical to the test result that material finer than the U.S. No. 200 (0.075 m) is washed off the larger particles into the 500 ml graduate. This process has to be completed using approximately 300 ml of water such that the total amount water used in the test is only 500 ml. (200 ml with shaking, plus the 20-50 ml used for rinsing the canister and lid, plus that remaining to wash the fines off the particles) The process should be slow and meticulous, utilizing a high pressure, low volume spray of water. Use of a 500 ml squeeze type wash bottle has been found to work well for this process. The washing process should take 5 - 10 minutes.

- d. Rinse material finer than U.S. No. 200 (0.075 mm) off the lid into the washing canister and then from the washing canister into the nested sieves using minimal amount of water. (20-50 ml).
- e. Shake the nested sieves to spread the sample evenly. (Note 3).
- f. Wash the sample using only 20-50 ml. of water. (Note 2).
- g. Shake the nested sieves to release any water and 200- that may be sitting on the U.S. No. 200 (0.075 mm) sieve. (Note 3).
- h. Raise the funnel and tilt slightly, insure that the mouth of the funnel remains over the 500 ml graduate and catches all of the wash water, to allow the sieves to drain easier. Observe the liquid for clarity.
- i. Lower the funnel back into the 500 ml graduate.
- j. Repeat steps 4e. through 4i. until the liquid in the graduate reaches the 500 ml mark. Do not allow drainage above the 500 ml mark.

**Note 3:** Shaking should be vigorous enough to move the aggregate but with care such that no spillage of wash water or loss of aggregate occurs.

- k. Measure  $7 \pm 1$  ml of sand equivalent stock solution and pour into a sand equivalent cylinder.
- l. Bring all solids in the 500 ml graduate into suspension by capping the top with the palm of the hand and turning it completely upside down and back as rapidly as possible, allowing the air bubble to traverse from end to end. Repeat this cycle 10 times, shaking the graduate on the first inversion to release sediment on the bottom.
- m. After the tenth cycle, immediately pour the agitated liquid into the sand equivalent cylinder to the  $15 \pm 0.1$  inch. ( $381 \pm 2.5$  mm) mark before any settling occurs. (Note 4.)

**Note 4:** The pour should be immediate and continuous without pause. Allowing the agitated liquid to flow back into the 500 ml graduate and then resuming the pour will allow settling and yield inconsistent results.

- n. Insert rubber stopper into the sand equivalent cylinder and mix the contents by turning the cylinder completely upside down and back as rapidly as possible, allowing the bubble to traverse from end to end. Repeat this cycle 20 times.

- o. Gently place the sand equivalent cylinder on the table, remove stopper, and immediately start timer. Allow to stand undisturbed for 20 minutes. After 20 minutes read and record the height of the sediment column to the nearest 0.1 in (2.5 mm).
- p. Repeat steps 4a. thru 4o. for the second test sample.

## 5. Calculations

- a. Calculate the degradation factors for the two test samples using the following formula:

$$D_1 = \frac{(15-H_1)}{(15 + 1.75H_1) \times 100} \qquad D_2 = \frac{(15-H_2)}{(15 + 1.75H_2) \times 100}$$

**Note:** Table 1 may be used to determine the values of D1 and D2 by finding the corresponding H value.

- b. Average the two degradation factors if they meet the requirements of Section 6, Repeatability:

$$D = \frac{(D_1+D_2)}{2}$$

Where:

- D = Degradation Factor
- D<sub>1</sub> = Degradation Factor for the first test sample
- D<sub>2</sub> = Degradation Factor for the second test sample
- H<sub>1</sub> = Height of Sediment in first sand equivalent cylinder
- H<sub>2</sub> = Height of Sediment in second sand equivalent cylinder

- c. Report the Degradation Factor (D) to the nearest whole number.
- d. Degradation Factors range from 0 to 100, with higher values representing the best materials.

6. Repeatability

- a. The two test samples, D<sub>1</sub> & D<sub>2</sub> must agree within 6 points.
- b. Repeat the entire test if variation between the test samples exceeds 6 points, see following calculation:

$$\text{Absolute Value } (D_1 - D_2) > 6$$

Table 1 Degradation Value "D"

$$D = \frac{(15-H)}{(15 + 1.75H)} \times 100$$

H	D	H	D	H	D	H	D	H	D
0.0	100	3.1	58	6.1	35	9.1	19	12.1	8
0.1	98	3.2	57	6.2	34	9.2	19	12.2	8
0.2	96	3.3	56	6.3	33	9.3	18	12.3	7
0.3	95	3.4	55	6.4	33	9.4	18	12.4	7
0.4	93	3.5	54	6.5	32	9.5	17	12.5	7
0.5	91	3.6	54	6.6	32	9.6	17	12.6	6
0.6	90	3.7	53	6.7	31	9.7	17	12.7	6
0.7	88	3.8	52	6.8	30	9.8	16	12.8	6
0.8	87	3.9	51	6.9	30	9.9	16	12.9	6
0.9	85	4.0	50	7.0	29	10.0	15	13.0	5
1.0	84								
1.1	82	4.1	49	7.1	29	10.1	15	13.1	5
1.2	81	4.2	48	7.2	28	10.2	15	13.2	5
1.3	79	4.3	48	7.3	28	10.3	14	13.3	4
1.4	78	4.4	47	7.4	27	10.4	14	13.4	4
1.5	77	4.5	46	7.5	27	10.5	13	13.5	4
1.6	75	4.6	45	7.6	26	10.6	13	13.6	4
1.7	74	4.7	44	7.7	26	10.7	13	13.7	3
1.8	73	4.8	44	7.8	25	10.8	12	13.8	3
1.9	71	4.9	43	7.9	25	10.9	12	13.9	3
2.0	70	5.0	42	8.0	24	11.0	12	14.0	3
2.1	69	5.1	41	8.1	24	11.1	11	14.1	2
2.2	68	5.2	41	8.2	23	11.2	11	14.2	2
2.3	67	5.3	40	8.3	23	11.3	11	14.3	2
2.4	66	5.4	39	8.4	22	11.4	10	14.4	1
2.5	65	5.5	39	8.5	22	11.5	10	14.5	1
2.6	63	5.6	38	8.6	21	11.6	10	14.6	1
2.7	62	5.7	37	8.7	21	11.7	9	14.7	1
2.8	61	5.8	37	8.8	20	11.8	9	14.8	0
2.9	60	5.9	36	8.9	20	11.9	9	14.9	0
3.0	59	6.0	35	9.0	20	12.0	8	15.0	0



## Performance Exam Checklist

### WSDOT TM 113

#### *Method of Test for Determination of Degradation Value*

Participant Name: \_\_\_\_\_ Exam Date: \_\_\_\_\_

Record the symbols "P" for passing or "F" for failing on each step of the checklist.

Procedure Element	Trial 1	Trial 2
<b>Equipment</b>		
1. Balance - 5000g capacity, sensitive to 0.1g- Calibrated?	_____	_____
2. Degradation Shaker - 1¾" throw, 300 ± 5 oscillations per minute - Verified?	_____	_____
3. Canister - plastic, 7½ in diameter x 6 in high, walls meet floor at 90 deg with min fillet, or steel meeting AASHTO T210, or ASTM D 3744?	_____	_____
4. Sand Equivalent Cylinder & Rubber Stopper?	_____	_____
5. Sand Equivalent Stock Solution?	_____	_____
6. Sieves - ½, ⅜, ¼, No. 10, No. 200 - Verified?	_____	_____
7. Graduates - 500 ml tall form & 100 ml?	_____	_____
8. Interval Timer - Verified?	_____	_____
9. Funnel - Large enough to hold the sieves with a mouth that fits in the 500 ml graduate?	_____	_____
10. Sieve Shaker(s) - Verified?	_____	_____
11. Oven - verified at 230 ± 9°F.- Calibrated?	_____	_____
12. Sprayer - produces a low volume stream of water?	_____	_____
13. Containers - suitable for drying and washing?	_____	_____
<b>Procedure</b>		
1. a. Pit Run - Dried and separated over the ½ in, ½-discarded?	_____	_____
b. Processed material - Dried?	_____	_____
c. Quarry material - prepared for crushing?	_____	_____
2. Material crushed to pass the ½"?	_____	_____
3. Split out approx. 5000g?	_____	_____
4. Separate the material over the ½, ⅜, ¼, and No. 10?	_____	_____
5. Split or quarter approx. 550g ½-⅜, 550g ⅜-¼, & 1100g ¼-No. 10?	_____	_____
6. Combine the ½-⅜ with the ⅜-¼?	_____	_____

Procedure Element	Trial 1	Trial 2
7. Hand wash the 1/2-1/4 and 1/4-No. 10 separately?	_____	_____
8. Dry the portions in suitable containers at 230 ± 9 to a constant weight?	_____	_____
9. Split of quarter the two sizes into two 500 ± 1g portions, hand selection ok to 50g?	_____	_____
10. Combine to create two 1000 ± 2g, 1/2 - No. 10 test samples?	_____	_____
11. Place one sample into a canister, cover with 200 ± 5 ml water, cover & shake for 20 min?	_____	_____
12. Empty canister into the nested No. 10 & No. 200 fitted in the funnel over the 500 ml grad.?	_____	_____
13. Rinse the lid into the canister and then the canister into the nested sieves?	_____	_____
14. Shake the sieves to spread the sample?	_____	_____
15. Wash using only 20-50 ml.?	_____	_____
16. Shake the sieves to release trapped water and then lift observing liquid for clarity?	_____	_____
17. Repeat 14-16 until water reaches the 500 ml mark - water not to exceed 500 ml?	_____	_____
18. No loss of fines or liquid during the washing process?	_____	_____
19. Place 7 ± 1 ml of SE Stock Solution in a SE Graduated Cylinder?	_____	_____
20. Turn capped 500 ml upside down & back allowing bubble to traverse 10 cycles?	_____	_____
21. Immediately pour into a SE Cylinder to the 15 ± 0.1 mark - no settling allowed?	_____	_____
22. Rubber stopper inserted and SE Cylinder turned upside down & back 20 cycles?	_____	_____
23. Place gently, remove stopper, start timer, allow to sit undisturbed for 20 min?	_____	_____
24. Record height of column to nearest 0.1 in?	_____	_____
25. Repeat for second sample?	_____	_____
26. Calculations performed correctly?	_____	_____
27. Second sample must be within 6 points?	_____	_____

Comments: First Attempt: Pass \_\_\_\_\_ Fail \_\_\_\_\_ Second Attempt: Pass \_\_\_\_\_ Fail \_\_\_\_\_

Examiner Signature: \_\_\_\_\_ WAQTC #: \_\_\_\_\_

## SLUMP OF HYDRAULIC CEMENT CONCRETE FOP FOR AASHTO T 119

### Scope

This procedure provides instructions for determining the slump of hydraulic cement concrete in accordance with AASHTO T 119-23. It is not applicable to non-plastic and non-cohesive concrete.

**Warning**—Fresh Hydraulic cementitious mixtures are caustic and may cause chemical burns to skin and tissue upon prolonged exposure.

### Apparatus

- Mold: conforming to AASHTO T 119
  - Metal: a metal frustum of a cone provided with foot pieces and handles. The mold must be constructed without a seam. The interior of the mold shall be relatively smooth and free from projections such as protruding rivets. The mold shall be free from dents, deformations, and adhered mortar. A mold that clamps to a rigid nonabsorbent base plate is acceptable provided the clamping arrangement is such that it can be fully released without movement of the mold.
  - Non-metal: see AASHTO T 119, Section 5.1.2.
- Tamping rod: 16 mm (5/8 in.) diameter and 400 mm (16 in.) to 600 mm (24 in.) long, having a hemispherical tip the same diameter as the rod. (Hemispherical means “half a sphere”; the tip is rounded like half of a ball.)
- Scoop: a receptacle of appropriate size so that each representative increment of the concrete sample can be placed in the container without spillage.
- Tape measure or ruler with at least 5 mm or 1/8 in. graduations
- Base: flat, rigid, non-absorbent moistened surface on which to set the slump mold

### Procedure

1. Obtain the sample in accordance with the FOP for WAQTC TM 2. If the concrete mixture contains aggregate retained on the 37.5mm (1½ in.) sieve, remove the aggregate by sieving the concrete sample over a 37.5 mm (1½ in.) sieve in accordance with the Wet Sieving portion of the FOP for WAQTC TM 2.  
Begin testing within five minutes of obtaining the sample.
2. Dampen the inside of the mold and place it on a dampened, rigid, nonabsorbent surface that is level and firm.
3. Stand on both foot pieces to hold the mold firmly in place.
4. Use the scoop to fill the mold 1/3 full by volume, to a depth of approximately 67 mm (2 5/8 in.).
5. Consolidate the layer with 25 strokes of the tamping rod, using the rounded end. Rod the bottom layer throughout its depth. Distribute the strokes evenly over the entire cross section of the concrete.

For the bottom layer, incline the rod slightly and make approximately half the strokes near the perimeter, and then progress with vertical strokes, spiraling toward the center.

6. Use the scoop to fill the mold  $\frac{2}{3}$  full by volume, to a depth of approximately 155 mm (6  $\frac{1}{8}$  in.).
7. Consolidate this layer with 25 strokes of the tamping rod, penetrate approximately 25 mm (1 in.) into the bottom layer. Distribute the strokes evenly.
8. Use the scoop to fill the mold to overflowing.
9. Consolidate this layer with 25 strokes of the tamping rod, penetrate approximately 25 mm (1 in.) into the second layer. Distribute the strokes evenly. If the concrete falls below the top of the mold, stop, add more concrete, and continue rodding for a total of 25 strokes. Always keep an excess of concrete above the top of the mold. Distribute strokes evenly.
10. Strike off the top surface of concrete with a screeding and rolling motion of the tamping rod.
11. Clean overflow concrete away from the base of the mold.
12. Remove the mold from the concrete by raising it carefully in a vertical direction. Raise the mold 300 mm (12 in.) in  $5 \pm 2$  seconds by a steady upward lift with no lateral or torsional (twisting) motion being imparted to the concrete.

Complete the entire operation from the start of the filling through removal of the mold without interruption within an elapsed time of 2  $\frac{1}{2}$  minutes.

13. Immediately measure the slump:
  - a. Invert the slump mold and set it next to the specimen.
  - b. Lay the tamping rod across the mold so that it is over the test specimen.
  - c. Measure the distance between the bottom of the rod and the displaced original center of the top of the specimen to the nearest 5 mm ( $\frac{1}{4}$  in.).
  - d. If a decided falling away or shearing off of concrete from one side or portion of the mass occurs, disregard the test and perform a new test on another portion of the sample.

*Note 1:* If two consecutive tests on a sample of concrete show a falling away or shearing off of a portion of the concrete from the mass of the specimen, the concrete probably lacks the plasticity and cohesiveness necessary for the slump test to be applicable.

14. Discard the tested sample.

## Report

- Results on forms approved by the agency
- Sample ID
- Slump to the nearest 5 mm ( $\frac{1}{4}$  in.).



**PERFORMANCE EXAM CHECKLIST**

**SLUMP OF HYDRAULIC CEMENT CONCRETE  
FOP FOR AASHTO T 119**

Participant Name \_\_\_\_\_ Exam Date \_\_\_\_\_

Record the symbols “P” for passing or “F” for failing on each step of the checklist.

<b>Procedure Element</b>	<b>Trial 1</b>	<b>Trial 2</b>
<b>First layer</b>		
1. Mold and floor or base plate dampened?	_____	_____
2. Mold held firmly against the base by standing on the two foot pieces? Mold not allowed to move in any way during filling?	_____	_____
3. Representative sample scooped into the mold?	_____	_____
4. Mold approximately one third (by volume), 67 mm (2 5/8 in.) deep?	_____	_____
5. Layer rodded throughout its depth 25 times with hemispherical end of rod, uniformly distributing strokes?	_____	_____
<b>Second layer</b>		
6. Representative samples scooped into the mold?	_____	_____
7. Mold filled approximately two thirds (by volume), 155 mm (6 1/8 in.), deep?	_____	_____
8. Layer rodded throughout its depth 25 times with hemispherical end of rod, uniformly distributing strokes, penetrate approximately 25 mm (1 in.) into the bottom layer?	_____	_____
<b>Third layer</b>		
9. Representative sample scooped into the mold?	_____	_____
10. Mold filled to just over the top of the mold?	_____	_____
11. Layer rodded throughout its depth 25 times with hemispherical end of rod, uniformly distributing strokes, penetrate approximately 25 mm (1 in.) into the second layer?	_____	_____
12. Excess concrete kept above the mold at all times while rodding?	_____	_____
13. Concrete struck off level with top of mold using tamping rod?	_____	_____

**OVER**

CONCRETE

WAQTC

FOP AASHTO T 119 (23)

**Procedure Element**

**Trial 1    Trial 2**

- 14. Concrete removed from around the outside bottom of the mold? \_\_\_\_\_
- 15. Mold lifted upward 300 mm (12 in.) in one smooth motion, without a lateral or twisting motion of the mold, in 5 ±2 seconds? \_\_\_\_\_
- 16. Test performed from start of filling through removal of the mold within 2 1/2 minutes? \_\_\_\_\_
- 17. Slump immediately measured to the nearest 5 mm (1/4 in.) from the top of the mold to the displaced original center of the top surface of the specimen? \_\_\_\_\_

Comments:      First attempt: Pass \_\_\_\_\_ Fail \_\_\_\_\_      Second attempt: Pass \_\_\_\_\_ Fail \_\_\_\_\_

---



---



---



---



---



---

Examiner Signature \_\_\_\_\_ WAQTC #: \_\_\_\_\_

This checklist is derived, in part, from copyrighted material printed in ACI CP-1, published by the American Concrete Institute.

## DENSITY (UNIT WEIGHT), YIELD, AND AIR CONTENT (GRAVIMETRIC) OF CONCRETE FOP FOR AASHTO T 121

### Scope

This method covers the determination of density, or unit weight, of freshly mixed concrete in accordance with AASHTO T 121-24. It also provides formulas for calculating the volume of concrete produced from a mixture of known quantities of component materials and provides a method for calculating cement content and cementitious material content – the mass of cement or cementitious material per unit volume of concrete. A procedure for calculating water/cement ratio is also covered.

**Warning**—Fresh Hydraulic cementitious mixtures are caustic and may cause chemical burns to skin and tissue upon prolonged exposure.

### Apparatus

- Measure: May be the bowl portion of the air meter used for determining air content under the FOP for AASHTO T 152. Otherwise, it shall be a cylindrical metal container meeting the requirements of AASHTO T 121. The capacity and dimensions of the measure shall conform to those specified in Table 1.
- Balance or scale: Accurate to within 45 g (0.1 lb) or 0.3 percent of the test load, whichever is greater, at any point within the range of use.
- Tamping rod: 16 mm (5/8 in.) diameter and 400 mm (16 in.) to 600 mm (24 in.) long, having a hemispherical tip the same diameter as the rod. (Hemispherical means “half a sphere”; the tip is rounded like half of a ball.)
- Vibrator: frequency at least 9000 vibrations per minute (150 Hz), at least 19 to 38 mm (3/4 to 1 1/2 in.) in diameter but not greater than 38 mm (1 1/2 in.), and the length of the shaft shall be at least 75 mm (3 in.) longer than the depth of the section being vibrated.
- Scoop: a receptacle of appropriate size so that each representative increment of the concrete sample can be placed in the container without spillage.
- Strike-off plate: A flat rectangular metal plate at least 6 mm (1/4 in.) thick or a glass or acrylic plate at least 12 mm (1/2 in.) thick, with a length and width at least 50 mm (2 in.) greater than the diameter of the measure with which it is to be used. The edges of the plate shall be straight and smooth within tolerance of 1.5 mm (1/16 in.).
- Mallet: With a rubber or rawhide head having a mass of  $0.57 \pm 0.23$  kg ( $1.25 \pm 0.5$  lb) for use with measures of 14 L ( $1/2$  ft<sup>3</sup>) or less or having a mass of  $1.02 \pm 0.23$  kg ( $2.25 \pm 0.5$  lb) for use with measures larger than 14 L ( $1/2$  ft<sup>3</sup>).

**Table 1**  
**Dimensions of Measures\***

Capacity m <sup>3</sup> (ft <sup>3</sup> )	Inside Diameter mm (in.)	Inside Height mm (in.)	Minimum Thicknesses mm (in.)		Nominal Maximum Size of Coarse Aggregate*** mm (in.)
			Bottom	Wall	
0.0071	203 ±2.54	213 ±2.54	5.1	3.0	25
(1/4)**	(8.0 ±0.1)	(8.4 ±0.1)	(0.20)	(0.12)	(1)
0.0142	254 ±2.54	279 ±2.54	5.1	3.0	50
(1/2)	(10.0 ±0.1)	(11.0 ±0.1)	(0.20)	(0.12)	(2)

\* **Note 1:** The indicated size of measure shall be for aggregates of nominal maximum size equal to or smaller than that listed.

\*\* Measure may be the base of the air meter used in the FOP for AASHTO T 152.

\*\*\* Nominal maximum size: One sieve larger than the first sieve to retain more than 10 percent of the material using an agency specified set of sieves based on cumulative percent retained. Where large gaps in specification sieves exist, intermediate sieve(s) may be inserted to determine nominal maximum size.

## Consolidation Selection

There are two methods of consolidating the concrete – rodding and vibration. If the slump is greater than 75 mm (3 in.), consolidation is by rodding. When the slump is 25 to 75 mm (1 to 3 in.), internal vibration or rodding can be used to consolidate the sample, but the method used must be that required by the agency to obtain consistent, comparable results. For concrete with slump less than 25 mm (1 in.), consolidate the sample by internal vibration. Do not consolidate self-consolidating concrete (SCC).

When using measures greater than 0.0142 m<sup>3</sup> (1/2 ft<sup>3</sup>), see AASHTO T 121.

## Procedure

### Sampling

1. Obtain the sample in accordance with the FOP for WAQTC TM 2. Testing may be performed in conjunction with the FOP for AASHTO T 152. When doing so, this FOP should be performed before the FOP for AASHTO T 152.

**Note 2:** If the two tests are being performed using the same sample, this test shall begin within five minutes of obtaining the sample.

### Rodding

1. Dampen the inside of the measure and empty excess water.
2. Determine and record the mass of the measure.
3. Use the scoop to fill the measure approximately 1/3 full with concrete. Evenly distribute the concrete in a circular motion around the inner perimeter of the measure.

4. Consolidate the layer with 25 strokes of the tamping rod, using the rounded end. Distribute the strokes evenly over the entire cross section of the concrete. Rod throughout its depth without hitting the bottom too hard.
5. Tap around the perimeter of the measure smartly 10 to 15 times with the mallet to close voids and release trapped air.
6. Add the second layer, filling the measure about 2/3 full. Evenly distribute the concrete in a circular motion around the inner perimeter of the measure.
7. Consolidate this layer with 25 strokes of the tamping rod, penetrating about 25 mm (1 in.) into the bottom layer.
8. Tap around the perimeter of the measure smartly 10 to 15 times with the mallet.
9. Add the final layer, slightly overfilling the measure. Evenly distribute the concrete in a circular motion around the inner perimeter of the measure.
10. Consolidate this layer with 25 strokes of the tamping rod, penetrating about 25 mm (1 in.) into the second layer.
11. Tap around the perimeter of the measure smartly 10 to 15 times with the mallet.
12. Continue with ‘Strike-off and Determining Mass.’

#### **Internal Vibration**

1. Dampen the inside of the measure and empty excess water.
2. Determine and record the mass of the measure.
3. Use the scoop to fill the measure approximately 1/2 full with concrete. Evenly distribute the concrete in a circular motion around the inner perimeter of the measure.
4. Insert the vibrator at three different points in each layer. Do not let the vibrator touch the bottom or side of the measure. Continue vibration only long enough to achieve proper consolidation of the concrete. Over vibration may cause segregation and loss of appreciable quantities of intentionally entrained air.
5. Slightly overfill the measure. Evenly distribute the concrete in a circular motion around the inner perimeter of the measure.
6. Insert the vibrator at three different points, penetrating the first layer approximately 25 mm (1 in.). Do not let the vibrator touch the side of the measure.
7. Continue with ‘Strike-off and Determining Mass.’

#### **Self-Consolidating Concrete**

1. Dampen the inside of the measure and empty excess water.
2. Determine and record the mass of the measure.
3. Use the scoop to slightly overfill the measure. Do not exceed 125 mm (5 in.) drop height. Evenly distribute the concrete in a circular motion around the inner perimeter of the measure.
4. Continue with ‘Strike-off and Determining Mass.’

**Strike-off and Determining Mass**

1. After consolidation, the measure should be slightly over full, about 3 mm (1/8 in.) above the rim. If there is a great excess of concrete, remove a portion with the scoop. If the measure is under full, add a small quantity. This adjustment may be done only after consolidating the final layer and before striking off the surface of the concrete.
2. Press the strike-off plate flat against the top surface, covering approximately 2/3 of the measure.
3. Withdraw the strike-off plate with a sawing motion to finish the 2/3 originally covered.
4. Cover the original 2/3 again with the plate; finishing the remaining 1/3 with a sawing motion (do not lift the plate; continue the sawing motion until the plate has cleared the surface of the measure).
5. Finish the surface with the inclined edge of the strike-off plate. The surface should be smooth and free of voids.
6. Clean off all excess concrete from the exterior of the measure including the rim.
7. Determine and record the mass of the measure and the concrete.
8. If the air content of the concrete is to be determined, ensure the rim (flange) is clean and proceed to 'Strike-off and Air Content' Step 3 of the FOP for AASHTO T 152.

## Calculations

### Mass of concrete in the measure

$$\text{concrete mass} = M_c - M_m$$

Where:

Concrete mass = mass of concrete in measure

$M_c$  = mass of measure and concrete

$M_m$  = mass of measure

### Density

$$\rho = \frac{\text{concrete mass}}{V_m}$$

Where:

$\rho$  = density of the concrete mix

$V_m$  = volume of measure (Annex)

### Yield $m^3$

$$Y_{m^3} = \frac{W}{\rho}$$

Where:

$Y_{m^3}$  = yield ( $m^3$  of the batch of concrete)

$W$  = total mass of the batch of concrete

**Yield yd<sup>3</sup>**

$$Y_{ft^3} = \frac{W}{\rho} \qquad Y_{yd^3} = \frac{Y_{ft^3}}{27ft^3/yd^3}$$

Where:

$Y_{ft^3}$	=	yield (ft <sup>3</sup> of the batch of concrete)
$Y_{yd^3}$	=	yield (yd <sup>3</sup> of the batch of concrete)
$W$	=	total mass of the batch of concrete
$\rho$	=	density of the concrete mix

**Note 5:** The total mass, W, includes the masses of the cement, water, and aggregates in the concrete.

**Cement Content**

$$N = \frac{N_t}{Y}$$

Where:

$N$	=	actual cementitious material content per $Y_m^3$ or $Y_{yd^3}$
$N_t$	=	mass of cementitious material in the batch
$Y$	=	$Y_m^3$ or $Y_{yd^3}$

**Note 6:** Specifications may require Portland Cement content and supplementary cementitious materials content.

**Water Content**

The mass of water in a batch of concrete is the sum of:

- water added at batch plant
- water added in transit
- water added at jobsite
- free water on coarse aggregate\*
- free water on fine aggregate\*
- liquid admixtures (if required by the agency)

\*Mass of free water on aggregate

This information is obtained from concrete batch tickets collected from the driver. Use the Table 2 to convert liquid measures.



**Table 2**  
**Liquid Conversion Factors**

To Convert From	To	Multiply By
Liters, L	Kilograms, kg	1.0
Gallons, gal	Kilograms, kg	3.785
Gallons, gal	Pounds, lb	8.34
Milliliters, mL	Kilograms, kg	0.001
Ounces, oz	Milliliters, mL	28.4
Ounces, oz	Kilograms, kg	0.0284
Ounces, oz	Pounds, lb	0.0625
Pounds, lb	Kilograms, kg	0.4536

### Mass of free water on aggregate

$$\text{Free Water Mass} = \text{CA or FC Aggregate} - \frac{\text{CA or FC Aggregate}}{1 + (\text{Free Water Percentage}/100)}$$

Where:

- Free Water Mass = on coarse or fine aggregate  
 FC or CA Aggregate = mass of coarse or fine aggregate  
 Free Water Percentage = percent of moisture of coarse or fine aggregate

### Water/Cement Ratio

$$\frac{\text{Water Content}}{C}$$

Where:

- Water Content = total mass of water in the batch  
 C = total mass of cementitious materials

CONCRETE

WAQTC

FOP AASHTO T 121 (24)

**Example**

Mass of concrete in measure ( $M_m$ )	16.290 kg (36.06 lb)
Volume of measure ( $V_m$ )	0.007079 m <sup>3</sup> (0.2494 ft <sup>3</sup> )

From batch ticket:

Yards batched	4 yd <sup>3</sup>
Cement	950 kg (2094 lb)
Fly ash	180 kg (397 lb)
Coarse aggregate	3313 kg (7305 lb)
Fine aggregate	2339 kg (5156 lb)
Water added at plant	295 L (78 gal)

Other

Water added in transit	0
Water added at jobsite	38 L (10 gal)
Total mass of the batch of concrete (W)	7115 kg (15,686 lb)
Moisture content of coarse aggregate	1.7%
Moisture content of coarse aggregate	5.9%

CONCRETE

WAQTC

FOP AASHTO T 121 (24)

**Density**

$$\rho = \frac{\text{concrete mass}}{V_m}$$

$$\rho = \frac{16.920 \text{ kg}}{0.007079 \text{ m}^3} = 2390 \text{ kg/m}^3 \quad \rho = \frac{36.06 \text{ lb}}{0.2494 \text{ ft}^3} = 144.6 \text{ lb/ft}^3$$

Given:

$$\text{concrete mass} = 16.920 \text{ kg (36.06 lb)}$$

$$V_m = 0.007079 \text{ m}^3 (0.2494 \text{ ft}^3) \text{ (Annex)}$$

**Yield m<sup>3</sup>**

$$Y_{m^3} = \frac{W}{\rho}$$

$$Y_{m^3} = \frac{7115 \text{ kg}}{2390 \text{ kg/m}^3} = 2.98 \text{ m}^3$$

Given:

$$\text{Total mass of the batch of concrete (W), kg} = 7115 \text{ kg}$$

CONCRETE

WAQTC

FOP AASHTO T 121 (24)

**Yield  $yd^3$** 

$$Y_{ft^3} = \frac{W}{\rho}$$

$$Y_{yd^3} = \frac{Y_{ft^3}}{27 ft^3/yd^3}$$

$$Y_{ft^3} = \frac{15,686 lb}{144.6 lb/ft^3} = 108.48 ft^3 \quad Y_{yd^3} = \frac{108.48 ft^3}{27 ft^3/yd^3} = 4.02 yd^3$$

Given:

Total mass of the batch of concrete (W), lb = 15,686 lb

**Cement Content**

$$N = \frac{N_t}{Y}$$

$$N = \frac{950 kg + 180 kg}{2.98 m^3} = 379 kg/m^3 \quad N = \frac{2094 lb + 397 lb}{4.02 yd^3} = 620 lb/yd^3$$

Given:

N<sub>t</sub> (cement) = 950 kg (2094 lb)N<sub>t</sub> (flyash) = 180 kg (397 lb)Y = Y<sub>m</sub><sup>3</sup> or Y<sub>yd</sub><sup>3</sup>**Note 6:** Specifications may require Portland Cement content and supplementary cementitious materials content.

CONCRETE

WAQTC

FOP AASHTO T 121 (24)

**Free water**

$$\text{Free Water Mass} = \text{CA or FC Aggregate} - \frac{\text{CA or FC Aggregate}}{1 + (\text{Free Water Percentage}/100)}$$

$$\text{CA Free Water} = 3313 \text{ kg} - \frac{3313 \text{ kg}}{1 + (1.7/100)} = 55 \text{ kg}$$

$$\text{CA Free Water} = 7305 \text{ lb} - \frac{7305 \text{ lb}}{1 + (1.7/100)} = 122 \text{ lb}$$

$$\text{FA Free Water} = 2339 \text{ kg} - \frac{2339 \text{ kg}}{1 + (5.9/100)} = 130 \text{ kg}$$

$$\text{FA Free Water} = 5156 \text{ lb} - \frac{5156 \text{ lb}}{1 + (5.9/100)} = 287 \text{ lb}$$

Given:

CA aggregate = 3313 kg (7305 lb)

FC aggregate = 2339 kg (5156 lb)

CA moisture content = 1.7%

FC moisture content = 5.9%

CONCRETE

WAQTC

FOP AASHTO T 121 (24)

**Water Content**

Total of all water in the mix.

$$\text{Water Content} = [(78 \text{ gal} + 10 \text{ gal}) * 3.785 \text{ kg/gal}] + 55 \text{ kg} + 130 \text{ kg} = 518 \text{ kg}$$

$$\text{Water Content} = [(78 \text{ gal} + 10 \text{ gal}) * 8.34 \text{ lb/gal}] + 122 \text{ lb} + 287 \text{ lb} = 1143 \text{ lb}$$

Given:

$$\text{Water added at plant} = 295 \text{ L (78 gal)}$$

$$\text{Water added at the jobsite} = 38 \text{ L (10 gal)}$$

**Water/ Cement Ratio**

$$W/C = \frac{518 \text{ kg}}{950 \text{ kg} + 180 \text{ kg}} = 0.458 \quad W/C = \frac{1143 \text{ lb}}{2094 \text{ lb} + 397 \text{ lb}} = 0.459$$

**Report 0.46****Report**

- Results on forms approved by the agency
- Sample ID
- Density (unit weight) to the nearest 1 kg/m<sup>3</sup> (0.1 lb/ft<sup>3</sup>)
- Yield to the nearest 0.01 m<sup>3</sup> (0.01 yd<sup>3</sup>)
- Cement content to the nearest 1 kg/m<sup>3</sup> (1 lb/yd<sup>3</sup>)
- Cementitious material content to the nearest 1 kg/m<sup>3</sup> (1 lb/yd<sup>3</sup>)
- Water/Cement ratio to the nearest 0.01

---

## ANNEX – STANDARDIZATION OF MEASURE

(Mandatory Information)

Standardization is a critical step to ensure accurate test results when using this apparatus. Failure to perform the standardization procedures as described herein will produce inaccurate or unreliable test results.

### Apparatus

- Listed in the FOP for AASHTO T 121
  - Measure
  - Balance or scale
  - Strike-off plate
- Thermometer: Standardized liquid-in-glass, or electronic digital total immersion type, accurate to 0.5°C (1°F)

### Procedure

1. Determine the mass of the dry measure and strike-off plate.
2. Fill the measure with water at a temperature between 16°C and 29°C (60°F and 85°F) and cover with the strike-off plate in such a way as to eliminate bubbles and excess water.
3. Wipe the outside of the measure and cover plate dry, being careful not to lose any water from the measure.
4. Determine the mass of the measure, strike-off plate, and water in the measure.
5. Determine the mass of the water in the measure by subtracting the mass in Step 1 from the mass in Step 4.
6. Measure the temperature of the water and determine its density from Table A1, interpolating as necessary.
7. Calculate the volume of the measure,  $V_m$ , by dividing the mass of the water in the measure by the density of the water at the measured temperature.

**Calculations**

$$V_m = \frac{M}{\rho_w}$$

Where:

$V_m$  = volume of the mold

$M$  = mass of water in the mold

$\rho_w$  = density of water at the measured temperature

**Example**

Mass of water in Measure = 7.062 kg (15.53 lb)

Density of water at 23°C (73.4°F) ( $\rho_w$ ) = 997.54 kg/m<sup>3</sup> (62.274 lb/ft<sup>3</sup>)

$$V_m = \frac{7.062 \text{ kg}}{997.54 \text{ kg/m}^3} = 0.007079 \text{ m}^3 \quad V_m = \frac{15.53 \text{ lb}}{62.274 \text{ lb/ft}^3} = 0.2494 \text{ ft}^3$$



CONCRETE

WAQTC

FOP AASHTO T 121 (24)

**Table A1**  
**Unit Mass of Water**  
**15°C to 30°C**

°C	(°F)	kg/m <sup>3</sup>	(lb/ft <sup>3</sup> )	°C	(°F)	kg/m <sup>3</sup>	(lb/ft <sup>3</sup> )
15	(59.0)	999.10	(62.372)	23	(73.4)	997.54	(62.274)
15.6	(60.0)	999.01	(62.366)	23.9	(75.0)	997.32	(62.261)
16	(60.8)	998.94	(62.361)	24	(75.2)	997.29	(62.259)
17	(62.6)	998.77	(62.350)	25	(77.0)	997.03	(62.243)
18	(64.4)	998.60	(62.340)	26	(78.8)	996.77	(62.227)
18.3	(65.0)	998.54	(62.336)	26.7	(80.0)	996.59	(62.216)
19	(66.2)	998.40	(62.328)	27	(80.6)	996.50	(62.209)
20	(68.0)	998.20	(62.315)	28	(82.4)	996.23	(62.192)
21	(69.8)	997.99	(62.302)	29	(84.2)	995.95	(62.175)
21.1	(70.0)	997.97	(62.301)	29.4	(85.0)	995.83	(62.166)
22	(71.6)	997.77	(62.288)	30	(86.0)	995.65	(62.156)

### Report

- Measure ID
- Date Standardized
- Temperature of the water
- Volume,  $V_m$ , of the measure

CONCRETE

WAQTC

FOP AASHTO T 121 (24)

**PERFORMANCE EXAM CHECKLIST**

**DENSITY (UNIT WEIGHT), YIELD, AND AIR CONTENT (GRAVIMETRIC) OF CONCRETE FOP FOR AASHTO T 121**

Participant Name \_\_\_\_\_ Exam Date \_\_\_\_\_

Record the symbols "P" for passing or "F" for failing on each step of the checklist.

<b>Procedure Element</b>	<b>Trial 1</b>	<b>Trial 2</b>
1. Mass of dampened measure determined?	_____	_____
<b>First Layer</b>		
2. Measure filled approximately one third full, moving a scoop around the perimeter of the measure to evenly distribute the concrete as discharged?	_____	_____
3. Layer rodded throughout its depth 25 times, without forcibly striking the bottom of the measure, with hemispherical end of rod, uniformly distributing strokes?	_____	_____
4. Perimeter of the measure tapped 10 to 15 times with the mallet after rodding?	_____	_____
<b>Second layer</b>		
5. Measure filled approximately two thirds full, moving a scoop around the perimeter of the measure to evenly distribute the concrete as discharged?	_____	_____
6. Layer rodded throughout its depth, just penetrating the previous layer (approximately 25 mm (1 in.) 25 times with hemispherical end of rod, uniformly distributing strokes?	_____	_____
7. Perimeter of the measure tapped 10 to 15 times with the mallet after rodding?	_____	_____
<b>Third layer</b>		
8. Measure slightly overfilled, moving a scoop around the perimeter of the measure to evenly distribute the concrete as discharged?	_____	_____
9. Layer rodded throughout its depth, just penetrating the previous layer (approximately 25 mm (1 in.) 25 times with hemispherical end of rod, uniformly distributing strokes?	_____	_____
10. Perimeter of the measure tapped 10 to 15 times with the mallet after rodding each layer?	_____	_____
11. Any excess concrete removed using a trowel or a scoop, or small quantity of concrete added to correct a deficiency, after consolidation of final layer?	_____	_____

**OVER**

**Procedure Element**

**Trial 1 Trial 2**

- 12. Strike-off plate placed flat on the measure covering approximately 2/3 of the surface, then sawing action used to withdraw the strike-off plate across the previously covered surface? \_\_\_\_\_ \_\_\_\_\_
- 13. Strike-off plate placed flat on the measure covering approximately 2/3 of the surface, then sawing action used to advance the plate across the entire measure surface? \_\_\_\_\_ \_\_\_\_\_
- 14. Strike off completed using the inclined edge of the plate creating a smooth surface? \_\_\_\_\_ \_\_\_\_\_
- 15. All excess concrete cleaned off and mass of full measure determined? \_\_\_\_\_ \_\_\_\_\_
- 16. Concrete mass calculated? \_\_\_\_\_ \_\_\_\_\_
- 17. Density calculated correctly? \_\_\_\_\_ \_\_\_\_\_

**Comments:** First attempt: Pass \_\_\_\_\_ Fail \_\_\_\_\_ Second attempt: Pass \_\_\_\_\_ Fail \_\_\_\_\_

\_\_\_\_\_

\_\_\_\_\_

\_\_\_\_\_

\_\_\_\_\_

Examiner Signature \_\_\_\_\_ WAQTC #: \_\_\_\_\_

This checklist is derived, in part, from copyrighted material printed in ACI CP-1, published by the American Concrete Institute.



## WSDOT Test Method T 123

### *Method of Test for Bark Mulch*

#### 1. Scope

- a. This method covers a procedure for determining the sieve analysis and material finer than No. 4 sieve using a loose volume bucket.

#### 2. Equipment

- a. A mechanical sieve shaker.
- b. Sieves – Sieves conforming to the requirements of ASTM E11. Breaker sieves may be used.
- c. Volume Bucket – A container calibrated in 1 gal. increments from 1 to 5 gal. A 5-gal. bucket may be used when calibrated as follows:

On a level surface calibrate the container by gradually filling it with water in 1 gal. increments. Mark the inner wall of the container after the addition of each gallon

#### 3. Procedure

- a. Air dry (140°F max) the sample for 15 hours, ± 4 hours.
- b. Reduce the sample to testing size per the FOP for AASHTO R 76.
- c. Place the sample in the volume bucket and record the volume as the total volume.
- d. Shake the sample over the 2 in and No. 4 sieves. Using breaker sieves inserted between the two specified sieves so the No. 4 sieve will not be **overloaded**. Use caution to avoid over sieving as the wood material breaks down.
- e. The material retained on the 2 in sieve is measured in the volume bucket and recorded.
- f. The material on the breaker sieves is added to the material retained on the No. 4 sieve and the volume measured in the volume bucket and recorded.
- g. The percent passing is calculated as follows:

$$100 - \frac{(\text{Volume on sieve} \times 100)}{\text{Total Volume}} = \% \text{ passing}$$



# Performance Exam Checklist

## WSDOT T 123

### Method of Test for Bark Mulch

Participant Name: \_\_\_\_\_ Exam Date: \_\_\_\_\_

Record the symbols "P" for passing or "F" for failing on each step of the checklist.

Procedure Element	Trial 1	Trial 2
1. The tester has a copy of the current procedure on hand?	_____	_____
2. All equipment is functioning according to the test procedure, and if required, has the current calibration/verification tags present?	_____	_____
3. Bark mulch sample air dried for 15 ± 4 hrs (@ 140°F max)?	_____	_____
4. Five (5) gallon bucket calibrated in 1 gal. increments?	_____	_____
5. Sample reduced according to FOP for AASHTO R 76 and placed in calibrated bucket?	_____	_____
6. Volume of sample in bucket recorded as total volume?	_____	_____
7. Sample screened in the shaker through 2 in screen, breaker screens and No. 4 screen?	_____	_____
8. Do not over shake to prevent degrading of sample?	_____	_____
9. Remove 2 in screen and damp material in calibrated bucket and record volume as volume on 2 in screen?	_____	_____
10. Place all breaker screen material down to No. 4 screen in bucket and record volume as volume on No. 4 screen?	_____	_____
11. All calculations performed correctly?	_____	_____
12. Report results?	_____	_____

Comments: First Attempt: Pass \_\_\_\_\_ Fail \_\_\_\_\_ Second Attempt: Pass \_\_\_\_\_ Fail \_\_\_\_\_

Examiner Signature: \_\_\_\_\_ WAQTC #: \_\_\_\_\_





## **WSDOT Test Method T 125**

### ***Determination of Fiber Length Percentages in Wood Strand Mulch***

#### **1. Scope**

- 1.1. This test method covers the determination of the percentage, by mass, of fiber strands in a wood strand mulch sample meeting the specified requirements.
- 1.2. This standard may involve hazardous materials, operations, and equipment. This standard does not purport to address all of the safety problems associated with its use. It is the responsibility of the user of this standard to establish appropriate safety and health practices and determine the applicability of regulatory limitations prior to use.

#### **2. Referenced Documents**

- 2.1. AASHTO Standards:
  - M 231      Weighing Devices Used in the Testing of Materials
  - R 76        Reducing Samples of Aggregate to Testing Size

#### **3. Summary of Test Method**

- 3.1. A sample of wood strand mulch is separated into individual fiber strands and the length, width and thickness of each strand is measured. The fiber strands are then separated into two categories; Strands meeting specified requirements and Strands not meeting specified requirements. The percentage of wood fiber strand is then computed and compared to the requirements of the specification. (See Calculation below)

#### **4. Apparatus**

- 4.1. *Balance* – shall have sufficient capacity, be readable to 0.1 percent of the sample mass, or better, and conform to the requirements of AASHTO M 231 for general-purpose balance required for the principle sample mass being tested.
- 4.2. *Measuring device* – capable of reading to the nearest  $\frac{1}{16}$ th inch (can either be one device or two separate devices)

## 5. Sampling

- 5.1 Split a bale of wood strand mulch into three approximately equal sections. From the interior face of each section obtain a minimum of 150 g of fiber strand, taking care not to damage the material.
- 5.2 Recombine the three 150 g samples and reduce the combined sample to a minimum sample size of 100g, in accordance with FOP for AASHTO R 76, Method B Quartering.

## 6. Sample Preparation

- 6.1. Air dry the sample to a Constant Mass as defined in AASHTO T 265.

## 7. Procedure

- 7.1. Spread the sample on a clean flat surface large enough to permit careful inspection of each strand. Measure the length, width and thickness of each strand in the 100g sample.
- 7.2. Compare the measurements of each strand to the specified requirements and separate the strands into two categories:
  - Strands meeting specified requirements
  - Strands not meeting specified requirements
- 7.3. Determine the total mass of each category.

## 8. Calculation

- 8.1. Report the following information:
  - 8.1.1. Calculate the percentage of fiber strand meeting the specified requirements to the nearest one percent as follows:

$$P = [(S) / (S+N)] \times 100$$

Where:

- P = percent of strands meeting the required specifications
- S = mass of strands meeting required specifications
- N = mass of strands not meeting required specifications

### Performance Exam Checklist

#### WSDOT Test Method 125

Participant Name: \_\_\_\_\_ Exam Date: \_\_\_\_\_

Record the symbols "P" for passing or "F" for failing on each step of the checklist.

Procedure Element	Trial 1	Trial 2
1. The tester has a copy of the current procedure on hand?	_____	_____
2. All equipment is functioning according to the test procedure, and if required, has the current calibration/verification tags present?	_____	_____
3. Sample reduced to correct size?	_____	_____
4. Sample dried and cooled, if necessary?	_____	_____
5. Sample properly measured?	_____	_____
6. Strands separated into "meeting specification" and "not meeting specifications" categories?	_____	_____
7. Dry mass of each category determined to nearest 0.1 g?	_____	_____
8. Calculation performed correctly?	_____	_____

Comments: First Attempt: Pass \_\_\_\_\_ Fail \_\_\_\_\_ Second Attempt: Pass \_\_\_\_\_ Fail \_\_\_\_\_

Examiner Signature: \_\_\_\_\_ WAQTC #: \_\_\_\_\_





---

## WSDOT Test Method T 126

### *Determination of Fiber Length Percentages in Hydraulically-Applied Erosion Control Products*

#### 1. Scope

- 1.1 This method covers the procedure for measuring the fiber length of a Hydraulically-applied Erosion Control Product (HECP).
- 1.2 HECP is engineered and processed to specific length and width dimensions to facilitate the hydraulic application process. When the correct percentages of fiber lengths and widths exist within the HECP for hydraulic planting, the result will be a properly layered, interlocking mulch to hold seed and moisture.
- 1.3 This standard does not purport to address the safety problems associated with its use. It is the responsibility of the user of this standard to establish appropriate safety and health practices and determine the applicability of regulatory limitations prior to use. (**Warning-** HECP's may be dusty, a dust mask is recommended when working with these products.)

#### 2. Terminology

- 2.1 Hydraulically applied - applied within a slurry, solution, or emulsion to the soil surface as a spray-on or dropped-on application through various means (e.g. nozzle, tower, aerially, etc.) formation of a compound by the combining of water with some other substance.
- 2.2 Hydraulically-applied Erosion Control Product (HECP) - A manufactured, degradable, pre-packaged fibrous material that is mixed with water and hydraulically applied as slurry, solution, or emulsion to reduce soil erosion and assist in the establishment and growth of vegetation.

#### 3. Apparatus

- 3.1 Balance – shall have sufficient capacity, readable to 0.1 percent of the sample mass, or better, and conform to the requirements of AASHTO M 231 for general-purpose balance required for the principle sample mass being tested.
- 3.2 Sieves – Meeting the requirements of ASTM E11
- 3.3 Mechanical sieve shaker – Meeting the requirements of AASHTO T 27

#### 4. Sample Preparation

Obtain approximate 60 grams of material from a full, sealed bag or bale in the following manner:

Divide the bag or bale into thirds; top, middle and bottom of bag or bale.

Extract approximately 20 grams of material from the center of each portion (or the inside face of each  $\frac{1}{3}$  of a bale) taking care not to damage the extracted material.

Recombine the three samples and reduce the sample, in accordance with AASHTO 248 Method B, to approximately 15 grams. Place the sample in a large container and gently separate the compressed fiber.

## 5. Procedure

- 5.1 Select sieves with suitable openings to furnish data required by the specifications. Nest the sieves in order of decreasing size from top to bottom and place the sample, or a portion of the sample, on the top sieve.
- 5.2 Place sieves in mechanical shaker and shake for a 5 minutes.
- 5.3 Determine the individual or cumulative mass retained on each sieve and the pan to the nearest 0.1g

## 6. Calculations

Calculate the percentage of fiber retained on each of the sieves using the following formula:

Percent Retained:

$$CPR = \frac{CMR}{M} \times 100$$

Where:

CPR = Cumulative Percent Retained

CMR= Cumulative Mass Retained

M = Total Sample mass

## 7. Report

Results shall be reported as follows:

- Cumulative mass retained on each sieve
- Cumulative percent retained on each sieve
- Percent passing and retained on each sieve shall be reported to the nearest 1 percent



## WSDOT Test Method T 127

### *Preparation of Leachate Sample for Testing Toxicity of HECP Effluents*

#### 1. Scope

This test method outlines the procedure for collecting leachate from a HECP sample.

#### 2. References

2.1 EPA-821-R-02-012 Methods for Measuring Acute Toxicity of Effluents

#### 3. Preparation of the HECP Sample

3.1 Lay cheesecloth over clean topsoil

3.2 Apply the HECP to the cheesecloth at the following coverage:

3.2.1 HECP Long-Term or Moderate-Term Mulch 3,500 lbs per acre in two lifts with no more than 2000# per acre in any one lift.

3.2.2 HECP Short-Term Mulch 2000# per acre minimum, or manufacturer's recommended rate may be used.

3.3 Allow material to cure for 48 hours

3.4 Pull cheesecloth up with mat of HECP, brush off any soil

3.5 Cut HECP into squares and provide 1.02 pounds of HECP to the laboratory.

#### 4. Preparation of the Leachate (done by the laboratory)

4.1 Allow hydromulch product to soak in water for one hour

4.2 Remove hydromulch sheet from water

4.3 Filter water through a 60 micron filter – water may be pre-filtered through a 35 mesh and then a 120 mesh before using the 230 mesh/63 micron filter.

**Note:** Leachate not immediately used for testing should be stored at 4° C in the dark until use.

4.4 Test leachate according to EPA-821-R-02-012 Methods for Measuring Acute Toxicity of Effluents.





## **WSDOT SOP 128**

### ***Sampling for Aggregate Source Approval***

#### **1. Scope**

This method describes the procedure for sampling pits and quarries for Aggregate Source Approval (ASA).

#### **2. Significance and Use**

There are two methods for initiating the process for an ASA:

- a. The source owner/lessee request approval, pays for the sampling and testing, and coordinates this through the ASA Engineer at the State Materials Laboratory who coordinates with the Regions. Sample is obtained by the Region Independent Assurance Inspector (IAI) or a delegate of the Region Materials Engineer (RME).
- b. The aggregate source is sampled and tested as part of a WSDOT project, in which case the WSDOT project pays for the sampling and testing costs which may or may not be coordinated with the ASA process at the State Materials Laboratory. Sample is obtained by the IAI or a delegate of the RME.

#### **3. Safety**

All WSDOT employee required to sample from a pit or quarry will contact the pit/quarry owner/lessee or their designated representative prior to arrival at the site and arrange for an escort into the sampling site.

All WSDOT employees will be accompanied by the pit/quarry owner/lessee or their representative during the sampling process.

This standard does not purport to address all of the safety concerns, associated with its use. It is the responsibility of the user of this standard operating procedure to establish a pre-activity safety plan prior to use.

#### **4. Sampling**

All samples will be obtained in accordance with WSDOT Errata to FOP for AASHTO R 90.

Stockpiles produced for ASA sampling must contain a minimum of 10 tons of material. The material in the stockpile shall be of the same quality as the final product. If the correct stockpiles are not available for sampling, the inspector will not take a sample and the sampling time will not be refunded.

Sampling location and size of sample is listed in Table 1.

**Table 1**

Aggregate Type	Sampling Site	Size of Sample in lbs	Notes
Concrete Coarse	Stockpile	50-100	Material must be clean and washed
Concrete Fine	Stockpile	30-40	Material must be clean and washed
Mineral Aggregate (WSDOT Standard Specification 9-03)	Stockpile	80-100	Material must be Crushed Surfacing Base Course - Std. Spec. 9-03.9(3). Samples obtained for quarry spalls may not be used for quality tests for crushed materials.
Quarry Spalls	Face of pit, transport unit or stockpile	50-80	No rock larger than 4" in diameter.
All other Aggregate Types	Face of pit, transport unit or stockpile	50-80	No rock larger than 4" in diameter.

## 6. Report

The RMEs representative will record the following information in an Inspector's Daily Report (IDR) DOT Form 422-004A:

- Name of Source owner/lessee's Representative accompanying the RME representative during sampling process.
- Time and Date of sampling
- Location including coordinates where the sample is taken (stockpile/pit/face)
- Amount of sample (pounds and number of bags)
- Any concerns of material quality or specific request the owner/lessee's representative may have.

The RME's representative shall take pictures of the following items; a wide view of the mining operation, the sampling location in the pit or quarry, a close-up of the stockpile being sampled and a close-up of the sampled material.

When Sampling is being performed by any group other than WSDOT personnel, sampling shall be witnessed by the WSDOT's representative or Agent. Upon completion of sampling, the sample shall be immediately transferred to the WSDOT's representative or Agent who witnessed the sampling operation. The WSDOT's representative or Agent, to assure chain of custody, will deliver the sample(s) to State Materials Laboratory for testing.

The IDR information and pictures will be e-mailed to the State ASA Engineer.

## AIR CONTENT OF FRESHLY MIXED CONCRETE BY THE PRESSURE METHOD FOP FOR AASHTO T 152

### Scope

This procedure covers determination of the air content in freshly mixed Portland Cement Concrete containing dense aggregates in accordance with AASHTO T 152-24, Type B meter. It is not for use with lightweight or highly porous aggregates. This procedure includes standardization of the Type B air meter gauge, Annex.

**Warning**—Fresh Hydraulic cementitious mixtures are caustic and may cause chemical burns to skin and tissue upon prolonged exposure.

### Apparatus

- Air meter: Type B, as described in AASHTO T 152

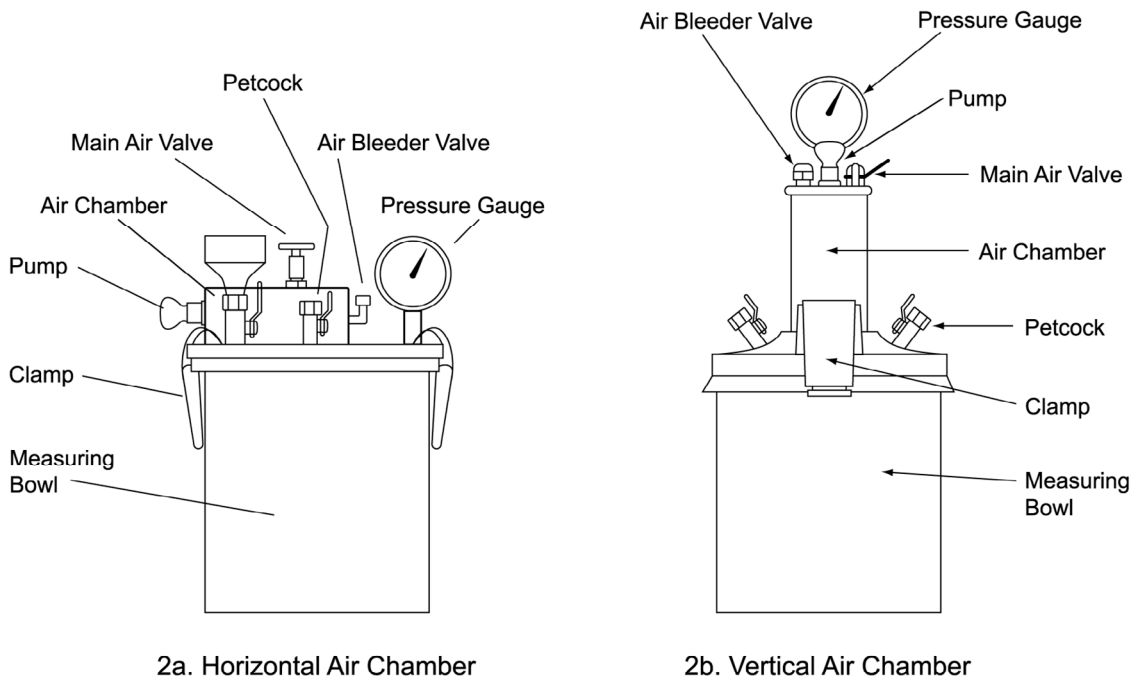

### Type B Meter

- Balance or scale: Accurate to 0.3 percent of the test load at any point within the range of use (for Method 1 standardization only)
- Tamping rod: 16 mm (5/8 in.) diameter and 400 mm (16 in.) to 600 mm (24 in.) long, having a hemispherical tip the same diameter as the rod. (Hemispherical means “half a sphere”; the tip is rounded like half of a ball.)

CONCRETE

WAQTC

FOP AASHTO T 152 (24)

- Vibrator: frequency at least 9000 vibrations per minute (150 Hz), at least 19 to 38 mm (3/4 to 1 1/2 in.) in diameter but not greater than 38 mm (1 1/2 in.), and the length of the shaft shall be at least 75 mm (3 in.) longer than the depth of the section being vibrated.
- Scoop: a receptacle of appropriate size so that each representative increment of the concrete sample can be placed in the container without spillage.
- Container for water: rubber syringe or plastic wash bottle
- Strike-off bar: Approximately 300 mm x 22 mm x 3 mm (12 in. x 3/4 in. x 1/8 in.)
- Strike-off plate: A flat rectangular metal plate at least 6 mm (1/4 in.) thick or a glass or acrylic plate at least 12 mm (1/2 in.) thick, with a length and width at least 50 mm (2 in.) greater than the diameter of the measure with which it is to be used. The edges of the plate shall be straight and smooth within tolerance of 1.5 mm (1/16 in.).  
*Note 1:* Use either the strike-off bar or strike-off plate; both are not required.
- Mallet: With a rubber or rawhide head having a mass of 0.6 ±0.25 kg (1.25 ±0.5 lb)

### Consolidation Selection

There are two methods of consolidating the concrete – rodding and vibration. If the slump is greater than 75 mm (3 in.), consolidation is by rodding. When the slump is 25 to 75 mm (1 to 3 in.), internal vibration or rodding can be used to consolidate the sample, but the method used must be that required by the agency to obtain consistent, comparable results. For concrete with slumps less than 25 mm (1 in.), consolidate the sample by internal vibration. Do not consolidate self-consolidating concrete (SCC).

### Procedure

#### Sampling

1. Obtain the sample in accordance with the FOP for WAQTC TM 2. If the concrete mixture contains aggregate retained on the 37.5 mm (1½ in.) sieve, remove the aggregate by sieving the concrete sample over a 37.5 mm (1½ in.) sieve in accordance with the Wet Sieving portion of the FOP for WAQTC TM 2.

Testing shall begin within five minutes of obtaining the sample.

#### Rodding

1. Dampen the inside of the air meter measure and place on a firm level surface.
2. Use the scoop to fill the measure approximately 1/3 full with concrete. Evenly distribute the concrete in a circular motion around the inner perimeter of the measure.
3. Consolidate the layer with 25 strokes of the tamping rod, using the rounded end. Distribute the strokes evenly over the entire cross section of the concrete. Rod throughout its depth without hitting the bottom too hard.
4. Tap around the perimeter of the measure smartly 10 to 15 times with the mallet to close voids and release trapped air.

40\_T152\_short\_24\_errata

Concrete 13-2

Pub. October 2024 (v. 2025)

CONCRETE

WAQTC

FOP AASHTO T 152 (24)

5. Add the second layer, filling the measure about 2/3 full. Evenly distribute the concrete in a circular motion around the inner perimeter of the measure.
6. Consolidate this layer with 25 strokes of the tamping rod, penetrating about 25 mm (1 in.) into the bottom layer.
7. Tap around the perimeter of the measure smartly 10 to 15 times with the mallet.
8. Add the final layer, slightly overfilling the measure. Evenly distribute the concrete in a circular motion around the inner perimeter of the measure.
9. Consolidate this layer with 25 strokes of the tamping rod, penetrating about 25 mm (1 in.) into the second layer.
10. Tap around the perimeter of the measure smartly 10 to 15 times with the mallet.
11. Continue with 'Strike-off and Air Content.'

### **Internal Vibration**

1. Dampen the inside of the air meter measure and place on a firm level surface.
2. Use the scoop to fill the measure approximately 1/2 full with concrete. Evenly distribute the concrete in a circular motion around the inner perimeter of the measure.
3. Insert the vibrator at three different points. Do not let the vibrator touch the bottom or side of the measure. Remove the vibrator slowly, so that no air pockets are left in the material. Continue vibration only long enough to achieve proper consolidation of the concrete. Over vibration may cause segregation and loss of appreciable quantities of intentionally entrained air.
4. Tap around the perimeter of the measure smartly 10 to 15 times with the mallet.
5. Use the scoop to fill the measure a bit over full. Evenly distribute the concrete in a circular motion around the inner perimeter of the measure.
6. Insert the vibrator at three different points, penetrating the first layer approximately 25 mm (1 in.). Do not let the vibrator touch the side of the measure. Remove the vibrator slowly, so that no air pockets are left in the material. Continue vibration only long enough to achieve proper consolidation of the concrete. Over vibration may cause segregation and loss of appreciable quantities of intentionally entrained air.
7. Tap around the perimeter of the measure smartly 10 to 15 times with the mallet.
8. Continue with 'Strike-off and Air Content.'

**Self-Consolidating Concrete**

1. Dampen the inside of the air meter measure and place on a firm level surface.
2. Use the scoop to slightly overfill the measure. Evenly distribute the concrete in a circular motion around the inner perimeter of the measure.
3. Continue with ‘Strike-off and Air Content.’

**Strike-Off and Air Content**

1. After consolidation, the measure should be slightly over full, about 3 mm (1/8 in.) above the rim. If there is a great excess of concrete, remove a portion with the trowel or scoop. If the measure is under full, add a small quantity. This adjustment may be done only after consolidating the final layer and before striking off the surface of the concrete.
2. Strike off the surface of the concrete and finish it smoothly with a sawing action of the strike-off bar or inclined plate, using great care to leave the measure just full. The surface should be smooth and free of voids.
3. Clean the top flange of the measure to ensure a proper seal.
4. Moisten the inside of the cover and check to see that both petcocks are open, and the main air valve is closed.
5. Clamp the cover on the measure.
6. Inject water through a petcock on the cover until water emerges from the petcock on the opposite side.
7. Jar the meter gently until all air is expelled from this same petcock.
8. Verify that water is present in both petcocks.
9. Close the air bleeder valve and pump air into the air chamber until the needle goes past the initial pressure determined for the gauge. Allow a few seconds for the compressed air to cool.
10. Tap the gauge gently with one hand while slowly opening the air bleeder valve until the needle rests on the initial pressure. Close the air bleeder valve.
11. Close both petcocks.
12. Open the main air valve.
13. Tap the side of the measure smartly with the mallet.
14. With the main air valve open, lightly tap the gauge to settle the needle, and then read the air content to the nearest 0.1 percent.
15. Release or close the main air valve.
16. Open both petcocks to release pressure, remove the concrete, and thoroughly clean the cover and measure with clean water.
17. Open the main air valve to relieve the pressure in the air chamber.

CONCRETE

WAQTC

FOP AASHTO T 152 (24)

**Report**

- On forms approved by the agency
- Sample ID
- Percent of air to the nearest 0.1 percent.
- Some agencies require an aggregate correction factor to determine total percent of entrained air.

Total % entrained air = Gauge reading – aggregate correction factor from mix design  
(See AASHTO T 152 for more information.)

---

**ANNEX**  
**STANDARDIZATION OF AIR METER GAUGE**

(Mandatory Information)

Standardization is a critical step to ensure accurate test results when using this apparatus. Failure to perform the standardization procedures as described below will produce inaccurate or unreliable test results.

Standardization shall be performed at a minimum of once every three months. Record the date of the standardization, the standardization results, and the name of the technician performing the standardization in the logbook kept with each air meter.

There are two methods for standardizing the air meter, mass or volume, both are covered below.

1. Screw the short piece of straight tubing into the threaded petcock hole on the underside of the cover.
2. Determine and record the mass of the dry, empty air meter measure and cover assembly (mass method only).
3. Fill the measure nearly full with water.
4. Clamp the cover on the measure with the tube extending down into the water. Mark the petcock with the tube attached for future reference.
5. Add water through the petcock having the pipe extension below until all air is forced out the other petcock.
6. Wipe off the air meter measure and cover assembly; determine and record the mass of the filled unit (mass method only).
7. Pump up the air pressure to a little beyond the predetermined initial pressure indicated on the gauge. Wait a few seconds for the compressed air to cool, and then stabilize the gauge hand at the proper initial pressure by pumping up or relieving pressure, as needed.
8. Close both petcocks and immediately open the main air valve exhausting air into the measure. Wait a few seconds until the meter needle stabilizes. The gauge should now read 0 percent. If two or more tests show a consistent variation from 0 percent in the result, change the initial pressure line to compensate for the variation, and use the newly established initial pressure line for subsequent tests.
9. Determine which petcock has the straight tube attached to it. Attach the curved tube to external portion of the same petcock.
10. Pump air into the air chamber. Open the petcock with the curved tube attached to it. Open the main air valve for short periods of time until 5 percent of water by mass or volume has been removed from the air meter. Remember to open both petcocks to release the pressure in the measure and drain the water in the curved tube back into the measure. To determine the mass of the water to be removed, subtract the mass found in Step 2 from the mass found in Step 6. Multiply this value by 0.05. This is the mass of the water that must be removed. To remove 5 percent by volume, remove water until the external standardization vessel is level full.



**Note A1:** Many air meters are supplied with a standardization vessel(s) of known volume that are used for this purpose. Standardization vessel must be protected from crushing or denting. If an external standardization vessel is used, confirm what percentage volume it represents for the air meter being used. Vessels commonly represent 5 percent volume, but they are for specific size meters. This should be confirmed by mass.

11. Remove the curved tube. Pump up the air pressure to a little beyond the predetermined initial pressure indicated on the gauge. Wait a few seconds for the compressed air to cool, and then stabilize the gauge hand at the proper initial pressure by pumping up or relieving pressure, as needed.
12. Close both petcocks and immediately open the main air valve exhausting air into the measure. Wait a few seconds until the meter needle is stabilized. The gauge should now read  $5.0 \pm 0.1$  percent. If the gauge is outside that range, the meter needs adjustment. The adjustment could involve adjusting the starting point so that the gauge reads  $5.0 \pm 0.1$  percent when this standardization is run or could involve moving the gauge needle to read 5.0 percent. Any adjustment should comply with the manufacturer's recommendations.
13. When the gauge hand reads correctly at 5.0 percent, additional water may be withdrawn in the same manner to check the results at other values such as 10 percent or 15 percent.
14. If an internal standardization vessel is used, follow Steps 1 through 8 to set initial reading.
15. Release pressure from the measure and remove cover. Place the internal standardization vessel into the measure. This will displace 5 percent of the water in the measure. (See AASHTO T 152 for more information on internal standardization vessels.)
16. Place the cover back on the measure and add water through the petcock until all the air has been expelled.
17. Pump up the air pressure chamber to the initial pressure. Wait a few seconds for the compressed air to cool, and then stabilize the gauge hand at the proper initial pressure by pumping up or relieving pressure, as needed.
18. Close both petcocks and immediately open the main air valve exhausting air into the measure. Wait a few seconds until the meter needle stabilizes. The gauge should now read 5 percent.
19. Remove the extension tubing from threaded petcock hole in the underside of the cover before starting the test procedure.

## Report

- Air meter ID
- Date standardized
- Initial pressure (IP)

CONCRETE

WAQTC

FOP AASHTO T 152 (24)

CONCRETE

WAQTC

FOP AASHTO T 152 (23)

**PERFORMANCE EXAM CHECKLIST****AIR CONTENT OF FRESHLY MIXED CONCRETE BY THE PRESSURE METHOD  
FOP FOR AASHTO T 152**

Participant Name \_\_\_\_\_ Exam Date \_\_\_\_\_

Record the symbols "P" for passing or "F" for failing on each step of the checklist.

<b>Procedure Element</b>	<b>Trial 1</b>	<b>Trial 2</b>
1. Representative sample selected?	_____	_____
<b>First Layer</b>		
2. Dampened measure filled approximately one third full, moving a scoop around the perimeter of the measure to evenly distribute the concrete as discharged?	_____	_____
3. Layer rodded throughout its depth 25 times, without forcibly striking the bottom of the measure, with hemispherical end of rod, uniformly distributing strokes?	_____	_____
4. Perimeter of the measure tapped 10 to 15 times with the mallet after rodding?	_____	_____
<b>Second layer</b>		
5. Measure filled approximately two thirds full, moving a scoop around the perimeter of the measure to evenly distribute the concrete as discharged?	_____	_____
6. Layer rodded throughout its depth, just penetrating the previous layer (approximately 25 mm (1 in.)) 25 times with hemispherical end of rod, uniformly distributing strokes?	_____	_____
7. Perimeter of the measure tapped 10 to 15 times with the mallet after rodding?	_____	_____
<b>Third layer</b>		
8. Measure slightly overfilled, moving a scoop around the perimeter of the measure to evenly distribute the concrete as discharged?	_____	_____
9. Layer rodded throughout its depth, just penetrating the previous layer (approximately 25 mm (1 in.)) 25 times with hemispherical end of rod, uniformly distributing strokes?	_____	_____
10. Perimeter of the measure tapped 10 to 15 times with the mallet after rodding each layer?	_____	_____
11. Concrete struck off level with top of the measure using the bar or inclined strike-off plate?	_____	_____
12. Top flange of measure cleaned?	_____	_____

**OVER**

30\_T152\_pr\_23

Concrete 7-15

Pub. October 2024 (v. 2025)

CONCRETE

WAQTC

FOP AASHTO T 152 (23)

**Procedure Element**

**Trial 1 Trial 2**

**Using a Type B Meter:**

- 13. Both petcocks open? \_\_\_\_\_
- 14. Air valve closed between air chamber and the measure? \_\_\_\_\_
- 15. Inside of cover cleaned and moistened before clamping to base? \_\_\_\_\_
- 16. Water injected through petcock until it flows out the other petcock? \_\_\_\_\_
- 17. Meter jarred gently until all air is expelled? \_\_\_\_\_
- 18. Water is present in both petcocks? \_\_\_\_\_
- 19. Air pumped up to just past initial pressure line? \_\_\_\_\_
- 20. A few seconds allowed for the compressed air to stabilize? \_\_\_\_\_
- 21. Gauge adjusted to the initial pressure? \_\_\_\_\_
- 22. Both petcocks closed? \_\_\_\_\_
- 23. Air valve opened between chamber and measure? \_\_\_\_\_
- 24. The outside of measure tapped smartly with the mallet? \_\_\_\_\_
- 25. With the main air valve open, gauge lightly tapped and air percentage read to the nearest 0.1 percent? \_\_\_\_\_
- 26. Air valve released or closed and then petcocks opened to release pressure before removing the cover? \_\_\_\_\_
- 27. Aggregate correction factor applied if required? \_\_\_\_\_
- 28. Air content recorded to 0.1 percent? \_\_\_\_\_

Comments: First attempt: Pass \_\_\_\_\_ Fail \_\_\_\_\_ Second attempt: Pass \_\_\_\_\_ Fail \_\_\_\_\_

\_\_\_\_\_

\_\_\_\_\_

\_\_\_\_\_

\_\_\_\_\_

\_\_\_\_\_

\_\_\_\_\_

\_\_\_\_\_

Examiner Signature \_\_\_\_\_ WAQTC #: \_\_\_\_\_

This checklist is derived, in part, from copyrighted material printed in ACI CP-1, published by the American Concrete Institute.

## **BULK SPECIFIC GRAVITY ( $G_{mb}$ ) OF COMPACTED ASPHALT MIXTURES USING SATURATED SURFACE-DRY SPECIMENS FOP FOR AASHTO T 166**

### **Scope**

This procedure covers the determination of bulk specific gravity ( $G_{mb}$ ) of compacted asphalt mixtures using three methods – A, B, and C – in accordance with AASHTO T 166-24. This FOP is for use on specimens not having open or interconnecting voids or absorbing more than 2.00 percent water by volume, or both. When specimens have open or interconnecting voids or absorbing more than 2.00 percent water by volume, or both, AASHTO T 275 or AASHTO T 331 should be performed.

### **Overview**

- Method A: Suspension
- Method B: Volumeter
- Method C: Rapid test for A or B

### **Test Specimens**

Test specimens may be either laboratory-molded or sampled from asphalt mixture pavement. For specimens it is recommended that the diameter be equal to four times the maximum size of the aggregate and the thickness be at least one- and one-half times the maximum size.

### **Terminology**

*Constant Mass:* The state at which a mass does not change more than a given percent, after additional drying for a defined time interval, at a required temperature.

### **Apparatus – Method A (Suspension)**

- Balance or scale: 5 kg capacity, readable to 0.1 g, and fitted with a suitable suspension apparatus and holder to permit weighing the specimen while suspended in water, conforming to AASHTO M 231.
- Suspension apparatus: Wire of the smallest practical size and constructed to permit the container to be fully immersed.
- Potable water: Water that is suitable for drinking.
- Water bath: For immersing the specimen in water while suspended under the balance or scale and equipped with an overflow outlet for maintaining a constant water level. Use potable water to fill the water bath. The water in the bath does not need to maintain a potable condition but must remain clear at all times.

ASPHALT

WAQTC

FOP AASHTO T 166 (24)

- Towel: Damp cloth towel used for surface drying specimens.
- Oven: Capable of maintaining a temperature of  $52 \pm 3^{\circ}\text{C}$  ( $126 \pm 5^{\circ}\text{F}$ ) for drying the specimens to a constant mass.
- Pan: Pan or other suitable container of known mass, large enough to hold a sample for drying in oven.
- Thermometer: Having a range of 15 to  $45^{\circ}\text{C}$  (59 to  $113^{\circ}\text{F}$ ) and, graduated in  $0.1^{\circ}\text{C}$  ( $0.2^{\circ}\text{F}$ ) subdivisions.
- Vacuum device: refer to the FOP for AASHTO R 79 (optional)

### Procedure – Method A (Suspension)

Recently molded laboratory specimens that have not been exposed to moisture do not need drying.

1. Dry the specimen to constant mass, if required.
  - a. Oven method
    - i. Initially dry overnight at  $52 \pm 3^{\circ}\text{C}$  ( $126 \pm 5^{\circ}\text{F}$ ).
    - ii. Determine and record the mass of the specimen. Designate this mass as  $M_p$ .
    - iii. Return the specimen to the oven for at least 2 hours.
    - iv. Determine and record the mass of the specimen. Designate this mass as  $M_n$ .
    - v. Determine percent change by subtracting the new mass determination,  $M_n$ , from the previous mass determination,  $M_p$ , dividing by the previous mass determination  $M_p$ , and multiplying by 100.
    - vi. Continue drying until there is no more than 0.05 percent change in specimen mass after 2-hour drying intervals (constant mass).
    - vii. Constant mass has been achieved; specimen is defined as dry.
  - b. Vacuum dry method according to the FOP for AASHTO R 79.
2. Cool the specimen in air to  $25 \pm 5^{\circ}\text{C}$  ( $77 \pm 9^{\circ}\text{F}$ ), and determine and record the dry mass to the nearest 0.1 g. Designate this mass as A.
3. Fill the water bath to the overflow level with water at  $25 \pm 1^{\circ}\text{C}$  ( $77 \pm 2^{\circ}\text{F}$ ) and allow the water to stabilize.
4. Zero or tare the balance with the suspension apparatus attached, ensuring that the suspension apparatus is completely submerged and not touching the sides or the bottom of the water bath.
5. Immerse the specimen shaking to remove the air bubbles. Place the specimen on its side in the suspension apparatus. Leave it immersed for  $4 \pm 1$  minutes.

*Note 1:* To expedite the procedure, steps 1 and 2 may be performed last. To further expedite the process, see Method C.

ASPHALT

WAQTC

FOP AASHTO T 166 (24)

6. Determine and record the submerged weight to the nearest 0.1 g. Designate this submerged weight as C.
7. Remove the specimen from the water and quickly surface dry with a damp cloth towel within 5 sec.
8. Zero or tare the balance.
9. Immediately determine and record the mass of the saturated surface-dry (SSD) specimen to nearest 0.1 g. Designate this mass as B. Any water that seeps from the specimen during the mass determination is considered part of the saturated specimen. Do not exceed 15 sec. performing Steps 7 through 9.

### Calculations – Method A (Suspension)

#### Constant Mass:

Calculate constant mass using the following formula:

$$\%Change = \frac{M_p - M_n}{M_p} \times 100$$

Where:

$M_p$  = previous mass measurement, g

$M_n$  = new mass measurement, g

#### Bulk specific gravity ( $G_{mb}$ ) and percent water absorbed:

$$G_{mb} = \frac{A}{B - C}$$

$$\text{Percent Water Absorbed (by volume)} = \frac{B - A}{B - C} \times 100$$

Where:

$G_{mb}$  = Bulk specific gravity

A = Mass of dry specimen in air, g

B = Mass of SSD specimen in air, g

C = Weight of specimen in water at  $25 \pm 1^\circ\text{C}$  ( $77 \pm 2^\circ\text{F}$ ), g

**Example:**

$$G_{mb} = \frac{4833.6 \text{ g}}{4842.4 \text{ g} - 2881.3 \text{ g}} = 2.465$$

$$\% \text{ Water Absorbed (by volume)} = \frac{4842.4 \text{ g} - 4833.6 \text{ g}}{4842.4 \text{ g} - 2881.3 \text{ g}} \times 100 = 0.45\%$$

Given:

A	=	4833.6 g
B	=	4842.4 g
C	=	2881.3 g

**Apparatus – Method B (Volumeter)**

- Balance or scale: 5 kg capacity, readable to 0.1 g and conforming to AASHTO M 231.
- Potable water: Water that is suitable for drinking.
- Water bath: For immersing the specimen in water, capable of maintaining a uniform temperature at  $25 \pm 1^\circ\text{C}$  ( $77 \pm 2^\circ\text{F}$ ). Use potable water to fill the water bath. The water in the bath does not need to maintain a potable condition but must remain clear at all times.
- Thermometer: Range of 15 to  $45^\circ\text{C}$  ( $59$  to  $113^\circ\text{F}$ ) and graduated in  $0.1^\circ\text{C}$  ( $0.2^\circ\text{F}$ ) subdivisions.
- Distilled water: Clear, distilled water for filling the volumeter.
- Volumeter: Calibrated to 1200 mL or appropriate capacity for specimen and having a tapered lid with a capillary bore.
- Oven: Capable of maintaining a temperature of  $52 \pm 3^\circ\text{C}$  ( $126 \pm 5^\circ\text{F}$ ) for drying the specimens to a constant mass.
- Pan: Pan or other suitable container of known mass, large enough to hold a specimen for drying in oven.
- Towel: Damp cloth towel used for surface drying specimens.
- Vacuum device: refer to the FOP for AASHTO R 79 (optional)



**Procedure – Method B (Volumeter)**

Method B is not acceptable for use with specimens that have more than 6 percent air voids. Recently molded laboratory specimens that have not been exposed to moisture do not need drying.

1. Dry the specimen to constant mass, if required.
  - a. Oven method:
    - i. Initially dry overnight at  $52 \pm 3^{\circ}\text{C}$  ( $126 \pm 5^{\circ}\text{F}$ ).
    - ii. Determine and record the mass of the specimen. Designate this mass as  $M_p$ .
    - iii. Return the specimen to the oven for at least 2 hours.
    - iv. Determine and record the mass of the specimen. Designate this mass as  $M_n$ .
    - v. Determine percent change by subtracting the new mass determination,  $M_n$ , from the previous mass determination,  $M_p$ , dividing by the previous mass determination,  $M_p$ , and multiplying by 100.
    - vi. Continue drying until there is no more than 0.05 percent change in specimen mass after 2-hour drying intervals (constant mass).
    - vii. Constant mass has been achieved; specimen is defined as dry.
  - b. Vacuum dry method according to the FOP for AASHTO R 79.

*Note 1:* To expedite the procedure, steps 1 and 2 may be performed last. To further expedite the process, see Method C.

2. Cool the specimen in air to  $25 \pm 5^{\circ}\text{C}$  ( $77 \pm 9^{\circ}\text{F}$ ), and determine and record the dry mass to the nearest 0.1 g. Designate this mass as A.
3. Immerse the specimen in the temperature-controlled water bath at  $25 \pm 1^{\circ}\text{C}$  ( $77 \pm 2^{\circ}\text{F}$ ) for at least 10 minutes.
4. At the end of the ten-minute period, fill the volumeter with distilled water at  $25 \pm 1^{\circ}\text{C}$  ( $77 \pm 2^{\circ}\text{F}$ ) making sure some water escapes through the capillary bore of the tapered lid.
5. Wipe the volumeter dry. Determine the mass of the volumeter and water to the nearest 0.1 g. Designate this mass as D.
6. Remove the specimen from the water bath and quickly surface dry with a damp cloth towel within 5 sec.
7. Immediately determine and record the mass of the SSD specimen to the nearest 0.1 g. Designate this mass as B. Any water that seeps from the specimen during the mass determination is considered part of the saturated specimen.
8. Place the specimen in the volumeter and let stand 60 sec.
9. Bring the temperature of the water to  $25 \pm 1^{\circ}\text{C}$  ( $77 \pm 2^{\circ}\text{F}$ ) and cover the volumeter, making sure some water escapes through the capillary bore of the tapered lid.
10. Wipe the volumeter dry.

11. Determine and record the mass of the volumeter, water, and specimen to the nearest 0.1 g. Designate this mass as E.

### Calculations – Method B (Volumeter)

#### Constant Mass:

Calculate constant mass using the following formula:

$$\%Change = \frac{M_p - M_n}{M_p} \times 100$$

Where:

$M_p$  = previous mass measurement, g

$M_n$  = new mass measurement, g

#### Bulk specific gravity ( $G_{mb}$ ) and percent water absorbed:

$$G_{mb} = \frac{A}{B + D - E}$$

$$\text{Percent Water Absorbed (by volume)} = \frac{B - A}{B + D - E} \times 100$$

Where:

$G_{mb}$  = Bulk specific gravity

A = Mass of dry specimen in air, g

B = Mass of SSD specimen in air, g

D = Mass of volumeter filled with water at  $25 \pm 1^\circ\text{C}$  ( $77 \pm 2^\circ\text{F}$ ), g

E = Mass of volumeter filled with specimen and water, g

ASPHALT

WAQTC

FOP AASHTO T 166 (24)

**Example:**

$$G_{mb} = \frac{4833.6 \text{ g}}{4842.4 \text{ g} + 2924.4 \text{ g} - 5806.0 \text{ g}} = 2.465$$

$$\% \text{ Water Absorbed (by volume)} = \frac{4842.4 \text{ g} - 4833.6 \text{ g}}{4842.4 \text{ g} + 2924.4 \text{ g} - 5806.0 \text{ g}} \times 100 = 0.45\%$$

Given:

A	=	4833.6 g
B	=	4842.4 g
D	=	2924.4 g
E	=	5806.0 g

**Apparatus – Method C (Rapid Test for Method A or B)**

- Oven: Capable of maintaining a temperature of  $110 \pm 5^\circ\text{C}$  ( $230 \pm 9^\circ\text{F}$ ) for drying the specimens to a constant mass.

See Methods A or B.

*Note 2:* This procedure can be used for specimens that are not required to be saved and contain substantial amounts of moisture. Cores can be tested the same day as obtained by this method.

**Procedure – Method C (Rapid Test for Method A or B)**

1. Start on Step 3 of Method A or B, and complete that procedure, then determine dry mass, A, as follows.
2. Determine and record mass of a large, flat-bottom container.
3. Place the specimen in the container.
4. Place in an oven at  $110 \pm 5 \text{ C}$  ( $230 \pm 9 \text{ F}$ ).
5. Dry until the specimen can be easily separated into fine aggregate particles that are not larger than 6.3 mm ( $\frac{1}{4}$  in.).
6. Determine and record the mass of the specimen. Designate this mass as  $M_p$ .
7. Return the specimen to the oven for at least 2 hours.
8. Determine and record the mass of the specimen. Designate this mass as  $M_n$ .

ASPHALT

WAQTC

FOP AASHTO T 166 (24)

9. Determine percent change by subtracting the new mass determination,  $M_n$ , from the previous mass determination,  $M_p$ , dividing by the previous mass determination,  $M_p$ , and multiplying by 100.
10. Continue drying until there is no more than 0.05 percent change in specimen mass after 2-hour drying intervals (constant mass).
11. Constant mass has been achieved; specimen is defined as dry.
12. Cool in air to  $25 \pm 5^\circ\text{C}$  ( $77 \pm 9^\circ\text{F}$ ).
13. Determine and record the mass of the container and dry specimen to the nearest 0.1 g.
14. Determine and record the mass of the dry specimen to the nearest 0.1 g by subtracting the mass of the container from the mass determined in Step 13. Designate this mass as A.

### Calculations – Method C (Rapid Test for Method A or B)

Complete the calculations as outlined in Methods A or B, as appropriate.

### Report

- On forms approved by the agency
- Sample ID
- $G_{mb}$  to the nearest 0.001
- Absorption to the nearest 0.01 percent
- Method performed.

**PERFORMANCE EXAM CHECKLIST**

**BULK SPECIFIC GRAVITY OF COMPACTED ASPHALT MIXTURES USING SATURATED SURFACE-DRY SPECIMENS FOP FOR AASHTO T 166**

Participant Name \_\_\_\_\_ Exam Date \_\_\_\_\_

**Record the symbols “P” for passing or “F” for failing on each step of the checklist.**

<b>Procedure Element</b>	<b>Trial 1</b>	<b>Trial 2</b>
<b>Method A:</b>		
1. Mass of dry sample determined.		
a. Sample dried to constant mass if required?	_____	_____
b. Cooled in air to 25 ±5°C (77 ±9°F)?	_____	_____
c. Dry mass determined to 0.1g?	_____	_____
2. Water at the overflow and apparatus completely submerged?	_____	_____
3. Balance zeroed?	_____	_____
4. Immersed weight determined.		
a. Water at 25 ±1°C (77 ±2°F)?	_____	_____
b. Immersed, shaken, on side, for 4 ±1 min.?	_____	_____
c. Immersed weight determined to 0.1g?	_____	_____
5. Sample rapidly surface dried (within 5 sec.) with a damp towel and saturated surface dry (SSD) mass determined to 0.1 g (entire operation performed within 15 sec.)?	_____	_____
6. $G_{mb}$ calculated to the nearest 0.001?	_____	_____
7. Absorption calculated to the nearest 0.01 percent	_____	_____

**OVER**

**Procedure Element****Trial 1 Trial 2****Method B:**

- |  |       |       |
|--|-------|-------|
| 1. Specimen dried, cooled, and mass determined as in Method A?   | _____ | _____ |
| 2. Saturated surface-dry (SSD) mass determined to 0.1g.  |       |       |
| a. Immersed at least 10 minutes at 25 ±1°C (77 ±2°F)?  | _____ | _____ |
| b. Sample rapidly dried (within 5 sec.) with damp towel ?  | _____ | _____ |
| c. Specimen mass determined to 0.1 g?  | _____ | _____ |
| d. Any water that seeps from specimen included in mass?  | _____ | _____ |
| 3. Mass of volumeter filled with distilled water at 25 ±1°C (77 ±2°F) determined?  | _____ | _____ |
| 4. SSD specimen placed into volumeter and let stand for 1 minute?  | _____ | _____ |
| 5. Temperature of water brought to 25 ±1°C (77 ±2°F) and volumeter covered, allowing some water to escape through the capillary bore of the tapered lid? | _____ | _____ |
| 6. Volumeter wiped dry, and mass of volumeter and contents determined?   | _____ | _____ |
| 7. $G_{mb}$ calculated to the nearest 0.001?   | _____ | _____ |
| 8. Absorption calculated to the nearest 0.01 percent?  | _____ | _____ |

**Method C/A:**

- |   |       |       |
|---|-------|-------|
| 1. Immersed weight determined.  |       |       |
| a. Water at 25 ±1°C (77 ±2°F)?  | _____ | _____ |
| b. Immersed, shaken, on side, for 4 ±1 minutes?   | _____ | _____ |
| c. Immersed weight determined to 0.1 g?   | _____ | _____ |
| 2. Sample rapidly surface dried with damp cloth (within 5 sec.)?                                    | _____ | _____ |
| 3. Saturated surface dry mass determined to 0.1 g?  | _____ | _____ |
| 4. Dry mass determined by:  |       |       |
| a. Heating in oven at 110 ± 5 C (230 ± 9 F)?  | _____ | _____ |
| b. Breaking down to 6.3 mm (¼ in.) particles?   | _____ | _____ |
| c. Drying in oven to constant mass (change less than 0.05 percent in 2 hours of additional drying)? | _____ | _____ |
| d. Cooled in air to 25 ±5°C (77 ±9°F) and mass determined to 0.1 g?                                 | _____ | _____ |
| 5. $G_{mb}$ calculated to the nearest 0.001?  | _____ | _____ |
| 6. Absorption calculated to the nearest 0.01?   | _____ | _____ |

**OVER**

ASPHALT

WAQTC

FOP AASHTO T 166 (23)

**Procedure Element**

**Trial 1 Trial 2**

**Method C/B:**

- 1. Saturated surface-dry (SSD) mass determined to 0.1g.
  - a. Immersed at least 10 minutes at 25 ±1°C (77 ±2°F)? \_\_\_\_\_
  - b. Sample rapidly dried with damp towel (within 5 sec.)? \_\_\_\_\_
  - c. Specimen mass determined to 0.1g? \_\_\_\_\_
  - d. Any water that seeps from specimen included in mass? \_\_\_\_\_
- 2. Mass of volumeter filled with distilled water at 25 ±1°C (77 ±2°F) determined to 0.1 g? \_\_\_\_\_
- 3. SSD specimen placed into volumeter and let stand for 1 minute? \_\_\_\_\_
- 4. Temperature of water brought to 25 ±1°C (77 ±2°F) and volumeter covered, allowing some water to escape through the capillary pore of the tapered lid? \_\_\_\_\_
- 5. Volumeter wiped dry, and mass of volumeter and contents determined to 0.1 g? \_\_\_\_\_
- 6. Dry mass determined by:
  - a. Heating in oven at 110 ± 5 C (230 ± 9 F)? \_\_\_\_\_
  - b. Breaking down to 6.3 mm (¼ in.) particles? \_\_\_\_\_
  - c. Drying in oven to constant mass (change less than 0.05 percent in 2 hours of additional drying)? \_\_\_\_\_
  - d. Cooled in air to 25 ±5°C (77 ±9°F) and mass determined to 0.1 g? \_\_\_\_\_
- 7. G<sub>mb</sub> calculated to the nearest 0.001? \_\_\_\_\_
- 8. Absorption calculated to the nearest 0.01 percent? \_\_\_\_\_

Comments: First attempt: Pass\_\_\_\_\_Fail\_\_\_\_\_ Second attempt: Pass\_\_\_\_\_Fail\_\_\_\_\_

\_\_\_\_\_

\_\_\_\_\_

\_\_\_\_\_

\_\_\_\_\_

\_\_\_\_\_

\_\_\_\_\_

\_\_\_\_\_

Examiner Signature \_\_\_\_\_ WAQTC #: \_\_\_\_\_

ASPHALT

WAQTC

FOP AASHTO T 166 (23)



## WSDOT Errata to FOP for AASHTO T 176

### *Plastic Fines in Graded Aggregates and Soils by the Use of the Sand Equivalent Test*

WAQTC FOP for AASHTO T 176 has been adopted by WSDOT with the following changes:

#### Sample Preparation

Replace step 7 with below:

7. Repeat steps #5 and #6 obtaining a total of two samples.

Include step 8 below:

8. Dry the two test samples in an oven in accordance with FOP for AASHTO T 255. The oven temperature shall not exceed 350°F (177°C). Cool to room temperature before testing. It is acceptable to place the test sample in a larger container to aid drying.

#### Procedure

6. After loosening the material from the bottom of the cylinder, shake the cylinder and contents by any one of the following methods:
  - c. Hand Method – *Method not recognized by WSDOT.*
10. Clay and sand readings:

Replace step e with below:

- e. If two Sand Equivalent (SE) samples are run on the same material and the second varies by more than  $\pm 8$ , based on the first cylinder result, additional tests shall be run.
- f. *Step not required by WSDOT.*



## PLASTIC FINES IN GRADED AGGREGATES AND SOILS BY THE USE OF THE SAND EQUIVALENT TEST FOP FOR AASHTO T 176

### Scope

This procedure covers the determination of plastic fines in accordance with AASHTO T 176-22. It serves as a rapid test to show the relative proportion of fine dust or clay-like materials in fine aggregates (FA) and soils.

### Apparatus

See AASHTO T 176 for a detailed listing of sand equivalent apparatus. Note that the siphon tube and blow tube may be glass or stainless steel as well as copper.

- Graduated plastic cylinder.
- Rubber stopper.
- Irrigator tube.
- Weighted foot assembly: Having a mass of  $1000 \pm 5$ g. There are two models of the weighted foot assembly. The older model has a guide cap that fits over the upper end of the graduated cylinder and centers the rod in the cylinder. It is read using a slot in the centering screws. The newer model has a sand-reading indicator 254 mm (10 in.) above this point and is preferred for testing clay-like materials.
- Bottle: clean, glass or plastic, of sufficient size to hold working solution
- Siphon assembly: The siphon assembly will be fitted to a 4 L (1 gal.) bottle of working calcium chloride solution placed on a shelf  $915 \pm 25$  mm ( $36 \pm 1$  in.) above the work surface.
- Measuring can: With a capacity of  $85 \pm 5$  mL (3 oz.).
- Balance or scale: Capacity sufficient for sample mass, accurate to 0.1 percent of the sample mass or readable to 0.1 g and meeting the requirements of AASHTO M 231.
- Funnel: With a wide mouth for transferring sample into the graduated cylinder.
- Quartering cloth: 600 mm (2 ft.) square nonabsorbent cloth, such as plastic or oilcloth.
- Mechanical splitter: See the FOP for AASHTO R 76.
- Strike-off bar: A straightedge or spatula.
- Clock or watch reading in minutes and seconds.
- Manual shaker: A manually operated sand equivalent shaker capable of producing an oscillating motion at a rate of 100 complete cycles in  $45 \pm 5$  seconds, with a hand assisted half stroke length of  $127 \pm 5$  mm ( $5 \pm 0.2$  in.). It may be held stable by hand during the shaking operation. It is recommended that this shaker be fastened securely to a firm and level mount, by bolts or clamps, if many determinations are to be made.

- Mechanical shaker: See AASHTO T 176 for equipment and procedure.
- Oven: Capable of maintaining a temperature of  $110 \pm 5^{\circ}\text{C}$  ( $230 \pm 9^{\circ}\text{F}$ ).
- Thermometer: Calibrated liquid-in-glass or electronic digital type designed for total immersion and accurate to  $0.1^{\circ}\text{C}$  ( $0.2^{\circ}\text{F}$ ).
- Sieve: 4.75-mm (No. 4) sieve meeting the requirements of the FOP for AASHTO T 27/T 11

### Materials

- Stock calcium chloride solution: Obtain commercially prepared calcium chloride stock solution meeting AASHTO requirements.
- Working calcium chloride solution: Make 3.8 L (1 gal) of working solution. Fill the bottle with 2 L (1/2 gal) of distilled or demineralized water, add one 3 oz. measuring can ( $85 \pm 5$  mL) of stock calcium chloride solution. Agitate vigorously for 1 to 2 minutes. Add the remainder of the water, approximately 2 L (1/2 gal.) for a total of 3.8 L (1 gal) of working solution. Repeat the agitation process. Tap water may be used if it is proven to be non-detrimental to the test and if it is allowed by the agency. The shelf life of the working solution is approximately 30 days. Label working solution with the date mixed. Discard working solutions more than 30 days old.

*Note 1:* The graduated cylinder filled to 4.4 in. contains 88 mL and may be used to measure the stock solution.

### Control

The temperature of the working solution should be maintained at  $22 \pm 3^{\circ}\text{C}$  ( $72 \pm 5^{\circ}\text{F}$ ) during the performance of the test. If field conditions preclude the maintenance of the temperature range, reference samples should be submitted to the Central/Regional Laboratory, as required by the agency, where proper temperature control is possible. Samples that meet the minimum sand equivalent requirement at a working solution temperature outside of the temperature range need not be subject to reference testing.

### Sample Preparation

1. Obtain the sample in accordance with the FOP for AASHTO R 90 and reduce in accordance with the FOP for AASHTO R 76.
2. Sieve the sample over the 4.75 mm (No. 4) sieve. If the material is in clods, break it up and re-screen it over a 4.75 mm (No. 4) sieve. Clean all fines from particles retained on the 4.75 mm (No. 4) sieve and include with the material passing that sieve.
3. Split or quarter 1000 to 1500 g of material from the portion passing the 4.75 mm (No. 4) sieve. Use extreme care to obtain a truly representative portion of the original sample.

*Note 2:* Experiments show that, as the amount of material being reduced by splitting or quartering is decreased, the accuracy of providing representative portions is reduced. It is imperative that the sample be split or quartered carefully. When it appears necessary, dampen the material before splitting or quartering to avoid segregation or loss of fines.

*Note 3:* All tests, including reference tests, will be performed using Alternative Method No. 2 as described in AASHTO T 176, unless otherwise specified.

4. The sample must have the proper moisture content to achieve reliable results. This condition is determined by tightly squeezing a small portion of the thoroughly mixed sample in the palm of the hand. If the cast that is formed permits careful handling without breaking, the correct moisture content has been obtained.

*Note 4:* Clean sands having little 75  $\mu\text{m}$  (No. 200), such as sand for Portland Cement Concrete (PCC), may not form a cast.

If the material is too dry, the cast will crumble, and it will be necessary to add water and remix and retest until the material forms a cast. When the moisture content is altered to provide the required cast, the altered sample should be placed in a pan, covered with a lid or with a damp cloth that does not touch the material, and allowed to stand for a minimum of 15 minutes. Samples that have been sieved without being air-dried and still retain enough natural moisture are exempted from this requirement.

If the material shows any free water, it is too wet to test and must be drained and air dried. Mix frequently to ensure uniformity. This drying process should continue until squeezing provides the required cast.

5. Place the sample on the quartering cloth and mix by alternately lifting each corner of the cloth and pulling it over the sample toward the diagonally opposite corner, being careful to keep the top of the cloth parallel to the bottom, thus causing the material to be rolled. When the material appears homogeneous, finish the mixing with the sample in a pile near the center of the cloth.
6. Fill the measuring can by pushing it through the base of the pile while exerting pressure with the hand against the pile on the side opposite the measuring can. As the can is moved through the pile, hold enough pressure with the hand to cause the material to fill the tin to overflowing. Press firmly with the palm of the hand, compacting the material and placing the maximum amount in the can. Strike off the can level with the straightedge or spatula.
7. When required, repeat steps 5 and 6 to obtain additional samples.

### Procedure

1. Start the siphon by forcing air into the top of the solution bottle through the tube while the pinch clamp is open. Siphon 101.6  $\pm$  2.5 mm (4  $\pm$  0.1 in.) of working calcium chloride solution into the plastic cylinder.
2. Pour the prepared test sample from the measuring can into the plastic cylinder, using the funnel to avoid spilling.
3. Tap the bottom of the cylinder sharply on the heel of the hand several times to release air bubbles and to promote thorough wetting of the sample.
4. Allow the wetted sample to stand undisturbed for 10  $\pm$  1 minutes.
5. At the end of the 10-minute period, stopper the cylinder and loosen the material from the bottom by simultaneously partially inverting and shaking the cylinder.

6. After loosening the material from the bottom of the cylinder, shake the cylinder and contents by any one of the following methods:
  - a. Mechanical Method – Place the stoppered cylinder in the mechanical shaker, set the timer, and allow the machine to shake the cylinder and contents for  $45 \pm 1$  seconds.

**Caution:** Agencies may require additional operator qualifications for the next two methods.

- b. Manual Method – Secure the stoppered cylinder in the three spring clamps on the carriage of the manually-operated sand equivalent shaker and set the stroke counter to zero. Stand directly in front of the shaker and force the pointer to the stroke limit marker painted on the backboard by applying an abrupt horizontal thrust to the upper portion of the right hand spring strap.

Remove the hand from the strap and allow the spring action of the straps to move the carriage and cylinder in the opposite direction without assistance or hindrance. Apply enough force to the right-hand spring steel strap during the thrust portion of each stroke to move the pointer to the stroke limit marker by pushing against the strap with the ends of the fingers to maintain a smooth oscillating motion. The center of the stroke limit marker is positioned to provide the proper stroke length and its width provides the maximum allowable limits of variation.

Proper shaking action is accomplished when the tip of the pointer reverses direction within the marker limits. Proper shaking action can best be maintained by using only the forearm and wrist action to propel the shaker. Continue shaking for 100 strokes.

- c. Hand Method – Hold the cylinder in a horizontal position and shake it vigorously in a horizontal linear motion from end to end. Shake the cylinder 90 cycles in approximately 30 seconds using a throw of  $229 \text{ mm} \pm 25 \text{ mm}$  ( $9 \pm 1 \text{ in.}$ ). A cycle is defined as a complete back and forth motion. To properly shake the cylinder at this speed, it will be necessary for the operator to shake with the forearms only, relaxing the body and shoulders.
7. Set the cylinder upright on the worktable and remove the stopper.
8. Insert the irrigator tube in the cylinder and rinse material from the cylinder walls as the irrigator is lowered. Force the irrigator through the material to the bottom of the cylinder by applying a gentle stabbing and twisting action while the working solution flows from the irrigator tip. Work the irrigator tube to the bottom of the cylinder as quickly as possible as it becomes more difficult to do this as the washing proceeds. This flushes the fine material into suspension above the coarser sand particles.

Continue to apply a stabbing and twisting action while flushing the fines upward until the cylinder is filled to the 381 mm (15 in.) mark. Then raise the irrigator slowly without shutting off the flow so that the liquid level is maintained at about 381 mm (15 in.) while the irrigator is being withdrawn. Regulate the flow just before the irrigator is entirely withdrawn and adjust the final level to 381 mm (15 in.).

**Note 5:** Occasionally the holes in the tip of the irrigator tube may become clogged by a particle of sand. If the obstruction cannot be freed by any other method, use a pin or other sharp object to force it out, using extreme care not to enlarge the size of the opening. Also, keep the tip sharp as an aid to penetrating the sample.

9. Allow the cylinder and contents to stand undisturbed for 20 minutes  $\pm$ 15 seconds. Start timing immediately after withdrawing the irrigator tube.

**Note 6:** Any vibration or movement of the cylinder during this time will interfere with the normal settling rate of the suspended clay and will cause an erroneous result.

10. Clay and sand readings:

- a. At the end of the 20-minute sedimentation period, read and record the level of the top of the clay suspension. This is referred to as the clay reading.
- b. If no clear line of demarcation has formed at the end of the 20-minute sedimentation period, allow the sample to stand undisturbed until a clay reading can be obtained, then immediately read and record the level of the top of the clay suspension and the total sedimentation time. If the total sedimentation time exceeds 30 minutes, rerun the test using three individual samples of the same material. Read and record the clay column height of the sample requiring the shortest sedimentation period only. Once a sedimentation time has been established, subsequent tests will be run using that time. The time will be recorded along with the test results on all reports.
- c. After the clay reading has been taken, place the weighted foot assembly over the cylinder and gently lower the assembly until it comes to rest on the sand. Do not allow the indicator to hit the mouth of the cylinder as the assembly is being lowered. Subtract 254 mm (10 in.) from the level indicated by the extreme top edge of the indicator and record this value as the sand reading.
- d. If clay or sand readings fall between 2.5 mm (0.1 in.) graduations, record the level of the higher graduation as the reading. For example, a clay reading that appears to be 7.95 would be recorded as 8.0; a sand reading that appears to be 3.22 would be recorded as 3.3.
- e. If two Sand Equivalent (SE) samples are run on the same material and the second varies by more than  $\pm 4$ , based on the first cylinder result, additional tests shall be run.
- f. If three or more Sand Equivalent (SE) samples are run on the same material, average the results. If an individual result varies by more than  $\pm 4$ , based on the average result, additional tests shall be run.

## Calculations

Calculate the SE to the nearest 0.1 using the following formula:

$$SE = \frac{\text{Sand Reading}}{\text{Clay Reading}} \times 100$$

**Example**

$$SE = \frac{3.3}{8.0} \times 100 = 41.25 \text{ or } 41.3 \quad \text{Report 42}$$

Given:

Sand Reading = 3.3

Clay Reading = 8.0

*Note 7:* This example reflects the use of equipment made with English units. At this time, equipment made with metric units is not available.

Report the SE as the next higher whole number. In the example above, the 41.3 would be reported as 42. An SE of 41.0 would be reported as 41.

When averaging two or more samples, raise each calculated SE value to the next higher whole number (reported value) before averaging.

**Example:**

calculated value 1 = 41.3

calculated value 2 = 42.8

These values are reported as 42 and 43, respectively.

Average the two reported values:

$$\text{Average SE} = \frac{42 + 43}{2} = 42.5 \quad \text{Report 43}$$

If the average value is not a whole number, raise it to the next higher whole number.

**Report**

- On forms approved by the agency
- Sample ID
- Results to the next higher whole number
- Sedimentation time if over 20 minutes



AGGREGATE

WAQTC

FOP AASHTO T 176 (24)

**PERFORMANCE EXAM CHECKLIST****PLASTIC FINES IN GRADED AGGREGATES AND SOILS BY THE USE OF THE SAND EQUIVALENT TEST  
FOP FOR AASHTO T 176**

Participant Name \_\_\_\_\_ Exam Date \_\_\_\_\_

**Record the symbols "P" for passing or "F" for failing on each step of the checklist.**

<b>Procedure Element</b>	<b>Trial 1</b>	<b>Trial 2</b>
<b>Sample Preparation</b>		
1. Sample passed through 4.75 mm (No. 4) sieve?	_____	_____
2. Material in clods broken up and re-screened?	_____	_____
3. Split or quarter 1,000 to 1,500 g of material passing the 4.75 mm (No. 4) sieve? NOTE: If necessary, the material may be dampened before splitting to avoid segregation or loss of fines.	_____	_____
4. No fines lost?	_____	_____
5. Working solution dated?	_____	_____
6. Temperature of working solution $22 \pm 3^{\circ}\text{C}$ ( $72 \pm 5^{\circ}\text{F}$ )?	_____	_____
7. Working calcium chloride solution $915 \pm 25$ mm ( $36 \pm 1$ in) above the work surface?	_____	_____
8. $101.6 \pm 2.5$ mm ( $4 \pm 0.1$ in) working calcium chloride solution siphoned into cylinder?	_____	_____
9. Material checked for moisture condition by tightly squeezing small portion in palm of hand and forming a cast?	_____	_____
10. Sample at proper water content?	_____	_____
a. If too dry (cast crumbles easily) water added, re-mixed, covered, and allowed to stand for at least 15 minutes?		
b. If too wet (shows free water) sample drained, air dried and mixed frequently?		
11. Sample placed on splitting cloth and mixed by alternately lifting each corner of the cloth and pulling it over the sample toward diagonally opposite corner, causing material to be rolled?	_____	_____
12. Is material thoroughly mixed?	_____	_____
13. When material appears to be homogeneous, mixing finished with sample in a pile near center of cloth?	_____	_____
14. Fill the 85 mL (3 oz) tin by pushing through base of pile with other hand on opposite side of pile?	_____	_____
15. Material fills tin to overflowing?	_____	_____
16. Material compacted into tin with palm of hand?	_____	_____

**OVER**

**Procedure Element**

**Trial 1    Trial 2**

- 17. Tin struck off level using spatula or straightedge? \_\_\_\_\_
- 18. Prepared sample funneled into cylinder with no loss of fines? \_\_\_\_\_
- 19. Bottom of cylinder tapped sharply on heel of hand several times to release air bubbles? \_\_\_\_\_
- 20. Wetted sample allowed to stand undisturbed for 10 min. ±1 min.? \_\_\_\_\_
- 21. Cylinder stoppered and material loosened from bottom by shaking? \_\_\_\_\_
- 22. Stoppered cylinder shaken correctly? \_\_\_\_\_
  - a. Mechanical: for 45 ±1 seconds? \_\_\_\_\_
  - b. Manual: for 100 strokes? \_\_\_\_\_
  - c. Hand: 90 cycles in approximately 30 seconds? \_\_\_\_\_
- 23. Following shaking, cylinder set vertical on work surface and stopper removed? \_\_\_\_\_
- 24. Irrigator tube inserted in cylinder and material rinsed from cylinder walls as irrigator is lowered? \_\_\_\_\_
- 25. Irrigator tube forced through material to bottom of cylinder by gentle stabbing and twisting action? \_\_\_\_\_
- 26. Stabbing and twisting motion applied until cylinder filled to 381 mm (15 in.) mark? \_\_\_\_\_
- 27. Liquid raised and maintained at 381 mm (15 in.) mark while irrigator is being withdrawn? \_\_\_\_\_
- 28. Liquid at the 381 mm (15 in.) mark? \_\_\_\_\_
- 29. Contents let stand 20 minutes ±15 seconds? \_\_\_\_\_
- 30. Timing started immediately after withdrawal of irrigator? \_\_\_\_\_
- 31. No vibration or disturbance of the sample? \_\_\_\_\_
- 32. Readings taken at 20 minutes or up to 30 minutes, when a definite line appears? \_\_\_\_\_
- 33. Clay level correctly read, rounded, and recorded? \_\_\_\_\_
- 34. Weighted foot assembly lowered into cylinder without hitting mouth of cylinder? \_\_\_\_\_
- 35. Sand level correctly read, rounded, and recorded? \_\_\_\_\_
- 36. Calculations performed correctly? \_\_\_\_\_

Comments: First attempt: Pass\_\_\_Fail\_\_\_\_\_ Second attempt:Pass\_\_\_Fail\_\_\_\_\_  
 \_\_\_\_\_  
 \_\_\_\_\_  
 \_\_\_\_\_

**Examiner Signature** \_\_\_\_\_ **WAQTC #:** \_\_\_\_\_

## WSDOT Errata to FOP for AASHTO T 180

### *Moisture-Density Relations of Soils*

### *Using a 4.54 KG (10 LB) Rammer and a 457 MM (18 IN.) Drop*

WAQTC FOP for AASHTO T 180 has been adopted by WSDOT with the following changes:

#### Scope

*Replace with below:*

This procedure covers the determination of the moisture-density relations of soils and soil-aggregate mixtures in accordance with two similar test methods:

AASHTO T 99-22: Methods A, B, C, and D

AASHTO T 180-22: Methods A, B, C, and D

This test method applies to soil mixtures having **30** percent or less retained on the 4.75 mm (No. 4) sieve for methods A or B, or, 30 percent or less retained on the 19 mm ( $\frac{3}{4}$  in) with methods C or D. The retained material is defined as oversize (coarse) material. If no minimum percentage is specified, 5 percent will be used. Samples that contain oversize (coarse) material that meet percent retained criteria should be corrected by using *Annex A, Correction of Maximum Dry Density and Optimum Moisture for Oversized Particles*. Samples of soil or soil-aggregate mixture are prepared at several moisture contents and compacted into molds of specified size, using manual or mechanical rammers that deliver a specified quantity of compactive energy. The moist masses of the compacted samples are multiplied by the appropriate factor to determine wet density values. Moisture contents of the compacted samples are determined and used to obtain the dry density values of the same samples. Maximum dry density and optimum moisture content for the soil or soil-aggregate mixture is determined by plotting the relationship between dry density and moisture content.



**MOISTURE-DENSITY RELATIONS OF SOILS:  
USING A 2.5 KG (5.5 LB) RAMMER AND A 305 MM (12 IN.) DROP****FOP FOR AASHTO T 99****USING A 4.54 KG (10 LB) RAMMER AND A 457 MM (18 IN.) DROP  
FOP FOR AASHTO T 180****Scope**

This procedure covers the determination of the moisture-density relations of soils and soil-aggregate mixtures in accordance with two similar test methods:

- AASHTO T 99-22: Methods A, B, C, and D
- AASHTO T 180-22: Methods A, B, C, and D

This test method applies to soil mixtures having 40 percent or less retained on the 4.75 mm (No. 4) sieve for methods A or B, or 30 percent or less retained on the 19 mm ( $\frac{3}{4}$  in.) sieve with methods C or D. The retained material is defined as oversize (coarse) material. If no minimum percentage is specified, 5 percent will be used. Samples that contain oversize (coarse) material that meet percent retained criteria should be corrected by using *Annex A, Correction of Maximum Dry Density and Optimum Moisture for Oversized Particles*. Samples of soil or soil-aggregate mixture are prepared at several moisture contents and compacted into molds of specified size, using manual or mechanical rammers that deliver a specified quantity of compactive energy. The moist masses of the compacted samples are multiplied by the appropriate factor to determine wet density values. Moisture contents of the compacted samples are determined and used to obtain the dry density values of the same samples. Maximum dry density and optimum moisture content for the soil or soil-aggregate mixture is determined by plotting the relationship between dry density and moisture content.

**Apparatus**

- Mold – Cylindrical mold made of metal with the dimensions shown in Table 1 or Table 2. If permitted by the agency, the mold may be of the “split” type, consisting of two half-round sections, which can be securely locked in place to form a cylinder. Determine the mold volume according to *Annex B, Standardization of the Mold*.
- Mold assembly – Mold, base plate, and a detachable collar.
- Rammer – Manually or mechanically operated rammers as detailed in Table 1 or Table 2. A manually operated rammer shall be equipped with a guide sleeve to control the path and height of drop. The guide sleeve shall have at least four vent holes no smaller than 9.5 mm ( $\frac{3}{8}$  in.) in diameter, spaced approximately 90 degrees apart and approximately 19 mm ( $\frac{3}{4}$  in.) from each end. A mechanically operated rammer will uniformly distribute blows over the sample and will be calibrated with several soil types, and be adjusted, if necessary, to give the same moisture-density results as with the manually operated rammer. For additional information concerning calibration, see AASHTO T 99 and T 180.
- Sample extruder – A jack, lever frame, or other device for extruding compacted specimens from the mold quickly and with little disturbance.

EMBANKMENT AND BASE  
IN-PLACE DENSITY

WAQTC

FOP AASHTO T 99/T 180 (22)

- Balance(s) or scale(s) of the capacity and sensitivity required for the procedure used by the agency.
  - A balance or scale with a capacity of 11.5 kg (25 lb) and a sensitivity of 1 g for obtaining the sample, meeting the requirements of AASHTO M 231, Class G 5.
  - A balance or scale with a capacity of 2 kg and a sensitivity of 0.1 g is used for moisture content determinations done under both procedures, meeting the requirements of AASHTO M 231, Class G 2.
- Drying apparatus – A thermostatically controlled drying oven, capable of maintaining a temperature of  $110 \pm 5^{\circ}\text{C}$  ( $230 \pm 9^{\circ}\text{F}$ ) for drying moisture content samples in accordance with the FOP for AASHTO T 255/T 265.
- Straightedge – A steel straightedge at least 250 mm (10 in.) long, with one beveled edge and at least one surface plane within 0.1 percent of its length, used for final trimming.
- Sieve(s) – 4.75 mm (No. 4) and/or 19.0 mm (3/4 in.), meeting the requirements of FOP for AASHTO T 27/T 11.
- Mixing tools – Miscellaneous tools such as a mixing pan, spoon, trowel, spatula, etc., or a suitable mechanical device, for mixing the sample with water.
- Containers with close-fitting lids to prevent gain or loss of moisture in the sample.

EMBANKMENT AND BASE  
IN-PLACE DENSITY

WAQTC

FOP AASHTO T 99/T 180 (22)

**Table 1**  
**Comparison of Apparatus, Sample, and Procedure – Metric**

	T 99	T 180
Mold Volume, m <sup>3</sup>	Methods A, C: 0.000943 ±0.000014	Methods A, C: 0.000943 ±0.000014
	Methods B, D: 0.002124 ±0.000025	Methods B, D: 0.002124 ±0.000025
Mold Diameter, mm	Methods A, C: 101.60 ±0.40	Methods A, C: 101.60 ±0.4
	Methods B, D: 152.40 ±0.70	Methods B, D: 152.40 ±0.70
Mold Height, mm	116.40 ±0.50	116.40 ±0.50
Detachable Collar Height, mm	50.80 ±0.64	50.80 ±0.64
Rammer Diameter, mm	50.80 ±0.25	50.80 ±0.25
Rammer Mass, kg	2.495 ±0.009	4.536 ±0.009
Rammer Drop, mm	305 ±2	457 ±2
Layers	3	5
Blows per Layer	Methods A, C: 25	Methods A, C: 25
	Methods B, D: 56	Methods B, D: 56
Material Size, mm	Methods A, B: 4.75 minus	Methods A, B: 4.75 minus
	Methods C, D: 19.0 minus	Methods C, D: 19.0 minus
Test Sample Size, kg	Method A: 3 Method C: 5 (1)	Method B: 7 Method D: 11(1)
Energy, kN-m/m <sup>3</sup>	592	2,693

(1) This may not be a large enough sample depending on your nominal maximum size for moisture content samples.

**Table 2**  
**Comparison of Apparatus, Sample, and Procedure – English**

	T 99	T 180
Mold Volume, ft <sup>3</sup>	Methods A, C: 0.0333 ±0.0005	Methods A, C: 0.0333 ±0.0005
	Methods B, D: 0.07500 ±0.0009	Methods B, D: 0.07500 ±0.0009
Mold Diameter, in.	Methods A, C: 4.000 ±0.016	Methods A, C: 4.000 ±0.016
	Methods B, D: 6.000 ±0.026	Methods B, D: 6.000 ±0.026
Mold Height, in.	4.584 ±0.018	4.584 ±0.018
Detachable Collar Height, in.	2.000 ±0.025	2.000 ±0.025
Rammer Diameter, in.	2.000 ±0.025	2.000 ±0.025
Rammer Mass, lb	5.5 ±0.02	10 ±0.02
Rammer Drop, in.	12 ±0.06	18 ±0.06
Layers	3	5
Blows per Layer	Methods A, C: 25	Methods A, C: 25
	Methods B, D: 56	Methods B, D: 56
Material Size, in.	Methods A, B: No. 4 minus	Methods A, B: No.4 minus
	Methods C, D: 3/4 minus	Methods C, D: 3/4 minus
Test Sample Size, lb	Method A: 7 Method C: 12 <sub>(1)</sub>	Method B: 16 Method D: 25 <sub>(1)</sub>
Energy, lb-ft/ft <sup>3</sup>	12,375	56,250

(1) This may not be a large enough sample depending on your nominal maximum size for moisture content samples.

## Sample

If the sample is damp, dry it until it becomes friable under a trowel. Drying may be in air or by use of a drying apparatus maintained at a temperature not exceeding 60°C (140°F). Thoroughly break up aggregations in a manner that avoids reducing the natural size of individual particles.

Obtain a representative test sample of the mass required by the agency by passing the material through the sieve required by the agency. See Table 1 or Table 2 for test sample mass and material size requirements.

In instances where the material is prone to degradation, i.e., granular material, a compaction sample with differing moisture contents should be prepared for each point.

If the sample is plastic (clay types), it should stand for a minimum of 12 hours after the addition of water to allow the moisture to be absorbed. In this case, several samples at different moisture contents should be prepared, put in sealed containers, and tested the next day.

*Note 1:* Both T 99 and T 180 have four methods (A, B, C, D) that require different masses and employ different sieves.

## Procedure

During compaction, rest the mold firmly on a dense, uniform, rigid, and stable foundation, or base. This base shall remain stationary during the compaction process.

1. Determine the mass of the clean, dry mold. Include the base plate but exclude the extension collar. Record the mass to the nearest 1 g (0.005 lb).
2. Thoroughly mix the selected representative sample with sufficient water to dampen it to approximately 4 to 8 percentage points below optimum moisture content. For many materials, this condition can be identified by forming a cast by hand.
  - a. Prepare individual samples of plastic or degradable material, increasing moisture contents 1 to 2 percent for each point.
  - b. Allow samples of plastic soil to stand for 12 hrs.
3. Form a specimen by compacting the prepared soil in the mold assembly in approximately equal layers. For each layer:
  - a. Spread the loose material uniformly in the mold.

*Note 2:* It is recommended to cover the remaining material with a non-absorbent sheet or damp cloth to minimize loss of moisture.

- b. Lightly tamp the loose material with the manual rammer or other similar device, this establishes a firm surface.
- c. Compact each layer with uniformly distributed blows from the rammer. See Table 1 for mold size, number of layers, number of blows, and rammer specification for the various test methods. Use the method specified by the agency.
- d. Trim down material that has not been compacted and remains adjacent to the walls of the mold and extends above the compacted surface.



EMBANKMENT AND BASE  
IN-PLACE DENSITY

WAQTC

FOP AASHTO T 99/T 180 (22)

4. Remove the extension collar. Avoid shearing off the sample below the top of the mold. The material compacted in the mold should not be over 6 mm ( $\frac{1}{4}$  in.) above the top of the mold once the collar has been removed.
5. Trim the compacted soil even with the top of the mold with the beveled side of the straightedge.
6. Clean soil from exterior of the mold and base plate.
7. Determine and record the mass of the mold, base plate, and wet soil to the nearest 1 g (0.005 lb).
8. Determine and record the wet mass ( $M_w$ ) of the sample by subtracting the mass in Step 1 from the mass in Step 7.
9. Calculate the wet density ( $\rho_w$ ), in  $\text{kg/m}^3$  ( $\text{lb/ft}^3$ ), by dividing the wet mass by the measured volume ( $V_m$ ).
10. Extrude the material from the mold. For soils and soil-aggregate mixtures, slice vertically through the center and remove one of the cut faces for a representative moisture content sample. For granular materials, a vertical face will not exist. Take a representative sample ensuring that all layers are represented. This sample must meet the sample size requirements of the test method used to determine moisture content.

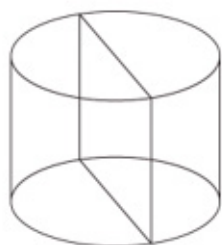

**Extruded material**

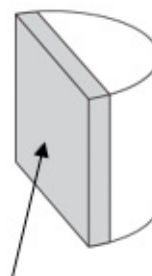

**Representative moisture  
content sample**

**Note 3:** When developing a curve for free-draining soils such as uniform sands and gravels, where seepage occurs at the bottom of the mold and base plate, taking a representative moisture content from the mixing bowl may be preferred in order to determine the amount of moisture available for compaction.

11. Determine and record the moisture content ( $w$ ) of the sample in accordance with the FOP for AASHTO T 255 / T 265.
12. If the material is degradable or plastic, return to Step 3 using a prepared individual sample. If not, continue with Steps 13 through 15.
13. Thoroughly break up the remaining portion of the molded specimen until it will again pass through the sieve, as judged by eye, and add to the remaining portion of the sample being tested.
14. Add sufficient water to increase the moisture content of the remaining soil by 1 to 2 percentage points and repeat steps 3 through 11.

15. Continue determinations until there is either a decrease or no change in the wet mass. There will be a minimum of three points on the dry side of the curve and two points on the wet side. For non-cohesive, drainable soils, one point on the wet side is sufficient.

## Calculations

### Wet Density

$$\rho_w = \frac{M_w}{V_m}$$

Where:

$$\begin{aligned} \rho_w &= \text{wet density, kg/m}^3 \text{ (lb/ft}^3\text{)} \\ M_w &= \text{wet mass} \\ V_m &= \text{volume of the mold, Annex B} \end{aligned}$$

### Dry Density

$$\rho_d = \left( \frac{\rho_w}{w + 100} \right) \times 100 \quad \text{or} \quad \rho_d = \frac{\rho_w}{\left( \frac{w}{100} \right) + 1}$$

Where:

$$\begin{aligned} \rho_d &= \text{dry density, kg/m}^3 \text{ (lb/ft}^3\text{)} \\ w &= \text{moisture content, as a percentage} \end{aligned}$$

### Example for 4-inch mold, Methods A or C

$$\begin{aligned} \text{Wet mass, } M_w &= 1.928 \text{ kg (4.25 lb)} \\ \text{Moisture content, } w &= 11.3\% \\ \text{Measured volume of the mold, } V_m &= 0.000946 \text{ m}^3 \text{ (0.0334 ft}^3\text{)} \end{aligned}$$

### Wet Density

$$\rho_w = \frac{1.928 \text{ kg}}{0.000946 \text{ m}^3} = 2038 \text{ kg/m}^3 \quad \rho_w = \frac{4.25 \text{ lb}}{0.0334 \text{ ft}^3} = 127.2 \text{ lb/ft}^3$$

Where:

$$\rho_w = \text{Wet density, kg/m}^3 \text{ (lb/ft}^3\text{)}$$

EMBANKMENT AND BASE  
IN-PLACE DENSITY

WAQTC

FOP AASHTO T 99/T 180 (22)

### Dry Density

$$\rho_d = \left( \frac{2038 \text{ kg/m}^3}{11.3 + 100} \right) \times 100 = 1831 \text{ kg/m}^3 \quad \rho_d = \left( \frac{127.2 \text{ lb/ft}^3}{11.3 + 100} \right) \times 100 = 114.3 \text{ lb/ft}^3$$

Or

$$\rho_d = \left( \frac{2038 \text{ kg/m}^3}{\frac{11.3}{100} + 1} \right) = 1831 \text{ kg/m}^3 \quad \rho_d = \left( \frac{127.2 \text{ lb/ft}^3}{\frac{11.3}{100} + 1} \right) = 114.3 \text{ lb/ft}^3$$

$$\rho_d = \text{Dry density, kg/m}^3 \text{ (lb/ft}^3\text{)}$$

### Moisture-Density Curve Development

When dry density is plotted on the vertical axis versus moisture content on the horizontal axis and the points are connected with a smooth line, a moisture-density curve is developed. The coordinates of the peak of the curve are the maximum dry density, or just “maximum density,” and the “optimum moisture content” of the soil.

#### Example

Given the following dry density and corresponding moisture content values develop a moisture-density relations curve and determine maximum dry density and optimum moisture content.

Dry Density		Moisture Content, %
kg/m <sup>3</sup>	lb/ft <sup>3</sup>	
1831	114.3	11.3
1853	115.7	12.1
1873	116.9	12.8
1869	116.7	13.6
1857	115.9	14.2

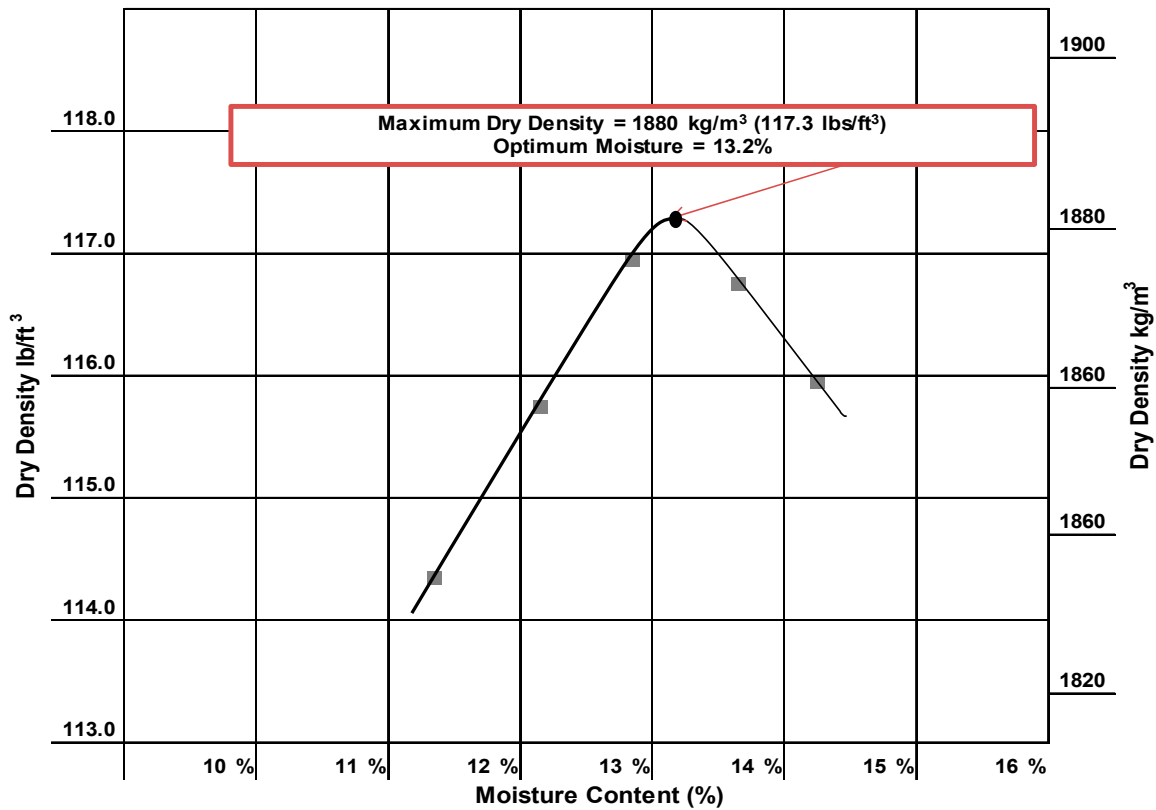

In this case, the curve has its peak at:

$$\begin{aligned} \text{Maximum dry density} &= 1880 \text{ kg/m}^3 (117.3 \text{ lb/ft}^3) \\ \text{Optimum moisture content} &= 13.2\% \end{aligned}$$

Note that both values are approximate since they are based on sketching the curve to fit the points.

## Report

- Results on forms approved by the agency
- Sample ID
- Maximum dry density to the nearest 1 kg/m<sup>3</sup> (0.1 lb/ft<sup>3</sup>)
- Optimum moisture content to the nearest 0.1 percent

**ANNEX A****CORRECTION OF MAXIMUM DRY DENSITY AND OPTIMUM MOISTURE FOR OVERSIZED PARTICLES**

(Mandatory Information)

This section corrects the maximum dry density and moisture content of the material retained on the 4.75 mm (No. 4) sieve, Methods A and B; or the material retained on the 19 mm ( $\frac{3}{4}$  in.) sieve, Methods C and D. The maximum dry density, corrected for oversized particles and total moisture content, are compared with the field-dry density and field moisture content.

This correction can be applied to the sample on which the maximum dry density is performed. A correction may not be practical for soils with only a small percentage of oversize material. The agency shall specify a minimum percentage below which the method is not needed. If not specified, this method applies when more than 5 percent by weight of oversize particles is present.

Bulk specific gravity ( $G_{sb}$ ) of the oversized particles is required to determine the corrected maximum dry density. Use the bulk specific gravity as determined using the FOP for AASHTO T 85 in the calculations. For construction activities, an agency established value or specific gravity of 2.600 may be used.

This correction can also be applied to the sample obtained from the field while performing in-place density.

**Procedure**

1. Use the sample from this procedure or a sample obtained according to the FOP for AASHTO T 310.
2. Sieve the sample on the 4.75 mm (No. 4) sieve for Methods A and B or the 19 mm ( $\frac{3}{4}$  in.) sieve, Methods C and D.
3. Determine the dry mass of the oversized and fine fractions ( $M_{DC}$  and  $M_{DF}$ ) by one of the following:
  - a. Dry the fractions, fine and oversized, in air or by use of a drying apparatus that is maintained at a temperature not exceeding 60°C (140°F).
  - b. Calculate the dry masses using the moisture samples.

To determine the dry mass of the fractions using moisture samples.

1. Determine the moist mass of both fractions, fine ( $M_{Mf}$ ) and oversized ( $M_{Mc}$ ):
2. Obtain moisture samples from the fine and oversized material.
3. Determine the moisture content of the fine particles ( $MC_f$ ) and oversized particles ( $MC_c$ ) of the material by FOP for AASHTO T 255/T 265 or agency approved method.
4. Calculate the dry mass of the oversize and fine particles.

$$M_D = \frac{M_m}{1 + MC}$$

Where:

$M_D$  = mass of dry material (fine or oversize particles)

$M_m$  = mass of moist material (fine or oversize particles)

MC = moisture content of respective fine or oversized, expressed as a decimal

5. Calculate the percentage of the fine ( $P_f$ ) and oversized ( $P_c$ ) particles by dry weight of the total sample as follows: See Note 2.

$$P_f = \frac{100 \times M_{DF}}{M_{DF} + M_{DC}} \quad \frac{100 \times 15.4 \text{ lb}}{15.4 \text{ lbs} + 5.7 \text{ lb}} = 73\% \quad \frac{100 \times 6.985 \text{ kg}}{6.985 \text{ kg} + 2.585 \text{ kg}} = 73\%$$

And

$$P_c = \frac{100 \times M_{DC}}{M_{DF} + M_{DC}} \quad \frac{100 \times 5.7 \text{ lb}}{15.4 \text{ lbs} + 5.7 \text{ lb}} = 27\% \quad \frac{100 \times 2.585 \text{ kg}}{6.985 \text{ kg} + 2.585 \text{ kg}} = 27\%$$

Or for  $P_c$ :

$$P_c = 100 - P_f$$

Where:

$P_f$  = percent of fine particles, of sieve used, by weight

$P_c$  = percent of oversize particles, of sieve used, by weight

$M_{DF}$  = mass of dry fine particles

$M_{DC}$  = mass of dry oversize particles

EMBANKMENT AND BASE  
IN-PLACE DENSITY

WAQTC

FOP AASHTO T 99/T 180 (22)

### Optimum Moisture Correction Equation

1. Calculate the corrected moisture content as follows:

$$MC_T = \frac{(MC_F \times P_f) + (MC_C \times P_c)}{100} = \frac{(13.2\% \times 73.0\%) + (2.1\% \times 27.0\%)}{100} = 10.2\%$$

$MC_T$  = corrected moisture content of combined fines and oversized particles, expressed as a % moisture

$MC_F$  = moisture content of fine particles, as a % moisture

$MC_C$  = moisture content of oversized particles, as a % moisture

**Note 1:** Moisture content of oversize material can be assumed to be two (2) percent for most construction applications.

**Note 2:** In some field applications agencies will allow the percentages of oversize and fine materials to be determined with the materials in the wet state.

### Density Correction Equation

2. Calculate the corrected dry density ( $\rho_d$ ) of the total sample (combined fine and oversized particles) as follows:

$$\rho_d = \frac{100\%}{\left[ \left( \frac{P_f}{\rho_f} \right) + \left( \frac{P_c}{k} \right) \right]}$$

Where:

$\rho_d$  = corrected total dry density (combined fine and oversized particles)  
kg/m<sup>3</sup> (lb/ft<sup>3</sup>)

$\rho_f$  = dry density of the fine particles kg/m<sup>3</sup> (lb/ft<sup>3</sup>), determined in the lab

$P_c$  = percent of dry oversize particles, of sieve used, by weight.

$P_f$  = percent of dry fine particles, of sieve used, by weight.

$k$  = Metric: 1,000 \* Bulk Specific Gravity ( $G_{sb}$ ) (oven dry basis)  
of coarse particles (kg/m<sup>3</sup>).

$k$  = English: 62.4 \* Bulk Specific Gravity ( $G_{sb}$ ) (oven dry basis)  
of coarse particles (lb/ft<sup>3</sup>)

**Note 3:** If the specific gravity is known, then this value will be used in the calculation. For most construction activities the specific gravity for aggregate may be assumed to be 2.600.

**Calculation****Example**

## • Metric:

Maximum laboratory dry density ( $\rho_f$ ):	1880 kg/m <sup>3</sup>
Percent coarse particles ( $P_c$ ):	27%
Percent fine particles ( $P_f$ ):	73%
Mass per volume coarse particles (k):	(2.697) (1000) = 2697 kg/m <sup>3</sup>

$$\rho_d = \frac{100\%}{\left[\left(\frac{P_f}{\rho_f}\right) + \left(\frac{P_c}{k}\right)\right]}$$

$$\rho_d = \frac{100\%}{\left[\left(\frac{73\%}{1880 \text{ kg/m}^3}\right) + \left(\frac{27\%}{2697 \text{ kg/m}^3}\right)\right]}$$

$$\rho_d = \frac{100\%}{[0.03883 \text{ kg/m}^3 + 0.01001 \text{ kg/m}^3]}$$

$$\rho_d = 2047.5 \text{ kg/m}^3 \text{ report } 2048 \text{ kg/m}^3$$



EMBANKMENT AND BASE  
IN-PLACE DENSITY

WAQTC

FOP AASHTO T 99/T 180 (22)

English:

Maximum laboratory dry density ( $\rho_f$ ): 117.3 lb/ft<sup>3</sup>

Percent coarse particles ( $P_c$ ): 27%

Percent fine particles ( $P_f$ ): 73%

Mass per volume of coarse particles ( $k$ ): (2.697) (62.4) = 168.3 lb/ft<sup>3</sup>

$$\rho_d = \frac{100\%}{\left[\left(\frac{P_f}{\rho_f}\right) + \left(\frac{P_c}{k}\right)\right]}$$

$$\rho_d = \frac{100\%}{\left[\left(\frac{73\%}{117.3 \text{ lb/ft}^3}\right) + \left(\frac{27\%}{168.3 \text{ lb/ft}^3}\right)\right]}$$

$$\rho_d = \frac{100\%}{[0.6223 \text{ lb/ft}^3 + 0.1604 \text{ lb/ft}^3]}$$

$$\rho_d = \frac{100\%}{0.7827 \text{ lb/ft}^3}$$

$$\rho_d = 127.76 \text{ lb/ft}^3 \quad \text{Report } 127.8 \text{ lb/ft}^3$$

### Report

- On forms approved by the agency
- Sample ID
- Corrected maximum dry density to the nearest 1 kg/m<sup>3</sup> (0.1 lb/ft<sup>3</sup>)
- Corrected optimum moisture to the nearest 0.1 percent

---

**ANNEX B****STANDARDIZATION OF THE MOLD**

(Mandatory Information)

Standardization is a critical step to ensure accurate test results when using this apparatus. Failure to perform the standardization procedure as described herein will produce inaccurate or unreliable test results.

**Apparatus**

- Mold and base plate
- Balance or scale – Accurate to within 45 g (0.1 lb) or 0.3 percent of the test load, whichever is greater, at any point within the range of use.
- Cover plate – A piece of plate glass, at least 6 mm (1/4 in.) thick and at least 25 mm (1 in.) larger than the diameter of the mold.
- Thermometers – Standardized liquid-in-glass, or electronic digital total immersion type, accurate to 0.5°C (1°F)

**Procedure**

1. Create a watertight seal between the mold and base plate.
2. Determine and record the mass of the dry sealed mold, base plate, and cover plate.
3. Fill the mold with water at a temperature between 16°C and 29°C (60°F and 85°F) and cover with the cover plate in such a way as to eliminate bubbles and excess water.
4. Wipe the outside of the mold, base plate, and cover plate dry, being careful not to lose any water from the mold.
5. Determine and record the mass of the filled mold, base plate, cover plate, and water.
6. Determine and record the mass of the water in the mold by subtracting the mass in Step 2 from the mass in Step 5.
7. Measure the temperature of the water and determine its density from Table B1, interpolating, as necessary.
8. Calculate the volume of the mold,  $V_m$ , by dividing the mass of the water in the mold by the density of the water at the measured temperature.

EMBANKMENT AND BASE  
IN-PLACE DENSITY

WAQTC

FOP AASHTO T 99/T 180 (22)

## Calculations

$$V_m = \frac{M}{\rho_{water}}$$

Where:

$V_m$  = volume of the mold

$M$  = mass of water in the mold

$\rho_{water}$  = density of water at the measured temperature

## Example

Mass of water in mold = 0.94367 kg (2.0800 lb)

$\rho_{water}$  at 23°C (73.4°F) = 997.54 kg/m<sup>3</sup> (62.274 lb/ft<sup>3</sup>)

$$V_m = \frac{0.94367 \text{ kg}}{997.54 \text{ kg/m}^3} = 0.000946 \text{ m}^3 \quad V_m = \frac{2.0800 \text{ lb}}{62.274 \text{ lb/ft}^3} = 0.0334 \text{ ft}^3$$

**Table B1**  
**Unit Mass of Water**  
**15°C to 30°C**

°C	(°F)	kg/m <sup>3</sup>	(lb/ft <sup>3</sup> )	°C	(°F)	kg/m <sup>3</sup>	(lb/ft <sup>3</sup> )
15	(59.0)	999.10	(62.372)	23	(73.4)	997.54	(62.274)
15.6	(60.0)	999.01	(62.366)	23.9	(75.0)	997.32	(62.261)
16	(60.8)	998.94	(62.361)	24	(75.2)	997.29	(62.259)
17	(62.6)	998.77	(62.350)	25	(77.0)	997.03	(62.243)
18	(64.4)	998.60	(62.340)	26	(78.8)	996.77	(62.227)
18.3	(65.0)	998.54	(62.336)	26.7	(80.0)	996.59	(62.216)
19	(66.2)	998.40	(62.328)	27	(80.6)	996.50	(62.209)
20	(68.0)	998.20	(62.315)	28	(82.4)	996.23	(62.192)
21	(69.8)	997.99	(62.302)	29	(84.2)	995.95	(62.175)
21.1	(70.0)	997.97	(62.301)	29.4	(85.0)	995.83	(62.166)
22	(71.6)	997.77	(62.288)	30	(86.0)	995.65	(62.156)

EMBANKMENT AND BASE  
IN-PLACE DENSITY

WAQTC

FOP AASHTO T 99/T 180 (22)

**Report**

- Mold ID
- Date Standardized
- Temperature of the water
- Volume,  $V_m$ , of the mold to the nearest  $0.000001 \text{ m}^3$  ( $0.0001 \text{ ft}^3$ )

## PERFORMANCE EXAM CHECKLIST

### MOISTURE-DENSITY RELATION OF SOILS FOP FOR AASHTO T 180

Participant Name: \_\_\_\_\_ Exam Date: \_\_\_\_\_

Record the symbols “P” for passing or “F” for failing on each step of the checklist.

Procedure Element	Trial 1	Trial 2
1. If damp, sample dried in air or drying apparatus, not exceeding 60°C (140°F)?	_____	_____
2. Sample broken up and an adequate amount sieved over the appropriate sieve (4.75 mm / No. 4 or 19.0 mm / 3/4 in.) to determine oversize (coarse particle) percentage?	_____	_____
3. Sample passing the sieve has appropriate mass?	_____	_____
4. If material is degradable:		
a. Multiple samples mixed with water varying moisture content by 1 to 2 percent, bracketing the optimum moisture content?	_____	_____
5. If soil is plastic (clay types):		
a. Multiple samples mixed with water varying moisture content by 1 to 2 percent, bracketing the optimum moisture content?	_____	_____
b. Samples placed in covered containers and allowed to stand for at least 12 hours?	_____	_____
6. Sample determined to be 4 to 8 percent below expected optimum moisture content?	_____	_____
7. Determine mass of clean, dry mold without collar to nearest 1 g (0.005 lb.)?	_____	_____
8. Mold placed on rigid and stable foundation?	_____	_____
9. Layer of soil (approximately one fifth compacted depth) placed in mold with collar attached, loose material lightly tamped?	_____	_____
10. Soil compacted with appropriate number of blows (25 or 56)?	_____	_____
11. Material adhering to the inside of the mold trimmed?	_____	_____
12. Layer of soil (approximately two fifths compacted depth) placed in mold with collar attached, loose material lightly tamped?	_____	_____
13. Soil compacted with appropriate number of blows (25 or 56)?	_____	_____
14. Material adhering to the inside of the mold trimmed?	_____	_____
15. Layer of soil (approximately three fifths compacted depth) placed in mold with collar attached, loose material lightly tamped?	_____	_____

**OVER**

**Procedure Element**

**Trial 1 Trial 2**

- |   |       |       |
|---|-------|-------|
| 16. Soil compacted with appropriate number of blows (25 or 56)?   | _____ | _____ |
| 17. Material adhering to the inside of the mold trimmed?  | _____ | _____ |
| 18. Layer of soil (approximately four fifths compacted depth) placed in mold with collar attached, loose material lightly tamped?                     | _____ | _____ |
| 19. Soil compacted with appropriate number of blows (25 or 56)?   | _____ | _____ |
| 20. Material adhering to the inside of the mold trimmed?  | _____ | _____ |
| 21. Mold filled with soil such that compacted soil will be above the mold, loose material lightly tamped?   | _____ | _____ |
| 22. Soil compacted with appropriate number of blows (25 or 56)?   | _____ | _____ |
| 23. Collar removed without shearing off sample?   | _____ | _____ |
| 24. Approximately 6 mm (1/4 in.) of compacted material above the top of the mold (without the collar)?  | _____ | _____ |
| 25. Soil trimmed to top of mold with the beveled side of the straightedge?  | _____ | _____ |
| 26. Remove all soil from exterior surface of mold and base plate?   | _____ | _____ |
| 27. Mass of mold and contents determined to nearest 1 g (0.005 lb.)?  | _____ | _____ |
| 28. Wet density calculated from the wet mass?   | _____ | _____ |
| 29. Soil removed from mold using a sample extruder if needed?   | _____ | _____ |
| 30. Soil sliced vertically through center (non-granular material)?  | _____ | _____ |
| 31. Moisture sample removed ensuring all layers are represented?  | _____ | _____ |
| 32. Moist mass determined immediately to 0.1 g?   | _____ | _____ |
| 33. Moisture sample mass of correct size?   | _____ | _____ |
| 34. Sample dried, and water content determined according to the FOP for T 255/T 265?  | _____ | _____ |
| 35. Remainder of material from mold broken up until it will pass through the sieve, as judged by eye, and added to remainder of original test sample? | _____ | _____ |
| 36. Water added to increase moisture content of the remaining sample in approximately 1 to 2 percent increments?                                      | _____ | _____ |
| 37. Steps 2 through 20 repeated for each increment of water added?  | _____ | _____ |
| 38. Process continued until wet density either decreases or stabilizes?   | _____ | _____ |
| 39. Moisture content and dry density calculated for each sample?  | _____ | _____ |
| 40. Dry density plotted on vertical axis, moisture content plotted on horizontal axis, and points connected with a smooth curve?                      | _____ | _____ |

**OVER**

EMBANKMENT AND BASE

WAQTC

FOP AASHTO T 99/T 180 (18)

**Procedure Element**

**Trial 1    Trial 2**

- |   |       |       |
|---|-------|-------|
| 41. Moisture content at peak of curve recorded as optimum water content and recorded to nearest 0.1 percent?                      | _____ | _____ |
| 42. Dry density at optimum moisture content reported as maximum density to nearest 1 kg/m <sup>3</sup> (0.1 lb/ft <sup>3</sup> )? | _____ | _____ |
| 43. Corrected for coarse particles if applicable?   | _____ | _____ |

Comments:      First attempt:    Pass\_\_\_\_\_Fail\_\_\_\_\_      Second attempt:    Pass\_\_\_\_\_Fail\_\_\_\_\_

---

---

---

---

---

---

---

---

---

---

Examiner Signature \_\_\_\_\_ WAQTC #: \_\_\_\_\_

EMBANKMENT AND BASE

WAQTC

FOP AASHTO T 99/T 180 (18)



## Performance Exam Checklist

### AASHTO T 196

#### *Air Content of Concrete (Volumetric Method)*

Participant Name: \_\_\_\_\_ Exam Date: \_\_\_\_\_

Record the symbols "P" for passing or "F" for failing on each step of the checklist.

Procedure Element	Trial 1	Trial 2
1. Bowl filled in two equal layers?	_____	_____
2. Each layer rodded 25 times?	_____	_____
3. Bowl tapped (sharply) 10 to 15 times after rodding each layer?	_____	_____
4. Excess concrete removed with strike-off bar or plate?	_____	_____
5. Flange of bowl wiped clean?	_____	_____
6. Using funnel, water added, then alcohol added, then final water added until liquid level appears in neck?	_____	_____
7. Funnel removed & water adjusted to zero mark using rubber syringe?	_____	_____
8. Screw cap is attached and tightened?	_____	_____
<b>Initial Reading</b>		
9. Unit inverted and agitated at 5 second intervals for a minimum of 45 seconds and until concrete is free from base?	_____	_____
10. Unit vigorously rolled $\frac{1}{4}$ to $\frac{1}{2}$ turn forward and back several times with base at a $45^\circ$ angle. Then turn base about $\frac{1}{8}$ turn and rolling process resumed.	_____	_____
11. Was meter checked for leaking?	_____	_____
a. If leak was found, was test started over with new sample?	_____	_____
12. Apparatus placed upright, top loosened and allowed to stand until air rises to the top?	_____	_____
a. < 0.25 percent change in 2 minutes (without excessive foam), initial reading recorded to the nearest 0.25%?	_____	_____
b. More than 6 minutes to stabilize or excessive foam, was test discarded and new test run?	_____	_____

**Procedure Element**

**Trial 1 Trial 2**

**Confirmation of Initial Meter Reading**

- 13. 1 minute rolling repeated and liquid level checked? \_\_\_\_\_ \_\_\_\_\_
- 14. Confirmation reading > 0.25 percent of initial, new reading recorded as new initial reading, repeat 1 minute rolling \_\_\_\_\_ \_\_\_\_\_
- 15. Level of liquid read < 0.25 percent change, final meter reading recorded to nearest 0.25%? \_\_\_\_\_ \_\_\_\_\_
- 16. Apparatus disassembled and checked for undisturbed concrete \_\_\_\_\_ \_\_\_\_\_

**Calculations**

- 17. Correction factor from Table 1 subtracted for use of 2.5 pts or more of alcohol? \_\_\_\_\_ \_\_\_\_\_
- 18. If required, number of calibration cups of water added to air content? \_\_\_\_\_ \_\_\_\_\_
- 19. Air content reported to the nearest 0.25 percent air? \_\_\_\_\_ \_\_\_\_\_

Comments: First Attempt: Pass \_\_\_\_\_ Fail \_\_\_\_\_ Second Attempt: Pass \_\_\_\_\_ Fail \_\_\_\_\_

Examiner Signature: \_\_\_\_\_ WAQTC #: \_\_\_\_\_

## **THEORETICAL MAXIMUM SPECIFIC GRAVITY ( $G_{mm}$ ) AND DENSITY OF ASPHALT MIXTURES FOP FOR AASHTO T 209**

### **Scope**

This procedure covers the determination of the maximum specific gravity ( $G_{mm}$ ) of uncompacted asphalt mixtures in accordance with AASHTO T 209-23. Two methods using different containers – bowl and pycnometer / volumetric flask– are covered.

Specimens prepared in the laboratory shall be cured according to agency standards.

### **Apparatus**

- Balance or scale: 10,000 g capacity, readable to 0.1 g, meeting AASHTO M 231, Class G2
- Container: A glass, metal, or plastic bowl, pycnometer or volumetric flask between 2000 and 10,000 mL as required by the minimum sample size requirements in Table 1 sample and capable of withstanding full vacuum applied
- Pycnometer / volumetric flask cover: A glass plate or a metal or plastic cover with a vented opening
- Vacuum lid: A transparent lid with a suitable vacuum connection, with a vacuum opening to be covered with a fine wire mesh
- Vacuum pump or water aspirator: Capable of evacuating air from the container to a residual pressure of 3.4 kPa (25 mm Hg)
- Vacuum measurement device: Residual pressure manometer or vacuum gauge, capable of measuring residual pressure down to 3.4 kPa (25 mmHg) or less and readable to at least 0.2 kPa (2 mmHg)
- Suspension apparatus: Suitable apparatus and holder to permit determining the mass of the sample while suspended below the balance. The wire suspending the holder shall be the smallest practical size to minimize any possible effects of a variable immersed length for Bowl Method.
- Water bath: A constant-temperature water bath (optional for Pycnometer or Volumetric Flask Method)
- Thermometers: Thermometric devices accurate to 0.25°C (0.5°F) and with a temperature range of at least 20 to 45°C (68 to 113°F).
- Bleeder valve to adjust vacuum
- Automatic vacuum control unit (optional)
- Timer
- Towel

## Standardization

Use a container that has been standardized according to the Annex. Record the standardized container mass for use in subsequent calculations.

The container shall be standardized periodically in conformance with procedures established by the agency.

## Test Sample Preparation

1. Obtain samples in accordance with the FOP for AASHTO R 97 and reduce according to the FOP for AASHTO R 47.
2. Test sample size shall conform to the requirements of Table 1. Samples larger than the capacity of the container may be tested in two or more increments. Results will be combined by calculating the weighted average ( $G_{mm (avg)}$ ). If the increments have a specific gravity difference greater than 0.013, the test must be re-run.
3. Plant-produced samples may be short-term conditioned according to AASHTO R 30 as specified by the agency.

*Note 1:* Short-term conditioning at the specified temperature is especially important when absorptive aggregates are used. This short-term conditioning will ensure the computation of realistic values for the amount of asphalt absorbed by the aggregate and void properties of the mix. Plant-produced asphalt mixtures should be evaluated to make sure short-term conditioning has taken place during production and delivery.

**Table 1**  
**Test Sample Size for  $G_{mm}$**

Nominal Maximum* Aggregate Size mm (in.)	Minimum Mass g
37.5 or greater (1½)	4000
19 to 25 (¾ to 1)	2500
12.5 or smaller (½)	1500

\*Nominal maximum size: One sieve larger than the first sieve to retain more than 10 percent of the material using an agency specified set of sieves based on cumulative percent retained.

## Procedure – General

Two procedures – bowl and pycnometer / volumetric flask – are covered. The first 11 steps are the same for both.

1. Separate the particles of the sample, taking care not to fracture the mineral particles, so that the particles of the fine aggregate portion are not larger than 6.3 mm (1/4 in.). If the mixture is not sufficiently soft to be separated manually, place it in a large flat pan and warm in an oven only until it is pliable enough for separation.
2. Cool the sample to room temperature.
3. Determine and record the mass of the dry container to the nearest 0.1 g.
4. Place the sample in the container.

5. Determine and record the mass of the dry container and sample to the nearest 0.1 g.
  6. Determine and record the mass of the sample by subtracting the mass determined in Step 3 from the mass determined in Step 5. Designate this mass as “A.”
  7. Add sufficient water at approximately 25° C (77° F) to cover the sample by about 25 mm (1 in.).
- Note 1:** The release of entrapped air may be facilitated by the addition of a wetting agent. Check with the agency to see if this is permitted and, if it is, for a recommended agent.
8. Place the lid on the container and attach the vacuum line. To ensure a proper seal between the container and the lid, wet the O-ring or use a petroleum gel.
  9. Remove entrapped air by subjecting the sample to a partial vacuum of  $4.0 \pm 0.6$  kPa ( $30 \pm 5$  mmHg) residual pressure for  $15 \pm 1$  minutes.
  10. Agitate the container and sample, either continuously by mechanical device or manually by vigorous shaking at 2-minute intervals. This agitation facilitates the removal of air.
  11. Release the vacuum. Increase the pressure to atmospheric pressure in 10 to 15 seconds if the vacuum release is not automated. Turn off the vacuum pump and remove the lid. When performing the pycnometer / volumetric flask method, complete steps 12B through 16B within  $10 \pm 1$  minute.

#### Procedure – Bowl

- 12A. Fill the water bath to overflow level with water at  $25 \pm 1^\circ\text{C}$  ( $77 \pm 2^\circ\text{F}$ ) and allow the water to stabilize.
- 13A. Zero or tare the balance with the immersion apparatus attached, ensuring that the device is not touching the sides or the bottom of the water bath. Immerse the suspension apparatus sufficiently to cover both it and the bowl.
- 14A. Suspend and immerse the bowl and sample in water at  $25 \pm 1^\circ\text{C}$  ( $77 \pm 2^\circ\text{F}$ ) for  $10 \pm 1$  minute.
- 15A. Determine and record the submerged weight of the bowl and sample to the nearest 0.1 g. Designate as “C.”

#### Procedure – Pycnometer or Volumetric Flask

- 12B. Immediately fill the pycnometer / volumetric flask with water without reintroducing air.
  - 13B. Stabilize the temperature of the pycnometer / volumetric flask and sample so that the final temperature is within  $25 \pm 1^\circ\text{C}$  ( $77 \pm 2^\circ\text{F}$ ).
  - 14B. Finish filling the pycnometer / volumetric flask with water that is  $25 \pm 1^\circ\text{C}$  ( $77 \pm 2^\circ\text{F}$ ), place the cover or a glass plate on the pycnometer / volumetric flask, and eliminate all air.
- Note 2:** When using a metal pycnometer and cover, place the cover on the pycnometer and push down slowly, forcing excess water out of the hole in the center of the cover. Use care when filling the pycnometer to avoid reintroducing air into the water.
- 15B. Towel dry the outside of the pycnometer / volumetric flask and cover.

- 16B. Determine and record the mass of the pycnometer / volumetric flask, cover, de-aired water, and sample to the nearest 0.1 g. within  $10 \pm 1$  minute of completion of Step 11. Designate this mass as “E.”

### Procedure – Mixtures Containing Uncoated Porous Aggregate

If the pores of the aggregates are not thoroughly sealed by an asphalt binder film, they may become saturated with water during the vacuuming procedure, resulting in an error in  $G_{mm}$  and theoretical maximum density. To determine if this has occurred, complete the general procedure and then:

1. Carefully drain water from sample through a towel held over the top of the container to prevent loss of material.
2. Spread sample in a flat shallow pan and place before an electric fan to remove surface moisture.
3. Determine the mass of the sample when the surface moisture appears to be gone.
4. Continue drying and determine the mass of the sample at 15-minute intervals until less than a 0.5 g loss is found between determinations.
5. Record the mass as the saturated surface dry mass to the nearest 0.1 g. Designate this mass as “ASSD.”
6. Calculate, as indicated below,  $G_{mm}$  using “A” and “ASSD,” and compare the two values.

### Calculation

Calculate the  $G_{mm}$  to three decimal places as follows:

#### Bowl Procedure

$$G_{mm} = \frac{A}{A + B - C} \quad \text{or} \quad G_{mm} = \frac{A}{A_{SSD} + B - C}$$

(for mixes containing uncoated aggregate materials)

Where:

- A = mass of dry sample in air, g  
 A<sub>SSD</sub> = mass of saturated surface dry sample in air, g  
 B = standardized submerged weight of the bowl, g (see Annex)  
 C = submerged weight of sample and bowl, g

ASPHALT

WAQTC

FOP AASHTO T 209 (23)

**Example:**

$$G_{mm} = \frac{1432.7 \text{ g}}{1432.7 \text{ g} + 286.3 \text{ g} - 1134.9 \text{ g}} = 2.453 \quad \text{or}$$

$$G_{mm} = \frac{1432.7 \text{ g}}{1434.2 \text{ g} + 286.3 \text{ g} - 1134.9 \text{ g}} = 2.447$$

Given:

$$A = 1432.7 \text{ g}$$

$$A_{SSD} = 1434.2 \text{ g}$$

$$B = 286.3 \text{ g}$$

$$C = 1134.9 \text{ g}$$

**Pycnometer / Volumetric Flask Procedure**

$$G_{mm} = \frac{A}{A + D - E} \quad \text{or} \quad G_{mm} = \frac{A}{A_{SSD} + D - E}$$

(for mixtures containing uncoated materials)

Where:

A = mass of dry sample in air, g

A<sub>SSD</sub> = mass of saturated surface-dry sample in air, g

D = standardized mass of pycnometer / volumetric flask filled with water at 25°C (77°F), g, (See Annex)

E = mass of pycnometer / volumetric flask filled with water and the test sample at test temperature, g

**Example (two increments of a large sample):**

$$G_{mm_1} = \frac{2200.3 \text{ g}}{2200.3 \text{ g} + 7502.5 \text{ g} - 8812.0 \text{ g}} = 2.470$$

$$G_{mm_2} = \frac{1960.2 \text{ g}}{1960.2 \text{ g} + 7525.5 \text{ g} - 8690.8 \text{ g}} = 2.466$$

Given:

Increment 1	Increment 2
$A_1 = 2200.3 \text{ g}$	$A_2 = 1960.2 \text{ g}$
$D_1 = 7502.5 \text{ g}$	$D_2 = 7525.5 \text{ g}$
$E_1 = 8812.0 \text{ g}$	$E_2 = 8690.8 \text{ g}$

$$\text{Variation} = 2.470 - 2.466 = 0.004, \text{ which is } < 0.013$$

Allowable variation is: 0.013. The values may be used.

**Weighted average**

For large samples tested a portion at a time, calculate the  $G_{mm(avg)}$  by multiplying the dry mass of each increment by its  $G_{mm}$ , add the results together ( $\Sigma$ ) and divide by the sum ( $\Sigma$ ) of the dry masses.

$$G_{mm(avg)} = \frac{\Sigma(A_x \times G_{mm_x})}{\Sigma A_x}$$

or

$$G_{mm(avg)} = \frac{(A_1 \times G_{mm_1}) + (A_2 \times G_{mm_2})}{A_1 + A_2} \text{ etc.}$$

Where:

- $A_x$  = mass of dry sample increment in air, g
- $G_{mmx}$  = theoretical maximum specific gravity of the increment



ASPHALT

WAQTC

FOP AASHTO T 209 (23)

**Example:**

$$G_{mm(avg)} = \frac{(2200.3 \text{ g} \times 2.470) + (1960.2 \text{ g} \times 2.466)}{2200.3 \text{ g} + 1960.2 \text{ g}} = \frac{10,268.6}{4160.5 \text{ g}} = 2.468$$

**Theoretical Maximum Density**

To calculate the theoretical maximum density at 25°C (77°F) use one of the following formulas. The density of water at 25°C (77°F) is 997.1 kg/ m<sup>3</sup> in Metric units or 62.245 lb/ft<sup>3</sup> in English units.

$$\text{Theoretical maximum density kg/m}^3 = G_{mm} \times 997.1 \text{ kg/ m}^3$$

$$2.468 \times 997.1 \text{ kg/ m}^3 = 2461 \text{ kg/ m}^3$$

or

$$\text{Theoretical maximum density lb/ft}^3 = G_{mm} \times 62.245 \text{ lb/ft}^3$$

$$2.468 \times 62.245 \text{ lb/ft}^3 = 153.6 \text{ lb/ft}^3$$

**Report**

- On forms approved by the agency
- Sample ID
- $G_{mm}$  to the nearest 0.001
- Theoretical maximum density to the nearest 1 kg/m<sup>3</sup> (0.1 lb/ft<sup>3</sup>)

ASPHALT

WAQTC

FOP AASHTO T 209 (23)

---

**ANNEX – STANDARDIZATION OF BOWL AND PYCNOMETER OR VOLUMETRIC FLASK**

(Mandatory Information)

**Bowl – Standardization**

1. Fill the water bath to overflow level with  $25 \pm 1^{\circ}\text{C}$  ( $77 \pm 2^{\circ}\text{F}$ ) water and allow the water to stabilize.
2. Zero or tare the balance with the immersion apparatus attached, ensuring that the device is not touching the sides or the bottom of the water bath. Immerse the suspension apparatus sufficiently to cover both it and the bowl.
3. Suspend and completely immerse the bowl for  $10 \pm 1$  minute.
4. Determine and record the submerged weight of the bowl to the nearest 0.1 g.
5. Refill the water bath to overflow level.
6. Perform Steps 2 through 5 two more times for a total of three determinations.
7. If the range of the three determinations is less than or equal to 0.3 g., average the determinations. Designate as “B.”
8. If the range of the three determinations is greater than 0.3 g., take corrective action and perform the standardization procedure again.

**Bowl – Check**

1. Fill the water bath to overflow level  $25 \pm 1^{\circ}\text{C}$  ( $77 \pm 2^{\circ}\text{F}$ ) water and allow the water to stabilize.
2. Zero or tare the balance with the immersion apparatus attached, ensuring that the device is not touching the sides or the bottom of the water bath. Immerse the suspension apparatus sufficiently to cover both it and the bowl.
3. Suspend and completely immerse the bowl for  $10 \pm 1$  minute.
4. Determine and record the submerged weight of the bowl to the nearest 0.1 g.
5. If this determination is within 0.3 g of the standardized value, use the standardized value for “B.”
6. If it is not within 0.3 g, take corrective action and perform the standardization procedure again.
7. For labs that check the bowl standardization frequently (such as daily), calculate the moving average and range of the last three mass determinations. Designate the average of the last three masses as “B.”
8. If the moving range exceeds 0.3 g at any time, take corrective action and perform the standardization procedure again.

**Pycnometer or Volumetric Flask – Standardization**

1. Fill the pycnometer / volumetric flask with water at approximately 25°C (77°F).
2. Place the metal or plastic cover, or a glass plate on the pycnometer / volumetric flask and eliminate all air. (See Note 2.)
3. Stabilize the pycnometer / volumetric flask at  $25 \pm 1^\circ\text{C}$  ( $77 \pm 2^\circ\text{F}$ ) for  $10 \pm 1$  min.
4. Towel dry the outside of the pycnometer / volumetric flask and cover.
5. Determine and record the mass of the pycnometer / volumetric flask, water, and cover or plate to the nearest 0.1 g.
6. Perform Steps 2 through 5 two more times for a total of three determinations.
7. If the range of the three determinations is less than or equal to 0.3 g, average the three determinations. Designate as “D.”
8. If the range of the determinations is greater than 0.3 g., take corrective action and perform the “Pycnometer or Volumetric Flask – Standardization” again.

**Pycnometer or Volumetric Flask – Check**

1. Fill the pycnometer / volumetric flask with water at approximately 25°C (77°F).
2. Place the metal or plastic cover or a glass plate on the pycnometer / volumetric flask and eliminate all air. (See Note 2.)
3. Stabilize the pycnometer / volumetric flask at  $25 \pm 1^\circ\text{C}$  ( $77 \pm 2^\circ\text{F}$ ) for  $10 \pm 1$  min.
4. Towel dry the outside of the pycnometer / volumetric flask and cover.
5. Determine and record the mass of the pycnometer / volumetric flask, water, and cover or plate.
6. If this determination is within 0.3 g of the standardized value, use the standardized value for “D.”
7. If it is not within 0.3 g, perform the standardization procedure again.

**PERFORMANCE EXAM CHECKLIST**

**THEORETICAL MAXIMUM SPECIFIC GRAVITY (G<sub>mm</sub>) AND DENSITY OF ASPHALT MIXTURES  
FOP FOR AASHTO T 209**

Participant Name \_\_\_\_\_ Exam Date \_\_\_\_\_

Record the symbols “P” for passing or “F” for failing on each step of the checklist.

Procedure Element	Trial 1	Trial 2
1. Sample reduced to correct size?	_____	_____
2. Particles carefully separated insuring that aggregate is not fractured?	_____	_____
3. After separation, fine aggregate particles not larger than 6.3 mm (1/4 in.)?	_____	_____
4. Sample at room temperature?	_____	_____
5. Standardized container (bowl or pycnometer / volumetric flask)?	_____	_____
6. Mass of container determined to 0.1 g?	_____	_____
7. Mass of sample and container determined to 0.1 g?	_____	_____
8. Mass of sample calculated and conforms to required size?	_____	_____
9. Water at approximately 25°C (77°F) added to cover sample?	_____	_____
10. O-ring wet or petroleum gel used?	_____	_____
11. Entrapped air removed using partial vacuum of 4.0 ±0.6 kPa (30 ±5 mm Hg) residual pressure for 15 ±1 min?	_____	_____
12. Container and sample agitated continuously by mechanical device or manually by vigorous shaking at intervals of about 2 minutes?	_____	_____
13. Vacuum released to atmospheric pressure in 10 to 15 seconds if not auto controlled?	_____	_____
14. Vacuum pump turned off?	_____	_____
15. Bowl determination:		
a. Water bath filled to the overflow level?	_____	_____
b. Balance tared?	_____	_____
c. Bowl and sample suspended in water at 25 ±1°C (77 ±2°F) for 10 ±1 minute?	_____	_____
d. Suspension apparatus submerged?	_____	_____
e. Submerged weight of bowl and sample determined to 0.1 g?	_____	_____

**OVER**

ASPHALT

WAQTC

FOP AASHTO T 209 (23)

**Procedure Element**

**Trial 1   Trial 2**

16. Pycnometer / Volumetric Flask determination:

a. Pycnometer / volumetric flask filled with water without reintroducing air into the sample?

\_\_\_\_\_

b. Contents stabilized at 25 ±1°C (77 ±2°F)

\_\_\_\_\_

c. Pycnometer / volumetric flask completely filled with water that is 25 ±1°C (77 ±2°F)?

\_\_\_\_\_

d. Mass of filled pycnometer / volumetric flask and cover determined to 0.1 g, 10 ±1 min. after removal of entrapped air completed?

\_\_\_\_\_

17. G<sub>mm</sub> calculated correctly and reported to 0.001?

\_\_\_\_\_

18. Density calculated correctly and reported to 1 kg/m<sup>3</sup> (0.1 lb/ft<sup>3</sup>)?

\_\_\_\_\_

Comments:      First attempt:   Pass \_\_\_\_\_ Fail \_\_\_\_\_      Second attempt: Pass \_\_\_\_\_ Fail \_\_\_\_\_

\_\_\_\_\_

\_\_\_\_\_

\_\_\_\_\_

\_\_\_\_\_

\_\_\_\_\_

\_\_\_\_\_

\_\_\_\_\_

\_\_\_\_\_

\_\_\_\_\_

\_\_\_\_\_

Examiner Signature \_\_\_\_\_ WAQTC #: \_\_\_\_\_

## **WSDOT FOP for AASHTO T 231**

### ***Capping Cylindrical Concrete Specimens***

WSDOT has adopted the published AASHTO T 231.

*AASHTO Test Methods cannot be included in Materials Manual due to copyright infringement.*

WSDOT employees can access AASHTO and ASTM test methods in the following web address:

[wwwi.wsdot.wa.gov/tools-services/library-services/access-aashto-publications-and-astm-aci-or-sspc-standards](http://wwwi.wsdot.wa.gov/tools-services/library-services/access-aashto-publications-and-astm-aci-or-sspc-standards)

Non-WSDOT employees can order AASHTO's Standard Specifications for Transportation Materials and Methods of Sampling and Testing, using the following web address:

<https://store.transportation.org>





# Performance Exam Checklist

## AASHTO T 231

### *Capping Cylindrical Concrete Specimens*

Participant Name: \_\_\_\_\_ Exam Date: \_\_\_\_\_

Record the symbols "P" for passing or "F" for failing on each step of the checklist.

Procedure Element	Trial 1	Trial 2
1. The tester has a copy of the current procedure on hand?	_____	_____
2. All equipment is functioning according to the test procedure, and if required has the current calibration/standardization/check and maintenance tags present?	_____	_____
3. Sulfur mortar heated to approximately 130°C (265°F), as determined by an all-metal thermometer?	_____	_____
4. Oldest material in pot not been used more than five times?	_____	_____
5. Capping plate or device warmed slightly before use?	_____	_____
6. Capping plate lightly oiled prior to use?	_____	_____
7. Molten sulfur mortar stirred immediately prior to pouring each cap?	_____	_____
8. Ends of specimen dry enough to preclude steam or foam pockets?	_____	_____
9. Capping plate and alignment guides used effectively?	_____	_____
10. Sufficient material used to cover cylinder end and allowed to harden?	_____	_____
11. Caps examined for pockets or hollow areas?	_____	_____
12. Caps checked for planeness?	_____	_____
13. Cylinders kept moist after capping?	_____	_____

Comments: First Attempt: Pass \_\_\_\_\_ Fail \_\_\_\_\_ Second Attempt: Pass \_\_\_\_\_ Fail \_\_\_\_\_

Examiner Signature: \_\_\_\_\_ WAQTC #: \_\_\_\_\_



## WSDOT Errata to FOP for AASHTO T 255

### *Total Evaporable Moisture Content of Aggregate by Drying*

WAQTC FOP for AASHTO T 255 has been adopted by WSDOT with the following changes:

#### Sample Preparation

**TABLE 1 Sample Sizes for Moisture Content of Aggregate** – *Shall conform to the following nominal maximum size definition and include the note below.*

\*For Aggregate, the nominal maximum size sieve is the largest standard sieve opening listed in the applicable specification upon which more than 1-percent of the material by weight is permitted to be retained. For concrete aggregate, the nominal maximum size sieve is the smallest standard sieve opening through which the entire amount of aggregate is permitted to pass.

**Note:** For an aggregate specification having a generally unrestrictive gradation (i.e., wide range of permissible upper sizes), where the source consistently fully passes a screen substantially smaller than the maximum specified size, the nominal maximum size, for the purpose of defining sampling and test specimen size requirements may be adjusted to the screen, found by experience to retain no more than 5 percent of the materials.



## TOTAL EVAPORABLE MOISTURE CONTENT OF AGGREGATE BY DRYING FOP FOR AASHTO T 255

### Scope

This procedure covers the determination of moisture content of aggregate in accordance with AASHTO T 255-22. It may also be used for other construction materials.

### Overview

Moisture content is determined by comparing the wet mass of a sample and the mass of the sample after drying to constant mass. The term constant mass is used to define when a sample is dry.

*Constant mass* – the state at which a mass does not change more than a given percent, after additional drying for a defined time interval, at a required temperature.

### Apparatus

- Balance or scale: Capacity sufficient for the principal sample mass, accurate to 0.1 percent of sample mass or readable to 0.1 g, meeting the requirements of AASHTO M 231.
- Containers: clean, dry, and capable of being sealed
- Suitable drying containers
- Microwave safe container with ventilated lids
- Heat source: thermostatically controlled, capable of maintaining  $110 \pm 5^{\circ}\text{C}$  ( $230 \pm 9^{\circ}\text{F}$ ).
  - Forced draft oven (preferred)
  - Ventilated oven
  - Convection oven
- Heat source, uncontrolled, for use when allowed by the agency, will not alter the material being dried, and close control of the temperature is not required.
  - Infrared heater, hot plate, fry pan, or any other device/method allowed by the agency
  - Microwave oven (900 watts minimum)
- Hot pads or gloves
- Utensils such as spoons

## Sample Preparation

Obtain a representative sample according to the FOP for AASHTO R 90 in its existing condition. If necessary, reduce to moisture content sample size according to the FOP for AASHTO R 76.

The moisture content sample size is based on Table 1 or other information that may be specified by the agency.

**TABLE 1**  
**Sample Sizes for Moisture Content of Aggregate**

Nominal Maximum Size* mm (in.)	Minimum Sample Mass g (lb)
150 (6)	50,000 (110)
100 (4)	25,000 (55)
90 (3 1/2)	16,000 (35)
75 (3)	13,000 (29)
63 (2 1/2)	10,000 (22)
50 (2)	8000 (18)
37.5 (1 1/2)	6000 (13)
25.0 (1)	4000 (9)
19.0 (3/4)	3000 (7)
12.5 (1/2)	2000 (4)
9.5 (3/8)	1500 (3.3)
4.75 (No. 4)	500 (1.1)

\* One sieve larger than the first sieve to retain more than 10 percent of the material using an agency specified set of sieves based on cumulative percent retained. Where large gaps in specification sieves exist, intermediate sieve(s) may be inserted to determine nominal maximum size.

Immediately seal or cover moisture content samples to prevent any change in moisture content or follow the steps in “Procedure.”

## Procedure

Determine all sample masses to the nearest 0.1 percent of the sample mass or to the nearest 0.1 g.

When determining the mass of hot samples or containers or both, place and tare a buffer between the sample container and the balance. This will eliminate damage to or interference with the operation of the balance or scale.

1. Determine and record the mass of the container (and lid for microwave drying).
2. Place the wet sample in the container.
3. Determine and record the total mass of the container and wet sample.

- a. For oven(s), hot plates, infrared heaters, etc.: Spread the sample in the container.
- b. For microwave oven: Heap sample in the container; cover with ventilated lid.
4. Subtract the container mass determined in Step 1 from the mass of the container and sample determined in Step 3 and record the wet mass of the sample ( $M_w$ ).
5. Place the sample in one of the following drying apparatuses:
  - a. Controlled heat source (oven): at  $110 \pm 5^\circ\text{C}$  ( $230 \pm 9^\circ\text{F}$ ).
  - b. Uncontrolled heat source (Hot plate, infrared heater, or other heat sources as allowed by the agency): Stir frequently to avoid localized overheating.
6. Dry until the sample appears moisture free.
7. Determine mass of sample and container.
8. Subtract the container mass determined in Step 1 from the mass of the container and sample determined in Step 7 and record the mass of the sample.
9. Return sample and container to the heat source for the additional time interval.
  - a. Controlled (oven): 30 minutes
  - b. Uncontrolled (Hot plate, infrared heater, or other heat sources as allowed by the agency): 10 minutes
  - c. Uncontrolled (Microwave oven): 2 minutes
- Caution:** Some minerals in the sample may cause the aggregate to overheat, crack and explode, altering the aggregate gradation.
10. Determine mass of sample and container.
11. Subtract the container mass determined in Step 1 from the mass of the container and sample determined in Step 10 and record.
12. Determine percent change by subtracting the new mass determination ( $M_n$ ) from the previous mass determination ( $M_p$ ), dividing by the previous mass determination ( $M_p$ ), and multiplying by 100.
13. Continue drying, performing Steps 9 through 12, until there is less than a 0.10 percent change after additional drying time.
14. Constant mass has been achieved; sample is defined as dry.
15. Allow the sample and container to cool. Determine and record the total mass.
16. Subtract the container mass determined in Step 1 from the mass of the container and sample determined in Step 15 and record the dry mass of the sample ( $M_D$ ).
17. Determine and record percent moisture ( $w$ ) by subtracting the final dry mass determination ( $M_D$ ) from the initial wet mass determination ( $M_w$ ), dividing by the final dry mass determination ( $M_D$ ), and multiplying by 100.

**TABLE 2**  
**Methods of Drying**

Heat Source	Specific Instructions	Drying intervals to achieve constant mass (minutes)
<b>Controlled:</b> Forced Draft Oven (preferred), Ventilated Oven, or Convection Oven	110 ±5°C (230 ±9°F)	30
<b>Uncontrolled:</b>		
Hot plate, Infrared heater, or any other device/method allowed by the agency	Stir frequently	10
Microwave	Heap sample and cover with ventilated lid	2

### Calculation

#### Constant Mass:

Calculate constant mass using the following formula:

$$\% \text{ Change} = \frac{M_p - M_n}{M_p} \times 100$$

where:

$M_p$  = previous mass measurement

$M_n$  = new mass measurement

#### Example:

Mass of container: 1232.1 g

Mass of container after first drying cycle: 2637.2 g

Mass,  $M_p$ , of possibly dry sample: 2637.2 g - 1232.1 g = 1405.1 g

Mass of container and sample after second drying cycle: 2634.1 g

Mass,  $M_n$ , of sample: 2634.1 g - 1232.1 g = 1402.0 g

$$\% \text{ Change} = \frac{1405.1 \text{ g} - 1402.0 \text{ g}}{1405.1 \text{ g}} \times 100 = 0.22\%$$

*0.22 percent is not less than 0.10 percent, so continue drying*



AGGREGATE

WAQTC

FOP AASHTO T 255 (24)

Mass of container and sample after third drying cycle: 2633.0 g

Mass,  $M_n$ , of sample: 2633.0 g - 1232.1 g = 1400.9 g

$$\% \text{ Change} = \frac{1402.0 \text{ g} - 1400.9 \text{ g}}{1402.0 \text{ g}} \times 100 = 0.08\%$$

*0.08 percent is less than 0.10 percent, so constant mass has been reached.*

### Moisture Content:

Calculate the moisture content,  $w$ , as a percent, using the following formula:

$$w = \frac{M_W - M_D}{M_D} \times 100$$

where:

$w$  = moisture content, percent

$M_W$  = wet mass

$M_D$  = dry mass

### Example:

Mass of container: 1232.1 g

Mass of container and wet sample: 2764.7 g

Mass,  $M_W$ , of wet sample: 2764.7 g - 1232.1 g = 1532.6 g

Mass of container and dry sample (COOLED): 2633.5 g

Mass,  $M_D$ , of dry sample: 2633.5 g - 1232.1 g = 1401.4 g

$$w = \frac{1532.6 \text{ g} - 1401.4 \text{ g}}{1401.4 \text{ g}} \times 100 = \frac{131.7 \text{ g}}{1401.4 \text{ g}} = 9.40\% \text{ report } 9.4\%$$

### Report

- On forms approved by the agency
- Sample ID
- $M_W$ , wet mass
- $M_D$ , dry mass
- Moisture content to the nearest 0.1 percent

AGGREGATE

WAQTC

FOP AASHTO T 255 (24)

**PERFORMANCE EXAM CHECKLIST**

**TOTAL MOISTURE CONTENT OF AGGREGATE BY DRYING  
FOP FOR AASHTO T 255**

Participant Name \_\_\_\_\_ Exam Date \_\_\_\_\_

Record the symbols "P" for passing or "F" for failing on each step of the checklist.

Procedure Element	Trial 1	Trial 2
1. Representative sample of appropriate mass obtained?	_____	_____
2. Mass of container determined to 0.1 percent or 0.1 g?	_____	_____
3. Sample placed in container and wet mass determined to 0.1 percent or 0.1 g?	_____	_____
4. Test sample mass conforms to the required mass?	_____	_____
5. Loss of moisture avoided prior to mass determination?	_____	_____
6. Sample dried by a suitable heat source?	_____	_____
7. If aggregate heated by means other than a temperature controlled oven, is sample stirred to avoid localized overheating?	_____	_____
8. If heated in a microwave, heaped and covered with a ventilated lid?	_____	_____
9. Is aggregate heated for the additional, specified time?	_____	_____
a. Forced draft, ventilated, convection ovens – 30 minutes		
b. Microwave – 2 minutes		
c. Other – 10 minutes		
10. Mass determined and compared to previous mass – showing less than 0.10 percent loss?	_____	_____
11. Sample cooled before dry mass determination to 0.1 percent or 0.1 g?	_____	_____
12. Calculations performed properly, and results reported to the nearest 0.1 percent?	_____	_____

Comments:      First attempt: Pass\_\_\_\_Fail\_\_\_\_      Second attempt: Pass\_\_\_\_Fail\_\_\_\_

\_\_\_\_\_

\_\_\_\_\_

\_\_\_\_\_

\_\_\_\_\_

Examiner Signature \_\_\_\_\_ WAQTC #: \_\_\_\_\_

AGGREGATE

WAQTC

FOP AASHTO T 255 (18)

# WSDOT Errata to FOP for AASHTO T 265

## *Laboratory Determination of Moisture Content of Soils*

WAQTC FOP for AASHTO T 265 has been adopted by WSDOT with the following changes:

### Sample Preparation

**TABLE 1 Sample Sizes for Moisture Content of Aggregate** – *Shall conform to the following nominal maximum size definition and include the note below.*

\*For Aggregate, the nominal maximum size sieve is the largest standard sieve opening listed in the applicable specification upon which more than 1-percent of the material by weight is permitted to be retained. For concrete aggregate, the nominal maximum size sieve is the smallest standard sieve opening through which the entire amount of aggregate is permitted to pass.

**Note:** For an aggregate specification having a generally unrestrictive gradation (i.e., wide range of permissible upper sizes), where the source consistently fully passes a screen substantially smaller than the maximum specified size, the nominal maximum size, for the purpose of defining sampling and test specimen size requirements may be adjusted to the screen, found by experience to retain no more than 5 percent of the materials.



**TOTAL EVAPORABLE MOISTURE CONTENT OF AGGREGATE BY DRYING  
FOP FOR AASHTO T 255  
LABORATORY DETERMINATION OF MOISTURE CONTENT OF SOILS  
FOP FOR AASHTO T 265****Scope**

This procedure covers the determination of moisture content of aggregate and soil in accordance with AASHTO T 255-22 and AASHTO T 265-22. It may also be used for other construction materials.

**Overview**

Moisture content is determined by comparing the wet mass of a sample and the mass of the sample after drying to constant mass. The term constant mass is used to define when a sample is dry.

*Constant mass* – the state at which a mass does not change more than a given percent, after additional drying for a defined time interval, at a required temperature.

**Apparatus**

- Balance or scale: capacity sufficient for the principal sample mass, accurate to 0.1 percent of sample mass or readable to 0.1 g, and meeting the requirements of AASHTO M 231
- Containers: clean, dry, and capable of being sealed
- Suitable drying container
  - For soils: container requires close-fitting lid
  - For aggregate: container lid is optional
- Microwave safe container with ventilated lid (for drying aggregate only)
- Heat source, thermostatically controlled, capable of maintaining  $110 \pm 5^{\circ}\text{C}$  ( $230 \pm 9^{\circ}\text{F}$ ).
  - Forced draft oven (preferred)
  - Ventilated oven
  - Convection oven
- Heat source, uncontrolled, for use when allowed by the agency, will not alter the material being dried, and close control of the temperature is not required:
  - Infrared heater/heat lamp, hot plate, fry pan, or any other device/method allowed by the agency .
  - Microwave oven (900 watts minimum)
- Utensils such as spoons
- Hot pads or gloves

**Sample Preparation**

Obtain a representative sample according to the FOP for AASHTO R 90 in its existing condition. If necessary, reduce the sample to moisture content sample size according to the FOP for AASHTO R 76.

For aggregate, the moisture content sample size is based on Table 1 or other information that may be specified by the agency.

**TABLE 1**  
**Sample Sizes for Moisture Content of Aggregate**

<b>Nominal Maximum Size* mm (in.)</b>	<b>Minimum Sample Mass g (lb)</b>
150 (6)	50,000 (110)
100 (4)	25,000 (55)
90 (3 1/2)	16,000 (35)
75 (3)	13,000 (29)
63 (2 1/2)	10,000 (22)
50 (2)	8000 (18)
37.5 (1 1/2)	6000 (13)
25.0 (1)	4000 (9)
19.0 (3/4)	3000 (7)
12.5 (1/2)	2000 (4)
9.5 (3/8)	1500 (3.3)
4.75 (No. 4)	500 (1.1)

\* One sieve larger than the first sieve to retain more than 10 percent of the material using an agency specified set of sieves based on cumulative percent retained. Where large gaps in specification sieves exist, intermediate sieve(s) may be inserted to determine nominal maximum.



For soils the moisture content sample size is based on Table 2 or other information that may be specified by the agency.

**TABLE 2**  
**Sample Sizes for Moisture Content of Soil**

<b>Maximum Particle Size mm (in.)</b>	<b>Minimum Sample Mass g</b>
50 (2)	1000
25.0 (1)	500
12.5 (1/2)	300
4.75 (No. 4)	100
0.425 (No. 40)	10

Immediately seal or cover moisture content samples to prevent any change in moisture content or follow the steps in “Procedure.”

### Procedure

Determine and record the sample masses as follows:

- For aggregate, determine and record all masses to the nearest 0.1 percent of the sample mass or to the nearest 0.1 g.
- For soil, determine and record all masses to the nearest 0.1 g.

When determining the mass of hot samples or containers or both, place and tare a buffer between the sample container and the balance. This will eliminate damage to or interference with the operation of the balance or scale.

1. Determine and record the mass of the container .
  - a. For aggregate: the lid is optional unless drying with a microwave then a ventilated lid is required.
  - b. For soils: the container includes the mass of the close-fitting lid.
2. Remove the lid, if used, and place the wet sample in the container.
3. Determine and record the total mass of the wet sample and container with lid, when used.
  - a. For oven(s), hot plates, infrared heaters, etc.: Spread the sample in the container.
  - b. For microwave oven: Heap sample in the container; cover with ventilated lid.
4. Subtract the container mass determined in Step 1 from the mass of the container and sample determined in Step 3 and record the wet mass of the sample ( $M_w$ ).
5. Place the sample in one of the following drying apparatuses:
  - a. For aggregate –
    - i. Controlled heat source (oven): at  $110 \pm 5^\circ\text{C}$  ( $230 \pm 9^\circ\text{F}$ ).
    - ii. Uncontrolled heat source (Hot plate, infrared heater, or other heat source as allowed by the agency): Stir frequently to avoid localized overheating.

EMBANKMENT AND BASE  
IN-PLACE DENSITY

WAQTC

FOP AASHTO T 255 / T 265 (24)

b. For soil – controlled heat source (oven): at  $110 \pm 5^{\circ}\text{C}$  ( $230 \pm 9^{\circ}\text{F}$ ).

**Note 1:** Soils containing gypsum or significant amounts of organic material require special drying. For reliable moisture contents dry these soils at  $60^{\circ}\text{C}$  ( $140^{\circ}\text{F}$ ). For more information see AASHTO T 265, Note 2.

6. Dry until sample appears moisture free.

7. Determine mass of sample and container and lid, when used.

8. Subtract the container mass determined in Step 1 from the mass of the container and sample determined in Step 7 and record the mass of the sample.

9. Return sample and container to the heat source for the additional time interval.

a. Drying intervals for aggregate –

i. Controlled heat source (oven): 30 minutes

ii. Uncontrolled heat source (Hot plate, infrared heater, or other heat source as allowed by the agency): 10 minutes

iii. Uncontrolled heat source (Microwave oven): 2 minutes

**Caution:** Some minerals in the sample may cause the aggregate to overheat, crack, and explode; altering the aggregate gradation.

b. Drying interval for soil – controlled heat source (oven): 1 hour

10. Determine mass of sample and container with lid, if used.

11. Subtract the container mass determined in Step 1 from the mass of the container and sample determined in Step 10 and record the mass of the sample.

12. Determine percent change by subtracting the new mass determination ( $M_n$ ) from the previous mass determination ( $M_p$ ), dividing by the previous mass determination ( $M_p$ ), and multiplying by 100.

13. Continue drying, performing steps 9 through 12, until there is less than a 0.10 percent change after additional drying time.

14. Constant mass has been achieved; sample is defined as dry.

15. Allow the sample and container with lid, when used, to cool. Determine and record the total mass.

16. Subtract the mass of the container determined in Step 1 from the mass of the container and sample determined in Step 15 and record the dry mass of the sample ( $M_D$ ).

17. Determine and record percent moisture ( $w$ ) by subtracting the final dry mass determination ( $M_D$ ) from the initial wet mass determination ( $M_W$ ), dividing by the final dry mass determination ( $M_D$ ), and multiplying by 100.

**Table 3**  
**Methods of Drying**

<b>Aggregate</b>		
<b>Heat Source</b>	<b>Specific Instructions</b>	<b>Drying intervals to achieve constant mass (minutes)</b>
<b>Controlled:</b>		
Forced draft (preferred), ventilated, or convection oven	110 ±5°C (230 ±9°F)	30
<b>Uncontrolled:</b>		
Hot plate, infrared heater, or any other device/method allowed by the agency	Stir frequently	10
Microwave	Heap sample and cover with ventilated lid	2
<b>Soil</b>		
<b>Heat Source</b>	<b>Specific Instructions</b>	<b>Drying interval to achieve constant mass</b>
<b>Controlled:</b>		
Forced draft (preferred), ventilated, or convection oven	110 ±5°C (230 ±9°F)	1 hour

**Calculation****Constant Mass**

Calculate constant mass using the following formula:

$$\% \text{ Change} = \frac{M_p - M_n}{M_p} \times 100$$

Where:

$M_p$  = previous mass measurement

$M_n$  = new mass measurement

**Example:**

Mass of container:	1232.1 g
Mass of container and sample after first drying cycle:	2637.2 g
Mass, $M_p$ , of possibly dry sample:	$2637.2 \text{ g} - 1232.1 \text{ g} = 1405.1 \text{ g}$
Mass of container and sample after second drying cycle:	2634.1 g
Mass, $M_n$ , of sample:	$2634.1 \text{ g} - 1232.1 \text{ g} = 1402.0 \text{ g}$

$$\% \text{ Change} = \frac{1405.1 \text{ g} - 1402.0 \text{ g}}{1405.1 \text{ g}} \times 100 = 0.22\%$$

*0.22 percent is not less than 0.10 percent, so continue drying.*

Mass of container and sample after third drying cycle: 2633.0 g

Mass,  $M_n$ , of sample:  $2633.0 \text{ g} - 1232.1 \text{ g} = 1400.9 \text{ g}$

$$\% \text{ Change} = \frac{1402.0 \text{ g} - 1400.9 \text{ g}}{1402.0 \text{ g}} \times 100 = 0.08\%$$

*0.08 percent is less than 0.10 percent, so constant mass has been reached.*

EMBANKMENT AND BASE  
IN-PLACE DENSITY

WAQTC

FOP AASHTO T 255 / T 265 (24)

### Moisture Content Aggregate and Soils:

Calculate the moisture content, as a percent, using the following formula:

$$w = \frac{M_W - M_D}{M_D} \times 100$$

where:

w = moisture content, percent

M<sub>w</sub> = wet mass

M<sub>D</sub> = dry mass

Example:

Mass of container: 1232.1 g

Mass of container and wet sample: 2764.7 g

Mass, M<sub>w</sub>, of wet sample: 2764.7 g - 1232.1 g = 1532.6 g

Mass of container and dry sample (COOLED): 2633.5 g

Mass, M<sub>D</sub>, of dry sample: 2633.5 g - 1232.1 g = 1401.4 g

$$w = \frac{1532.6 \text{ g} - 1401.4 \text{ g}}{1401.4 \text{ g}} \times 100 = \frac{131.2 \text{ g}}{1401.4 \text{ g}} \times 100 = 9.36\% \text{ report } 9.4\%$$

### Report

- On forms approved by the agency
- Sample ID
- M<sub>w</sub>, wet mass
- M<sub>D</sub>, dry mass
- w, moisture content to the nearest 0.1 percent

EMBANKMENT AND BASE  
IN-PLACE DENSITY

WAQTC

FOP AASHTO T 255 / T 265 (24)

**PERFORMANCE EXAM CHECKLIST****TOTAL EVAPORABLE MOISTURE CONTENT OF AGGREGATE BY DRYING  
FOP FOR AASHTO T 255****LABORATORY DETERMINATION OF MOISTURE CONTENT OF SOILS  
FOP FOR AASHTO T 265**

Participant Name \_\_\_\_\_ Exam Date \_\_\_\_\_

Record the symbols "P" for passing or "F" for failing on each step of the checklist.

<b>Procedure Element</b>	<b>Trial 1</b>	<b>Trial 2</b>
1. Representative sample of appropriate mass obtained?	_____	_____
2. Sample protected from moisture change?	_____	_____
3. Mass of container determined to 0.1 g?	_____	_____
a. For aggregate: the lid is optional unless drying with a microwave then a ventilated lid is required.		
b. For soils: the container includes the mass of the close-fitting lid.		
4. Sample placed in container, with lid if used, and mass determined to 0.1 g?	_____	_____
5. Wet sample mass recorded to 0.1 g?	_____	_____
6. Sample mass conforms to the required mass?	_____	_____
7. Sample dried by a suitable heat source?	_____	_____
a. Describe suitable heat sources for aggregate?		
b. Describe suitable heat sources for soils?		
8. If aggregate heated by means other than a controlled oven, is sample stirred to avoid localized overheating?	_____	_____
9. For microwave, aggregate heaped and covered with a ventilated lid?	_____	_____
10. For aggregate, heated for the additional, specified time?	_____	_____
a. Forced draft, ventilated, convection ovens – 30 minutes		
b. Microwave – 2 minutes		
c. Other – 10 minutes		
11. For soil, heated for at least 1 hour additional drying time using a controlled heat source?	_____	_____
12. Mass of sample and container, with lid if used, determined and compared to previous mass – showing less than 0.10 percent loss?	_____	_____
13. Sample cooled, dry mass and container, with lid if used, determined and recorded to the nearest 0.1 percent?	_____	_____

**OVER**

EMBANKMENT AND BASE

WAQTC

FOP AASHTO T 255/T 265 (24)

14. Moisture content calculated correctly and recorded to the nearest 0.1 percent? \_\_\_\_\_

Comments: First attempt: Pass\_\_\_\_\_Fail\_\_\_\_\_ Second attempt: Pass\_\_\_\_\_Fail\_\_\_\_\_

\_\_\_\_\_  
\_\_\_\_\_  
\_\_\_\_\_  
\_\_\_\_\_

Examiner Signature \_\_\_\_\_ WAQTC #: \_\_\_\_\_



## **ONE-POINT METHOD FOR DETERMINING MAXIMUM DRY DENSITY AND OPTIMUM MOISTURE FOP FOR AASHTO T 272**

### **Scope**

This procedure provides for a rapid determination of the maximum dry density and optimum moisture content of a soil sample, using a one-point determination in accordance with AASHTO T 272-18. This procedure is related to the FOPs for AASHTO T 99/T 180 and R 75.

One-point determinations are made by compacting the soil in a mold of a given size with a specified rammer dropped from a specified height and then compared to an individual moisture-density curve (FOP for AASHTO T 99 or T 180) or soil density-relations group (FOP for AASHTO R 75). Four alternate methods – A, B, C, and D – are used and correspond to the methods described in the FOP for AASHTO T 99/T 180. The method used in AASHTO T 272 must match the method used for the reference curve or to develop the soil density-relations. For example, when moisture-density relationships as determined by T 99 – Method C are used to form the soil density-relations group or an individual moisture density curve, then T 99 – Method C must be used to for the one-point determination.

### **Apparatus**

See the FOP for AASHTO T 99/T 180.

### **Sample**

Sample size determined according to the FOP for AASHTO T 310. In cases where the existing individual curve or soil density-relations group cannot be used a completely new curve will need to be developed and the sample size will be determined by the FOP for AASHTO T 99/T 180.

1. If the sample is damp, dry it until it becomes friable under a trowel. Drying may be in air or by use of a drying apparatus maintained at a temperature not exceeding 60°C (140°F).
2. Thoroughly break up aggregations in a manner that avoids reducing the natural size of individual particles.
3. Pass the material through the appropriate sieve.

### **Procedure**

Use the method matching the individual curve or soil density-relations group. Refer to Table 1 of the FOP for AASHTO T 99 / T 180 for corresponding mold size, number of layers, number of blows, sieve size, and rammer specification for the various test methods.

1. Determine the mass of the clean, dry mold. Include the base plate but exclude the extension collar. Record the mass to the nearest 1 g (0.005 lb).
2. Thoroughly mix the sample with sufficient water to adjust moisture content to 80 to 100 percent of the anticipated optimum moisture.

3. Form a specimen by compacting the prepared soil in the mold (with collar attached) in approximately equal layers. For each layer:
  - a. Spread the loose material uniformly in the mold.

*Note 1:* It is recommended to cover the remaining material with a non-absorbent sheet or damp cloth to minimize loss of moisture.

  - b. Lightly tamp the loose material with the manual rammer or other similar device, this establishes a firm surface.
  - c. Compact each layer with uniformly distributed blows from the rammer.
  - d. Trim down material that has not been compacted and remains adjacent to the walls of the mold and extends above the compacted surface.
4. Remove the extension collar. Avoid shearing off the sample below the top of the mold. The material compacted in the mold should not be over 6 mm (¼ in.) above the top of the mold once the collar has been removed.
5. Trim the compacted soil even with the top of the mold with the beveled side of the straightedge.
6. Clean soil from exterior of the mold and base plate.
7. Determine the mass of the mold and wet soil to the nearest 1 g (0.005 lb).
8. Determine the wet mass of the sample by subtracting the mass in Step 1 from the mass in Step 7.
9. Calculate the wet density ( $\rho_w$ ) as indicated below under “Calculations.”
10. Extrude the material from the mold. For soils and soil-aggregate mixtures, slice vertically through the center and remove one of the cut faces for a representative moisture content sample. For granular materials, a vertical face will not exist. Take a representative sample ensuring that all layers are represented. This sample must meet the sample size requirements of the test method used to determine moisture content.

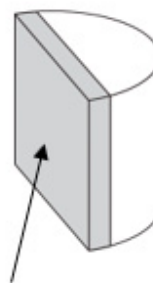
**Extruded material****Representative moisture  
content sample**

11. Determine the moisture content ( $w$ ) of the sample in accordance with the FOP for AASHTO T 255 / T 265.

**Calculations****Wet Density**

$$\rho_w = \frac{M_w}{V_m} = \frac{2.0055 \text{ kg}}{0.0009469 \text{ m}^3} = 2118 \text{ kg/m}^3$$

$$\rho_w = \frac{4.42 \text{ lb}}{0.0334 \text{ ft}^3} = 132.2 \text{ lb/ft}^3$$

$\rho_w$  = wet density, kg/m<sup>3</sup> (lb/ft<sup>3</sup>)

$M_w$  = wet mass

$V_m$  = volume of the mold, (FOP for AASHTO T 99/T 180)

**Dry Density**

$$\rho_d = \left( \frac{\rho_w}{w + 100} \right) \times 100 \quad \text{or} \quad \rho_d = \frac{\rho_w}{\left( \frac{w}{100} \right) + 1}$$

Where:

$\rho_d$  = dry density, kg/m<sup>3</sup> (lb/ft<sup>3</sup>)

w = moisture content, as a percentage

**Example for 4-inch mold, Methods A or C**

Wet mass,  $M_w$  = 2.0055 kg (4.42 lb)

Moisture content, w = 13.5%

Measured volume of the mold,  $V_m$  = 0.0009469 m<sup>3</sup> (0.0334 ft<sup>3</sup>)

**Wet Density**

$$\rho_w = \frac{2.0055 \text{ kg}}{0.0009469 \text{ m}^3} = 2118 \text{ kg/m}^3 \quad \rho_w = \frac{4.42 \text{ lb}}{0.0334 \text{ ft}^3} = 132.2 \text{ lb/ft}^3$$

Where:

$\rho_w$  = Wet density, kg/m<sup>3</sup> (lb/ft<sup>3</sup>)

EMBANKMENT AND BASE  
IN-PLACE DENSITY

WAQTC

FOP AASHTO T 272 (24)

### Dry Density

$$\rho_d = \left( \frac{2118 \text{ kg/m}^3}{13.5 + 100} \right) \times 100 = 1866 \text{ kg/m}^3 \quad \rho_d = \left( \frac{132.2 \text{ lb/ft}^3}{13.5 + 100} \right) \times 100 = 116.5 \text{ lb/ft}^3$$

or

$$\rho_d = \left( \frac{2118 \text{ kg/m}^3}{\frac{13.5}{100} + 1} \right) = 1866 \text{ kg/m}^3 \quad \rho_d = \left( \frac{132.2 \text{ lb/ft}^3}{\frac{13.5}{100} + 1} \right) = 116.5 \text{ lb/ft}^3$$

$$\rho_d = \text{Dry density, kg/m}^3 \text{ (lb/ft}^3\text{)}$$

### Maximum Dry Density and Optimum Moisture Content Determination Using an Individual Moisture - Density Curve

1. The moisture content must be within 80 to 100 percent of optimum moisture of the reference curve. Compact another specimen, using the same material, at an adjusted moisture content if the one-point does not fall in the 80 to 100 percent of optimum moisture range.
2. Plot the one-point, dry density on the vertical axis and moisture content on the horizontal axis, on the reference curve graph.
3. If the one-point falls on the reference curve or within  $\pm 2.0 \text{ lbs/ft}^3$ , use the maximum dry density and optimum moisture content determined by the curve.
4. Use the FOP for AASHTO T 99/T 180 Annex A to determine corrected maximum dry density and optimum moisture content if oversize particles have been removed.
5. Perform a full moisture-density relationship if the one-point does not fall on or within  $\pm 2.0 \text{ lbs/ft}^3$  of the reference curve at 80 to 100 percent optimum moisture.

## Example

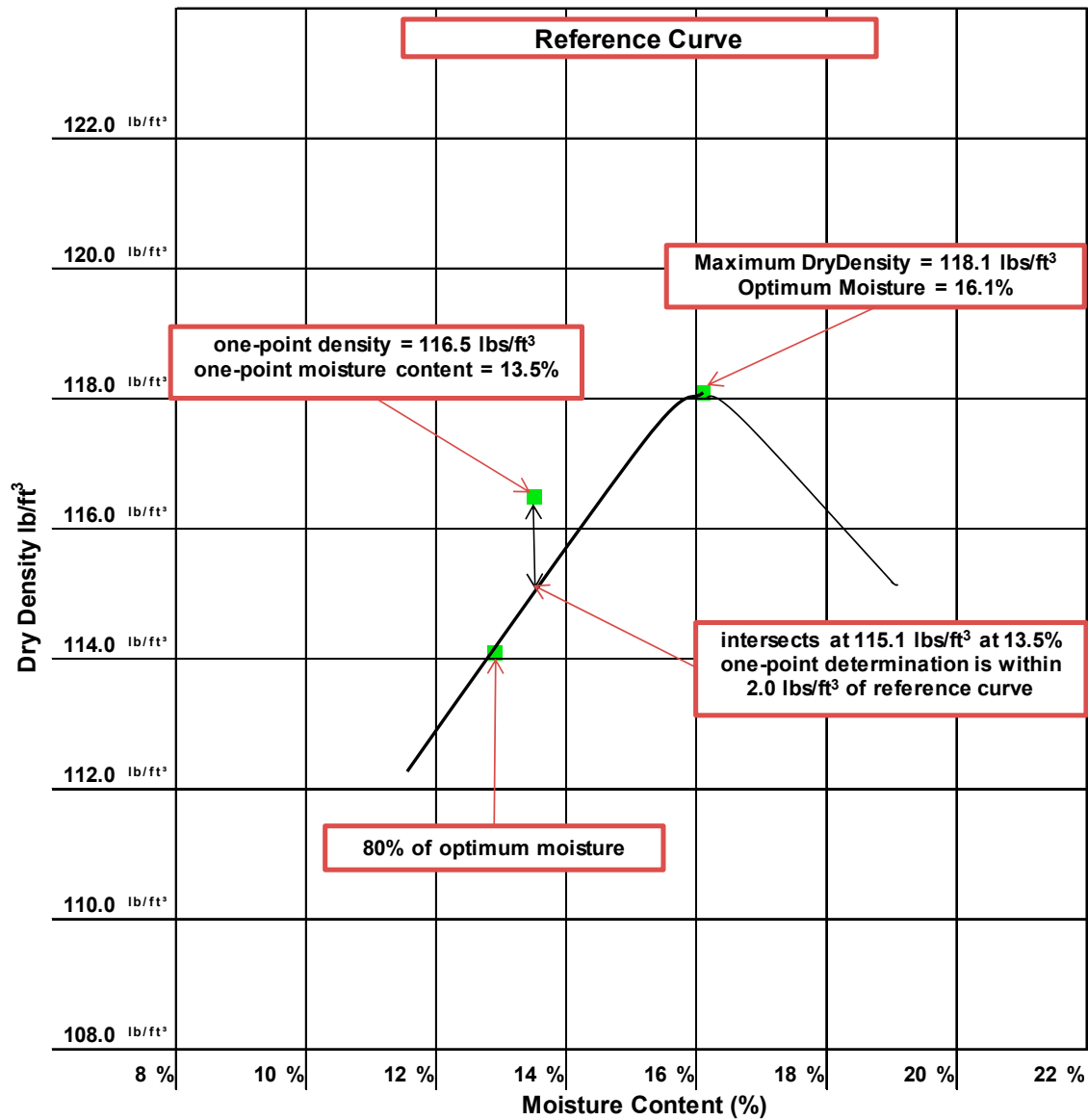

The results of a one-point determination were 116.5 lb/ft<sup>3</sup> at 13.5 percent moisture. The point was plotted on the reference curve graph. The one-point determination is within 2.0 lb/ft<sup>3</sup> of the point on the curve that corresponds with the moisture content.

**Maximum Dry Density and Optimum Moisture Content Determination Using Soil Moisture-Density Relations**

1. Plot the one-point, dry density on the vertical axis and moisture content on the horizontal axis, on the reference soil density-relations graph.
2. If the moisture-density one-point falls on one of the curves in the soil density-relations, use the maximum dry density and optimum moisture content defined by that curve.
3. If the moisture-density one-point falls within the soil density-relations but not on an existing curve, draw a new curve through the plotted single point, parallel and in character with the nearest existing curve in the soil density-relations. Use the maximum dry density and optimum moisture content as defined by the new curve.
  - a. The one-point must fall either between or on the highest or lowest curves. If it does not, then a full curve must be developed.
  - b. If the one-point plotted within or on the soil density-relations group does not fall in the 80 to 100 percent of optimum moisture content, compact another specimen, using the same material, at an adjusted moisture content that will place the one point within this range.
4. Use the FOP for AASHTO T 99/T 180 Annex A to determine corrected maximum dry density and optimum moisture content if oversize particles have been removed.
5. If the new curve through a one-point is not well defined or is in any way questionable, perform a full moisture-density relationship to correctly define the new curve and verify the applicability of the soil density-relations.

**Note 2:** New curves drawn through plotted single point determinations shall not become a permanent part of the soil density-relations until verified by a full moisture-density procedure following the FOP for AASHTO T 99/T 180.

## Example

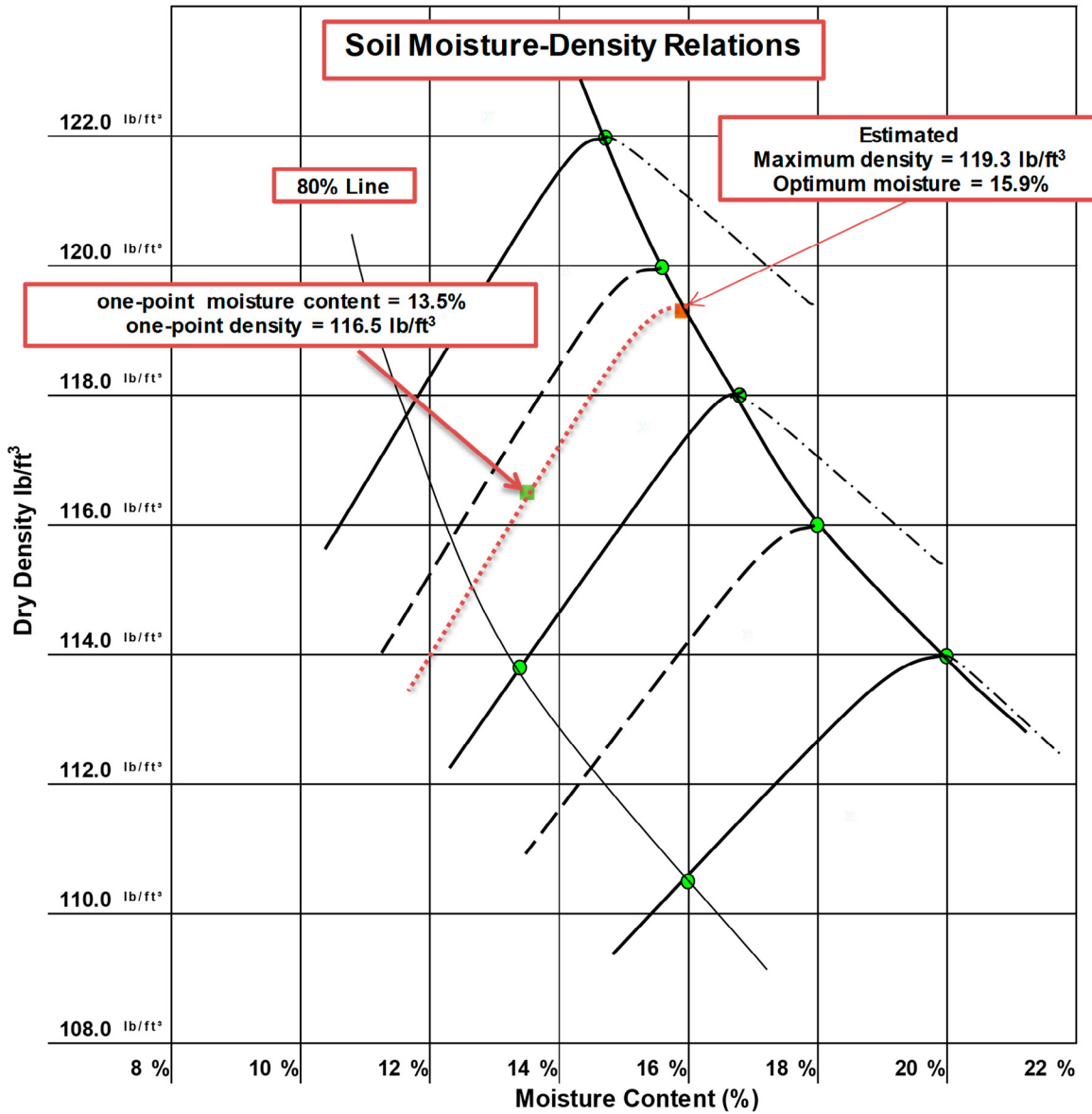

The results of a one-point determination were 116.5 lb/ft<sup>3</sup> at 13.5 percent moisture. The point was plotted on the reference curve graph. The point was plotted on the appropriate group between two previously developed curves near and intermediate curve.

The "dotted" curve through the moisture-density one-point was sketched between the existing curves. A maximum dry density of 119.3 lb/ft<sup>3</sup> and a corresponding optimum moisture content of 15.9 percent were estimated.

EMBANKMENT AND BASE  
IN-PLACE DENSITY

WAQTC

FOP AASHTO T 272 (24)

**Report**

- On forms approved by the agency
- Sample ID
- Maximum dry density to the nearest  $1 \text{ kg/m}^3$  ( $0.1 \text{ lb/ft}^3$ )
- Corrected maximum dry density (if applicable)
- Optimum moisture content to the nearest 0.1 percent
- Corrected optimum moisture content (if applicable)
- Reference curve or Soil Moisture-Density Relations used



**PERFORMANCE EXAM CHECKLIST****ONE-POINT METHOD  
FOP FOR AASHTO T 272 (T 99)**

Participant Name \_\_\_\_\_ Exam Date \_\_\_\_\_

Record the symbols "P" for passing or "F" for failing on each step of the checklist.

Procedure Element	Trial 1	Trial 2
1. One-point determination of dry density and corresponding moisture content made in accordance with the FOP for AASHTO T 99?	_____	_____
a. Correct size (4.75 mm / No. 4 or 19.0 mm / 3/4 in.) material used?	_____	_____
2. If necessary, sample dried until friable in air or drying apparatus, not exceeding 60°C (140°F)?	_____	_____
3. Sample broken up and an adequate amount sieved over the appropriate sieve (4.75 mm / No. 4 or 19.0 mm / 3/4 in.) to determine oversize (coarse particle) percentage?	_____	_____
4. Sample passing the sieve has appropriate mass?	_____	_____
5. Moisture content adjusted if needed?	_____	_____
6. Determine mass of clean, dry mold without collar to nearest 1 g (0.005 lb.)?	_____	_____
7. Mold placed on rigid and stable foundation?	_____	_____
8. Layer of soil (approximately one third compacted depth) placed in mold with collar attached, loose material lightly tamped?	_____	_____
9. Soil compacted with appropriate number of blows (25 or 56)?	_____	_____
10. Material adhering to the inside of the mold trimmed?	_____	_____
11. Layer of soil (approximately two thirds compacted depth) placed in mold with collar attached, loose material lightly tamped?	_____	_____
12. Soil compacted with appropriate number of blows (25 or 56)?	_____	_____
13. Material adhering to the inside of the mold trimmed?	_____	_____
14. Mold filled with soil such that compacted soil will be above the mold, loose material lightly tamped?	_____	_____
15. Soil compacted with appropriate number of blows (25 or 56)?	_____	_____
16. Collar removed without shearing off sample?	_____	_____
17. Approximately 6 mm (1/4 in.) of compacted material above the top of the mold (without the collar)?	_____	_____
18. Soil trimmed to top of mold with the beveled side of the straightedge?	_____	_____
19. Remove soil from exterior surface of mold and base plate?	_____	_____
20. Mass of mold and contents determined to appropriate precision?	_____	_____

**OVER**

EMBANKMENT AND BASE  
IN-PLACE DENSITY

WAQTC

FOP AASHTO T 272 (24)

<b>Procedure Element</b>	<b>Trial 1</b>	<b>Trial 2</b>
21. Wet density calculated from the wet mass?	_____	_____
22. Soil removed from mold using a sample extruder if needed?	_____	_____
23. Soil sliced vertically through center (non-granular material)?	_____	_____
24. Moisture sample removed ensuring all layers are represented?	_____	_____
25. Moist mass determined immediately to 0.1 g?	_____	_____
26. Moisture sample mass of correct size?	_____	_____
27. Sample dried and water content determined according to the FOP for T 255/T 265?	_____	_____
28. One-point plotted on soils moisture-density relations group supplied?	_____	_____
a. One-point falls within 80 to 100 percent of optimum moisture content in order to be valid?	_____	_____
b. If one-point does not fall within 80 to 100 percent of optimum moisture content, another one-point determination with an adjusted water content is made?	_____	_____
c. Maximum dry density and corresponding optimum moisture content correctly estimated?	_____	_____
29. One-point plotted on a single reference curve?	_____	_____
a. Does one-point plot within 2 lb/ft <sup>3</sup> in order to be valid?	_____	_____
b. Does one-point fall within 80 to 100 percent of optimum moisture content in order to be valid?	_____	_____
c. Maximum dry density and corresponding optimum moisture content determined from single reference curve?	_____	_____

Comments:      First attempt: Pass \_\_\_\_\_ Fail \_\_\_\_\_      Second attempt: Pass \_\_\_\_\_ Fail \_\_\_\_\_

\_\_\_\_\_

\_\_\_\_\_

\_\_\_\_\_

\_\_\_\_\_

\_\_\_\_\_

\_\_\_\_\_

\_\_\_\_\_

\_\_\_\_\_

\_\_\_\_\_

\_\_\_\_\_

Examiner Signature \_\_\_\_\_ WAQTC #: \_\_\_\_\_

**PERFORMANCE EXAM CHECKLIST**

**ONE-POINT METHOD  
FOP FOR AASHTO T 272 (T 180)**

Participant Name \_\_\_\_\_ Exam Date \_\_\_\_\_

Record the symbols “P” for passing or “F” for failing on each step of the checklist.

Procedure Element	Trial 1	Trial 2
1. One-point determination of dry density and corresponding moisture content made in accordance with the FOP for AASHTO T 180?	_____	_____
a. Correct size (4.75 mm / No. 4 or 19.0 mm / 3/4 in.) material used?	_____	_____
2. If necessary, sample dried until friable in air or drying apparatus, not exceeding 60°C (140°F)?	_____	_____
3. Sample broken up and an adequate amount sieved over the appropriate sieve (4.75 mm / No. 4 or 19.0 mm / 3/4 in.) to determine oversize (coarse particle) percentage?	_____	_____
4. Sample passing the sieve has appropriate mass?	_____	_____
5. Moisture content adjusted if needed?	_____	_____
6. Determine mass of clean, dry mold without collar to nearest 1 g (0.005 lb.)?	_____	_____
7. Mold placed on rigid and stable foundation?	_____	_____
8. Layer of soil (approximately one fifth compacted depth) placed in mold with collar attached, loose material lightly tamped?	_____	_____
9. Soil compacted with appropriate number of blows (25 or 56)?	_____	_____
10. Material adhering to the inside of the mold trimmed?	_____	_____
11. Layer of soil (approximately two fifths compacted depth) placed in mold with collar attached, loose material lightly tamped?	_____	_____
12. Soil compacted with appropriate number of blows (25 or 56)?	_____	_____
13. Material adhering to the inside of the mold trimmed?	_____	_____
14. Layer of soil (approximately three fifths compacted depth) placed in mold with collar attached, loose material lightly tamped?	_____	_____
15. Soil compacted with appropriate number of blows (25 or 56)?	_____	_____
16. Material adhering to the inside of the mold trimmed?	_____	_____
17. Layer of soil (approximately four fifths compacted depth) placed in mold with collar attached, loose material lightly tamped?	_____	_____
18. Soil compacted with appropriate number of blows (25 or 56)?	_____	_____
19. Material adhering to the inside of the mold trimmed?	_____	_____

**OVER**

**Procedure Element**

**Trial 1 Trial 2**

- 20. Mold filled with soil such that compacted soil will be above the mold, loose material lightly tamped? \_\_\_\_\_ \_\_\_\_\_
- 21. Soil compacted with appropriate number of blows (25 or 56)? \_\_\_\_\_ \_\_\_\_\_
- 22. Collar removed without shearing off sample? \_\_\_\_\_ \_\_\_\_\_
- 23. Approximately 6 mm (1/4 in.) of compacted material above the top of the mold (without the collar)? \_\_\_\_\_ \_\_\_\_\_
- 24. Soil trimmed to top of mold with the beveled side of the straightedge? \_\_\_\_\_ \_\_\_\_\_
- 25. Remove soil from exterior surface of mold and base plate? \_\_\_\_\_ \_\_\_\_\_
- 26. Mass of mold and contents determined to appropriate precision? \_\_\_\_\_ \_\_\_\_\_
- 27. Wet density calculated from the wet mass? \_\_\_\_\_ \_\_\_\_\_
- 28. Soil removed from mold using a sample extruder if needed? \_\_\_\_\_ \_\_\_\_\_
- 29. Soil sliced vertically through center (non-granular material)? \_\_\_\_\_ \_\_\_\_\_
- 30. Moisture sample removed ensuring all layers are represented? \_\_\_\_\_ \_\_\_\_\_
- 31. Moist mass determined immediately to 0.1 g? \_\_\_\_\_ \_\_\_\_\_
- 32. Moisture sample mass of correct size? \_\_\_\_\_ \_\_\_\_\_
- 33. Sample dried and water content determined according to the FOP for T 255/T 265? \_\_\_\_\_ \_\_\_\_\_
- 34. One-point plotted on soils moisture-density relations group supplied? \_\_\_\_\_ \_\_\_\_\_
  - a. One-point falls within 80 to 100 percent of optimum moisture content in order to be valid? \_\_\_\_\_ \_\_\_\_\_
  - b. If one-point does not fall within 80 to 100 percent of optimum moisture content, another one-point determination with an adjusted water content is made? \_\_\_\_\_ \_\_\_\_\_
  - c. Maximum dry density and corresponding optimum moisture content correctly estimated? \_\_\_\_\_ \_\_\_\_\_
- 35. One-point plotted on a single reference curve? \_\_\_\_\_ \_\_\_\_\_
  - a. Does one-point plot within 2 lb/ft<sup>3</sup> in order to be valid? \_\_\_\_\_ \_\_\_\_\_
  - b. Does one-point fall within 80 to 100 percent of optimum moisture content in order to be valid? \_\_\_\_\_ \_\_\_\_\_
  - c. Maximum dry density and corresponding optimum moisture content determined from single reference curve? \_\_\_\_\_ \_\_\_\_\_

Comments: First attempt: Pass\_\_\_\_\_Fail\_\_\_\_\_ Second attempt: Pass\_\_\_\_\_Fail\_\_\_\_\_

\_\_\_\_\_  
\_\_\_\_\_  
\_\_\_\_\_

Examiner Signature \_\_\_\_\_ WAQTC #: \_\_\_\_\_

# Performance Exam Checklist

## AASHTO T 288 Checklist

### *Determining Minimum Laboratory Soil Resistivity*

Participant Name: \_\_\_\_\_ Exam Date: \_\_\_\_\_

Record the symbols "P" for passing or "F" for failing on each step of the checklist.

#### Procedure Element

##### *Laboratory method of Determining Minimum Resistivity*

	<b>Trial 1</b>	<b>Trial 2</b>
1. Sample dried at 140 F, and screened through # 10 sieve?	_____	_____
2. Quartered or split out 1500 grams of passing #10 material?	_____	_____
3. 150 ml of distilled water added to the 1500 gram and thoroughly mixed?	_____	_____
4. Sample covered with a wet cloth and allow to stabilize or cure for 12 hours?	_____	_____
5. Sample placed & compacted in soil box in layers and the excess trimmed off with a straightedge?	_____	_____
6. Resistivity measured with the instrument?	_____	_____
7. Soil removed and retained from box and 100 ml of distilled water added and thoroughly mixed?	_____	_____
8. Soil box cleaned with distilled water?	_____	_____
9. Repeat procedure by increasing moisture content by 100 ml until minimum resistivity can be established?	_____	_____
10. Record the lowest value during the repeated measurements?	_____	_____
11. Report the resistivity reading.	_____	_____

Comments: First Attempt: Pass \_\_\_\_\_ Fail \_\_\_\_\_ Second Attempt: Pass \_\_\_\_\_ Fail \_\_\_\_\_

Examiner Signature: \_\_\_\_\_ WAQTC #: \_\_\_\_\_



## **WSDOT Errata to FOP for AASHTO T 304**

### ***Uncompacted Void Content of Fine Aggregate***

WAQTC FOP for AASHTO T 304 has been adopted by WSDOT with the following changes:

#### **Report**

*Replace first bullet with below:*

- The Uncompacted Voids ( $U_m$ ) in percent to the nearest 1 percent.





## UNCOMPACTED VOID CONTENT OF FINE AGGREGATE FOP FOR AASHTO T 304

### Scope

This procedure covers the determination of the loose uncompacted void content of a sample of fine aggregate in accordance with AASHTO T 304-22. When measured on an aggregate of a known grading, void content indicates the aggregate's angularity, sphericity, and surface texture compared with other fine aggregates tested in the same grading. When void content is measured on an as-received fine aggregate grading, it can indicate the effect of the fine aggregate on the workability of a mixture in which it is used.

### Apparatus

- Cylindrical Measure – approximately 100 mL right cylinder made of seamless smooth wall metal, inside diameter approximately 39 mm and inside height approximately 86 mm, with a metal bottom at least 6 mm thick, which is firmly sealed to the cylinder with means for aligning the axis of the cylinder with that of the funnel (see Figure 1).
- Funnel – the lateral surface of the right frustum of a smooth metal cone at least 38 mm high sloped  $60 \pm 4$  degrees from the horizontal with an opening of  $12.7 \pm 0.6$  mm diameter with a volume of at least 200 mL or with a supplemental glass or metal container to provide the required volume (see Figure 2).
- Funnel Stand – A three or four-legged support capable of holding the funnel firmly in position  $115 \pm 2$  mm above the top of the cylinder with the axis of the funnel colinear (within a 4 degree angle and a displacement of 2 mm) with the axis of the cylindrical measure. A suitable arrangement is shown in Figure 2.
- Glass Plate – minimum 4 mm thick, approximately 60 mm by 60 mm used to calibrate the cylindrical measure.
- Pan – flat metal or plastic pan of sufficient size to contain the funnel stand and to prevent loss of material.
- Metal spatula with a straight edged blade approximately 100 mm long, and at least 20 mm wide with an end cut at a right angle to the edges.
- Scale or balance accurate and readable to  $\pm 0.1$  g within the range of use, capable of weighing the cylindrical measure and its contents.

**Figure 1**

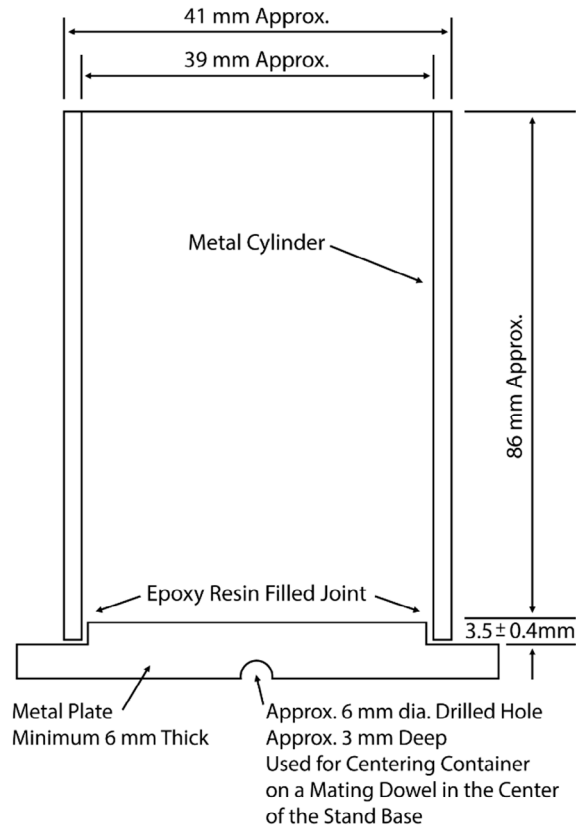

**Figure 2**

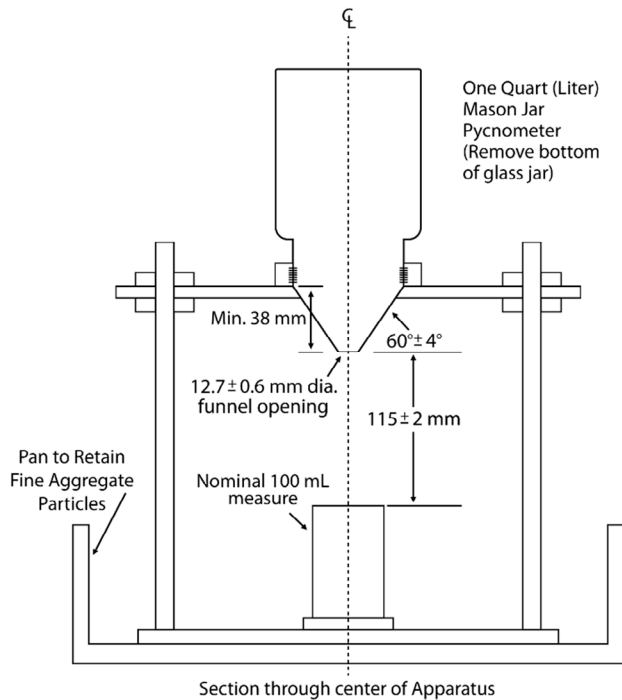

### Preparation of Test Samples

Obtain the standard graded sample from one of the following:

1. Use the sieve analysis samples from the FOP for AASHTO T 27/11.
2. Store the dry separate size fractions obtained from one (or more) sieve analysis in separate containers for each size.

OR:

1. Obtain sample according to the FOP for AASHTO R 90
2. Reduce according to the FOP for AASHTO R 76
3. Wash sample over a 150- $\mu$ m (No. 100) or 75- $\mu$ m (No. 200) sieve according to FOP for AASHTO T 27/11.
4. Dry to constant mass according to the FOP for AASHTO T 255.
5. Using sieves in Table 1, separate into individual size fractions according to FOP for AASHTO T 27/11
6. Weigh out and combine the following quantities of material identified in Table 1.

**Table 1**

<b>Individual Size Fraction</b>		
<b>Passing</b>	<b>Retained On</b>	<b>Mass g</b>
No. 8 (2.36 mm)	No. 16 (1.18 mm)	44.0 $\pm$ 0.2
No. 16 (1.18 mm)	No. 30 (600 $\mu$ m)	57.0 $\pm$ 0.2
No. 30 (600 $\mu$ m)	No. 50 (300 $\mu$ m)	72.0 $\pm$ 0.2
No. 50 (300 $\mu$ m)	No. 100 (150 $\mu$ m)	17.0 $\pm$ 0.2
	Total	190.0 $\pm$ 0.2

## Specific Gravity of Fine Aggregate

The fine aggregate bulk specific gravity ( $G_{sb}$ ) is used to determine the uncompacted void content. Use the  $G_{sb}$  from the source if it is known. If it is unknown determine the  $G_{sb}$  on the minus No. 4 (4.75 mm) material according to AASHTO T 84.

If the  $G_{sb}$  of some size fractions differ by more than 0.05 from the  $G_{sb}$  typical of the complete sample, the  $G_{sb}$  of the fraction (or fractions) being tested must be determined.

**Note 1:** An indicator of differences in specific gravity of various particle sizes is a comparison of specific gravities run on the fine aggregate in different gradings. Specific gravity can be run on gradings with and without specific size fractions of interest. If specific gravity differences exceed 0.05, determine the specific gravity of the individual 2.36 mm (No. 8) to 150  $\mu$ m (No. 100) sizes for use either by direct measurement or by calculation using the specific gravity data on gradings with and without the size fraction of interest. A difference in specific gravity of 0.05 will change the calculated void content about 1 percent.

### Procedure

1. Record the mass of the empty measure to the nearest 0.1 g.
2. Mix test sample with the spatula until it appears to be homogeneous.
3. Position the jar and funnel section in the stand and center the cylindrical measure as shown in Figure 2.
4. Using a finger, block the opening of the funnel, pour the test sample into the funnel.
5. Level the material in the funnel with the spatula.
6. Withdraw finger allowing the sample to freely flow into the cylindrical measure.
7. After the funnel empties, strike-off excess fine aggregate from the cylindrical measure with a rapid single pass of the spatula with the width of the blade vertical using the straight part of its edge in light contact with the top of the measure.

Until strike-off is complete, avoid vibration or disturbance which could cause compaction of the material in the measure.

**Note 2:** After strike-off, the cylindrical measure may be tapped lightly to compact the sample to make it easier to transfer the container to scale or balance without spilling any of the sample.

8. Brush adhering grains from the outside of the container.
9. Determine and record the mass of the cylindrical measure and contents to the nearest 0.1 g.
10. Recombine the sample from the pan and cylindrical measure.
11. Stir until homogenous.
12. Repeat Steps 3 through 9.
13. Determine net mass of aggregate in measure by subtracting mass of the measure from the mass of measure and fine aggregate.
14. Calculate the uncompacted void content ( $U_s$ ) of each determination to the nearest 0.1 percent.
15. Average the results of the two determinations ( $U_m$ ) to the nearest 0.1 percent.

**Calculations**

**Calculate the uncompacted voids for each determination:**

$$U_s = \frac{V - \left(\frac{F}{G_{sb}}\right)}{V} \times 100$$

Where:

$U_s$  = uncompacted voids in the material to the nearest 0.1 percent

$V$  = volume of cylindrical measure, mL

$F$  = net mass, g, of fine aggregate in measure

$G_{sb}$  = Bulk dry specific gravity of fine aggregate

**Calculate the average uncompacted voids for the two determinations:**

$$U_m = \frac{U_1 + U_2}{2}$$

Where:

$U_m$  = the average uncompacted void content to the nearest 0.1 percent

$U_1$  = first determination

$U_2$  = second determination

**Example:**

$$U_s = \frac{99.8 \text{ mL} - \left(\frac{146.2 \text{ g}}{2.636}\right)}{99.8 \text{ mL}} \times 100 = 44.4\%$$

Where:

$U_s$  = uncompacted voids in the material to the nearest 0.1 percent

$V$  = 99.8 mL

$F$  = 146.2 g

$G_{sb}$  = 2.636

The average uncompacted voids for the two determinations:

$$U_m = \frac{48.7\% + 49.9\%}{2} = 49.3\%$$

Where:

$U_m$  = the average uncompacted void content to the nearest 0.1 percent

$U_1$  = 48.7%

$U_2$  = 49.9%

## Report

- The Uncompacted Voids ( $U_m$ ) in percent to the nearest 0.1 percent.
- The specific gravity value used in the calculations.

**ANNEX — CALIBRATION OF CYLINDRICAL MEASURE**

(Mandatory Information)

1. Apply a light coat of grease to the top edge of the dry, empty cylindrical measure.
2. Determine the mass of the measure, grease, and glass plate to the nearest 0.1 g.
3. Fill the measure with freshly boiled, deionized water at a temperature of 18 to 24°C (64.4 to 75.2°F).
4. Record the temperature of the water.
5. Place the glass plate on the measure, being sure that no air bubbles remain.
6. Dry the outer surfaces of the measure.
7. Determine the combined mass of measure, glass plate, grease, and water to the nearest 0.1 g.

**Calculations**

Calculate the volume of the measure as follows:

$$V = 1000 \times \frac{M}{D}$$

Where:

- V = volume of cylinder, to the nearest 0.1 mL  
M = net mass of water, g  
D = density of water kg/m<sup>3</sup> (see Table B1 in the FOP for AASHTO T 99/T 180 for density at the temperature used)

**Example**

$$V = 1000 \times \frac{99.6}{997.99} = 99.8 \text{ mL}$$

Where:

- V = volume of cylinder, to the nearest 0.1 mL  
M = 99.6 g  
D = 997.99 kg/m<sup>3</sup>, density of water at 21°C (69.8°F)





**PERFORMANCE EXAM CHECKLIST**

**UNCOMPACTED VOID CONTENT OF FINE AGGREGATE  
FOP FOR AASHTO T 304**

**Participant Name** \_\_\_\_\_ **Exam Date** \_\_\_\_\_

Record the symbols “P” for passing or “F” for failing on each step of the checklist.

<b>Procedure Element</b>	<b>Trial 1</b>	<b>Trial 2</b>
1. Sample obtained according to FOP for AASHTO R 90?	_____	_____
2. Sample reduced according to the FOP for AASHTO R 76?	_____	_____
3. Sample washed over 150 μm (No. 100) or 75 μm (No. 200)?	_____	_____
4. Sample dried to constant mass?	_____	_____
5. Sample separated into individual size fractions?	_____	_____
6. Material weighed out and combined according to Table 1?	_____	_____
7. G <sub>sb</sub> obtained or determined?	_____	_____
8. Calibrated measure used?	_____	_____
9. Mass of empty measure determined?	_____	_____
10. Test sample mixed until it appears homogeneous?	_____	_____
11. Measure centered on stand?	_____	_____
12. Funnel opening blocked with finger?	_____	_____
13. Test sample poured in funnel and leveled with spatula?	_____	_____
14. Finger withdrawn and sample allowed to freely flow into cylindrical measure?	_____	_____
15. Excess material struck off with spatula correctly?	_____	_____
16. Vibration or disturbance avoided?	_____	_____
17. Adhering grains brushed off?	_____	_____
18. Mass of the cylindrical measure and contents determined to nearest 0.1 g?	_____	_____
19. Sample recombined and stirred until homogenous?	_____	_____
20. Procedure repeated?	_____	_____
21. Results calculated and reported correctly?	_____	_____

**Comments:** First attempt: Pass \_\_\_\_\_ Fail \_\_\_\_\_ Second attempt: Pass \_\_\_\_\_ Fail \_\_\_\_\_

\_\_\_\_\_

\_\_\_\_\_

\_\_\_\_\_

Examiner Signature \_\_\_\_\_ WAQTC #: \_\_\_\_\_



## **WSDOT Errata to FOP for AASHTO T 308**

### ***Determining the Asphalt Binder Content of Asphalt Mixtures by the Ignition Method***

WAQTC FOP for AASHTO T 308 has been adopted by WSDOT with the following changes:

#### **Procedure – Method A (Internal Balance)**

*Replace step 4 with below:*

4. Determine and record the total mass of the sample and sample basket assembly to the nearest 0.1 g.

**Procedure – Method B (External Balance) – *Method not recognized by WSDOT.***

#### **Annex – Correction Factors**

##### **Asphalt Binder and Aggregate**

**Asphalt binder correction factor – *Shall read as below:***

A correction factor must be established by testing a set of correction specimens for each Job Mix Formula (JMF).

**Aggregate correction factor – *Method not recognized by WSDOT.***

##### **Procedure**

*Steps 10 – 14 not recognized by WSDOT.*



## DETERMINING THE ASPHALT BINDER CONTENT OF ASPHALT MIXTURES BY THE IGNITION METHOD FOP FOR AASHTO T 308

### Scope

This procedure covers the determination of asphalt binder content of asphalt mixtures by ignition of the binder in accordance with AASHTO T 308-24.

### Overview

The sample is heated in a furnace at 538°C (1000°F) or less; samples may be heated by convection or direct infrared irradiation (IR). The aggregate remaining after burning can be used for sieve analysis using the FOP for AASHTO T 30.

Some agencies allow the use of recycled asphalt mixtures. When using recycled asphalt mixtures, check with the agency for specific correction procedures.

Asphalt binder in the asphalt mixture is ignited in a furnace. Asphalt binder content is calculated as the percentage difference between the initial mass of the asphalt mixture and the mass of the residual aggregate, with the asphalt binder correction factor, and moisture content subtracted. The asphalt binder content is expressed as a percent of moisture-free mix mass.

Two methods, A and B, are presented.

### Apparatus

*Note 1:* The apparatus must be calibrated for the specific mix design. See “Correction Factors” at the end of this FOP.

The apparatus for Methods A and B is the same except that the furnace for Method A requires an internal balance.

- **Ignition Furnace:** A forced-air ignition furnace that heats the specimens by either the convection or direct IR irradiation method. The convection-type furnace must be capable of maintaining the temperature between at least 530 and 545°C (986 and 1013°F) and have a temperature control accurate within  $\pm 5^{\circ}\text{C}$  ( $\pm 9^{\circ}\text{F}$ ).

For Method A, the furnace will be equipped with an internal scale thermally isolated from the furnace chamber and accurate to 0.1 g. The scale shall be capable of determining the mass of a 3500 g sample in addition to the sample baskets. A data collection system will be included so that mass can be automatically determined and displayed during the test. The furnace shall have a built-in computer program to calculate the change in mass of the sample and provide for the input of a correction factor for aggregate loss. The furnace shall provide a printed ticket with the initial specimen mass, specimen mass loss, temperature compensation, correction factor, corrected asphalt binder content, test time, and test temperature. The furnace shall provide an audible alarm and indicator light when the sample mass loss does not exceed 0.01 percent of the total sample mass for three consecutive minutes. Perform lift test according to manufacturer’s instructions weekly during use, if applicable. The furnace shall be

designed to permit the operator to change the ending mass loss percentage from both 0.01 percent to 0.02 percent.

For both Method A and Method B, the furnace chamber dimensions shall be adequate to accommodate a 3500 g sample. The furnace door shall be equipped so that it cannot be opened during the ignition test. A method for reducing furnace emissions shall be provided and the furnace shall be vented so that no emissions escape into the laboratory. The furnace shall have a fan to pull air through the furnace to expedite the test and to eliminate the escape of smoke into the laboratory.

- **Sample Basket Assembly:** consisting of sample basket(s), catch pan, and basket guards. Sample basket(s) will be of appropriate size allowing samples to be thinly spread and allowing air to flow through and around the sample particles. Sets of two or more baskets shall be nested. A catch pan: of sufficient size to hold the sample basket(s) so that aggregate particles and melting asphalt binder falling through the screen mesh are caught. Basket guards will completely enclose the basket and be made of screen mesh, perforated stainless steel plate, or other suitable material.
- Thermometer, or other temperature measuring device, with a temperature range of 10 - 260°C (50-500°F).
- Oven capable of maintaining 110 ±5°C (230 ±9°F).
- Balance or scale: Capacity sufficient for the sample mass and conforming to the requirements of M 231, Class G2.
- **Safety equipment:** Safety glasses or face shield, high temperature gloves, long sleeved jacket, a heat resistant surface capable of withstanding 650°C (1202°F), a protective cage capable of surrounding the sample baskets during the cooling period, and a particle mask for use during removal of the sample from the basket assembly.
- Miscellaneous equipment: A container larger than the sample basket(s) for transferring sample after ignition, large flat pan, spatulas, bowls, and wire brushes.

### Sample Preparation

1. Obtain samples of asphalt mixture in accordance with the FOP for AASHTO R 97.
2. If the mixture is not sufficiently soft to separate with a spatula or trowel, place it in a large flat pan in an oven at 110 ±5°C (230 ±9°F) until workable.
3. Reduce asphalt mixture samples in accordance with the FOP for AASHTO R 47.
4. Test sample size shall conform to the mass requirement shown in Table 1.

**Note 2:** When the mass of the test specimen exceeds the capacity of the equipment used or for large samples of fine mixes, the test specimen may be divided into suitable increments, tested, and the results appropriately combined through a weighted average for calculation of the asphalt binder content.

Table 1

Nominal Maximum Aggregate Size* mm (in.)	Minimum Mass Specimen g	Maximum Mass Specimen g
37.5 (1 ½)	4000	4500
25.0 (1)	3000	3500
19.0 (¾)	2000	2500
12.5 (½)	1500	2000
9.5 (¾)	1200	1700
4.75 (No. 4)	1200	1700

\* One sieve larger than the first sieve to retain more than 10 percent of the material using an agency specified set of sieves based on cumulative percent retained. Where large gaps in specification sieves exist, intermediate sieve(s) may be inserted to determine nominal maximum size.

### General

1. For the convection-type furnace, preheat the ignition furnace to  $538 \pm 5^{\circ}\text{C}$  ( $1000 \pm 9^{\circ}\text{F}$ ) or to the temperature determined in the Correction Factors Annex of this method. Manually record the furnace temperature (set point) before the initiation of the test if the furnace does not record automatically. For the direct IR irradiation-type furnace, use the same burn profile as used during the correction factor determination.

### Procedure – Method A (Internal Balance)

1. Dry the sample to constant mass, according to the FOP for AASHTO T 329; or determine the moisture content of a companion sample in accordance with the FOP for AASHTO T 329.
2. Determine and record the mass of the sample basket assembly to the nearest 0.1 g.
3. Evenly distribute the sample in the sample basket assembly, taking care to keep the material away from the edges of the basket. Use a spatula or trowel to level the sample.
4. Determine and record the total mass of the sample and sample basket assembly at room temperature to the nearest 0.1 g.
5. Calculate the initial mass of the sample by subtracting the mass of the sample basket from the mass of the sample and sample basket assembly and record to the nearest 0.1 g. Designate this mass as ( $M_i$ ).
6. Record the correction factor or input into the furnace controller for the specific asphalt mixture.

7. Input the initial mass of the sample ( $M_i$ ) into the ignition furnace controller. Verify that the correct mass has been entered.
8. Verify the furnace scale is reading zero, if not, reset to zero.

**CAUTION:** Operator should wear safety equipment – high temperature gloves, face shield, fire-retardant shop coat – when opening the door to load or unload the sample.

9. Open the chamber door and gently set the sample basket assembly in the furnace. Carefully position the sample basket assembly so it is not in contact with the furnace wall. Close the chamber door and verify that the sample mass displayed on the furnace scale equals the total mass of the sample and sample basket assembly recorded in Step 5 within  $\pm 5$  g.

**Note 3:** Differences greater than 5 g or failure of the furnace scale to stabilize may indicate that the specimen basket assembly is contacting the furnace wall.

**Note 4:** Furnace temperature will drop below the set point when the door is opened but will recover when the door is closed, and ignition begins. Sample ignition typically increases the temperature well above the set point – relative to sample size and asphalt binder content.

10. Initiate the test by pressing the start button. This will lock the sample chamber and start the combustion blower.

**Safety note:** Do not attempt to open the furnace door until the asphalt binder has been completely burned off.

11. Allow the test to continue until the stable light and audible stable indicator indicate that the change in mass does not exceed 0.01 percent for three consecutive minutes. Press the stop button. This will unlock the sample chamber and cause the printer to print out the test results.

**Note 5:** An ending mass loss percentage of 0.02 may be used, if allowed by the agency, when aggregate that exhibits an excessive amount of loss during ignition testing is used.

12. Open the chamber door, remove the sample basket assembly, and place on the cooling plate or block. Place the protective cage over the sample basket assembly and allow it to cool to room temperature (approximately 30 minutes).
13. Determine and record the mass of the sample and sample basket assembly after ignition to the nearest 0.1 g.
14. Calculate the mass of the sample by subtracting the mass of the sample basket assembly from the mass of the sample and sample basket assembly and record to the nearest 0.1 g. Designate this mass as  $M_f$ .
15. Use the asphalt binder content percentage from the printed ticket. Subtract the moisture content and the correction factor if not entered into the furnace controller from the printed ticket asphalt binder content and report the difference as the corrected asphalt binder content.

Asphalt binder content percentage can also be calculated using the formula from “Method B” Step 16.



## Calculation

### Corrected asphalt binder content:

$$P_b = BC - MC - C_f^*$$

\*If correction factor is not entered into the furnace controller

where:

$P_b$  = the corrected asphalt binder content as a percent by mass of the asphalt mixture

BC = asphalt binder content shown on printed ticket

MC = moisture content of the companion asphalt mixture sample, percent, as determined by the FOP for AASHTO T 329 (if the specimen was oven-dried before initiating the procedure, MC=0)

$C_f$  = correction factor as a percent by mass of the asphalt mixture sample

### Procedure – Method B (External Balance)

1. Dry the sample to constant mass, according to the FOP for AASHTO T 329; or determine the moisture content of a companion sample in accordance with the FOP for AASHTO T 329.
2. Determine and record the mass of the sample basket assembly to the nearest 0.1 g.
3. Place the sample basket(s) in the catch pan. Evenly distribute the sample in the sample basket(s), taking care to keep the material away from the edges of the basket. Use a spatula or trowel to level the sample.
4. Determine and record the mass of the sample and sample basket assembly at room temperature to the nearest 0.1 g.
5. Calculate the initial mass of the sample by subtracting the mass of the sample basket from the mass of the sample and sample basket assembly and record to the nearest 0.1 g. Designate this mass as ( $M_i$ ).
6. Record the correction factor for the specific asphalt mixture.
7. Open the chamber door and gently set the sample basket assembly in the furnace. Carefully position the sample basket assembly so it is not in contact with the furnace wall. Burn the asphalt mixture sample in the furnace for 45 minutes or the length of time determined in the “Correction Factors” section.
8. Open the chamber door, remove the sample basket assembly, and place on the cooling plate or block. Place the protective cage over the sample and allow it to cool to room temperature (approximately 30 min).

9. Determine and record the mass of the sample and sample basket assembly to the nearest 0.1 g.
10. Calculate the sample mass by subtracting the mass of the sample basket assembly from the mass of the sample and sample basket assembly and record to the nearest 0.1 g.
11. Place the sample basket assembly back into the furnace.
12. Burn the sample for at least 15 minutes after the furnace reaches the set temperature.
13. Open the chamber door, remove the sample basket assembly, and place on the cooling plate or block. Place the protective cage over the sample basket assembly and allow it to cool to room temperature (approximately 30 min.).
14. Determine and record the mass of the sample and sample basket assembly to the nearest 0.1 g.
15. Calculate the mass of the sample by subtracting the mass of the sample basket assembly from the mass of the sample and sample basket assembly and record to the nearest 0.1 g.
16. Determine percent change by subtracting the new mass determination ( $M_n$ ) from the previous mass determination ( $M_p$ ), dividing by the previous mass determination ( $M_p$ ), and multiplying by 100.
17. If the percent change exceeds 0.01 percent of the previous sample mass, repeat Steps 11 through 16 until the percent change does not exceed 0.01 percent.  
*Note 6:* An ending mass loss percentage of 0.02 may be used, if allowed by the agency, when aggregate that exhibits an excessive amount of loss during ignition testing is used.
18. Determine and record the mass of the sample and sample basket assembly to the nearest 0.1 g.
19. Calculate the final sample mass by subtracting the mass of the sample basket assembly and sample and sample basket assembly and record to the nearest 0.1 g. Designate this mass as  $M_f$ .
20. Calculate the asphalt binder content of the sample.

ASPHALT

WAQTC

FOP AASHTO T 308 (24)

**Calculations****Constant Mass**

Calculate %change:

$$\% \text{ Change} = \frac{M_p - M_n}{M_p} \times 100$$

where:

 $M_p$  = sample mass after ignition $M_n$  = sample mass after 15 min. additional ignition**Example**

Initial mass of sample and basket	= 5292.7 g
Mass of basket assembly	= 2931.5 g
$M_i$	= 2361.2 g
Sample mass and basket after first ignition	= 5154.4 g
Sample mass after first ignition	= 2222.9 g
Sample mass and basket after additional 15 min ignition	= 5154.2 g

**Constant mass**

Sample mass after additional 15 min ignition = 2222.7 g

$$\% \text{ change} = \frac{2222.9 \text{ g} - 2222.7 \text{ g}}{2222.9 \text{ g}} \times 100 = 0.009\%$$

%change is not greater than 0.01 percent, so  $M_f =$  2222.7 g

**Percent asphalt binder ( $P_b$ )**

Calculate the asphalt binder content of the sample as follows:

$$P_b = \frac{M_i - M_f}{M_i} \times 100 - MC - C_f$$

where:

- $P_b$  = the corrected asphalt binder content as a percent by mass of the asphalt mixture sample
- $M_f$  = the final sample mass after ignition, g
- $M_i$  = the initial mass of the asphalt mixture sample before ignition, g
- MC = moisture content of the companion asphalt mixture sample, percent, as determined by the FOP for AASHTO T 329 (if the specimen was oven-dried before initiating the procedure, MC = 0).
- $C_f$  = correction factor as a percent by mass of the asphalt mixture sample

**Example**

Correction factor	= 0.42%
Moisture content	= 0.04%
Initial mass of sample and basket	= 5292.7 g
Mass of basket assembly	= 2931.5 g
$M_i$	= 2361.2 g
$M_f$	= 2222.7 g

$$P_b = \frac{2361.2 \text{ g} - 2222.7 \text{ g}}{2361.2 \text{ g}} \times 100 - 0.04\% - 0.42\% = 5.41\%$$

$$P_b = 5.41\%$$

## Gradation

1. Empty contents of the basket(s) into a container, being careful to capture all material. Use a small wire brush to ensure all residual fines are removed from the baskets.

*Note 7:* Particle masks are a recommended safety precaution.

2. Perform the gradation analysis in accordance with the FOP for AASHTO T 30.

## Report

- On forms approved by the agency
- Sample ID
- Method of test (A or B)
- Corrected asphalt binder content,  $P_b$ , to the nearest 0.01 percent or per agency standard
- Correction factor,  $C_f$ , to the nearest 0.01 percent
- Temperature compensation factor (Method A only)
- Total percent loss
- Sample mass
- Moisture content to the nearest 0.01%
- Test temperature

Attach the original printed ticket with all intermediate values (continuous tape) to the report for furnaces with internal balances.

ASPHALT

WAQTC

FOP AASHTO T 308 (24)

---

## ANNEX – CORRECTION FACTORS

### ASPHALT BINDER AND AGGREGATE

(Mandatory Information)

Asphalt binder content results may be affected by the type of aggregate in the mixture and by the ignition furnace. Asphalt binder and aggregate correction factors must, therefore, be established by testing a set of correction specimens for each Job Mix Formula (JMF) mix design. Each ignition furnace will have its own unique correction factor determined in the location where testing will be performed.

This procedure must be performed before any acceptance testing is completed, and repeated each time there is a change in the mix ingredients or design. Any changes greater than 5 percent in stockpiled aggregate proportions should require a new correction factor.

All correction samples will be prepared by a central / regional laboratory unless otherwise directed.

**Asphalt binder correction factor:** A correction factor must be established by testing a set of correction specimens for each Job Mix Formula (JMF). Certain aggregate types may result in unusually high correction factors (> 1.00 percent). Such mixes should be corrected and tested at a lower temperature as described below.

**Aggregate correction factor:** Due to potential aggregate breakdown during the ignition process, a correction factor will need to be determined for the following conditions:

- a. Aggregates that have a proven history of excessive breakdown
- b. Aggregate from an unknown source.

This correction factor will be used to adjust the acceptance gradation test results obtained according to the FOP for AASHTO T 30.

### Procedure

1. Obtain samples of aggregate in accordance with the FOP for AASHTO R 90.
2. Obtain samples of asphalt binder in accordance with the FOP for AASHTO R 66.  
*Note 8:* Include other additives that may be required by the JMF.
3. Prepare an initial, or “butter,” mix at the design asphalt binder content. Mix and discard the butter mix before mixing any of the correction specimens to ensure accurate asphalt content.
4. Prepare two correction specimens at the JMF design asphalt binder content. Aggregate used for correction specimens shall be sampled from material designated for use on the project. An agency approved method will be used to combine aggregate. An additional “blank” specimen shall be batched and tested for aggregate gradation in accordance with the FOP for AASHTO T 30. The gradation from the “blank” shall fall within the agency specified mix design tolerances.
5. Place the freshly mixed specimens directly into the sample basket assembly. If mixed specimens are allowed to cool before placement in the sample basket assembly, the

specimens must be dried to constant mass according to the FOP for AASHTO T 329. Do not preheat the sample basket assembly.

6. Test the specimens in accordance with Method A or Method B of the procedure.
7. Once both correction specimens have been burned, determine the asphalt binder content for each specimen by calculation or from the printed ignition furnace tickets, if available.
8. Calculate the difference between asphalt binder contents of the two specimens:
  - a. If the difference between the asphalt binder contents of the two specimens does not exceed 0.15 percent, use these two results to determine the correction factor.
  - b. If the difference between the asphalt binder contents of the two specimens exceeds 0.15 percent, repeat with two more specimens and, from the four results, discard the high and low results. Determine the correction factor from the two remaining results.
9. Calculate the difference between the actual and measured asphalt binder contents to 0.01 percent. The asphalt binder correction factor,  $C_f$ , is the average of the differences expressed as a percent by mass of asphalt mixture.
10. If the asphalt binder correction factor exceeds 1.00 percent, the test temperature must be lowered to  $482 \pm 5^\circ\text{C}$  ( $900 \pm 9^\circ\text{F}$ ) and new samples must be burned. If the correction factor is the same or higher at the lower temperature, it is permissible to use the higher temperature. The temperature for determining the asphalt binder content of asphalt mixture samples by this procedure shall be the same temperature determined for the correction samples.
11. For the direct IR irradiation-type burn furnaces, the **default** burn profile should be used for most materials. The operator may select burn-profile Option 1 or Option 2 to optimize the burn cycle. The burn profile for testing asphalt mixture samples shall be the same burn profile selected for correction samples.

**Option 1** is designed for aggregate that requires a large asphalt binder correction factor (greater than 1.00 percent) – typically very soft aggregate (such as dolomite).

**Option 2** is designed for samples that may not burn completely using the **default** burn profile.
12. Perform a gradation analysis on the residual aggregate in accordance with the FOP for AASHTO T 30, if required. The results will be utilized in developing an “Aggregate Correction Factor” and should be calculated and reported to 0.1 percent.
13. From the gradation results subtract the percent passing for each sieve, for each sample, from the percent passing each sieve of the “Blank” specimen gradation results from Step 4.
14. Determine the average difference of the two values. If the difference for any single sieve exceeds the allowable difference of that sieve as listed in Table 2, then aggregate gradation correction factors (equal to the resultant average differences) for all sieves shall be applied to all acceptance gradation test results determined by the FOP for AASHTO T 30. If the 75  $\mu\text{m}$  (No. 200) is the only sieve outside the limits in Table 2, apply the aggregate correction factor to only the 75  $\mu\text{m}$  (No. 200) sieve.



**Table 2**  
**Permitted Sieving Difference**

Sieve	Allowable Difference
Sizes larger than or equal to 2.36 mm (No.8)	± 5.0%
Sizes larger than to 75 µm (No.200) and smaller than 2.36 mm (No.8)	± 3.0%
Sizes 75 µm (No.200) and smaller	± 0.5%

**Examples:**

Sieve Size mm (in.)	Correction Factor Blank Sample % Passing	Correction Factor Sample #1 % Passing	Correction Factor Sample #2 % Passing	Difference 1 / 2	Avg. Diff.	Sieves to adjust
19.0 (3/4)	100	100	100	0/0	0.0	
12.5 (1/2)	86.3	87.4	86.4	-1.1/-0.1	-0.6	
9.5 (3/8)	77.4	76.5	78.8	+0.9/-1.4	-0.3	
4.75 (No. 4)	51.5	53.6	55.9	-2.1/-4.4	-3.3	
2.36 (No. 8)	34.7	36.1	37.2	-1.4/-2.5	-2.0	
01.18 (No. 16)	23.3	25.0	23.9	-1.7/-0.6	-1.2	
0.600 (No. 30)	16.4	19.2	18.1	-2.8/-1.7	-2.3	
0.300 (No. 50)	12.0	11.1	12.7	+0.9/-0.7	+0.1	
0.150 (No. 100)	8.1	9.9	6.3	-1.8/+1.8	0.0	
75 µm (No. 200)	5.5	5.9	6.2	-0.4/-0.7	-0.6	<b>- 0.6</b>

In this example, all gradation test results performed on the residual aggregate (FOP for AASHTO T 30) would have an aggregate correction factor applied to the percent passing the 75 µm (No. 200) sieve. The correction factor must be applied because the average difference on the 75 µm (No. 200) sieve is outside the tolerance from Table 2.

In the following example, aggregate correction factors would be applied to each sieve because the average difference on the 4.75 mm (No. 4) is outside the tolerance from Table 2.

Sieve Size mm (in.)	Correction Factor Blank Sample % Passing	Correction Factor Sample #1 % Passing	Correction Factor Sample #2 % Passing	Difference 1 / 2	Avg. Diff.	Sieves to adjust
19.0 (3/4)	100	100	100	0/0	0.0	0.0
12.5 (1/2)	86.3	87.4	86.4	-1.1/-0.1	-0.6	<b>-0.6</b>
9.5 (3/8)	77.4	76.5	78.8	+0.9/-1.4	-0.3	<b>-0.3</b>
4.75 (No. 4)	51.5	55.6	57.9	-4.1/-6.4	-5.3	<b>-5.3</b>
2.36 (No. 8)	34.7	36.1	37.2	-1.4/-2.5	-2.0	<b>-2.0</b>
01.18 (No. 16)	23.3	25.0	23.9	-1.7/-0.6	-1.2	<b>-1.2</b>
0.600 (No. 30)	16.4	19.2	18.1	-2.8/-1.7	-2.3	<b>-2.3</b>
0.300 (No. 50)	12.0	11.1	12.7	+0.9/-0.7	+0.1	<b>+0.1</b>
0.150 (No. 100)	8.1	9.9	6.3	-1.8/+1.8	0.0	0.0
75 µm (No. 200)	5.5	5.9	6.2	-0.4/-0.7	-0.6	<b>-0.6</b>

**PERFORMANCE EXAM CHECKLIST**

**DETERMINING THE ASPHALT BINDER CONTENT OF ASPHALT MIXTURES BY THE IGNITION METHOD  
FOP FOR AASHTO T 308**

Participant Name \_\_\_\_\_ Exam Date \_\_\_\_\_

Record the symbols “P” for passing or “F” for failing on each step of the checklist.

Procedure Element	Trial 1	Trial 2
1. Oven at correct temperature $538 \pm 5^{\circ}\text{C}$ ( $1000 \pm 9^{\circ}\text{F}$ ) or correction factor temperature? Or: for IR ovens, correct burn profile applied?	_____	_____
2. Sample reduced to correct size?	_____	_____
3. Asphalt mixture sample or companion moisture sample taken and dried per FOP for AASHTO T 329?	_____	_____
4. Mass of sample basket assembly recorded to 0.1 g?	_____	_____
5. With pan below basket assembly, sample evenly distributed in basket assembly keeping material away from the edges?	_____	_____
6. Mass of sample basket and sample recorded to 0.1 g?	_____	_____
7. Sample mass conforms to the required mass?	_____	_____
8. Method A		
a. Initial mass entered into furnace controller?	_____	_____
b. Internal scale reading zero?	_____	_____
c. Sample correctly placed into furnace?	_____	_____
d. Test continued until stable indicator signals?	_____	_____
e. Uncorrected asphalt binder content obtained on printed ticket?	_____	_____
f. Sample cooled to room temperature?	_____	_____
g. Sample mass determined to nearest 0.1 g.?	_____	_____

OVER

**Procedure Element**

**Trial 1 Trial 2**

9. Method B

- a. Sample correctly placed into furnace? \_\_\_\_\_
- b. Sample burned for 45 min or time determined by correction process? \_\_\_\_\_
- c. Sample cooled to room temperature? \_\_\_\_\_
- d. Sample burned to constant mass? \_\_\_\_\_
- e. Sample cooled to room temperature? \_\_\_\_\_
- f. Sample mass determined to nearest 0.1 g? \_\_\_\_\_
- g. Uncorrected asphalt binder content calculated correctly and recorded? \_\_\_\_\_

10. Asphalt binder content corrected for Correction Factor if needed? \_\_\_\_\_

11. Asphalt binder content corrected for moisture per the FOP for AASHTO T 329 if needed? \_\_\_\_\_

12. Corrected asphalt binder content recorded? \_\_\_\_\_

13. Contents of the basket(s) carefully emptied into a pan? \_\_\_\_\_

Comments: First attempt: Pass\_\_\_\_Fail\_\_\_\_\_ Second attempt: Pass\_\_\_\_Fail\_\_\_\_\_

\_\_\_\_\_  
\_\_\_\_\_  
\_\_\_\_\_

**Examiner Signature** \_\_\_\_\_ **WAQTC #:** \_\_\_\_\_

## TEMPERATURE OF FRESHLY MIXED PORTLAND CEMENT CONCRETE FOP FOR AASHTO T 309

### Scope

This procedure covers the determination of the temperature of freshly mixed Portland Cement Concrete in accordance with AASHTO T 309-22.

**Warning**—Fresh Hydraulic cementitious mixtures are caustic and may cause chemical burns to skin and tissue upon prolonged exposure.

### Apparatus

- **Container:** Made of non-absorptive material and large enough to cover the sensor with concrete at least 75 mm (3 in.) in all directions; concrete cover must also be at least three times the nominal maximum size of the coarse aggregate.
- **Thermometer:** Capable of measuring the temperature of the concrete throughout the temperature range likely to be encountered, at least  $-18$  to  $50^{\circ}\text{C}$  ( $0$  to  $120^{\circ}\text{F}$ ), and readable to  $\pm 0.5^{\circ}\text{C}$  ( $\pm 1^{\circ}\text{F}$ ) or smaller.

*Note 1:* Thermometer types suitable for use include ASTM E1 mercury thermometer or ASTM E2251 Low Hazard Precision Liquid-in-glass thermometer; ASTM E2877 digital metal stem thermometer; or thermocouple thermometer ASTM E230, Type T Special or IEC 60584 Type T, Class 1.

### Standardization of Thermometer

Each thermometer shall be verified for accuracy annually and whenever there is a question of accuracy. Standardization shall be performed by comparing readings on the thermometer with another calibrated thermometer at two temperatures at least  $15^{\circ}\text{C}$  or  $27^{\circ}\text{F}$  apart.

### Sample Locations and Times

The temperature of freshly mixed concrete may be measured in the transporting equipment, in forms, or in sample containers, provided the sensor of the thermometer has at least 75 mm (3 in.) of concrete cover in all direction around it.

Complete the temperature measurement of the freshly mixed concrete within 5 minutes of obtaining the sample.

**Procedure**

1. Dampen the sample container.
2. Obtain the sample in accordance with the FOP for WAQTC TM 2.
3. Place sensor of the thermometer in the freshly mixed concrete so that it has at least 75 mm (3 in.) of concrete cover in all directions around it.
4. Gently press the concrete in around the sensor of the thermometer at the surface of the concrete so that air cannot reach the sensor.
5. Leave the sensor of the thermometer in the freshly mixed concrete for a minimum of two minutes, or until the temperature reading stabilizes.
6. Complete the temperature measurement of the freshly mixed concrete within 5 minutes of obtaining the sample.
7. Read and record the temperature to the nearest 0.5°C (1°F).

**Report**

- Results on forms approved by the agency
- Sample ID
- Measured temperature of the freshly mixed concrete to the nearest 0.5°C (1°F)

**PERFORMANCE EXAM CHECKLIST**

**TEMPERATURE OF FRESHLY MIXED CONCRETE  
FOP FOR AASHTO T 309**

Participant Name \_\_\_\_\_ Exam Date \_\_\_\_\_

Record the symbols "P" for passing or "F" for failing on each step of the checklist.

Procedure Element	Trial 1	Trial 2
1. Obtain sample of concrete large enough to provide a minimum of 75 mm (3 in.) of concrete cover around sensor in all directions?	_____	_____
2. Place thermometer in sample with a minimum of 75 mm (3 in.) cover around sensor?	_____	_____
3. Gently press concrete around thermometer?	_____	_____
4. Read temperature after a minimum of 2 minutes or when temperature reading stabilizes?	_____	_____
5. Complete temperature measurement within 5 minutes of obtaining sample?	_____	_____
6. Record temperature to nearest 0.5°C (1°F)?	_____	_____

Comments: First attempt: Pass\_\_\_\_Fail\_\_\_\_\_ Second attempt: Pass\_\_\_\_Fail\_\_\_\_\_

\_\_\_\_\_

\_\_\_\_\_

\_\_\_\_\_

\_\_\_\_\_

\_\_\_\_\_

\_\_\_\_\_

\_\_\_\_\_

\_\_\_\_\_

Examiner Signature \_\_\_\_\_ WAQTC #: \_\_\_\_\_

This checklist is derived, in part, from copyrighted material printed in ACI CP-1, published by the American Concrete Institute.

CONCRETE

WAQTC

FOP AASHTO T 309 (09)



## WSDOT Errata to FOP for AASHTO T 310

### *In-Place Density and Moisture Content of Soil and Soil-Aggregate by Nuclear Methods (Shallow Depth)*

WAQTC FOP for AASHTO T 310 has been adopted by WSDOT with the following changes:

#### Procedure

*Replace step 1 with below:*

1. WSDOT requires test location selected per WSDOT SOP 615.
6. Place the gauge on the prepared surface so the source rod can enter the hole without disturbing loose material.

*Include note below:*

**Note:** For alignment purposes, the user may expose the source rod for a maximum of ten seconds.

10. Perform one of the following methods, per agency requirements:
  - a. Method A Single Direction: - *Method not recognized by WSDOT.*
11. *Step not required by WSDOT.*
12. *Step not required by WSDOT.*

*Replace step 13 with below:*

13. Determine the dry density by one of the following:
  - a. If the moisture content is determined by nuclear methods, use gauge dry density readings directly.
  - b. If moisture content is determined by FOP for AASHTO T 255/T 265, compute dry density by dividing the wet density from the nuclear gauge by  $1 + \text{moisture content}$  expressed as a decimal.

#### Percent Compaction

*Determined using WSDOT SOP 615.*



**IN-PLACE DENSITY AND MOISTURE CONTENT OF SOIL AND SOIL-  
AGGREGATE BY NUCLEAR METHODS (SHALLOW DEPTH)  
FOP FOR AASHTO T 310****Scope**

This procedure covers the determination of density, moisture content, and relative compaction of soil, aggregate, and soil-aggregate mixes in accordance with AASHTO T 310-22. This procedure provides a rapid, nondestructive technique for determining the in-place wet density and moisture content of soil, aggregate, and soil-aggregate mixes. This field operating procedure is derived from AASHTO T 310. The nuclear moisture-density gauge is used in the direct transmission mode.

**Apparatus**

- Nuclear density gauge with the factory matched standard reference block.
- Drive pin, guide/scrapper plate, and hammer for testing in direct transmission mode.
- Transport case for properly shipping and housing the gauge and tools.
- Instruction manual for the specific make and model of gauge.
- Radioactive materials information and calibration packet containing:
  - Daily Standard Count Log.
  - Factory and Laboratory Calibration Data Sheet.
  - Leak Test Certificate.
  - Shippers Declaration for Dangerous Goods.
  - Procedure Memo for Storing, Transporting and Handling Nuclear Testing Equipment.
  - Other radioactive materials documentation as required by local regulatory requirements.
- Sealable containers and utensils for moisture content determinations.

**Radiation Safety**

This method does not purport to address all of the safety problems associated with its use. This test method involves potentially hazardous materials. The gauge utilizes radioactive materials that may be hazardous to the health of the user unless proper precautions are taken. Users of this gauge must become familiar with the applicable safety procedures and governmental regulations. All operators will be trained in radiation safety prior to operating nuclear density gauges. Some agencies require the use of personal monitoring devices such as a thermoluminescent dosimeter or film badge. Effective instructions together with routine safety procedures such as source leak tests, recording and evaluation of personal monitoring device data, etc., are a recommended part of the operation and storage of this gauge.

## Calibration

Calibrate the nuclear gauge as required by the agency. This calibration may be performed by the agency using manufacturer's recommended procedures or by other facilities approved by the agency. Verify or re-establish calibration curves, tables, or equivalent coefficients every 12 months.

## Standardization

1. Turn the gauge on and allow it to stabilize (approximately 10 to 20 minutes) prior to standardization. Leave the power on during the day's testing.
2. Standardize the nuclear gauge at the construction site at the start of each day's work and as often as deemed necessary by the operator or agency. Daily variations in standard count shall not exceed the daily variations established by the manufacturer of the gauge. If the daily variations are exceeded after repeating the standardization procedure, the gauge should be repaired and/or recalibrated.
3. Record the standard count for both density and moisture in the Daily Standard Count Log. The exact procedure for standard count is listed in the manufacturer's Operator's Manual.

*Note 1:* New standard counts may be necessary more than once a day. See agency requirements.

## Overview

There are two methods for determining in-place density of soil / soil aggregate mixtures. See agency requirements for method selection.

- Method A Single Direction
- Method B Two Direction

## Procedure

1. Select a test location(s) randomly and in accordance with agency requirements. Test sites should be relatively smooth and flat and meet the following conditions:
  - a. At least 10 m (30 ft) away from other sources of radioactivity
  - b. At least 3 m (10 ft) away from large objects
  - c. The test site should be at least 150 mm (6 in.) away from any vertical projection.
  - d. Correct for trench wall effect according to manufacturer's correction procedures if the test site is closer than 600 mm (24 in.) to vertical projection. See Note 2.

*Note 2:* To perform moisture and density tests in a trench or against a large solid object, it is necessary to perform a trench offset correction to adjust the gauge, or it may read a falsely high moisture content. Moisture present in the walls can thermalize neutrons which return to the gauge and are read as moisture by the detector in the gauge.

2. Remove all loose and disturbed material and remove additional material as necessary to expose the top of the material to be tested.
3. Prepare a flat area sufficient in size to accommodate the gauge. Plane the area to a smooth condition so as to obtain maximum contact between the gauge and the

material being tested. For Method B, the flat area must be sufficient to permit rotating the gauge 90 or 180 degrees about the source rod.

4. Fill in surface voids beneath the gauge with fines of the material being tested passing the 4.75 mm (No. 4) sieve or finer. Smooth the surface with the guide plate or other suitable tool. The depth of the filler should not exceed approximately 3 mm (1/8 in.).
5. Make a hole perpendicular to the prepared surface using the guide plate and drive pin. The hole shall be at least 50 mm (2 in.) deeper than the desired source rod depth and shall be aligned such that insertion of the source rod will not cause the gauge to tilt from the plane of the prepared area. Remove the drive pin by pulling straight up and twisting the extraction tool.
6. Place the gauge on the prepared surface so the source rod can enter the hole without disturbing loose material.
7. Lower the source rod into the hole to the desired test depth using the handle and trigger mechanism.
8. Seat the gauge firmly by partially rotating it back and forth about the source rod. Ensure the gauge is seated flush against the surface by pressing down on the gauge corners and making sure that the gauge does not rock.
9. Pull gently on the gauge to bring the side of the source rod nearest to the scaler / detector firmly against the side of the hole.
10. Perform one of the following methods, per agency requirements:
  - a. Method A Single Direction: Take a test consisting of the average of two, one-minute readings, and record both density and moisture data. The two wet density readings should be within  $32 \text{ kg/m}^3$  ( $2.0 \text{ lb/ft}^3$ ) of each other. The average of the two wet densities and moisture contents will be used to compute dry density.
  - b. Method B Two Direction: Take a one-minute reading and record both density and moisture data. Rotate the gauge 90 or 180 degrees, pivoting it around the source rod. Reseat the gauge by pulling gently on the gauge to bring the side of the source rod nearest to the scaler/detector firmly against the side of the hole and take a one-minute reading. (In trench locations, rotate the gauge 180 degrees for the second test.) Some agencies require multiple one-minute readings in both directions. Analyze the density and moisture data. A valid test consists of wet density readings in both gauge positions that are within  $50 \text{ kg/m}^3$  ( $3.0 \text{ lb/ft}^3$ ). If the tests do not agree within this limit, move to a new location. The average of the wet density and moisture contents will be used to compute dry density.
11. If required by the agency, obtain a representative sample of the material, 4 kg (9 lb) minimum, from directly beneath the gauge full depth of material tested. This sample will be used to verify moisture content and / or identify the correct density standard. Immediately seal the material to prevent loss of moisture.

The material tested by direct transmission can be approximated by a cylinder of soil approximately 300 mm (12 in.) in diameter directly beneath the centerline of the

radioactive source and detector. The height of the cylinder will be approximately the depth of measurement. When organic material or large aggregate is removed during this operation, disregard the test information, and move to a new test site.

12. To verify the moisture content from the nuclear gauge, determine the moisture content with a representative portion of the material using the FOP for AASHTO T 255/T 265 or other agency approved methods. If the moisture content from the nuclear gauge is within  $\pm 1$  percent, the nuclear gauge readings can be accepted. Moisture content verification is gauge and material specific. Retain the remainder of the sample at its original moisture content for a one-point compaction test under the FOP for AASHTO T 272, or for gradation, if required.

*Note 2:* Example: A gauge reading of 16.8 percent moisture and an oven dry of 17.7 percent are within the  $\pm 1$  percent requirement. Moisture correlation curves will be developed according to agency guidelines. These curves should be reviewed and possibly redeveloped every 90 days.

13. Determine the dry density by one of the following.
  - a. From nuclear gauge readings, compute by subtracting the mass (weight) of the water ( $\text{kg/m}^3$  or  $\text{lb/ft}^3$ ) from the wet density ( $\text{kg/m}^3$  or  $\text{lb/ft}^3$ ) or compute using the percent moisture by dividing wet density from the nuclear gauge by 1 plus the moisture content expressed as a decimal.
  - b. When verification is required and the nuclear gauge readings cannot be accepted, the moisture content is determined by the FOP for AASHTO T 255/T 265 or other agency approved methods. Compute dry density by dividing wet density from the nuclear gauge by 1 plus the moisture content expressed as a decimal.

### Percent Compaction

- Percent compaction is determined by comparing the in-place dry density as determined by this procedure to the appropriate agency density standard. For soil or soil-aggregate mixes, these are moisture-density curves developed using the FOP for AASHTO T 99/T 180. When using maximum dry densities from the FOP for AASHTO T 99/T 180 or FOP for AASHTO T 272, it may be necessary to use the Annex in the FOP for T 99/T 180 to determine corrected maximum dry density and optimum moisture content.

For coarse granular materials, the density standard may be density-gradation curves developed using a vibratory method such as AKDOT&PF's ATM 212, ITD's T 74, WAQTC TM 15, or WFLHD's Humphres.

See appropriate agency policies for use of density standards.

EMBANKMENT AND BASE  
IN-PLACE DENSITY

WAQTC

FOP AASHTO T 310 (22)

## Calculation

Calculate the dry density as follows:

$$\rho_d = \left( \frac{\rho_w}{w + 100} \right) \times 100 \quad \text{or} \quad \rho_d = \frac{\rho_w}{\frac{w}{100} + 1}$$

Where:

$\rho_d$  = Dry density, kg/m<sup>3</sup> (lb/ft<sup>3</sup>)

$\rho_w$  = Wet density, kg/m<sup>3</sup> (lb/ft<sup>3</sup>)

w = Moisture content from the FOP's for AASHTO T 255 / T 265, as a percentage

Calculate percent compaction as follows:

$$\% \text{ Compaction} = \frac{\rho_d}{\text{Agency density standard}} \times 100$$

Where:

$\rho_d$  = Dry density, kg/m<sup>3</sup> (lb/ft<sup>3</sup>)

Agency density standard = Corrected maximum dry density  
from the FOP from T 99/T 180 Annex

## Example:

Wet density readings from gauge: 1948 kg/m<sup>3</sup> (121.6 lb/ft<sup>3</sup>)

1977 kg/m<sup>3</sup> (123.4 lb/ft<sup>3</sup>)

Avg: 1963 kg/m<sup>3</sup> (122.5 lb/ft<sup>3</sup>)

**Moisture readings from gauge: 14.2% and 15.4% = Avg 14.8%**

Moisture content from the FOP's for AASHTO T 255/ T 265: 15.9%

*Moisture content is greater than 1 percent different so the gauge moisture cannot be used.*

EMBANKMENT AND BASE  
IN-PLACE DENSITY

WAQTC

FOP AASHTO T 310 (22)

**Calculate the dry density as follows:**

$$\rho_d = \left( \frac{1963 \text{ kg/m}^3 \text{ or } 122.5 \text{ lb/ft}^3}{15.9 + 100} \right) \times 100 \text{ or } \rho_d = \frac{1963 \text{ kg/m}^3 \text{ or } 122.5 \text{ lb/ft}^3}{\frac{15.9}{100} + 1}$$

$$= 1694 \text{ kg/m}^3 \text{ or } 105.7 \text{ lb/ft}^3$$

Given:

$$\rho_w = 1963 \text{ kg/m}^3 \text{ or } 122.5 \text{ lb/ft}^3$$

$$w = 15.9\%$$

**Calculate percent compaction as follows:**

$$\% \text{ Compaction} = \frac{105.7 \text{ lb/ft}^3}{111.3 \text{ lb/ft}^3} \times 100 = 95\%$$

Given:

$$\text{Agency density standard} = 111.3 \text{ lb/ft}^3$$

## Report

- On forms approved by the agency
- Sample ID
- Location of test, elevation of surface, and thickness of layer tested
- Visual description of material tested
- Make, model and serial number of the nuclear moisture-density gauge
- Wet density to the nearest 0.1 lb/ft<sup>3</sup>
- Moisture content as a percent, by mass, of dry soil mass to the nearest 0.1 percent
- Dry density to the nearest 0.1 lb/ft<sup>3</sup>
- Density standard to the nearest 0.1 lb/ft<sup>3</sup>
- Percent compaction the nearest 1 percent
- Name and signature of operator



IN-PLACE DENSITY

WAQTC

FOP AASHTO T 310 (20)

**PERFORMANCE EXAM CHECKLIST****IN-PLACE DENSITY AND MOISTURE CONTENT OF SOIL AND SOIL-AGGREGATE BY NUCLEAR METHODS (SHALLOW DEPTH)  
FOP FOR AASHTO T 310**

Participant Name \_\_\_\_\_ Exam Date \_\_\_\_\_

**Record the symbols “P” for passing or “F” for failing on each step of the checklist.**

<b>Procedure Element</b>	<b>Trial 1</b>	<b>Trial 2</b>
1. Gauge turned on 10 to 20 minutes before use?	_____	_____
2. Calibration verified?	_____	_____
3. Standard count taken and recorded in accordance with manufacturer’s instructions?	_____	_____
4. Test location selected appropriately 10 m (30 ft.) from other radioactive sources, 3 m (10 ft.) from large objects, 150 mm (6 in.) away from vertical projections?	_____	_____
5. Loose, disturbed material removed?	_____	_____
6. Flat, smooth area prepared?	_____	_____
7. Surface voids filled with native fines (-No. 4) to 3 mm (1/8 in.) maximum thickness?	_____	_____
8. Hole driven 50 mm (2 in.) deeper than source rod depth?	_____	_____
9. Gauge placed and source rod lowered without disturbing loose material?	_____	_____
10. Method A:		
a. Gauge firmly seated, and gently pulled back so that the source rod is against the side of the hole toward the scaler / detectors?	_____	_____
b. Two, one-minute reading taken; wet density within 32 kg/m <sup>3</sup> (2.0 lb/ft <sup>3</sup> )?	_____	_____
c. Density and moisture data averaged?	_____	_____
11. Method B:		
a. Gauge firmly seated, and gently pulled back so that the source rod is against the side of the hole toward the scaler / detectors?	_____	_____
b. A minimum of a one-minute reading taken; density and moisture data recorded?	_____	_____
c. Gauge turned 90° or 180° (180° in trench)?	_____	_____

**OVER**

Procedure Element	Trial 1	Trial 2
d. Gauge firmly seated, and gently pulled back so that the source rod is against the side of the hole toward the scaler / detectors?	_____	_____
e. A minimum of a one-minute reading taken; density and moisture data recorded?	_____	_____
f. Wet densities within 50 kg/m <sup>3</sup> (3.0 lb/ft <sup>3</sup> )?	_____	_____
g. Density and moisture data averaged?	_____	_____
12. Representative sample (4 kg or 9 lb) obtained from test location?	_____	_____
13. Sample sealed immediately to prevent moisture loss?	_____	_____
14. Moisture content correctly determined using other means than the nuclear density gauge reading?	_____	_____
15. Dry Density calculated using proper moisture content?	_____	_____
16. Percent compaction calculated correctly?	_____	_____

Comments: First attempt: Pass \_\_\_\_\_ Fail \_\_\_\_\_ Second attempt: Pass \_\_\_\_\_ Fail \_\_\_\_\_

\_\_\_\_\_

\_\_\_\_\_

\_\_\_\_\_

\_\_\_\_\_

\_\_\_\_\_

\_\_\_\_\_

\_\_\_\_\_

\_\_\_\_\_

\_\_\_\_\_

\_\_\_\_\_

Examiner Signature \_\_\_\_\_ WAQTC #: \_\_\_\_\_

## WSDOT Errata to FOP for AASHTO T 312

### *Preparing and Determining the Density of Asphalt Mixture Specimens by Means of the Superpave Gyrotory Compactor*

WAQTC FOP for AASHTO T 312 has been adopted by WSDOT with the following changes:

#### Equipment Preparation

*Include bullet below:*

- Pre-heat molds and plates in the oven set no more than 25° F above the compaction temperature shown on the mix design report.

#### Sample Preparation

##### Plant Produced Asphalt Mixtures

*Replace step 3 with below:*

3. Place in the oven until the material is 5° F above the compaction temperature shown on the mix design report.

#### Compaction Procedure

*Replace step 3 with below:*

3. Place the mixture into the mold in one lift by performing the following within approximately 60 seconds. Care should be taken to avoid segregation in the mold.
  - a) Remove the pan of Asphalt Mixture from the oven and in one motion invert the pan onto the construction paper, vinyl mat, etc. Quickly remove any material that remains in the pan and include it with the Asphalt Mixture sample to be compacted.
  - b) Grasp opposing edges of the paper and roll them together to form the Asphalt Mixture into a cylindrical shape.
  - c) Insert one end of the paper roll into the bottom of the compaction mold and remove the paper as the Asphalt Mixture slides into the mold.

#### Report

*Include bullet below:*

- Provide record of height of the specimen after each gyration to the nearest 0.1 mm during compaction.



## PREPARING AND DETERMINING THE DENSITY OF ASPHALT MIXTURE SPECIMENS BY MEANS OF THE SUPERPAVE GYRATORY COMPACTOR FOP FOR AASHTO T 312

### Scope

This procedure covers preparing specimens, using samples of plant produced asphalt mixtures, for determining the mechanical and volumetric properties of asphalt mixtures in accordance with AASHTO T 312-22.

### Apparatus

- Superpave Gyratory Compactor (SGC) meeting the requirements of AASHTO T 312
- Molds meeting the requirements of AASHTO T 312
- Chute, mold funnel or both (Optional)
- Scale meeting the requirements of AASHTO M 231 Class G 5
- Oven, thermostatically controlled, capable of maintaining set temperature within  $\pm 3^{\circ}\text{C}$  ( $\pm 5^{\circ}\text{F}$ )
- Thermometers with a temperature range of at least 10 to  $230^{\circ}\text{C}$  (50 -  $450^{\circ}\text{F}$ ) and accurate to  $\pm 1^{\circ}\text{C}$  ( $\pm 2^{\circ}\text{F}$ )

*Note 1:* Non-Contact thermometers are not acceptable.

- Miscellaneous pans, spoons, spatulas, hot pads, gloves, paper discs, markers, etc.

### Equipment Requirements

The calibration shall be performed on the SGC per the Manufacturer's instructions. See agency requirements for the calibration frequency.

The mold and base plate dimensions shall be checked every twelve months or 80 hours of operation to determine that they are within the tolerances listed in AASHTO T 312.

### Equipment Preparation

Prepare the equipment in accordance with manufacturer's recommendations. At a minimum preparation includes:

- Warm-up gyratory compactor
- Verify machine settings
  - Internal Angle:  $1.16 \pm 0.02^{\circ}$
  - Ram Pressure:  $600 \pm 18$  kPa

- Number of gyrations

*Note 2:* The number of gyrations ( $N_{des}$ ) is obtained from the Job Mix Formula (JMF).

- Lubricate bearing surfaces
- Prepare recording device as required
- Pre-heat molds and plates at the compaction temperature range (minimum of 30 min.) or before reuse reheat (minimum of 5 min.)

*Note 3:* The use of multiple molds will speed up the compaction process.

- Pre-heat chute, mold funnel, spatulas, and other apparatus (not to exceed the maximum compaction temperature)

## Sample Preparation

### Laboratory Prepared Asphalt Mixtures

This is a sample produced during the Mix Design process using aggregate and binder that is combined in the laboratory. When designing asphalt mixtures using the gyratory compactor, refer to AASHTO T 312 and AASHTO R 35.

### Plant Produced Asphalt Mixtures

- Determine initial sample size, number of gyrations ( $N_{des}$ ), and compaction temperature range from the Job Mix Formula (JMF).
- Obtain the sample in accordance with the FOP for AASHTO R 97.
- Reduce the sample in accordance with the FOP for AASHTO R 47.
- The sample size should be such that it results in a compacted specimen that is  $115 \pm 5$  mm at the desired number of gyrations.

*Note 4:* Replicate specimens are generally prepared. Refer to agency requirements.

If the material is not in the compaction temperature range:

1. Place the appropriate sample mass into a container.
2. Spread to a depth of 1 to 2 in. for even heating of mixture.
3. Place in the oven until the material is within the compaction temperature range.

*Note 5:* The material properties may be altered when the times of delivery of the test sample and the placement of the material on the roadway are different.

## Compaction Procedure

Follow the manufacturer's recommended loading procedure. This may require the steps below to be performed in a different order. Steps 1 through 8 must be performed before the sample and mold cools below minimum compaction temperature.

1. Remove pre-heated mold and plate(s) from the oven (verify mold and plate(s) has been cleaned if previously used).
2. Place the base plate and paper disc in bottom of mold.
3. Place the mix into the mold in a single lift (care should be taken to avoid segregation or loss of material).
4. Level the mix in the mold.
5. Place a paper disc and the heated upper plate (if required) on top of the leveled sample.
6. Load the mold into the compactor, check settings.
7. Start the compaction process.
8. Extrude the specimen from the mold; a brief cooling period may be necessary before fully extruding some specimens to ensure the specimens are not damaged.

*Note 6:* Clean molds after each use.

9. Upon completion of the compaction process, record the number of gyrations and specimen height.

*Note 7:* If the specimen is not  $115 \pm 5$  mm, follow agency requirements.

10. Carefully remove the paper discs.
11. Cool the compacted specimen to room temperature.
12. Identify the specimen with chalk or other marker.

## Report

- On forms approved by the agency
- Sample ID
- Number of gyrations
- Specimen height to the nearest 0.1 mm





**PERFORMANCE EXAM CHECKLIST****PREPARING AND DETERMINING THE DENSITY OF ASPHALT MIXTURE SPECIMENS BY MEANS OF THE SUPERPAVE GYRATORY COMPACTOR FOP FOR AASHTO T 312**

Participant Name \_\_\_\_\_ Exam Date \_\_\_\_\_

Record the symbols "P" for passing or "F" for failing on each step of the checklist.

<b>Procedure Element</b>	<b>Trial 1</b>	<b>Trial 2</b>
1. Gyratory warmed up?	_____	_____
2. Verify gyratory settings?	_____	_____
a. Angle		
b. Pressure 600 ±18 kPa		
c. Number of gyrations set?	_____	_____
3. Bearing surfaces lubricated?	_____	_____
4. Mold, base plate, and upper plate heated to compaction temperature range?	_____	_____
5. Representative sample obtained according to the FOP for AASHTO R 97?	_____	_____
6. Sample reduced according to FOP AASHTO R 47?	_____	_____
7. Sample placed in a container and spread to 1 or 2 inches thick for even heating?	_____	_____
8. Asphalt mixture heated to within compaction temperature range?	_____	_____
9. Mold, base plate, and upper plate (if required) removed from oven and paper disk placed on bottom of mold?	_____	_____
10. Mix placed into mold in one lift without segregation or loss?	_____	_____
11. Mix leveled?	_____	_____
12. Paper disk placed on top of the asphalt mixture?	_____	_____
13. Mold placed into compactor and upper plate clamped into place?	_____	_____
14. Specified number of gyrations applied?	_____	_____
15. Proper angle confirmed from display?	_____	_____
16. Compacted specimen extruded from mold?	_____	_____
17. Specimen height and number of gyrations recorded?	_____	_____
18. Paper disc(s) removed, and specimen allowed to cool to room temperature?	_____	_____

**Over**

ASPHALT II

WAQTC

FOP AASHTO T 312 (24)

Comments:      First attempt:    Pass \_\_\_\_ Fail \_\_\_\_      Second attempt:    Pass \_\_\_\_ Fail \_\_\_\_

---

---

---

---

Examiner Signature \_\_\_\_\_ WAQTC #: \_\_\_\_\_



**WSDOT Test Method T 313**

***Method of Test for Cement-Latex Compatibility***

**1. Scope**

This method tests the compatibility of cement and latex additives when combined.

**2. Equipment**

- a. Two brass cylindrical unit weight cups having an inside diameter of 3 in (76 mm) and a depth of approximately 3<sup>1</sup>/<sub>32</sub> in (88 mm).
- b. Mixer, bowl, and paddle conforming to AASHTO 162.
- c. Straightedge – A steel straight edge, not less than 4 in (102 mm) long, and not less than 1/16 in (1.6 mm) nor more than 1/8 in (3.2 mm) in thickness.
- d. Glass Graduated Cylinder – Shall have 250 ml capacity, graduations at 2 ml intervals, made to deliver indicated volume at 20°C.
- e. Glass Beaker – Shall have at least a 300 ml capacity.
- f. Balance – Must conform to ASTM C 1005.
- g. Tapping Stick – Made of hardwood, a diameter of 1/8 in (3.2 mm), and a length of 6 in (152 mm).
- h. Tamper – Made of hardwood, a diameter of 7/16 in (11 mm), and a length of 6 in (152 mm).
- i. Scoop – Approximately 8 in (203 mm) long, and 3 in (76 mm) wide.
- j. Scraper – Shall consist of a semirigid rubber blade attached to a handle about 6 in (152 mm) long. Blade is about 3 1/2 in (90 mm) long and 2 in (50 mm) wide. (Kitchen tool called a plate and bowl scraper meets these requirements.)

**3. Procedure**

- a. Weigh out a batch of washed and dried Steilacoom aggregate (B-1), using the following table:

U.S. No. Screen Size		Batch Weights (grams)	
		Individual Wt.	Accumulative Wt.
3/8 in - #4	(9.5 mm - 4.75 mm)	14	14
#4 - #8	(4.75 mm - 2.36 mm)	205	219
#8 - #16	(2.36 mm - 1.18 mm)	186	405
#16 - #30	(1.18 mm - 600 µm)	230	635
#30 - #50	(600 µm - 300 µm)	561	1196
#50 - minus	(600 µm - minus)	278	1474

- b. Weigh out 1 lb (454 g) of the cement candidate. Measure 4.80 oz (142 ml) of the latex candidate into a beaker. 2.976 oz. (Measure 88 ml) of water into the graduated cylinder.
- c. Put the aggregate and cement into the mixer bowl. (Adjust the blade to bowl clearance for the largest aggregate size first.) Mix the dry ingredients for 45 seconds at speed 1. Stop the mixer.
- d. Pour the latex sample into the mixer bowl. Rinse the latex beaker with the measured mixing water, then pour the solution into the mixing bowl.
- e. Mix for one minute at speed 1.
- f. Stop mixer for three minutes. Scrape down the sides and check the bottom of the bowl for sand pockets using the bowl scraper.
- g. Mix for ten seconds at speed 1.
- h. Tare the first unit weight (mass) cup.
- i. Use the scoop to fill the unit weight (mass) cup in three lifts. For each lift, tamp with the small wood dowel 25 times, just penetrating the layer below it, and strike the side of the unit weight (mass) cup sharply five times with the large wood dowel, at equal intervals around its circumference.
- j. Cut off the mortar to a plane surface, flush with the top of the unit weight (mass) cup, by drawing the straight edge, held at 90 degrees, with a sawing motion across the top, making two passes over the entire surface, the second pass being made at right angles to the first. Wipe off all mortar and water from the sides of the unit weight (mass) cup. Record the weight (mass). Tare the second unit weight (mass) cup and fill with the remaining mortar from the bowl, and repeat the procedure. Record the second weight (mass).

#### 4. Calculations

- a. Calculate the average weight (mass) of the two samples.

#### 5. Significance

If a latex additive and concrete mix are incompatible, they will react chemically, changing the specific gravity and density, which will adversely affect the final strength of the concrete/latex. In this test method, an adverse reaction is determined by examining the weight (mass) of the two wet products when combined. A very lightweight means there is probably a problem, and a different latex or cement should be submitted for testing.



## **WSDOT Test Method T 314**

### ***Method of Test for Photovolt Reflectance***

#### **1. Scope**

- a. This method covers the determination of the 45-degree, 0-degree directional reflectance factor of nonfluorescent opaque specimens by means of a filter photometer.

#### **2. Apparatus**

- a. Photovoltmeter/reflectometer conforming to ASTM E 1347.
- b. Calibrated standard plaques.
- c. Black plastic film canister.
- d. Filters.

#### **3. Procedure**

- a. Reflectometer Calibration
  1. Warm up the reflectometer for 30 minutes before use.
  2. Calibrate and zero the reflectometer, Photovolt Model 577 or equivalent per ASTM E 1347, according to the manufacturer's User Manual.
    - a. Select standard plaque for calibration that is slightly higher than the expected percent reflectance of the samples.
- b. Reflectance Determination
  1. For testing lane markers, move the unit to determine an average reading. Recheck the standard plaque reading and the zero reading between each sample measurement.
  2. Report
    - a. Report the average result of all readings for a sample to the nearest percent.





## **WSDOT SOP 318**

### ***Standard Operating Procedure for Melting of Flexible Bituminous Pavement Marker Adhesive for Evaluation***

#### **1. Scope**

- 1.1. This standard covers the handling, cutting, and melting of Flexible Bituminous Adhesive.
- 1.2. This standard may involve hazardous materials, operations, and equipment. This standard does not purport to address all of the safety concerns associated with its use. It is the responsibility of the user of this standard to establish appropriate safety and health practices and determine the applicability of regulatory limitations prior to use.

#### **2. Referenced Documents**

- 2.1. ASTM Standards:
  - D 5167 Standard Practice for Melting of Hot-Applied Joint and Crack Sealant and Filler for Evaluation.

#### **3. Significance and Use**

- 3.1. This standard establishes the procedure for handling, cutting and melting of Flexible Bituminous Pavement Marker Adhesives in preparation for the making of test specimens used in the laboratory evaluations of the Flexible Bituminous Pavement Marker Adhesives.

#### **4. Apparatus**

- 4.1. Laboratory Melter:
  - An appropriate laboratory melter as described in section 6.1 of ASTM D5167.
- 4.2. Cutting Device:
  - A heated knife or saw capable of cutting a vertical cross section from a solid adhesive sample.

#### **5. Hazards**

- 5.1. Use standard safety precautions and Personal Protective Equipment (PPE) when handling hot materials and preparing test specimens.
- 5.2. Prior to handling, cutting, or melting flexible bituminous pavement marker adhesive, a Material Safety Data Sheet (MSDS) must be obtained from the manufacturer so that proper safe handling techniques will be used.

## 6. Procedure

- 6.1 Cut a complete vertical section from the block of adhesive in order to obtain a uniform representative sample (see figure 1) and to supply enough product to pour all specimens for testing.
- 6.2 To avoid compatibility problems clean the melting container so that it is free of all cleaning solvents and previously melted material.
- 6.3 All segments from one vertical section must be melted in the same melting container. If necessary cut the sample to fit into container.
- 6.4 Heat and maintain the oil bath to  $405 \pm 5^\circ\text{F}$ . Place the sample container into the heating apparatus. Insert paddle for stirring as soon as sample begins to melt. Begin continuous stirring immediately after inserting the paddle. Check the sample temperature frequently. Keep the sample container covered except when checking the sample temperature.
- 6.5 Heat the sample to  $398 \pm 2^\circ\text{F}$ . Once the sample has become fluid and reached temperature, stop the mechanical stirring device and immediately remove sample container from the melter. Clean oil residue or wrap container with towel to ensure bath oil does not contaminate sample. Pour all required specimens immediately following removal of the sample container from the melter to minimize temperature loss.
- 6.6 Do not reuse sample once melted and split for testing. If retesting is necessary, a new specimen must be cut from the original sample.

Cut vertically through sample block to remove entire cross section for testing.

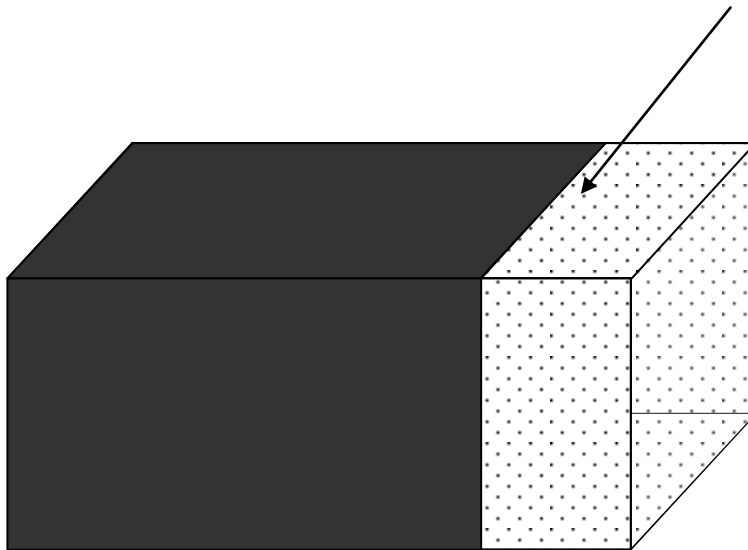

**Figure 1**



## **WSDOT Errata to AASHTO T 324**

### ***Hamburg Wheel-Track Testing of Compacted Asphalt Mixtures***

AASHTO T 324 has been adopted by WSDOT with the following changes:

#### **7. Determining Air Void Content**

7.3. Determine the air void content of the specimens in accordance with T 269. The recommended target air void content is  $7.0 \pm 1.0$  percent for laboratory-compacted SGC cylindrical specimens and  $7.0 \pm 1.0$  percent for laboratory-compacted slab specimens. Field specimens may be tested at the air void content at which they are obtained.

#### **8. Procedure**

8.6.1. Select a test temperature of 50° C.



## Tester Qualification Practical Exam Checklist

### AASHTO T 324

#### *Hamburg Wheel-Track Testing of Compacted Asphalt Mixtures*

Participant Name: \_\_\_\_\_ Exam Date: \_\_\_\_\_

Record the symbols "P" for passing or "F" for failing on each step of the checklist.

Procedure Element	Trial 1	Trial 2
1. The tester has a copy of the current procedure on hand?	_____	_____
2. All equipment is functioning according to the test procedure, and if required, has the current calibration/verification tags present?	_____	_____
3. Specimen height is $62 \pm 1.0$ mm ( $2.44 \pm 0.04$ in.) or 38.1 mm (1.5 inch) minimum for cores?	_____	_____
4. Specimen meets air void tolerance of $7.0 + 1.0$ %?	_____	_____
5. Specimens placed in molds and loaded into trays with a maximum gap of 7.5 mm between molds?	_____	_____
6. Tray mounted in machine and securely fastened?	_____	_____
7. Sample data and testing parameters entered into computer? (e.g., sample name, agg source, wheel speed, maximum rut depth, number of passes, and water temperature)	_____	_____
8. Wheels gently lowered and samples allowed to soak at testing temperature for 45 minutes?	_____	_____
9. Wheel tracking device shut off when test parameters are reached?	_____	_____
10. Test data obtained for charting and analysis?	_____	_____

Comments: First Attempt: Pass \_\_\_\_\_ Fail \_\_\_\_\_ Second Attempt: Pass \_\_\_\_\_ Fail \_\_\_\_\_

Examiner Signature: \_\_\_\_\_ WAQTC #: \_\_\_\_\_



## MOISTURE CONTENT OF ASPHALT MIXTURES BY OVEN METHOD FOP FOR AASHTO T 329

### Scope

This procedure covers the determination of moisture content of asphalt mixtures in accordance with AASHTO T 329-22.

### Overview

Moisture content is determined by comparing the wet mass of a sample and the mass of the sample after drying to constant mass. The term constant mass is used to define when a sample is dry.

*Constant mass* – the state at which a mass does not change more than a given percent, after additional drying for a defined time interval, at a required temperature.

### Apparatus

- Balance or scale: 2 kg capacity, readable to 0.1 g and conforming to AASHTO M 231.
- Forced draft, ventilated, or convection oven: Capable of maintaining the temperature surrounding the sample at  $163 \pm 14^{\circ}\text{C}$  ( $325 \pm 25^{\circ}\text{F}$ ).
- Container: Clean, dry, not affected by heat and of sufficient size to contain a test sample without danger of spilling.
- Thermometer or other suitable device with a temperature range of 50 to  $200^{\circ}\text{C}$  ( $122$  to  $392^{\circ}\text{F}$ ) and readable to the nearest  $2^{\circ}\text{C}$  ( $4^{\circ}\text{F}$ ).

### Sample

The test sample shall be obtained in accordance with the FOP for AASHTO R 97 and reduced in accordance with the FOP for AASHTO R 47. The size of the test sample shall be a minimum of 1000 g.

### Procedure

1. Preheat the oven to the Job Mix Formula (JMF) mixing temperature range. If the mixing temperature is not supplied, a temperature of  $163 \pm 14^{\circ}\text{C}$  ( $325 \pm 25^{\circ}\text{F}$ ) is to be used.
2. Determine and record the mass of the container, including release media, to the nearest 0.1 g.  
*Note 1:* When using paper or other absorptive material to line the container ensure it is dry before determining initial mass of container.
3. Place the wet sample in the container.
4. Determine and record the temperature of the sample.
5. Determine and record the mass of the sample and container to the nearest 0.1 g.
6. Determine and record the wet mass ( $M_i$ ) of the sample by subtracting the container mass determined in Step 2 from the mass of the sample and container determined in Step 5.

7. Place the sample and container in the oven and dry for  $90 \pm 5$  min.
8. Determine the mass of sample and container.
9. Determine and record the mass of the sample by subtracting the container mass determined in Step 2 from the mass of the sample and container determined in Step 8.
10. Return sample and container to the oven and dry for  $30 \pm 5$  min.
11. Determine the mass of sample and container.
12. Determine and record the mass of the sample by subtracting the container mass determined in Step 2 from the mass of the sample and container determined in Step 11.
13. Determine percent change by subtracting the new mass determination ( $M_n$ ) from the previous mass determination ( $M_p$ ), dividing by the previous mass determination ( $M_p$ ), and multiplying by 100.
14. Continue drying, performing Steps 10 through 13, until there is less than 0.05 percent change after additional drying time.
15. Cool the sample and container to  $\pm 9^\circ\text{C}$  ( $\pm 15^\circ\text{F}$ ) of the temperature determined in Step 4.
16. Determine and record the dry mass of the sample and container to the nearest 0.1 g.
17. Determine and record the mass of dry sample ( $M_f$ ) by subtracting the mass of the container determined in Step 2 from the dry mass of the sample and container determined in Step 16.

**Note 2:** Moisture content and the number of samples in the oven will affect the rate of drying at any given time. Placing wet samples in the oven with nearly dry samples could affect the drying process.

## Calculations

### Constant Mass:

Calculate constant mass using the following formula:

$$\% \text{ Change} = \frac{M_p - M_n}{M_p} \times 100$$

Where:

$M_p$  = previous mass measurement

$M_n$  = new mass measurement

### Example:

Mass of container and release media:	232.6 g
Initial mass of sample and container:	1367.5 g
Initial mass of sample ( $M_i$ ):	$1367.5 \text{ g} - 232.6 \text{ g} = 1134.9 \text{ g}$

ASPHALT

WAQTC

FOP AASHTO T 329 (24)

Mass of sample and container after first drying cycle:	1361.8 g
Mass, $M_p$ , of sample:	$1361.8 \text{ g} - 232.6 \text{ g} = 1129.2 \text{ g}$
Mass of sample and container after second drying cycle:	1360.4 g
Mass, $M_n$ , of sample:	$1360.4 \text{ g} - 232.6 \text{ g} = 1127.8 \text{ g}$

$$\% \text{ Change} = \frac{1129.2 \text{ g} - 1127.8 \text{ g}}{1129.2 \text{ g}} \times 100 = 0.12\%$$

0.12 percent is not less than 0.05 percent, so continue drying the sample.

Mass of sample and container after third drying cycle:	1359.9 g
Mass, $M_n$ , of sample:	$1359.9 \text{ g} - 232.6 \text{ g} = 1127.3 \text{ g}$

$$\% \text{ Change} = \frac{1127.8 \text{ g} - 1127.3 \text{ g}}{1127.8 \text{ g}} \times 100 = 0.04\%$$

0.04 percent is less than 0.05 percent, so constant mass has been reached.

### Moisture Content:

Calculate the moisture content, as a percent, using the following formula.

$$\text{Moisture Content} = \frac{M_i - M_f}{M_f} \times 100$$

Where:

$M_i$  = initial, wet mass

$M_f$  = final, dry mass

### Example:

$M_i$  = 1134.9 g

$M_f$  = 1127.3 g

$$\text{Moisture Content} = \frac{1134.9 \text{ g} - 1127.3 \text{ g}}{1127.3 \text{ g}} \times 100 = 0.674, \text{ report } 0.67\%$$

ASPHALT

WAQTC

FOP AASHTO T 329 (24)

**Report**

- On forms approved by the agency
- Sample ID
- Moisture content to the nearest 0.01 percent



ASPHALT

WAQTC

FOP AASHTO T 329 (09)

**PERFORMANCE EXAM CHECKLIST**

**MOISTURE CONTENT OF ASPHALT MIXTURES BY OVEN METHOD  
FOP FOR AASHTO T 329**

Participant Name \_\_\_\_\_ Exam Date \_\_\_\_\_

Record the symbols "P" for passing or "F" for failing on each step of the checklist.

<b>Procedure Element</b>	<b>Trial 1</b>	<b>Trial 2</b>
1. Mass of clean dry container including release media determined to 0.1 g?	_____	_____
2. Representative sample obtained; 1000 g minimum?	_____	_____
3. Initial temperature taken and recorded?	_____	_____
4. Mass of sample determined to the nearest 0.1 g?	_____	_____
5. Sample placed in drying oven for 90 ±5 minutes?	_____	_____
6. Sample dried at a temperature not to exceed the JMF (if known) mixing temp or 163 ±14°C (325 ±25°F)?	_____	_____
7. Constant mass checked at 30 ±5 minute intervals and reached?	_____	_____
8. Sample and container cooled to ±9°C (15°F) of the initial temperature before final dry mass determined to 0.1 g?	_____	_____
9. Calculation of moisture content performed correctly to 0.01 percent?	_____	_____

$$Moisture\ Content = \frac{M_i - M_f}{M_f} \times 100$$

Comments: First attempt: Pass \_\_\_\_\_ Fail \_\_\_\_\_ Second attempt: Pass \_\_\_\_\_ Fail \_\_\_\_\_

\_\_\_\_\_

\_\_\_\_\_

\_\_\_\_\_

\_\_\_\_\_

\_\_\_\_\_

**Examiner Signature** \_\_\_\_\_ **WAQTC #:** \_\_\_\_\_

ASPHALT

WAQTC

FOP AASHTO T 329 (09)

## **BULK SPECIFIC GRAVITY ( $G_{mb}$ ) AND DENSITY OF COMPACTED ASPHALT MIXTURES USING AUTOMATIC VACUUM SEALING METHOD FOP FOR AASHTO T 331**

### **Scope**

This method covers the determination of bulk specific gravity ( $G_{mb}$ ) of compacted asphalt mixture specimens in accordance with AASHTO T 331-23.

### **Overview**

This method is used when specimens have open or interconnecting voids or absorb more than 2.0 percent of water by volume, or both, according to the FOP for AASHTO T 166.

Bulk specific gravity ( $G_{mb}$ ) determined by this method may be lower, and air voids higher, than the results determined according to the FOP for AASHTO T 166. The differences may be more pronounced for coarse and absorptive mixtures. This procedure should be followed during laboratory mix designing if it will be used for control or assurance testing.

### **Test Specimens**

Test specimens may be either laboratory-molded or sampled from asphalt mixture pavement. For specimens it is recommended that the diameter be equal to four times the maximum size of the aggregate and the thickness be at least one and one half times the maximum size of the aggregate.

### **Terminology**

*Constant Mass:* The state at which a mass does not change more than a given percent, after additional drying for a defined time interval, at a required temperature.

### **Apparatus**

- Bag cutter: knife or scissors
- Balance or scale: 5 kg capacity, readable to 0.1 g, and fitted with a suitable suspension apparatus and holder to permit weighing the specimen while suspended in water, conforming to AASHTO M 231.
- Suspension apparatus: Wire of the smallest practical size and constructed to permit the container to be fully immersed.
- Water bath: For immersing the specimen in water while suspended under the balance or scale and equipped with an overflow outlet for maintaining a constant water level. Thermometer for measuring the temperature of the water bath shall have a temperature range of at least 20 to 45°C (68 to 113°F) and an accuracy of  $\pm 0.25^\circ\text{C}$  ( $\pm 0.45^\circ\text{F}$ )
- Oven: Capable of maintaining a temperature of  $52 \pm 3^\circ\text{C}$  ( $126 \pm 5^\circ\text{F}$ ) for drying the specimens to a constant mass.
- Thermometer for measuring the room temperature: Accurate to  $\pm 0.5^\circ\text{C}$  ( $\pm 0.9^\circ\text{F}$ ) and with a temperature range of at least 15 to 45°C (59 to 113°F)

- Plastic bags: puncture resistant impermeable plastic bags that will not stick to the specimen and capable of withstanding temperatures up to 70°C (158°F). Between 0.127 mm (0.005 in.) and 0.178 mm (0.007 in.) thick. The bag correction factor (apparent specific gravity) is supplied by the manufacturer.
  - Small bag: less than 35 g with an opening between 241 mm (9.50 in.) and 267 mm (10.50 in.)
  - Large bag: 35 g or more with an opening between 368 mm (14.50 in.) and 394 mm (15.5 in.)

*Note 1:* The bag correction factor is usually located in the operator's manual. See the manufacturer's recommendations to ensure proper handling of bags.

- Specimen sliding plates: removable level and smooth-sided planar filler plates shall be inserted into the chamber to keep the samples of various heights level with the seal bar while being sealed.
- Specimen support plate: a plate with a cushioning membrane on top large enough to fully support the specimen and can easily slide on top of the smooth-sided plates.
- Vacuum chamber and sealing device: meeting the requirements of AASHTO T 331
- Vacuum gauge: meeting the requirements of AASHTO T 331

## Procedure

Recently molded laboratory samples that have not been exposed to moisture do not need drying.

1. Dry the specimen to constant mass, if required.
  - a. Oven method
    - i. Initially dry overnight at  $52 \pm 3^\circ\text{C}$  ( $125 \pm 5^\circ\text{F}$ ).
    - ii. Determine and record the mass of the specimen. Designate as  $M_p$ .
    - iii. Return the specimen to the oven for at least 2 hours.
    - iv. Determine and record the mass of the specimen. Designate as  $M_n$ .
    - v. Determine percent change by subtracting the new mass determination,  $M_n$ , from the previous mass determination,  $M_p$ , divide by the previous mass determination,  $M_p$ , and multiply by 100.
    - vi. Continue drying until there is no more than 0.05 percent change in specimen mass after 2-hour drying intervals (constant mass).
    - vii. Constant mass has been achieved; sample is defined as dry.
  - b. Vacuum dry method according to the FOP for AASHTO R 79.
2. Cool the specimen in air to  $25 \pm 5^\circ\text{C}$  ( $77 \pm 9^\circ\text{F}$ ), and determine and record the dry mass to the nearest 0.1 g. Designate this mass as A.

*Note 1:* 3000 to 6000 g laboratory compacted specimens may be considered room temperature after 2 hr. under a fan. Cooling time may be reduced for smaller specimens.

3. Fill the water bath to overflow level with water at  $25 \pm 1^\circ\text{C}$  ( $77 \pm 1.8^\circ\text{F}$ ) and allow the water to stabilize.
4. Seal the specimen.
  - a. Use a large bag for 150 mm (6 in.) in by 50 mm (2 in.) or greater specimens. Use a small bag for smaller specimens.
  - b. Set the heat-sealing bar temperature according to manufacturer's directions.
  - c. Inspect the bag for holes and irregularities.
  - d. Determine and record the mass of the bag. Designate as B.
  - e. Adjust filler plates in the vacuum chamber, adding or removing plates as needed.
  - f. Place specimen support plate on top of filler plates.
  - g. Place the bag on top of the specimen support plate in the vacuum chamber.
  - h. Insert the specimen into the bag with the smoothest plane of the specimen on the bottom.

**Note 2:** Inserting the specimen into the bag may be done inside the chamber while holding the bag open with one hand over the sliding plate and gently inserting the specimen with the other hand. There should be about 25 mm (1 in.) of slack between the presealed bag end and the specimen.

- i. Grab the unsealed end of the bag on each side.
- j. Gently pull and center the bag over the seal bar, overlapping at least 25 mm (1 in.). Ensure that there are no wrinkles in the bag along the seal bar before closing the lid.
- k. Close the lid and engage the lid-retaining latch.

**Note 3:** The vacuum pump light will illuminate "red," and the vacuum gauge on the exterior of the chamber will become active, or a digital reading will show the vacuum state. It is normal for the bag to expand or "puff up" during this process.

- l. Once sealed, the 'de-vac' valve will open, and air will enter the chamber, causing atmospheric pressure to collapse the bag around the specimen.
  - m. Disengage the lid-retaining latch, and carefully remove the sealed specimen from the chamber. Gently pull on the bag where it appears loose. Loose areas indicate a poor seal and the process must then be restarted at Step 4 with a new bag and a new initial mass.
5. Zero or tare the balance with the immersion apparatus attached, ensuring that the device is not touching the sides or the bottom of the water bath.
  6. Fully submerge the specimen and bag shaking to remove the air bubbles. Ensure no air is trapped under the bag or in the bag creases. Place the specimen on its side in the suspension apparatus.
  7. Allow water level and scale to stabilize.
  8. Determine and record the submerged weight to the nearest 0.1 g. Designate this submerged weight as E.

**Note 4:** Complete Steps 4 through 7 in 1 min. or less to reduce potential for bag leaks.

9. Cut the bag open.
10. Remove the specimen from the bag.
11. Determine the mass of the specimen. Designate as C.
12. Compare this mass, C, with initial dry mass determined in Step 2, A.

If more than 0.08 percent is lost or more than 0.04 percent is gained, return to Step 1.

13. Calculate  $G_{mb}$  and record to three decimal places.

### Calculations

Calculate constant mass using the following formula:

$$\%Change = \frac{M_p - M_n}{M_p} \times 100$$

Where:

$M_p$  = previous mass measurement, g

$M_n$  = new mass measurement, g

Calculate the bulk specific gravity ( $G_{mb}$ ) using the following formula:

$$G_{mb} = \frac{A}{C + B - E - \left(\frac{B}{F}\right)}$$

Where:

$G_{mb}$  = bulk specific gravity

A = mass of dry specimen in air, g

B = mass of the bag in air, g

C = final mass of the specimen after removal from the sealed bag, g

E = mass of the sealed specimen underwater, g

F = bag correction factor (apparent specific gravity), provided by the bag manufacturer

**Example**

$$G_{mb} = \frac{4833.6 \text{ g}}{4833.6 \text{ g} + 50.2 \text{ g} - 2860.4 \text{ g} - \left(\frac{50.2 \text{ g}}{0.756}\right)} = 2.470$$

Given:

A	=	4833.6 g
B	=	50.2 g
C	=	4833.6 g
E	=	2860.4 g
F	=	0.756

**Report**

- Results on forms approved by the agency
- Sample ID
- $G_{mb}$  to the nearest 0.001





PERFORMANCE EXAM CHECKLIST

BULK SPECIFIC GRAVITY (G<sub>mb</sub>) AND DENSITY OF COMPACTED ASPHALT MIXTURES USING AUTOMATIC VACUUM SEALING METHOD FOP FOR AASHTO T 331

Participant Name \_\_\_\_\_ Exam Date \_\_\_\_\_

Record the symbols "P" for passing or "F" for failing on each step of the checklist.

Procedure Element	Trial 1	Trial 2
1. Specimen dried to constant mass if required?	_____	_____
2. Specimen cooled to 25 ±5°C (77 ±9°F)?	_____	_____
3. Dry mass determined?	_____	_____
4. Water bath filled to overflow level with 25 ±1°C (77 ±1.8°F) water and stabilized?	_____	_____
5. Specimen sealed in appropriate bag?	_____	_____
6. Balance tared with the immersion apparatus attached and not touching the sides or the bottom of the water bath?	_____	_____
7. Fully submerged specimen and bag shaken to remove the air bubbles?	_____	_____
8. Water level and balance stabilized?	_____	_____
9. Submerged weight determined to the nearest 0.1 g?	_____	_____
10. Specimen revived from bag and mass determined?	_____	_____
11. Dry masses agree within appropriate range?	_____	_____
12. G <sub>mb</sub> calculated and reported correctly?	_____	_____

Comments: First attempt: Pass \_\_\_\_\_ Fail \_\_\_\_\_ Second attempt: Pass \_\_\_\_\_ Fail \_\_\_\_\_

---



---



---



---



---



---



---

Examiner Signature \_\_\_\_\_ WAQTC #: \_\_\_\_\_



# WSDOT Errata to FOP for AASHTO T 335

## Determining the Percentage of Fracture in Coarse Aggregate

WAQTC FOP for AASHTO T 335 has been adopted by WSDOT with the following changes:

### Sampling and Sample Preparation

- Method 1 – Combined Fracture Determination

**Table 1 Sample Size Method 1 (Combined Sieve Fracture)** – *Shall conform to the following table and nominal maximum size definition.*

**TABLE 1**  
**Sample Size**  
**Method 1 (Combined Sieve Fracture)**

Nominal Maximum Size* mm (in.)	Minimum Cumulative Sample Mass Retained on 4.75 mm (No. 4) Sieve g (lb)
37.5 (1 1/2)	2500 (6)
25.0 (1)	1500 (3.5)
19.0 (3/4)	1000 (2.5)
12.5 (1/2)	700 (1.5)
9.5 (3/8)	400 (0.9)
4.75 (No. 4)	200 (0.4)

\*For Aggregate, the nominal maximum size sieve is the largest standard sieve opening listed in the applicable specification upon which more than 1-percent of the material by weight is permitted to be retained. For concrete aggregate, the nominal maximum size sieve is the smallest standard sieve opening through which the entire amount of aggregate is permitted to pass.

- Method 2 – Individual Sieve Fracture Determination – *Method not recognized by WSDOT.*



## DETERMINING THE PERCENTAGE OF FRACTURE IN COARSE AGGREGATE FOP FOR AASHTO T 335

### Scope

This procedure covers the determination of the percentage, by mass, of a coarse aggregate (CA) sample that consists of fractured particles meeting specified requirements in accordance with AASHTO T 335-09.

In this FOP, a sample of aggregate is screened on the sieve separating CA and fine aggregate (FA). This sieve will be identified in the agency's specifications but might be the 4.75 mm (No. 4) sieve. CA particles are visually evaluated to determine conformance to the specified fractured criteria. The percentage of conforming particles, by mass, is calculated for comparison to the specifications.

### Apparatus

- Balance or scale: Capacity sufficient for the principal sample mass, accurate to 0.1 percent of the sample mass or readable to 0.1 g and meeting the requirements of AASHTO M 231.
- Sieves: Meeting requirements of the FOP for AASHTO T 27/T 11.
- Splitter: Meeting the requirements of FOP for AASHTO R 76.

### Terminology

1. Fractured criteria: The specified requirement for fractured particles determined by each agency.
2. Fractured face: An angular, rough, or broken surface of an aggregate particle created by crushing or by other means. A face is considered a "fractured face" whenever one-half or more of the projected area, when viewed normal to that face, is fractured with sharp and well-defined edges. This excludes small nicks.
3. Fractured particle: A particle of aggregate having at least the minimum number of fractured faces specified. (This is usually one or two.)

### Sampling and Sample Preparation

1. Sample and reduce the aggregate in accordance with the FOPs for AASHTO R 90 and R 76.
2. When the specifications list only a total fracture percentage, the sample shall be prepared in accordance with Method 1. When the specifications require that the fracture be counted and reported on each sieve, the sample shall be prepared in accordance with Method 2.
3. Method 1 - Combined Fracture Determination
  - a. Dry and cool the sample, if necessary, to sufficiently obtain a clean separation of FA and CA material in the sieving operation.

- b. Sieve the sample in accordance with the FOP for AASHTO T 27/ T 11 over the 4.75 mm (No. 4) sieve, or the appropriate sieve listed in the agency's specifications for this material.

**Note 1:** Where necessary, wash the sample over the sieve designated for the determination of fractured particles to remove any remaining fine material, and dry to a constant mass in accordance with the FOP for AASHTO T 255.

- c. Reduce the sample using Method A – Mechanical Splitter, in accordance with the FOP for AASHTO R 76, to the appropriate test size. This test size should be slightly larger than shown in Table 1, to account for loss of fines through washing if necessary.

**TABLE 1**  
**Sample Size**  
**Method 1 (Combined Sieve Fracture)**

Nominal Maximum Size* mm (in.)	Minimum Cumulative Sample Mass Retained on 4.75 mm (No. 4) Sieve g (lb)
37.5 (1 1/2)	2500 (6)
25.0 (1)	1500 (3.5)
19.0 (3/4)	1000 (2.5)
12.5 (1/2)	700 (1.5)
9.5 (3/8)	400 (0.9)
4.75 (No. 4)	200 (0.4)

\* One sieve larger than the first sieve to retain more than 10 percent of the material using an agency specified set of sieves based on cumulative percent retained. Where large gaps in specification sieves exist, intermediate sieve(s) may be inserted to determine nominal maximum size.

#### 4. Method 2 – Individual Sieve Fracture Determination

- a. Dry and cool the sample, if necessary, to sufficiently obtain a clean separation of FA and CA material in the sieving operation. A washed sample from the gradation determination (the FOP for AASHTO T 27/T 11) may be used.
- b. If not, sieve the sample in accordance with the FOP for AASHTO T 27 over the sieves listed in the specifications for this material.

**Note 2:** If overload (buffer) sieves are used the material from that sieve must be added to the next specification sieve.

- c. The size of test sample for each sieve shall meet the minimum size shown in Table 2. Utilize the total retained sieve mass or select a representative portion from each sieve mass by splitting or quartering in accordance with the FOP for AASHTO R 76.

**Note 3:** Where necessary, wash the sample over the sieves designated for the determination of fractured particles to remove any remaining fine material, and dry to a constant mass in accordance with the FOP for AASHTO T 255.

**TABLE 2**  
**Sample Size**  
**Method 2 (Individual Sieve Fracture)**

Sieve Size mm (in.)	Minimum Sample Mass g (lb)
31.5 (1 1/4)	1500 (3.5)
25.0 (1)	1000 (2.2)
19.0 (3/4)	700 (1.5)
16.0 (5/8)	500 (1.0)
12.5 (1/2)	300 (0.7)
9.5 (3/8)	200 (0.5)
6.3 (1/4)	100 (0.2)
4.75 (No. 4)	100 (0.2)
2.36 (No. 8)	25 (0.1)
2.00 (No. 10)	25 (0.1)

**Note 4:** If fracture is determined on a sample obtained for gradation, use the mass retained on the individual sieves, even if it is less than the minimum listed in Table 2. If less than 5 percent of the total mass is retained on a single specification sieve, include that material on the next smaller specification sieve. If a smaller specification sieve does not exist, this material shall not be included in the fracture determination.

### Procedure

1. After cooling, spread the dried sample on a clean, flat surface.
2. Examine each particle face and determine if the particle meets the fractured criteria.
3. Separate the sample into three categories:
  - Fractured particles meeting the criteria
  - Particles not meeting the criteria
  - Questionable or borderline particles
4. Determine the dry mass of particles in each category to the nearest 0.1 g.
5. Calculate the percent questionable particles to the nearest 1 percent.
6. Re-sort the questionable particles when more than 15 percent is present. Continue sorting until there is no more than 15 percent in the questionable category.
7. Calculate the percent fractured particles meeting criteria to nearest 0.1 percent. Report to 1 percent.

**Calculation**

Calculate the percent questionable particles to the nearest 1 percent using the following formula:

$$\%Q = \frac{Q}{F + Q + N} \times 100$$

Where:

- %Q = Percent of questionable particles
- F = Mass of fractured particles
- Q = Mass of questionable or borderline particles
- N = Mass of unfractured particles

**Example:**

$$\%Q = \frac{97.6 \text{ g}}{632.6 \text{ g} + 97.6 \text{ g} + 352.6 \text{ g}} \times 100 = 9\%$$

Given:

- F = 632.6 g
- Q = 97.6 g
- N = 352.6 g

Calculate the percent fractured particles to the nearest 0.1 percent using the following formula:

$$P = \frac{\frac{Q}{2} + F}{F + Q + N} \times 100$$

Where:

- P = Percent of fractured particles
- F = Mass of fractured particles
- Q = Mass of questionable particles
- N = Mass of unfractured particles



AGGREGATE

WAQTC

FOP AASHTO T 335 (23)

**Example:**

$$P = \frac{\frac{97.6 \text{ g}}{2} + 632.6 \text{ g}}{632.6 \text{ g} + 97.6 \text{ g} + 352.6 \text{ g}} \times 100 = 62.9\% \quad \text{Report 63\%}$$

Given:

$$F = 632.6 \text{ g}$$

$$Q = 97.6 \text{ g}$$

$$N = 352.6 \text{ g}$$

**Report**

- On forms approved by the agency
- Sample ID
- Fractured particles to the nearest 1 percent.

AGGREGATE

WAQTC

FOP AASHTO T 335 (23)

**PERFORMANCE EXAM CHECKLIST**

**DETERMINING THE PERCENTAGE OF FRACTURE IN COARSE AGGREGATE FOP FOR AASHTO T 335**

Participant Name \_\_\_\_\_ Exam Date \_\_\_\_\_

Record the symbols "P" for passing or "F" for failing on each step of the checklist.

Procedure Element	Trial 1	Trial 2
1. Sample dried and cooled, if necessary?	_____	_____
2. Sample properly sieved through specified sieve(s)?	_____	_____
3. Sample reduced to correct size?	_____	_____
4. Each particle examined to determine if the particle meets the fractured criteria?	_____	_____
5. Particles separated into fractured, unfractured, and questionable categories?	_____	_____
6. Dry mass of each category determined to nearest 0.1 g?	_____	_____
7. Questionable category resorted if more than 15 percent of total mass falls in that category?	_____	_____
8. Fractured calculation performed correctly?	_____	_____

Comments: First attempt: Pass \_\_\_\_\_ Fail \_\_\_\_\_ Second attempt: Pass \_\_\_\_\_ Fail \_\_\_\_\_

---



---



---



---



---



---



---



---



---



---

Examiner Signature \_\_\_\_\_ WAQTC #: \_\_\_\_\_

AGGREGATE

WAQTC

FOP AASHTO T 335 (23)

# WSDOT Errata to FOP for AASHTO T 355

## *In-Place Density of Asphalt Mixtures by Nuclear Methods*

WAQTC FOP for AASHTO T 355 has been adopted by WSDOT with the following changes:

### Material

Filler material: *Not used by WSDOT, unless SMA is being placed, then use filler material as described.*

### Test Site Location

*Replace step 1 with below:*

1. WSDOT requires test location selected per WSDOT Test Method 716.

### Procedure

**Method A – Average of two one-minute tests** - *Not recognized by WSDOT use Method B:*

### Calculation of Results

Percent (%) compaction is determined by comparing the in-place wet density as determined by this method to the average Theoretical Maximum Density of the asphalt mixture as determined by WSDOT SOP 729.

Use the following equations to calculate the percent of compaction:

1. Calculate the corrected gauge reading to the nearest tenth as follows:

$$\text{Corrected Gauge Reading} = \text{Wet Density} \times \text{Gauge Correlation Factor}$$

#### **Method B Example:**

Reading:	140.8 lb/ft <sup>3</sup>
Gauge correlation factor:	× 1.015
Corrected reading =	142.9 lb/ft <sup>3</sup>

2. Calculate the percent compaction to the nearest tenth as follows.

$$\% \text{ Compaction} = \frac{\text{Corrected Reading}}{\text{Maximum Density}} \times 100$$

#### **% Compaction Example:**

Corrected reading:	142.9 lb/ft <sup>3</sup>
Maximum Density:	2.466

$$\text{Theoretical Maximum Density} = 2.466 \times 62.245 \text{ lb/ft}^3 = 153.5 \text{ lb/ft}^3$$

$$\% \text{ Compaction} = \frac{142.9 \text{ lb/ft}^3}{153.5 \text{ lb/ft}^3} \times 100 = 93.1\%$$

## APPENDIX – CORRELATION WITH CORES

### Correlation with Cores

*Replace steps 2 and 4 with below:*

2. Obtain a pavement core from each of the test sites according to WSDOT SOP 734. The core should be taken from the center of the nuclear gauge footprint.
4. Determine and calculate gauge correlation factor according to WSDOT SOP 730.



## IN-PLACE DENSITY OF ASPHALT MIXTURES BY NUCLEAR METHODS FOP FOR AASHTO T 355

### Scope

This test method describes a procedure for determining the density of asphalt mixtures by means of a nuclear gauge using the backscatter method in accordance with AASHTO T 355-22. Correlation with densities determined under the FOP for AASHTO T 166 is required by some agencies.

### Apparatus

- Nuclear density gauge with the factory-matched standard reference block.
- Transport case for properly shipping and housing the gauge and tools.
- Instruction manual for the specific make and model of gauge.
- Radioactive materials information and calibration packet containing:
  - Daily standard count log
  - Factory and laboratory calibration data sheet
  - Leak test certificate
  - Shippers' declaration for dangerous goods
  - Procedure memo for storing, transporting, and handling nuclear testing equipment
  - Other radioactive materials documentation as required by local regulatory requirements

### Material

- Filler material: Fine-graded sand from the source used to produce the asphalt pavement or other agency approved materials.

### Radiation Safety

This method does not purport to address all of the safety problems associated with its use. This test method involves potentially hazardous materials. The gauge utilizes radioactive materials that may be hazardous to the health of the user unless proper precautions are taken. Users of this gauge must become familiar with the applicable safety procedures and governmental regulations. All operators will be trained in radiation safety before operating nuclear density gauges. Some agencies require the use of personal monitoring devices such as a thermoluminescent dosimeter or film badge. Effective instructions, together with routine safety procedures such as source leak tests, recording and evaluation of personal monitoring device data, etc., are a recommended part of the operation and storage of this gauge.

## Calibration

Calibrate the nuclear gauge as required by the agency. This calibration may be performed by the agency using the manufacturer's recommended procedures or by other facilities approved by the agency. Verify or re-establish calibration curves, tables, or equivalent coefficients every 12 months.

## Standardization

1. Turn the gauge on and allow it to stabilize (approximately 10 to 20 minutes) before standardization. Leave the power on during the day's testing.
2. Standardize the nuclear gauge at the construction site at the start of each day's work and as often as deemed necessary by the operator or agency. Daily variations in standard count shall not exceed the daily variations established by the manufacturer of the gauge. If the daily variations are exceeded after repeating the standardization procedure, the gauge should be repaired, recalibrated, or both.
3. Record the standard count for both density and moisture in the daily standard count log. The exact procedure for standard count is listed in the manufacturer's Operator's Manual.

*Note 1:* New standard counts may be necessary more than once a day. See agency requirements.

## Test Site Location

1. Select a test location(s) randomly and in accordance with agency requirements. Test sites should be relatively smooth and flat and meet the following conditions:
  - a. At least 10 m (30 ft.) away from other sources of radioactivity.
  - b. At least 3 m (10 ft.) away from large objects.
  - c. If the gauge will be closer than 600 mm (24 in.) to any vertical mass, or less than 300 mm (12 in.) from a vertical pavement edge, use the gauge manufacturer's correction procedure.

## Procedure

1. Maintain maximum contact between the base of the gauge and the surface of the material under test.
2. Use filler material to fill surface voids.
3. Spread a small amount of filler material over the test site surface and distribute it evenly. Strike off the surface with a straightedge (such as a lathe or flat-bar steel) to remove excess material.
4. If using thin-layer mode, enter the anticipated overlay thickness into the gauge.

*Note 2:* If core correlation is required, entered thickness, anticipated thickness, and nominal core thickness may be required to match.



**Method A – Average of two one-minute tests**

1. Place the gauge on the test site, perpendicular to the roller passes.
2. Using a crayon (not spray paint), mark the outline or footprint of the gauge.
3. Extend the source rod to the backscatter position.
4. Take a one-minute test and record the wet density reading.
5. Rotate the gauge 90 degrees centered over the original footprint. Mark the outline or footprint of the gauge.
6. Take another one-minute test and record the wet density reading.
7. If the difference between the two one-minute tests is greater than  $40 \text{ kg/m}^3$  ( $2.5 \text{ lb/ft}^3$ ), retest in both directions. If the difference of the retests is still greater than  $40 \text{ kg/m}^3$  ( $2.5 \text{ lb/ft}^3$ ) test at 180 and 270 degrees.
8. The density reported for each test site shall be the average of the two individual one-minute wet density readings.

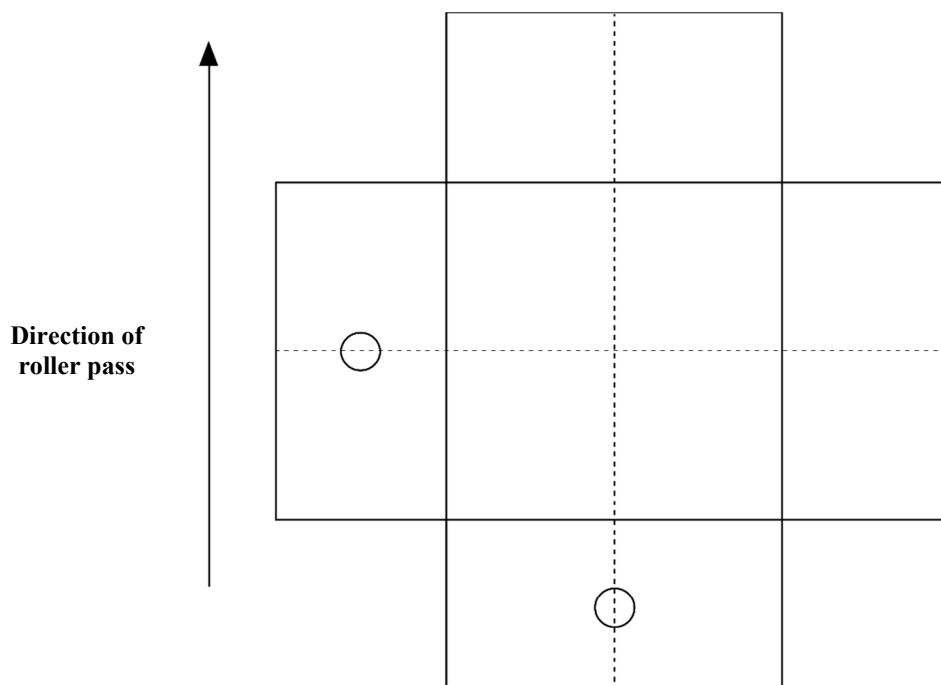
**Method A****Footprint of the gauge test site**

**Method B – One four-minute test**

1. Place the gauge on the test site, parallel to the roller passes.
2. Using a crayon (not spray paint), mark the outline or footprint of the gauge.
3. Extend the source rod to the backscatter position.
4. Take one 4-minute test and record the wet density reading.

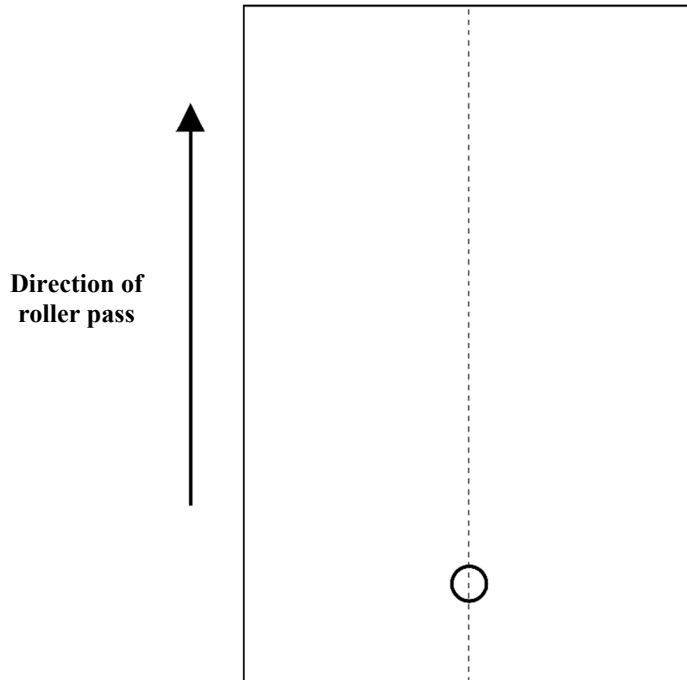

**Method B**  
**Footprint of the gauge test site**

EMBANKMENT AND BASE  
IN-PLACE DENSITY

WAQTC

FOP AASHTO T 355 (22)

### Calculation of Results

Percent (%) compaction is determined by comparing the in-place wet density as determined by this method to the appropriate agency density standard. See appropriate agency policy for use of density standards.

$$\% \text{ Compaction} = \frac{\text{Corrected Reading}}{\text{Maximum Density}} \times 100$$

#### Method A Example:

Reading #1: 141.5 lb/ft<sup>3</sup>

Reading #2: 140.1 lb/ft<sup>3</sup> Are the two readings within the tolerance? (YES)

Reading average: 140.8 lb/ft<sup>3</sup>

Core correction: +2.1 lb/ft<sup>3</sup>

Corrected reading: 142.9 lb/ft<sup>3</sup>

#### Method B Example:

Reading: 140.8 lb/ft<sup>3</sup>

Core correction: +2.1 lb/ft<sup>3</sup>

Corrected reading 142.9 lb/ft<sup>3</sup>

#### Example percent (%) compaction:

From the FOP for AASHTO T 209:

$$G_{mm} = 2.466$$

$$\text{Theoretical Maximum Density} = 2.466 \times 62.245 \text{ lb/ft}^3 = 153.5 \text{ lb/ft}^3$$

$$\% \text{ Compaction} = \frac{142.9 \text{ lb/ft}^3}{153.5 \text{ lb/ft}^3} \times 100 = 93.1\%$$

**Report**

- On forms approved by the agency
- Test ID
- Location of test and thickness of layer tested
- Mixture type
- Make, model and serial number of the nuclear moisture-density gauge
- Calculated wet density of each measurement and any adjustment data
- Density standard
- Compaction to the nearest 0.1 percent
- Name and signature of operator

**APPENDIX – CORRELATION WITH CORES**

(Nonmandatory Information)

The bulk specific gravity ( $G_{mb}$ ) of the core is a physical measurement of the in-place asphalt mixture and can be compared with the nuclear density gauge readings. Comparing the core value to the corresponding gauge values, a correlation can be established.

The correlation can then be used to adjust the gauge readings to the in-place density of the cores. The core correlation is gauge specific and must be determined without traffic allowed on the pavement between nuclear density gauge readings and obtaining the core. When using multiple nuclear density gauges each gauge should be correlated to the core locations before removal of the core.

When density correlation with the FOP for AASHTO T 166 is required, correlation of the nuclear gauge with pavement cores shall be made on the first day's paving (within 24 hours) or from a test strip constructed before the start of paving. Cores must be taken before traffic is allowed on the pavement.

**Correlation with Cores**

1. Determine the number of cores required for correlation from the agency's specifications. Cores shall be located on the first day's paving or on the test strip. Locate the test sites in accordance with the agency's specifications. Follow the "Procedure" section above to establish test sites and obtain densities using the nuclear gauge.
2. Obtain a pavement core from each of the test sites according to AASHTO R 67. The core should be taken from the center of the nuclear gauge footprint.

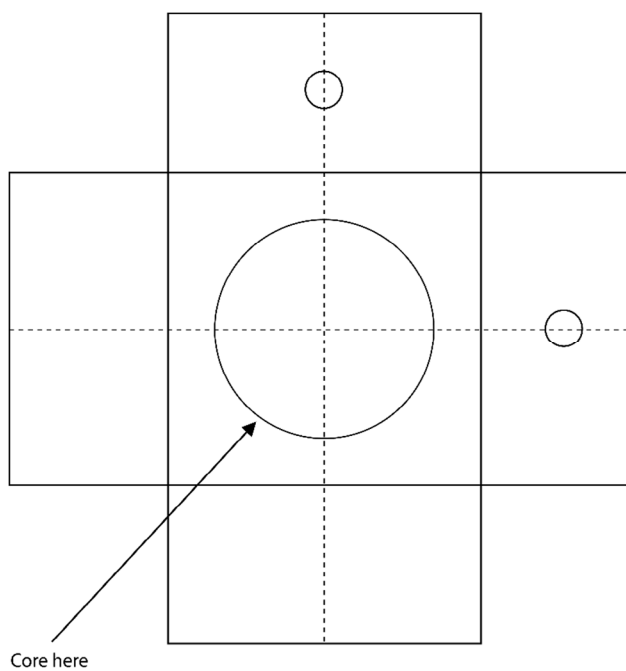

**Method A – Footprint of the gauge test site. Core location in the center of the footprint.**

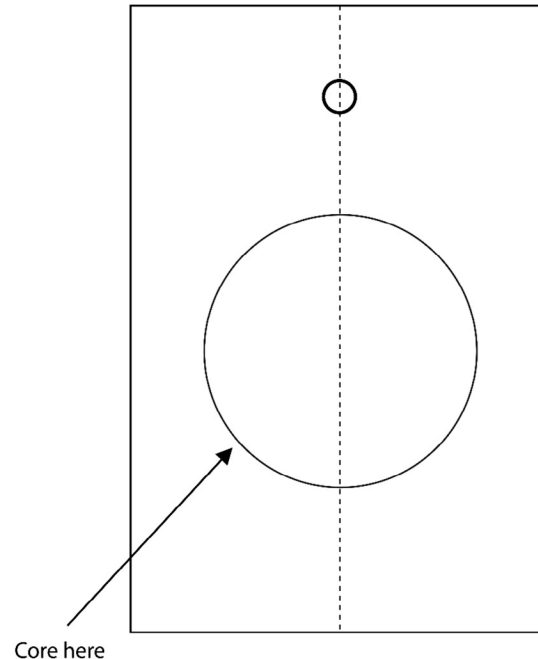

**Method B - Footprint of the gauge test site.**

3. Determine the density of the cores by the FOP for AASHTO T 166, Bulk Specific Gravity of Compacted Asphalt Mixtures Using Saturated Surface Dry Specimens.
4. Calculate a correlation factor for the nuclear gauge reading as follows:
  - a. Calculate the difference between the core density and the average nuclear gauge density at each test site to the nearest  $1 \text{ kg/m}^3$  ( $0.1 \text{ lb/ft}^3$ ). Calculate the average difference and standard deviation of the differences for the entire data set to the nearest  $1 \text{ kg/m}^3$  ( $0.1 \text{ lb/ft}^3$ ).
  - b. If the standard deviation of the differences is equal to or less than  $40 \text{ kg/m}^3$  ( $2.5 \text{ lb/ft}^3$ ), the correlation factor applied to the average nuclear gauge density shall be the average difference calculated above in 4.a.
  - c. If the standard deviation of the differences is greater than  $40 \text{ kg/m}^3$  ( $2.5 \text{ lb/ft}^3$ ), the test site with the greatest variation from the average difference shall be eliminated from the data set and the data set properties and correlation factor recalculated following 4.a and 4.b.
  - d. If the standard deviation of the modified data set still exceeds the maximum specified in 4.b, additional test sites will be eliminated from the data set and the data set properties and correlation factor recalculated following 4.a and 4.b. If the data set consists of less than five test sites, additional test sites shall be established.

**Note A1:** The exact method used in calculating the nuclear gauge correlation factor shall be defined by agency policy.

**Note A2:** The above correlation procedure must be repeated if there is a new job mix formula. Adjustments to the job mix formula beyond tolerances established in the contract documents will constitute a new

EMBANKMENT AND BASE  
IN-PLACE DENSITY

## WAQTC

## FOP AASHTO T 355 (22)

job mix formula. A correlation factor established using this procedure is only valid for the particular gauge used in the correlation procedure. If another gauge is brought onto the project, it shall be correlated using the same procedure. Multiple gauges may be correlated from the same series of cores if done at the same time.

**Note A3:** For the purpose of this procedure, a job mix formula is defined as the percent and grade of paving asphalt used with a specified gradation of aggregate from a designated aggregate source. A new job mix formula may be required whenever compaction of the wearing surface exceeds the agency's specified maximum density or minimum air voids.

## Calculations

### Correlation Factor

$$\sqrt{\frac{\sum x^2}{n-1}}$$

Where:

$\Sigma$  = Sum

x = Difference from the average Difference

n-1 = number of data sets minus 1

### Example

Core #	Core results from T 166:	Average Gauge reading	Difference:	x	x <sup>2</sup>
1	144.9 lb/ft <sup>3</sup>	142.1 lb/ft <sup>3</sup>	2.8 lb/ft <sup>3</sup>	-0.7	0.49
2	142.8 lb/ft <sup>3</sup>	140.9 lb/ft <sup>3</sup>	1.9 lb/ft <sup>3</sup>	0.2	0.04
3	143.1 lb/ft <sup>3</sup>	140.7 lb/ft <sup>3</sup>	2.4 lb/ft <sup>3</sup>	-0.3	0.09
4	140.7 lb/ft <sup>3</sup>	138.9 lb/ft <sup>3</sup>	1.8 lb/ft <sup>3</sup>	0.3	0.09
5	145.1 lb/ft <sup>3</sup>	143.6 lb/ft <sup>3</sup>	1.5 lb/ft <sup>3</sup>	0.6	0.36
6	144.2 lb/ft <sup>3</sup>	142.4 lb/ft <sup>3</sup>	1.8 lb/ft <sup>3</sup>	0.3	0.09
7	143.8 lb/ft <sup>3</sup>	141.3 lb/ft <sup>3</sup>	2.5 lb/ft <sup>3</sup>	-0.4	0.16
8	142.8 lb/ft <sup>3</sup>	139.8 lb/ft <sup>3</sup>	3.0 lb/ft <sup>3</sup>	0.9	0.81
9	144.8 lb/ft <sup>3</sup>	143.3 lb/ft <sup>3</sup>	1.5 lb/ft <sup>3</sup>	-0.6	0.36
10	143.0 lb/ft <sup>3</sup>	141.0 lb/ft <sup>3</sup>	2.0 lb/ft <sup>3</sup>	-0.1	<u>0.01</u>
Average Difference:			+2.1 lb/ft <sup>3</sup>	$\Sigma x^2$	= 2.5

EMBANKMENT AND BASE  
IN-PLACE DENSITY

WAQTC

FOP AASHTO T 355 (22)

**Number of data sets**

$$n - 1 = 10 - 1 = 9$$

**Standard deviation**

$$\text{standard deviation} = \sqrt{\frac{2.5}{9}} = 0.53$$

Given:

$$\text{Sum of } x^2 = 2.5$$

$$\text{Number of data sets} = 9$$

The standard deviation of 0.53 is less than 2.5 therefore no cores are eliminated. The average difference from all ten cores is used.



**PERFORMANCE EXAM CHECKLIST**

**IN-PLACE DENSITY OF ASPHALT MIXTURES BY NUCLEAR METHODS  
FOP FOR AASHTO T 355**

Participant Name \_\_\_\_\_ Exam Date \_\_\_\_\_

Record the symbols "P" for passing or "F" for failing on each step of the checklist.

<b>Procedure Element</b>	<b>Trial 1</b>	<b>Trial 2</b>
1. Gauge turned on approximately 10 to 20 minutes before use?	_____	_____
2. Gauge calibrated, and standard count recorded?	_____	_____
3. Test location selected appropriately [600 mm (24 in.) from vertical projections or 10 m (30 ft.) from any other radioactive sources]?	_____	_____
4. Filler spread evenly over test site?	_____	_____
5. Excess filler material removed by striking off the surface?	_____	_____
6. Gauge placed on pavement surface and footprint of gauge marked?	_____	_____
7. Source rod extended to backscatter position?	_____	_____
8. Method A:		
a. One-minute count taken; gauge rotated 90°, resealed, and another one-minute count taken?	_____	_____
b. Densities averaged?	_____	_____
c. If difference of the wet densities is greater than 40 kg/m <sup>3</sup> (2.5 lb/ft <sup>3</sup> ), retest conducted in both directions?	_____	_____
9. Method B:		
a. One four-minute count taken?	_____	_____
10. Core correlation applied if required?	_____	_____
11. Percent compaction calculated correctly?	_____	_____

Comments:      First attempt:    Pass \_\_\_\_\_ Fail \_\_\_\_\_      Second attempt: Pass \_\_\_\_\_ Fail \_\_\_\_\_

\_\_\_\_\_  
\_\_\_\_\_  
\_\_\_\_\_

Examiner Signature \_\_\_\_\_ WAQTC #: \_\_\_\_\_

IN-PLACE DENSITY

WAQTC

FOP AASHTO T 355 (20)

## WSDOT Test Method T 413

### *Method of Test for Evaluating Waterproofing Effectiveness of Membrane and Membrane-Pavement Systems*

#### 1. Scope

- a. This method describes a procedure for evaluating the waterproofing effectiveness of membranes and membrane-pavement systems as applied to bridge decks. The tests can be performed on the membrane alone or on the membrane-pavement combination.

#### 2. Apparatus

- a. Ohmmeter – Simpson VOM Model 313 or equal; driving voltage for the range of “R × 10K” should be  $1.56 \pm 0.05$  V.; the range of “R × 100K” should be  $1.43 \pm 0.05$  V.
- b. No. 18 Insulated Wire – Belden test probe wire or equivalent, two spools, 250 ft. (76.2 m) each, with connectors.
- c. Metal Contact Plate –  $12 \times 12 \times \frac{1}{8}$  in. (304.8 mm × 304.8 mm × 3.175 mm), with a connection for the ohmmeter and a 36-in. (914.4 mm) nonmetallic handle (see Figure 1, below).
- d. Polyurethane Sponge –  $12 \times 12 \times 1$  in. (304.8 mm × 304.8 mm × 25.4 mm), medium density (see Figure 1, below).

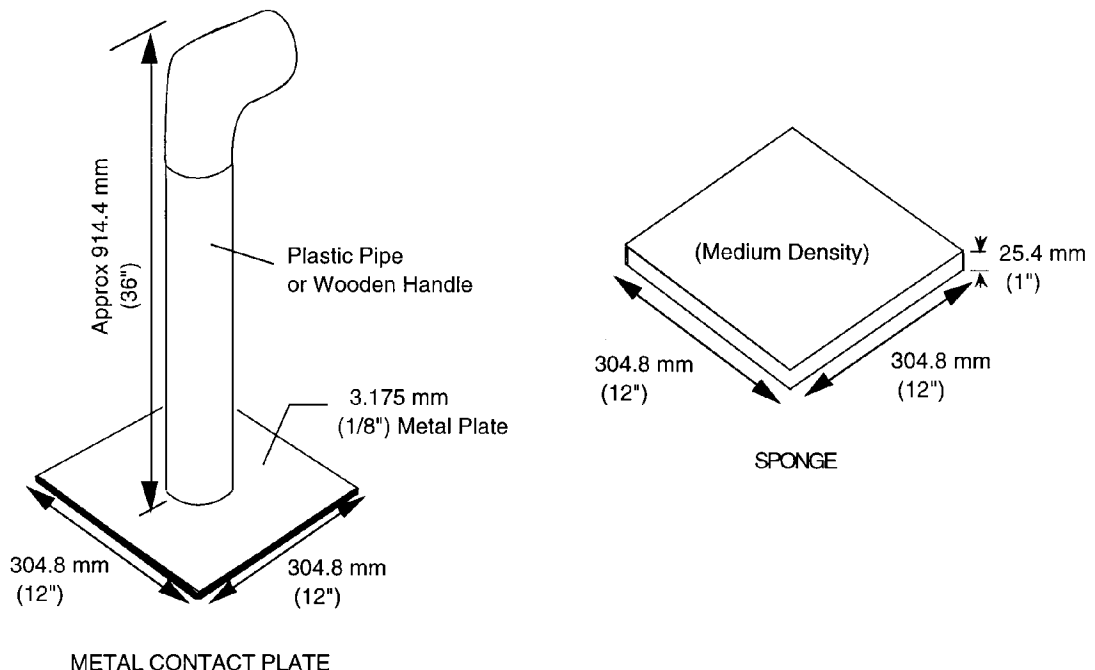

**Figure 1**

- e. Wetting Agent – Aerosol OT (10 percent solution as manufactured by the American Cyanamid Company) or equal; mix 0.4 cup (100 ml) of wetting agent with 5 gal. (18.9 L) of water to make up wetting solution.
- f. Pressure Spray Can – 3 gal. (11.4 L) capacity.
- g.  $\frac{3}{4}$ -in. Stone Cutter's Chisel.
- h. Hammer.
- i. Eye Protection.

**Note:** Items g, h, and i are used for connection to reinforcing steel in deck (negative pole).

### 3. Procedure

The following procedures shall be used **only** when the surface of the membrane-only system is dry or when the membrane-pavement system is judged to be dry internally. The latter condition is an important consideration since moisture will conduct electricity throughout an entire asphalt concrete overlay producing erroneous results at the individual test locations.

#### a. Membrane Only

- (1) When the membrane has cured sufficiently to allow foot traffic on it, divide the bridge deck into a grid pattern similar to that illustrated in Figure 2. The grid spacing shall be as ordered by the Engineer, but it is suggested that the grid lines be spaced at 5 ft. (1.5 m) intervals to provide adequate test coverage. A definite connection to the top mat of reinforcing steel in the bridge deck is desirable; however, if this is not feasible, the bridge railing, expansion joints, light standards, drainage scoupers, or other exposed steel should provide the necessary connection. New bridges are supplied with connection to the reinforcing steel along each edge of the bridge via a junction box.
- (2) Uncoil an ample length of wire to reach the areas to be tested and attach the negative (–) connection of the ohmmeter to the reinforcing steel and the positive (+) connection to the 12 in. × 12 in. by  $\frac{1}{8}$  in. (304.8 mm × 304.8 mm × 3.175 mm) metal contact plate. Check ohmmeter battery for satisfactory charge, then zero the ohmmeter dial indicator.
- (3) Attach the polyurethane sponge to the metal plate with heavy-duty rubber bands and saturate the sponge with the wetting solution.
- (4) In order to check for proper electrical connections and overall equipment operation, prewet two or three areas along the exposed concrete curb and place the measuring device at each location; read and record the resistance readings displayed on the ohmmeter. These readings will normally range from 500 to 8,000 ohms, if the connection to the reinforcing steel is good.
- (5) Once the connections and equipment show proper operation, continue testing at each grid intersection and record the resistance values on photocopies of Figure 3, using blank sheets where additional space is needed.

b. Membrane-Pavement

- (1) New pavement – Procedure steps 3.a.(1) through 3.a.(5) may be used in measuring the resistance of the membrane-pavement system, except that in step 3.a.(5) the test locations should be prewetted with the wetting solution. Only enough wetting solution should be used to saturate the test zone. Surface runoff should be kept to a minimum to prevent interconnecting the test zones electrically.
- (2) Old Pavement – Procedure steps 3.a.(1) through 3.a.(5) may be used in measuring the resistance of the membrane-pavement system, except that in step 3.a.(5) a checkpoint should be selected at a grid intersection that appears dense-graded and well compacted. Saturate the check point with the wetting solution. Keep surface runoff to a minimum to prevent interconnecting the test zones electrically. Take resistance readings at the checkpoint until the value has stabilized at its lowest point. The penetration process should not required more than 15 to 20 minutes. If its takes more than 20 minutes, select a reasonable penetration time and saturate each grid intersection thereafter for that length of time.

**4. Reporting**

- a. Report the resistance values for the exposed membrane and the membrane-pavement system on photostatic copies of Figure 3, using blank sheets where additional space is needed.
- b. Copies of the report are to be submitted to the following offices:
  - (1) Project Engineer (for final records).
  - (2) FOSSC Materials Laboratory (master file).

**5. Acceptance Level**

Refer to the Contract Special Provisions under the section entitled “Membrane Waterproofing (Deck Seal).”

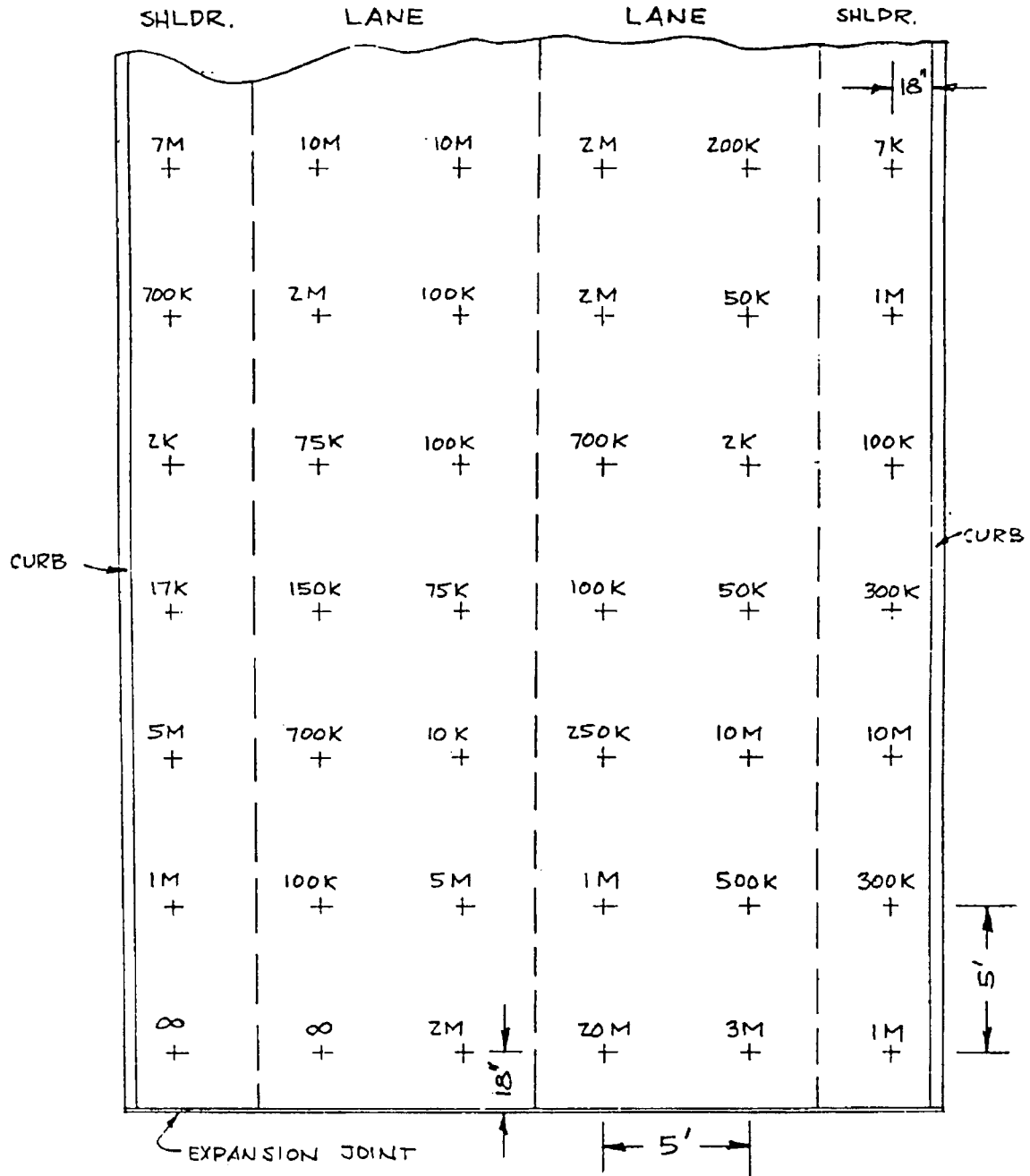

7K = 7,000 OHMS  
 2M = 2,000,000 OHMS  
 ∞ = INFINITE RESISTANCE

Example of Test Grid and Resistance Tabulation  
Figure 2

**ELECTRICAL RESISTIVITY MEASUREMENTS**  
(WDOT Test Method No. 413)

SR \_\_\_\_\_ CONTRACT \_\_\_\_\_ BRIDGE \_\_\_\_\_ BR. NO. \_\_\_\_/\_\_\_\_

TEST PHASE: (Check one) DATE \_\_\_\_/\_\_\_\_/\_\_\_\_

\_\_\_\_\_ MEMBRANE ONLY; TYPE \_\_\_\_\_

\_\_\_\_\_ MEMBRANE-PAVEMENT; PAVT. TYPE \_\_\_\_\_ THCK \_\_\_\_\_ft.

GROUND CHECK RDG. \_\_\_\_\_ohms (avg.) OHMMETER RANGE USED R x \_\_\_\_\_

GRID SPACING \_\_\_\_\_ft. CREW \_\_\_\_\_

\*\*\*BRIDGE & GRID LAYOUT AND MEASUREMENTS\*\*\*

SCALE: VERT. \_\_\_\_\_in. = \_\_\_\_\_ft.; HORIZ. \_\_\_\_\_in. = \_\_\_\_\_ft. NOTE: Use additional sheets  
(blank) if necessary.

**Example of Electrical Resistivity Measurements**  
*Figure 3*







## WSDOT Test Method T 417

### *Method of Test for Determining Minimum Resistivity and pH of Soil and Water*

#### 1. Scope

- a. This method covers the procedure for determining the minimum resistivity and pH of soil or water samples at metal culvert locations. These values are used to assist in determining the type of metal culvert materials and protective coating that are permissible at each location.
- b. This test method is divided into the following parts:
  - (1) Method of field resistivity survey and sampling for laboratory tests.
  - (2) Method of determining pH of water.
  - (3) Method of determining pH of soil.
  - (4) Laboratory method of determining minimum resistivity.

#### 2. Method of Field Resistivity Survey and Sampling for Laboratory Tests

##### a. Scope

The field resistivity test is an indication of the soluble salts in the soil or water; it is used primarily as a guide for selecting samples that will be tested in the laboratory. The natural soil in each channel or culvert location and the structural backfill material are tested by a portable earth resistivity meter, and samples are selected on the basis of these tests. These samples are tested in the laboratory using a soil box to determine the minimum resistivity that will be used in the culvert-type determination.

##### b. Apparatus and Materials

- (1) Portable earth resistivity meter, suitable for rapid in-place determination of soil resistivity.
- (2) Field probe(s).
- (3) Steel starting rod, for making hole (in hard ground) for inserting probe(s).
- (4) Sledgehammer 4 lbs (1.8 kg).
- (5) Distilled, deionized, or other clean water that has a resistivity greater than 20,000 ohm-cm.

##### c. Recording Data

Record test data in a field record book for use in selecting samples and also for use in analyzing laboratory test data.

## d. Test Procedures

- (1) In the channel of a proposed culvert site, insert the field probe into the soil between 6 in (152.4 mm) and 12 in (304.8 mm) and measure the resistivity. Follow the manufacturer's instructions for use of the meter. Remove the field probe and pour about 2 oz (59 ml) of distilled water into the hole.
- (2) Reinsert the probe while twisting to mix the water and soil, then measure the resistivity.
- (3) Withdraw the probe and add an additional 2 oz (59 ml) of distilled water.
- (4) Reinsert the probe and again measure the resistivity of the soil.
- (5) Multiply the lowest probe reading by ten to determine the minimum field soil resistivity and record this result. Note the multiplication factor of **ten** for soil resistivity readings when using the field probe.
- (6) In addition to the single probe method described above another method is available for determination of soil resistivity in the field. Refer to the manufacturer's instructions as well as ASTM G 57 if the 4 probe "Wenner" method is being employed to determine the soil resistivity in the field.

## e. Selection of Soil Samples for Laboratory Tests

- (1) Make sufficient resistivity determinations at various locations in the channel or culvert site area to adequately represent the entire area. Should the soil appear consistent at a test site, take two resistivity determinations to verify. Additional readings should be taken if different soils are present.
- (2) If the resistivity is reasonably uniform within the limits of the project, soil samples from three different locations will be sufficient. If, however, some locations show resistivities that differ significantly from the average of the determinations for the area being surveyed, additional soil samples should be taken to represent these locations – particularly those with resistivities significantly below the average.

For example, if the soil resistivities throughout the surveyed area are all at or near an average value of 20 ohm meter, three samples will be enough. If any of the locations tested have resistivities markedly below this average, for example 8 ohm meter, then such "hot spots" should definitely be represented by additional samples. Scattered locations of higher resistivity, for example 30 ohm meter or more, do not require additional samples.

Judgment must be exercised both in the field testing and sampling, and in evaluating the laboratory tests. In all cases, take a minimum of three samples per project.

Samples should be about 10 lb (4.5 kg) each and should be identified as to material type and location.

### 3. Method of Determining pH of Water

#### a. Scope

This method is suitable for use in the field or laboratory for determining the pH of water samples.

#### b. Apparatus and Materials

- (1) 5 oz. (148 ml) or larger nonmetallic wide-mouth container, e.g., glass jar, beaker, or wax coated paper cup.
- (2) pH meter.
- (3) pH standard solution of pH 7.

#### c. Recording Data

Record test data in a field record book and report the results to the Project Engineer and in the Regional Soils Report.

#### d. Method of Sampling

- (1) To avoid contamination from container, dip the wide-mouth container into the water to be tested, swirl to rinse and pour out contents.
- (2) Dip the container into the water again to obtain a sample.
- (3) Pour off any film which is on the surface of the sample before testing.

#### e. Standardization of pH Meter

Follow the instructions provided with the pH meter.

#### f. Use of pH Meter to Determine pH of Water

Follow the instructions provided with the pH meter.

#### g. Precautions

Follow the manufacturer's instructions for use of the meter and observe the usual precautions for making chemical tests.

**Note:** Field pH readings may be taken at any period other than flood flow. For water which has a pH of less than 6, take a 1 L (minimum) sample for laboratory analysis.

### 4. Laboratory Method of Determining pH OF SOIL

#### a. Scope

This method covers the laboratory procedure for determining pH of soil samples selected as indicated in Section 2.

#### b. Apparatus and Materials

- (1) pH meter suitable for laboratory testing.
- (2) Suitable containers constructed of glass or wax coated paper, with moisture proof covers.
- (3) pH buffer solutions of pH 4.0, 7.0 & 10.0 (or those recommended by the pH meter manufacturer for meter standardization.)
- (4) Distilled water and wash bottle.
- (5) Thermometer (if required) readable to 0.2°F (0.1°C).

- (6) U.S. No. 8 (2.36 mm) sieve.
  - (7) Balance, with sufficient capacity and readable to 0.1% of the sample mass, or better, conforming to the requirements of AASHTO M 231.
  - (8) Oven capable of maintaining a temperature of 140°F(60°C) around sample.
  - (9) Glass stirring rod.
- c. Initial Preparation of Test Samples
- (1) As received samples are to be tested for pH in a “moist” condition. If the soil as received is too wet to facilitate proper screening and reduction to test size it shall be air dried or dried to a “moist” condition in an oven at a temperature not to exceed 140°F (60°C).
  - (2) Split or quarter a sufficient amount of the moist sample to yield approximately 100 g of material after the material has been pulverized or mulled, taking care not to crush rock particles or naturally occurring grains, and screened over a U.S. No. 8 (2.36 mm) sieve. Discard any material retained on the U.S. No. 8 sieve. Only natural material passing the U.S. No. 8 sieve is to be used for the test.
- d. Procedure for pH Determination
- (1) Place a  $30.0 \pm 0.1$  gram sample of prepared soil into the test container.
  - (2) Add  $30.0 \pm 0.1$  grams of distilled water to the soil sample. Stir the sample to obtain a slurry and cover.
  - (3) Allow the sample to stand for a minimum of 1 hour, stirring every 10 to 15 minutes.
  - (4) Standardize the pH meter in accordance with the manufacturer’s instructions.
  - (5) Stir the sample with a glass rod immediately prior to placing the pH meter electrode into the sample. Place the electrode in the sample taking precaution to ensure good contact between the electrode and the soil slurry. DO NOT place the electrode into any soil that may have accumulated in the bottom of the container, only into the soil slurry.
  - (6) Allow the electrode to remain immersed in the soil slurry for a sufficient time for the meter to stabilize. Refer to the manufacturer’s instructions for recommended pH determination procedure and stabilization time.
  - (7) Read and record the pH of the sample to the nearest tenth of a whole number. If the meter reads to the hundredth place it shall be rounded to the nearest tenth place.
  - (8) Clean pH meter electrode and store in accordance with the manufacturer’s instructions.
- e. Precautions
- (1) Follow all manufacturer’s recommendations regarding proper use of the pH meter.
- f. Report
- (1) Report the pH value to the nearest tenth of a whole number.

## 5. Laboratory Method of Determining Minimum Soil Resistivity

### a. Scope

This method covers the procedure for determining the minimum resistivity of soil samples selected as indicated in Section 2.

### b. Apparatus and Materials

- (1) Resistivity meter suitable for laboratory testing.
- (2) Soil box calibrated for use with resistivity meter.
- (3) U.S. No. 8 (2.36 mm) sieve.
- (4) Non-absorbent pans, bowls or other containers of sufficient size to eliminate spilling during mixing, moisture conditioning, and sample handling.
- (5) Oven capable of maintaining a temperature of 140°F (60°C) around sample.
- (6) Balance, with sufficient capacity and readable to 0.1% of the sample mass, or better, and conform to the requirements of AASHTO M 231.
- (7) Distilled or deionized water.
- (8) Spoon or spatula.
- (9) Graduated cylinder or other suitable device of sufficient size to accurately add quantities of moisture to sample.
- (10) Straightedge

### c. Preparation of Soil Samples

- (1) Dry the sample as received from the field to a constant mass at a temperature not to exceed 140°F (60°C). (Air drying is also acceptable.) Split or quarter a sufficient amount of the dried material to yield a suitable sample after the material has been pulverized or mulled, taking care not to crush rock particles or naturally occurring grains, and screened over a U.S. No. 8 (2.36 mm) sieve. Discard any material retained on the U.S. No. 8 sieve. Only natural material passing the U.S. No. 8 sieve is to be used for the test.

### d. Measuring the Resistivity of Soil Sample

- (1) Split or quarter an amount of prepared soil that will fill approximately 4 times the volume of the soil box being utilized to determine resistivity.
- (2) Add approximately 10% by weight of distilled water to the sample and mix thoroughly. Allow the sample to stand in a moisture proof container for a minimum of 12 hours.
- (3) Re-mix the sample and immediately compact it (moderate compaction with the fingers is sufficient) slightly over the top of the soil box that has been cleaned with distilled water prior to use. Strike the material level to the top of the soil box with a straightedge.
- (4) Measure the resistivity of the soil in accordance with the instructions furnished with the meter *and record the value*.
- (5) Remove the soil from the soil box and recombine it with the remainder of the original sample then add an additional 5% by *original dry soil weight* of distilled water and thoroughly mix.

- (6) Rinse the soil box with distilled water then immediately place the soil in the soil box and compact as described in step 3.
- (7) Measure the resistivity of the soil in accordance with the instructions furnished with the meter and record the value.
- (8) Repeat steps 5 through 7 until a minimum value can be determined.
- (9) Record the lowest value measured during the repeated measurements in the soil box. The multiplication factor for the soil box is one, (*do not assume this as this value should be verified or reconciled with the manufacturer's recommendations provided with the soil box*) so a direct reading of the meter is the value used.
- (10) Report the minimum resistivity of the soil in ohms-cm.

## 6. Laboratory Method of Determining Water Resistivity

### a. Measuring the Resistivity of a Water Sample

- (1) Thoroughly clean the soil box of all soil particles and rinse the soil box a minimum of three times with distilled water.
- (2) Fill the soil box with distilled water and measure its resistivity.
- (3) If the distilled water in the soil box measures infinite resistivity, empty the soil box of distilled water, fill with the test water, measure its resistivity, and record the measured value.
- (4) If the distilled water in the soil box measures less than infinite resistivity, continue to rinse with distilled water until the box is absolutely clean. This condition is indicated by an infinite resistivity measurement when the box is filled with distilled water.

### b. Recording Data

Record data in a field record book and report the results to the Project Engineer and in the Regional Soils Report.

## 7. Minimum Requirements

- a. Metal pipe may be used at locations where the pH and soil resistivity are within the limits specified in the *Hydraulics Manual M 23-01* for Aluminum (Aluminum Coated) Steel Pipe, Aluminum Pipe, and Galvanized (Zinc Coated) Steel Pipe.

## Performance Exam Checklist

### Method T 417 Checklist

#### *Determining Minimum Resistivity and pH of Soil and Water*

Participant Name: \_\_\_\_\_ Exam Date: \_\_\_\_\_

Record the symbols "P" for passing or "F" for failing on each step of the checklist.

Procedure Element	Trial 1	Trial 2
<b>Determining pH of H<sub>2</sub>O</b>		
1. pH meter standardized in accordance with manufacturer's instructions?	_____	_____
2. H <sub>2</sub> O sample placed in suitable non-metallic container for testing?	_____	_____
3. pH of H <sub>2</sub> O determined in accordance with pH meter manufacturer's instructions?	_____	_____
4. pH recorded and reported to the nearest one tenth of a whole number?	_____	_____
<b>Determining pH of soil</b>		
1. Sample dried (if required) to a moist condition at a temperature not to exceed 140°F (60°C)?	_____	_____
2. Sample cooled, pulverized or milled, and screened over a U.S. #8 sieve?	_____	_____
3. Only natural material passing U.S. #8 sieve used for test?	_____	_____
4. Approximately 100 grams of passing #8 material selected for testing?	_____	_____
5. 30 ± 0.1 grams of soil and 30 ± 0.1 grams of distilled H <sub>2</sub> O added to suitable non-metallic testing container?	_____	_____
6. Sample immediately stirred to produce slurry and covered?	_____	_____
7. Sample allowed to stand for 1 hour, stirring every 10 to 15 minutes?	_____	_____
8. pH meter standardized in accordance with manufacturer's instructions?	_____	_____
9. Soil stirred immediately prior to pH determination?	_____	_____
10. pH of soil slurry correctly determined?	_____	_____
11. pH of soil read, rounded (if necessary) and reported to the nearest one tenth of a whole number?	_____	_____

## Procedure Element

Trial 1 Trial 2

**Determining minimum resistivity of soil**

- |   |       |       |
|---|-------|-------|
| 1. As received sample dried to a constant mass at a temperature not to exceed 140°F (60°C)?   | _____ | _____ |
| 2. Sample cooled, pulverized or milled, and screened over a U.S. #8 sieve?  | _____ | _____ |
| 3. Only natural material passing U.S. #8 sieve used for test?   | _____ | _____ |
| 4. Approximately 4 times the volume of the soil box of material passing the U.S. #8 sieve split or quartered for testing?                           | _____ | _____ |
| 5. 10% by weight of distilled H <sub>2</sub> O added to sample?   | _____ | _____ |
| 6. Sample mixed, covered and allowed to stand for a minimum of 12 hours in a moisture proof container?  | _____ | _____ |
| 7. Sample re-mixed, moderately compacted in soil box and resistivity determined?  | _____ | _____ |
| 8. Resistivity value recorded?  | _____ | _____ |
| 9. Sample from soil box removed, placed with remainder of sample and additional 5% by original dry soil weight of distilled H <sub>2</sub> O added? | _____ | _____ |
| 10. Sample remixed and resistivity determined and recorded?   | _____ | _____ |
| 11. Steps 8 and 9 repeated until minimum resistivity can be determined?   | _____ | _____ |
| 12. Minimum resistivity of soil reported in ohms/cm?  | _____ | _____ |

**Determination of H<sub>2</sub>O resistivity.**

- |   |       |       |
|---|-------|-------|
| 1. Soil box thoroughly cleaned and rinsed at least three times with distilled H <sub>2</sub> O? | _____ | _____ |
| 2. Soil box filled level full with distilled H <sub>2</sub> O and resistivity determined?       | _____ | _____ |
| 3. Resistivity from step #2 measures as infinite?   | _____ | _____ |
| 4. If yes, soil box emptied and resistivity of test sample determined and recorded?             | _____ | _____ |
| 5. If no, soil box further cleaned until condition described in step 3 satisfied?               | _____ | _____ |
| 6. Resistivity of H <sub>2</sub> O sample reported in ohms/cm?                                  | _____ | _____ |

Comments: First Attempt: Pass \_\_\_\_\_ Fail \_\_\_\_\_ Second Attempt: Pass \_\_\_\_\_ Fail \_\_\_\_\_

Examiner Signature: \_\_\_\_\_ WAQTC #: \_\_\_\_\_





## WSDOT Test Method T 421

### ***Test Method for NEMA Type Traffic Controller Cabinet, 300 Series (170/2070 Type) Traffic Controller Cabinet, and Advanced Transportation Controller (ATC) Cabinet Inspection***

#### 1. Scope

The purpose of this test method is to document the inspection of Traffic Controller Cabinets to ensure compliance with *Standard Specifications* and Contract Documents.

#### 2. Reference Documents

- WSDOT *Standard Specifications* 9-29.13
- Caltrans Transportation Electrical Equipment Specifications
- FHWA-IP-78-16, Type 170 Signal Controller System Hardware Specification
- NEMA Standards Publication TS-1, Traffic Control Systems
- NEMA Standards Publication TS-2, Traffic Controller Assemblies with NTCIP Requirements
- AASHTO/ITE/NEMA Publication ATC 5301, Advanced Transportation Controller (ATC) Cabinet Standard

#### 3. Safety

There is no PPE required for this test method. All items are visual inspection only, with no power source applied to the Unit Under Test (UUT).

#### 4. Apparatus

An Electro-Static Discharge (ESD) Wrist Strap with cord and alligator clip shall be worn when handling Circuit Card Assemblies (CCA's) to prevent ESD damage. The Wrist Strap shall be connected via the cord and alligator clip to chassis in order to maintain the card handler at the same electrical potential as chassis ground.

#### 5. Procedure

##### 5.1 Incoming Inspection

When the Traffic Controller Cabinet arrives for testing, the contractor representative (typically the contractor's vendor) should have an appointment scheduled. Within seven (7) calendar days of arrival, the contractor representative shall assemble and demonstrate the Traffic Controller Cabinet. If assembly is not completed within these seven (7) calendar days, disposition of the Traffic Controller Cabinet is at the discretion of the Electrical Materials Laboratory personnel. Inspect the Traffic Controller Cabinet for any damage during shipping. Note any deficiencies.

## 5.2 Notify Project Office

Notify the project office and the contractor of the receipt of the Traffic Controller Cabinet. Note all Points-of-Contact who shall be copied on all communications and test results for this project.

## 5.3 Assess Traffic Controller Cabinet Compliance

The contractor representative shall provide all work necessary to assemble the Traffic Controller Cabinet at the State Materials Laboratory. The Traffic Controller Cabinet shall be inspected to ensure that it is in compliance with *Standard Specifications* and Contract Documents. Ensure that all of the required equipment is installed per these *Standard Specifications* and Contract Documents. In the event of a conflict, Contract Documents take precedence over the *Standard Specifications*. The results of successful completion of this test method shall be acceptance for further testing.

At a minimum, the following items shall be inspected against the Contract Documents and *Standard Specifications*:

1. Mylar Prints (cabinet drawings) – verify the minimum quantity per the Contract Documents are supplied by the vendor and that they match the Contract Documents
2. Labeling – verify that all labels match the cabinet drawings
3. Air Filter – verify the correct size, type, and quantity are installed
4. Wiring Laced and Clamped – verify all wiring is secured
5. Field Wire Terminal Blocks – verify correct type is installed
6. Police Keys – verify the correct quantity is supplied, if specified
7. Door Keys – verify the correct quantity is supplied, if specified
8. Door Locks – verify the correct type is installed as specified
9. Police Panel Switches – verify presence as specified
10. Circuit Breakers – verify minimum quantity and rating are installed as specified
11. Transient Suppressor – verify presence and if specified, correct type
12. Modem(s) – verify presence and type, if specified
13. Cabinet Finish – verify correct type, if specified
14. RFI Suppressor – verify presence and if specified, correct type
15. Door Light Switch(es) – verify correct quantity as specified
16. Pedestrian Switches – verify presence and if specified, quantity
17. Cabinet Lights – verify correct quantity and orientation as specified
18. 120 V<sub>ac</sub> Outlet – verify presence as specified
19. Ground Fault Circuit Interruptor – verify presence as specified
20. Equipment Clearance – verify as specified
21. Load Switches – verify quantity and type as specified
22. Intersection Display Panel – verify presence if specified, and match against intersection drawing

23. Cabinet Ground Bus Bar – verify presence as specified
24. Isolated 120 V<sub>ac</sub> bus bar (neutral) – verify presence as specified
25. Phase Selector(s) – verify quantity and type as specified
26. Flash Transfer Relay(s) – verify quantity and type as specified
27. Supplemental Resistor Load – verify presence if specified
28. Two Position Door Stop – verify presence as specified
29. Emergency Indicator Lights – verify presence if specified
30. Railroad Pre-Emption – verify presence if specified
31. Cabinet Construction – verify type if specified
32. Detector Panel – verify presence if specified
33. Detector Panel Shorting Plug (NEMA only) – verify presence if specified
34. Plastic Document Envelope – verify presence if specified
35. External Logic package (NEMA only) – verify presence and type, if specified
36. Absence of Red Assembly (170 and 2070 only) – verify presence of jumper plug area on output file
37. PROM Module (170 only) – verify PROM module is present, if controller is 170 Type
38. Dallas Chips (170 only) – verify Dallas chips, if specified and controller is 170 Type
39. AC Isolator – verify correct quantity and type, if specified
40. DC Isolator – verify correct quantity and type, if specified
41. Aux File (170 and 2070 only) – verify presence and that it is correctly populated per drawing, if specified
42. Manuals and Cut-Sheets – verify the minimum quantity is supplied for each component, if specified in the Contract Documents
43. DB9 Socket and C20 Plug (170 only) – verify presence if specified
44. C2 Plug and Cable (170 only) – verify presence if specified
45. Document Drawer – verify presence as specified
46. Controller – verify quantity and type as specified
47. CMU Door Interlock Switch (170 and 2070 only) – verify presence, if specified
48. Stop Time Switch – verify presence and quantity, if specified
49. Conflict Monitor – verify presence and type as specified
50. Inside Auto/Flash Switch – verify presence, if specified
51. Loop Amplifiers – verify quantity and type, if specified

**6. Report**

Record any deficiency that does not meet the above minimum requirements. Inspection tests shall be recorded in MATS as “As Received” if sufficient, and “As Shipped” if deficient but corrected. Inspection tests that do not apply shall have neither option checked. The overall test result shall be recorded as a “Pass” or “Fail” for test T421 in MATS.

## Performance Exam Checklist

### Method T 421 Checklist

**Test Method for NEMA Type Traffic Controller Cabinet, 300 Series (170/2070 Type) Traffic Controller Cabinet, and Advanced Transportation Controller (ATC) Cabinet Inspection**

Participant Name: \_\_\_\_\_ Exam Date: \_\_\_\_\_

Record the symbols "P" for passing or "F" for failing on each step of the checklist.

Procedure Element	Trial 1	Trial 2
1. Cabinet inspected for damage during shipping.	_____	_____
2. Project Office and Contractor notified of receipt.	_____	_____
3. Traffic Controller Cabinet assessed for compliance.	_____	_____
4. Report.	_____	_____

Comments: First Attempt: Pass \_\_\_\_\_ Fail \_\_\_\_\_ Second Attempt: Pass \_\_\_\_\_ Fail \_\_\_\_\_

Examiner Signature: \_\_\_\_\_ WAQTC #: \_\_\_\_\_





## WSDOT Test Method T 422

### *Test Method for NEMA Type Traffic Controller Cabinet and 300 Series (Type 170/2070) Traffic Controller Cabinet Transient Line Voltage Test (Spike Test)*

#### 1. Scope

The purpose of this test method is to evaluate Traffic Controller Cabinet operation when subjected to Line Voltage Transients of  $300 V_{ac} \pm 5\%$  ( $285 V_{ac}$  to  $315 V_{ac}$ ). This test method only applies to NEMA type Traffic Controller Cabinets and 300 Series (Type 170/2070) Traffic Controller Cabinets.

#### 2. Reference Documents

- Caltrans Transportation Electrical Equipment Specifications
- FHWA-IP-78-16, Type 170 Traffic Signal Controller System Hardware Specification
- NEMA Standards Publication TS-1, Traffic Control Systems
- NEMA Standards Publication TS-2, Traffic Controller Assemblies with NTCIP Requirements

#### 3. Safety

This test is conducted with  $300 V_{ac}$  line transients produced by the Transient Voltage Generator. Safety glasses shall be worn to provide eye protection in the event of an arc flash.

Exercise proper electrical cord handling to reduce the risk of electrical shock.

#### 4. Apparatus

Beckman Model 3020, Berkeley Varitronics Model 3021, or device capable of generating line Voltage transients of  $300 V_{ac}$ .

## 5. Procedure

### 5.1 Setup

Ensure the Transient Voltage Generator Output Control is in the “AC OFF” position and the Traffic Controller Cabinet Main is in the “OFF” position. Connect the Transient Voltage Generator to a 120 V<sub>ac</sub>, 60 Hz power source (standard wall outlet). On the Transient Voltage Generator, set the Meter Control to “Generator Output”, Phase Control to “Auto”, Noise Power to “On”, and Noise Output Level to minimum. Connect the Traffic Controller Cabinet to the Transient Voltage Generator.

### 5.2 Test Execution

Set the Transient Voltage Generator Output Control to “POS Pulse”. Power up the traffic Controller Cabinet. Program the controller to cycle on minimum recall. Ensure the Traffic Controller Cabinet is operating normally.

On the Transient Voltage Generator, adjust the Output Level to 300 V<sub>ac</sub>, ±5% (285 V<sub>ac</sub> to 315 V<sub>ac</sub>). Allow the Traffic Controller Cabinet to run in this configuration for ten minutes. Ensure the Traffic Controller Cabinet is operating normally during these ten minutes.

After the ten minutes has elapsed, adjust the Output Level to minimum on the Transient Voltage Generator. Switch the Output Control to “AC OFF”, wait a moment, then switch to “NEG Pulse”. Ensure that the Traffic Controller Cabinet resumes normal operation.

On the Transient Voltage Generator, adjust the Output Level to 300 V<sub>ac</sub>, ±5% (285 V<sub>ac</sub> to 315 V<sub>ac</sub>). Allow the Traffic Controller to run in this configuration for ten minutes. Ensure the Traffic Controller Cabinet is operating normally during these ten minutes.

After the ten minutes has elapsed, adjust the Output Level to minimum on the Transient Voltage Generator. Switch the Output Control to “AC OFF”. Switch the Traffic Controller Cabinet Main to the “OFF” position.

### 5.3 Test Completion

Disconnect the Traffic Controller Cabinet from the Transient Voltage Generator. Disconnect the Transient Voltage Generator from the 120 V<sub>ac</sub>, 60 Hz power source (standard wall outlet). Return all test equipment to their proper storage location.

## 6. Report

During Test Execution the Traffic Controller Cabinet must conduct normal operation throughout all test conditions. During phase cycling, the Traffic Controller Cabinet shall not skip intervals, it shall not place false calls or produce false indications while in dwell, it shall not disrupt normal sequences in any manner, and it shall not change timings. Any of these conditions is considered a fail.

Record any deficiency that does not meet the above minimum requirements. The overall test result shall be recorded as a “Pass” or “Fail” for test T 422 in MATS.



# Performance Exam Checklist

## Test Method for NEMA Type Traffic Controller Cabinet and 300 Series (Type 170/2070) Traffic Controller Cabinet Transient Line Voltage Test (Spike Test) Method T 422 Checklist

Participant Name: \_\_\_\_\_ Exam Date: \_\_\_\_\_

Record the symbols "P" for passing or "F" for failing on each step of the checklist.

Procedure Element	Trial 1	Trial 2
1. Setup	_____	_____
2. Test Execution	_____	_____
3. Test Completion	_____	_____
4. Report	_____	_____

Comments: First Attempt: Pass \_\_\_\_\_ Fail \_\_\_\_\_ Second Attempt: Pass \_\_\_\_\_ Fail \_\_\_\_\_

Examiner Signature: \_\_\_\_\_ WAQTC #: \_\_\_\_\_





## WSDOT Test Method T 423

### ***Test Method for NEMA Type Traffic Controller Cabinet, 300 Series (Type 170/2070) Traffic Controller Cabinet, and Advanced Transportation Controller (ATC) Cabinet Conflict Monitor Testing***

#### 1. Scope

The purpose of this test method is to evaluate the operation of the Conflict Monitor Unit (CMU) which is supplied with each Traffic Controller Cabinet. This test method may also be used to test Conflict Monitor Units submitted for testing as piece parts upon request. To provide harmonization within this document, the nomenclatures “Conflict Monitor”, “Signal Conflict Monitor”, “Malfunction Management Unit”, “Monitor Unit”, and “Conflict Monitor Unit” used in the reference documents are synonyms and will be referred to in this document as “CMU”.

#### 2. Reference Documents

- WSDOT *Standard Specifications* 9-29.13
- AASHTO/ITE/NEMA Publication ATC 5301, Advanced Transportation Controller (ATC) Cabinet Standard
- Caltrans Transportation Electrical Equipment Specifications
- FHWA-IP-78-16, Type 170 Traffic Signal Controller System Hardware Specification
- NEMA Standards Publication TS-1, Traffic Control Systems
- NEMA Standards Publication TS-2, Traffic Controller Assemblies with NTCIP Requirements

#### 3. Safety

Voltages up to 135 V<sub>ac</sub> may be present on the test apparatus when energized. Caution should be exercised when operating the test apparatus. Only the interface of the CMU (buttons and switches) shall be touched while energized. Electro-Static Discharge (ESD) Wrist Straps Shall be removed prior to energizing circuits.

#### 4. Apparatus

An Electro-Static Discharge (ESD) Wrist Strap with cord and alligator clip shall be worn when handling de-energized Circuit Card Assemblies (CCA's) to prevent ESD damage. The Wrist Strap shall be connected via the cord to the Traffic Controller Cabinet chassis ground or the ESD mat in the testing area in order to maintain the card handler at the same electrical potential as chassis ground. The Wrist Strap shall be removed prior to energizing circuits.

Metalized, static shielding bag to protect the CMU from Electro-Static Discharge (ESD) while transporting it between the Traffic Controller Cabinet and the testing area.

Electro-Static Discharge (ESD) Mat connected to earth ground for queuing of the CMU to test.

Conflict Monitor Tester, or device capable of simulating supply voltage failures and conflicting field output circuit “ON” conditions.

## 5. Procedure

### 5.1 Removal and Test Apparatus Installation

**For CMU's supplied with a Traffic Controller Cabinet:** Ensure the Traffic Controller Cabinet is off prior to removing the CMU. Attach one end of the ESD Wrist Strap to a convenient wrist, and the other end to a convenient chassis ground point of the Traffic Controller Cabinet. Disconnect the Red Interface Cable if equipped. Disconnect any RS-232 or Ethernet cable connections from the front of the CMU, if equipped. Remove the CMU from the Traffic Controller Cabinet and place in a static shielding bag for transport to the test area. Disconnect the ESD Wrist Strap from the chassis ground point of the Traffic Controller Cabinet.

**For CMU's submitted for testing as piece parts:** Open packaging at the testing area. If the CMU is not in a static-shielding bag, place it in one at this time.

Proceed to move the CMU to the testing area if not already done. Connect one end of the ESD Wrist Strap to the ESD Mat of the testing area. Ensure the Conflict Monitor Tester is off. Connect the CMU to the Conflict Monitor Tester. Take off the ESD Wrist Strap and leave the other end connected to the ESD Mat.

### 5.2 Setup

Remove the vendor supplied Conflict Programming Card and replace it with a complete diode-equipped Lab Test Card. Power up the Conflict Monitor Tester and open the control program from the PC connected to the tester. Select the Conflict Monitor Unit type for the Unit Under Test (UUT). Select the manufacturer, model number, and enter the serial number for the UUT.

Select the correct test type and optional tests for the configuration of the CMU to be tested. Options vary from configuration to configuration and cannot be covered here. The only consistent option is the type of test to be run, which is "Certification" as we are certifying the CMU.

### 5.3 Test Execution

Once all identifying information has been entered, click on the appropriate control program button to start the test. Follow all prompts to test completion.

### 5.4 Test Completion

Upon successful completion of all tests, note the test results. If there are any deficiencies, print out the test report to refer to later. Close the control program and power down the Conflict Monitor Tester. Remove the Lab Test Card and re-install the vendor supplied Conflict Programming Card. Put on the ESD Wrist Strap, remove the CMU from the Conflict Monitor Tester, and place it in a static shielding bag. Return all test equipment to their proper storage location.

## 5.5 Re-Installation and Power-Up

**For CMU's supplied with a Traffic Controller Cabinet:** Transport the CMU from the testing area to the Traffic Controller Cabinet under test. Ensure the Traffic Controller Cabinet is off. Attach one end of the ESD Wrist Strap to a convenient wrist, and the other end to a convenient chassis ground point of the Traffic Controller Cabinet. Remove the CMU from the static shielding bag and re-install into the Traffic Controller Cabinet. Remove the ESD Wrist Strap from chassis ground and the wrist. Power up the Traffic Controller Cabinet and ensure that the CMU is functioning properly. Depending on the model, it may need a configuration reset.

**For CMU's submitted for testing as piece parts:** Properly package the CMU for shipment to its final destination.

## 6. Report

Record any deficiency that results in a "FAIL" on the test report in MATS. Verification tests shall be recorded in MATS as "As Received" if sufficient, and "As Shipped" if deficient but corrected. Verification tests that do not apply shall have neither option checked. The overall test results shall be recorded as a "Pass" or "Fail" for test T 423 in MATS.



# Performance Exam Checklist

## WSDOT Test Method T 423

**Test Method for NEMA Type Traffic Controller Cabinet, 300 Series (Type 170/2070) Traffic Controller Cabinet, and Advanced Transportation Controller (ATC) Cabinet Conflict Monitor Testing**

Participant Name: \_\_\_\_\_ Exam Date: \_\_\_\_\_

Record the symbols "P" for passing or "F" for failing on each step of the checklist.

Procedure Element	Trial 1	Trial 2
1. Removal and Test Apparatus Installation	_____	_____
2. Setup	_____	_____
3. Test Execution	_____	_____
4. Test Completion	_____	_____
5. Re-Installation and Power-Up	_____	_____
6. Report	_____	_____

Comments: First Attempt: Pass \_\_\_\_\_ Fail \_\_\_\_\_ Second Attempt: Pass \_\_\_\_\_ Fail \_\_\_\_\_

Examiner Signature: \_\_\_\_\_ WAQTC #: \_\_\_\_\_







## **WSDOT Test Method T 424**

### ***Test Method for NEMA Type Traffic Controller Cabinet and Advanced Transportation Controller (ATC) Cabinet Power Interruption Test***

#### **1. Scope**

The purpose of this test method is to evaluate Traffic Controller Cabinet operation when subjected to power interruptions of 450 milliseconds, and power interruptions greater than 500 milliseconds. This test shall be performed at nominal voltage and room temperature. This test only applies to NEMA Type Traffic Controller Cabinets and Advanced Transportation Controller (ATC) Cabinets.

#### **2. Reference Documents**

- AASHTO/ITE/NEMA Publication ATC 5301, Advanced Transportation Controller (ATC) Cabinet Standard
- NEMA Standards Publication TS-1, Traffic Control Systems
- NEMA Standards Publication TS-2, Traffic Controller Assemblies with NTCIP Requirements

#### **3. Safety**

No PPE is required to perform this test.

Observe proper electrical cord handling to reduce the risk of electrical shock.

#### **4. Apparatus**

Bermer Corporation model PLM-103P Power Interruption Simulator, or device capable of simulating power interruption with adjustable interruption intervals.

## 5. Procedure

### 5.1 Setup

Ensure the Power Interruption Simulator power switch is in the “OFF” position and the Traffic Controller Cabinet Main is in the “OFF” position. Connect the Power Interruption Simulator to a 120 V<sub>ac</sub>, 60 Hz power source (standard wall outlet). Connect the Traffic Controller Cabinet to the Power Interruption Simulator. Power up the Power Interruption Simulator and then the Traffic Controller Cabinet. Program the controller to cycle on minimum recall. Ensure the Traffic Controller Cabinet is operating normally.

### 5.2 Test Execution

Set the Power Interruption Simulator to interrupt power at 450 millisecond intervals. Observe operation of the Traffic Controller Cabinet. The Traffic Controller Cabinet shall continue normal operation as though no power interruption has occurred. Repeat this test three times, noting the results.

Set the power Interruption Simulator to interrupt power at an interval greater than 500 milliseconds. Observe operation of the Traffic Controller Cabinet. The Traffic Controller Cabinet shall revert to its startup sequence upon each restoration of power. Repeat this test three times, noting the results.

### 5.3 Test Completion

Restore normal power to the Traffic Controller Cabinet. Ensure normal operation resumes. Power down the Traffic Controller Cabinet, then the Power Interruption Simulator. Disconnect the Traffic Controller Cabinet from the Power Interruption Simulator. Disconnect the Power Interruption Simulator from the 120 V<sub>ac</sub>, 60 Hz power source (standard wall outlet). Return all test equipment to their proper storage location.

## 6. Report

During Test Execution the Traffic Controller Cabinet must conduct operation in accordance with the above conditions. Any deviation from these conditions is considered a fail.

Record any deficiency that does not meet the above minimum requirements. The overall test result shall be recorded as a “Pass” or “Fail” for test T424 in MATS.

## Performance Exam Checklist

### WSDOT Test Method T 424

#### *Test Method for NEMA Type Traffic Controller Cabinet and Advanced Transportation Controller (ATC) Cabinet Power Interruption Test*

Participant Name: \_\_\_\_\_ Exam Date: \_\_\_\_\_

Record the symbols "P" for passing or "F" for failing on each step of the checklist.

Procedure Element	Trial 1	Trial 2
1. Setup	_____	_____
2. Test Execution	_____	_____
3. Test Completion	_____	_____
4. Report	_____	_____

Comments: First Attempt: Pass \_\_\_\_\_ Fail \_\_\_\_\_ Second Attempt: Pass \_\_\_\_\_ Fail \_\_\_\_\_

Examiner Signature: \_\_\_\_\_ WAQTC #: \_\_\_\_\_





## WSDOT Test Method T 425

### *Test Method for NEMA Type Traffic Controller Cabinet, 300 Series (Type 170/2070) Traffic Controller Cabinet, and Advanced Transportation Controller (ATC) Cabinet Environmental Chamber Testing*

#### 1. Scope

The purpose of this test method is to evaluate Traffic Controller Cabinet operation at environmental extremes. The environmental extremes in this document are derived from the reference documents listed below. To maintain uniformity and efficiency, all environmental extremes and test conditions listed in this document shall take precedence over those listed in each reference document. This test method will subject the Traffic Controller Cabinet to environmental conditions ranging from -30°F (-34°C) with no humidity control to 165°F (74°C) with 18% humidity at line Voltages ranging from 95 V<sub>ac</sub> to 135 V<sub>ac</sub>.

#### 2. Reference Documents

- AASHTO/ITE/NEMA Publication ATC 5301, Advanced Transportation Controller (ATC) Cabinet Standard
- Caltrans Transportation Electrical Equipment Specifications
- FHWA-IP-78-16. Type 170 Traffic Signal Controller System Hardware Specification
- NEMA Standards Publication TS-1, Traffic Control Systems
- NEMA Standards Publication TS-2, Traffic Controller Assemblies with NTCIP Requirements

#### 3. Safety

The environmental chamber produces extreme environmental conditions. Exercise caution to prevent injury to personnel and damage to equipment. A Respirator Hood Assembly connected to a supply of breathable air, grade D shall be worn when working inside the chamber at extreme temperatures. Leather gloves shall be worn when handling surfaces inside the chamber at extreme temperatures. Slip-resistant footwear shall be worn inside the chamber at all times.

#### 4. Apparatus

A chamber in which the Unit Under Test (UUT) can be subjected to the environmental conditions specified in section 1 and provide safe access. A temperature recording device shall record the temperature inside the chamber during the test with an accuracy of  $\pm 3^{\circ}\text{F}$ . The air inside the chamber shall be circulated so that no more than a  $3^{\circ}\text{F}$  variance will occur. The chamber control shall maintain constant absolute humidity from 109°F (43°C) to 165°F (74°C).

Variable Voltage transformer capable of delivering 95 V<sub>ac</sub> to 135 V<sub>ac</sub> at a frequency of 60 Hz  $\pm 3\text{Hz}$ .

Digital Multi-Meter (DMM) capable of measuring Voltage with a minimum resolution of 1 Volt.

Resistance load device to simulate each traffic signal light the UUT shall be equipped to operate.

## 5. Procedure

### 5.1 Low-Temperature, Low-Voltage Test:

#### 5.1.1 Test Conditions:

- a) Environmental chamber door: closed
- b) Temperature: -30°F (-34°C)
- c) Voltage: 95 V<sub>ac</sub> (see below for exceptions)
- d) UUT door(s): open
- e) Humidity control: off

#### 5.1.2 Test Procedure:

- 5.1.2.1 Place UUT into environmental chamber. While at room temperature, adjust the variable Voltage transformer output to 95 V<sub>ac</sub> (100 V<sub>ac</sub> for ATC Cabinets, 102 V<sub>ac</sub> for UUTs equipped with both a 2070 Controller and a standard 2010ECL Conflict Monitor Unit). This Voltage shall be monitored with the DMM. Verify that the UUT is fully operational.
- 5.1.2.2 Set the UUT Controller to operate at minimum recall. Lower the environmental chamber temperature to -30°F (-34°C) at a rate not to exceed 30°F (18°C) per hour. The UUT shall be on during the temperature ramp-down.
- 5.1.2.3 Once the temperature has stabilized at -30°F (-34°C), verify the items listed in Table 1 to ensure proper operation.
- 5.1.2.4 Remove power from the UUT. The UUT shall soak at -30°F (-34°C) for a period of 3 hours.
- 5.1.2.5 Restore power to the UUT. Verify that the UUT initiates its start-up sequence and resumes cycling on minimum recall.
- 5.1.2.6 Verify the items listed in Table 1 to ensure proper operation.
- 5.1.2.7 Upon satisfactory completion of this test, proceed to the Low-Temperature, High-Voltage Test.

### 5.2 Low-Temperature, High-Voltage Test:

#### 5.2.1 Test Conditions:

- a) Environmental chamber door: closed
- b) Temperature: -30°F (-34°C)
- c) Voltage: 135 V<sub>ac</sub>
- d) UUT door(s): open
- e) Humidity control: off

### 5.2.2 Test Procedure:

- 5.2.2.1 While at -30°F (-34°C) with the humidity control off, adjust the variable Voltage transformer output to 135 V<sub>ac</sub>. This Voltage shall be monitored with the DMM.
- 5.2.2.2 Allow the UUT to cycle on minimum recall for a period of 1 hour.
- 5.2.2.3 After 1 hour, verify the items listed in Table 1 to ensure proper operation.
- 5.2.2.4 Upon satisfactory completion of this test, proceed to the High-Temperature, High-Voltage Test.

## 5.3 High-Temperature, High-Voltage Test:

### 5.3.1 Test Conditions:

- a) Environmental chamber door: closed
- b) Temperature: 165°F (74°C)
- c) Voltage: 135 V<sub>ac</sub>
- d) UUT door(s): open
- e) Humidity control: in accordance with Table 2

### 5.3.2 Test Procedure:

- 5.3.2.1 With the UUT cycling on minimum recall, raise the environmental chamber temperature to 165°F (74°C) at a rate not to exceed 30°F (18°C) per hour. The UUT shall be on during the temperature ramp-up.
- 5.3.2.2 Set the humidity controls not to exceed 95% relative humidity over the temperature range of 40°F (4°C) to 109°F (43°C). When the temperature reaches 109°F (43°C), readjust the humidity control to maintain constant humidity; 109°F (43°C) wet bulb which results in the relative humidities shown in Table 2.
- 5.3.2.3 Allow the UUT to soak at 165°F (74°C), constant humidity for a period of 10 hours.
- 5.3.2.4 After 10 hours, verify the items listed in Table 1 to ensure proper operation.
- 5.3.2.5 Upon satisfactory completion of this test, proceed to the High-Temperature, Low-Voltage Test.

## 5.4 High-Temperature, Low-Voltage Test:

### 5.4.1 Test Conditions:

- a) Environmental chamber door: closed
- b) Temperature: 165°F (74°C)
- c) Voltage: 95 V<sub>ac</sub> (see below for exceptions)
- d) UUT door(s): open
- e) Humidity control: in accordance with Table 2

#### 5.4.2 Test Procedure:

- 5.4.2.1 While at 165°F (74°C) with constant humidity, adjust the variable Voltage transformer output to 95 V<sub>ac</sub> (100 V<sub>ac</sub> for ATC Cabinets, 102 V<sub>ac</sub> for UUTs equipped with both a 2070 Controller and a standard 2010ECL Conflict Monitor Unit). This Voltage shall be monitored with the DMM.
- 5.4.2.2 Allow the UUT to cycle on minimum recall for a period of 1 hours.
- 5.4.2.3 After 1 hour, verify the items listed in Table 1 to ensure proper operation.
- 5.4.2.4 Upon satisfactory completion of this test, proceed to the Nominal-Temperature, Nominal-Voltage Test.

### 5.5 Nominal-Temperature, Nominal-Voltage Test:

#### 5.5.1 Test Conditions:

- a) Environmental chamber door: closed
- b) Temperature: 68°F (20°C)
- c) Voltage: 120 V<sub>ac</sub>
- d) UUT door(s): open
- e) Humidity control: off

#### 5.5.2 Test Procedure:

- 5.5.2.1 While at 165°F (74°C) with constant humidity, adjust the variable Voltage transformer output to 120 V<sub>ac</sub>. This Voltage shall be monitored with the DMM.
- 5.5.2.2 Lower the environmental chamber to 68°F (20°C) at a rate not to exceed 30°F (18°C) per hour. The UUT shall be on during the temperature ramp-down.
- 5.5.2.3 Allow the UUT to cycle on minimum recall for a period of 1 hour.
- 5.5.2.4 After 1 hour, verify the items listed in Table 1 to ensure proper operation.

## 6. Report

- 6.1 A failure shall be defined as any occurrence which results in other-than-normal operation of the UUT; refer to 6.2 for details. If a failure occurs, the UUT shall be repaired or components replaced by the vendor, and the test during which the failure occurred shall be restarted from the beginning.
- 6.2 The UUT is considered to have failed if any of the following occur:
  - a) If the UUT skips intervals or interval portions, places false calls, presents false indications, exhibits disruption of normal sequence, produces changes in timing, or
  - b) If the UUT fails to satisfy the requirements of any portion of section 5
- 6.3 An analysis of the failure shall be performed and corrective action taken before the UUT is retested in accordance with this document. The analysis must outline what action was taken to preclude additional failures during the tests.



- 6.4 Upon completion of the tests, the UUT shall be visually inspected. If material changes are observed which will adversely affect the life of the UUT, the cause and conditions shall be corrected before material acceptance.
- 6.5 Record and report all findings, corrective actions, and pass/fail results taken on the test report. Verification tests shall be recorded in MATS as “As Received” if sufficient, and “As Shipped” if deficient but corrected. Inspection tests that do not apply shall have neither option checked. The overall test result shall be recorded as a “Pass” or “Fail” for test T425 in MATS.

**Table 1 Functional Verification**

Item Number	Item Description
1	Verify the function of the intersection display panel switches (if equipped).
2	Verify the function of the police panel switches.
3	Verify the function of the stop-time switch (inside).
4	Verify the function of the auto/flash switch (inside).
5	Reserved for future use.
6	Verify the function of external logic (NEMA, if equipped).
7	Verify the function of the loop detection panel (if equipped).
8	Verify the function of the pre-emption pushbutton on the door (NEMA, if equipped).
9	Verify the function of the pre-emption switches on the phase selectors.
10	Verify the operation of the emergency indication light (if equipped).
11	Verify the CMU/MMU is functioning properly.

**Table 2 Wet-Bulb Dry-Bulb Relative Humidity at Barometric Pressure of 29.92 inHg (Sea Level)**

Dry Bulb		Relative Humidity, Percent (For Dynamic Testing)	Wet Bulb	
°F	°C		°F	°C
40	4.4	75	37	2.8
50	10.0	80	47	8.3
60	15.6	83	57	13.9
70	21.1	86	67	19.4
80	26.7	87	77	25.0
90	32.2	89	87	30.6
100	37.8	89	97	36.1
110	43.3	90	107	41.7
120	48.9	70	109	42.8
130	54.4	50	109	42.8
140	60.0	38	109	42.8
150	65.6	28	109	42.8
160	71.1	21	109	42.8
165	73.9	18	109	42.8

Figure 1 Environmental Test Profile

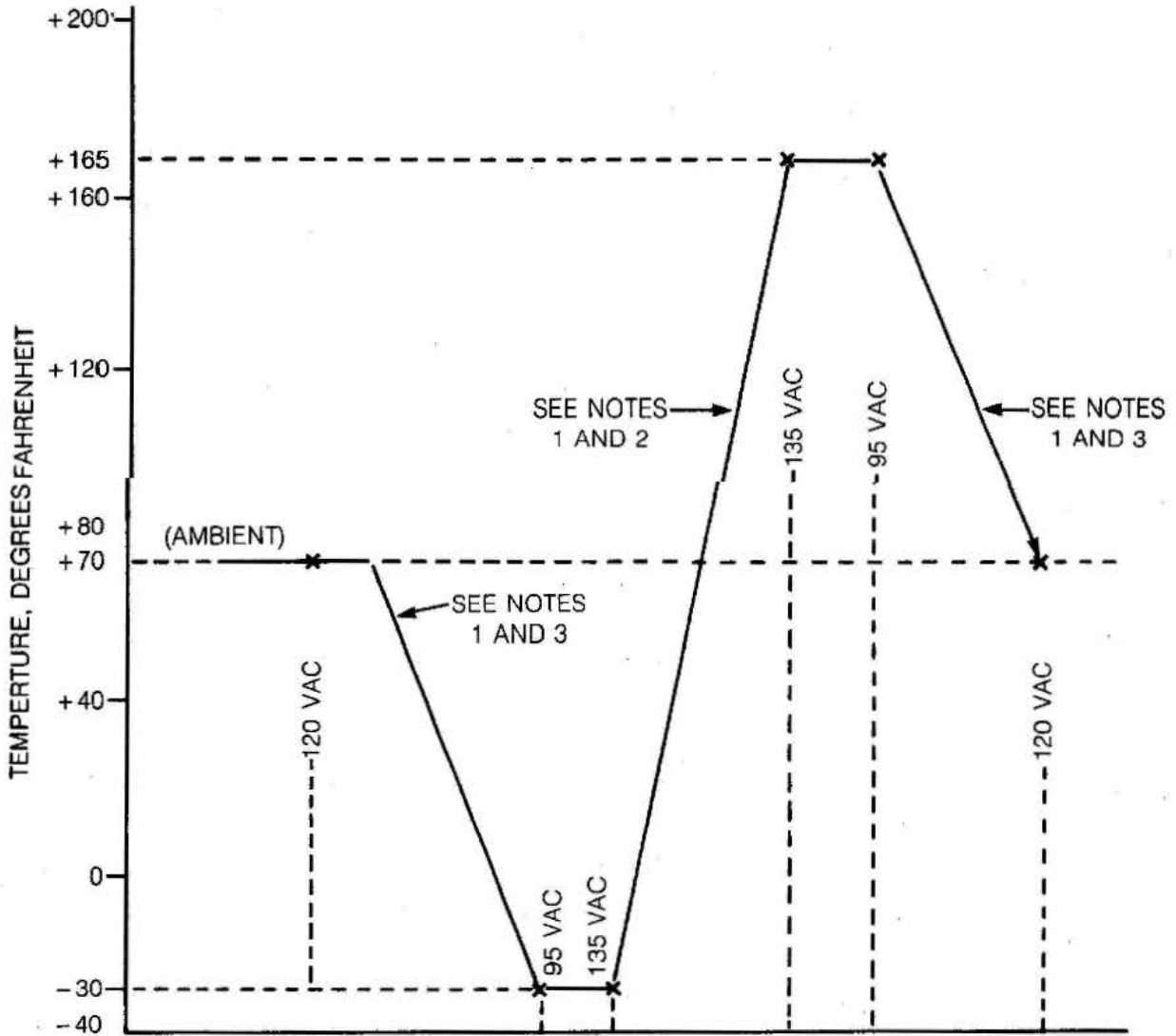

NOTE 1 – The rate of change in temperature shall not exceed 30°F (18°C) per hour.

NOTE 2 – Humidity controls shall be set in accordance with the humidities given in Table 2 during the temperature change between the Low-Temperature and High-Temperature tests.

NOTE 3 – If a change in both Voltage and temperature are required for the next test, the Voltage shall be selected prior to the temperature change.

# Performance Exam Checklist

## WSDOT Test Method T 425

**Test Method for NEMA Type Traffic Controller Cabinet, 300 Series (Type 170/2070) Traffic Controller Cabinet, and Advanced Transportation Controller (ATC) Cabinet Environmental Chamber Testing**

Participant Name: \_\_\_\_\_ Exam Date: \_\_\_\_\_

Record the symbols "P" for passing or "F" for failing on each step of the checklist.

Procedure Element	Trial 1	Trial 2
1. Test Setup – Place UUT into the Environmental Chamber	_____	_____
2. Low-Temperature, Low-Voltage Test	_____	_____
3. Low-Temperature, High-Voltage Test	_____	_____
4. High-Temperature, High-Voltage Test	_____	_____
5. High-Temperature, Low-Voltage Test	_____	_____
6. Nominal-Temperature, Nominal-Voltage Test	_____	_____
7. Report	_____	_____

Comments: First Attempt: Pass \_\_\_\_\_ Fail \_\_\_\_\_ Second Attempt: Pass \_\_\_\_\_ Fail \_\_\_\_\_

Examiner Signature: \_\_\_\_\_ WAQTC #: \_\_\_\_\_





## WSDOT Test Method T 426

### *Pull-Off Test for Hot Melt Traffic Button Adhesive*

#### 1. Scope

This method describes the procedure for determining the force (psi) required to pull a Type 1 raised pavement marker, from an asphalt or concrete surface that has been adhered with hot melt button adhesive.

#### 2. Apparatus and Materials

- a. Asphalt or concrete surface, conditioned for 24 hours at standard laboratory conditions prior to testing.
- b. Raised pavement marker – WSDOT Type 1 plastic or thermoplastic, drilled in the center to accept a threaded steel rod.
- c. Laboratory melter – as described in ASTM D5167.
- d. Threaded steel eye bolt for attaching to the raised pavement marker.
- e. Tensile testing apparatus – as described in AASHTO T 237 Section 15, fitted with a threaded steel rod with a 2 hook.

#### 3. Procedure

- a. Pull-off tests shall be run in triplicate.
- b. Hot melt traffic button adhesive shall be heated in a laboratory melter to the manufacturer's recommended application temperature.
- c. A quantity of adhesive sufficient to squeeze out a small bead around the entire periphery of a 4 button shall be poured onto surface and a pre-drilled raised pavement marker shall be seated on the adhesive and allowed to cure for at least 4 hours.
- d. A threaded steel eye bolt shall be inserted into the pre-drilled hole in the button.
- e. The puck/block and button shall be placed in the tensile testing apparatus and the threaded hook shall be inserted in the eye bolt.
- f. Load shall be applied slowly until the button pulls off from the surface and the maximum load shall be recorded.

#### 4. Calculation

The pull-off strength shall be calculated as follows:

$$\text{Pull-off Strength, psi} = L/A$$

L = Maximum load, pounds

A = Surface area of Pavement marker (in<sup>2</sup>)

#### 5. Report

The pull-off strength reported shall be the average of the three determinations.





## WSDOT Test Method T 427

### *Test Method for NEMA Type Traffic Controller Cabinet, 300 Series (Type 170/2070) Traffic Controller Cabinet, and Advanced Transportation Controller (ATC) Cabinet Loop Amplifier Testing*

#### 1. Scope

The purpose of this test method is to evaluate the operation of individual Loop Amplifiers which are supplied with each Traffic Controller Cabinet. This test method may also be used to test Loop Amplifiers submitted for testing as piece parts upon request.

#### 2. Reference Documents

- AASHTO/ITE/NEMA Publication ATC 5301, Advanced Transportation Controller (ATC) Cabinet Standard
- Caltrans Transportation Electrical Equipment Specifications
- FHWA-IP-78-16, Type 170 Traffic Signal Controller System Hardware Specification
- NEMA Standards Publication TS-1, Traffic Control Systems
- NEMA Standards Publication TS-2, Traffic Controller Assemblies with NTCIP Requirements

#### 3. Safety

Voltages up to 135 V<sub>ac</sub> may be present on the test apparatus when energized. Caution should be exercised when operating the test apparatus. Only the interface of a Loop Amplifier (buttons and switches) and the interface of the test apparatus (buttons and switches) shall be touched while energized. Electro-Static Discharge (ESD) Wrist Straps shall be removed prior to energizing circuits.

#### 4. Apparatus

An Electro-Static Discharge (ESD) Wrist Strap with cord and alligator clip shall be worn when handling Circuit Card Assemblies (CCA's) to prevent ESD damage. The Wrist Strap shall be connected via the cord to the Traffic Controller Cabinet chassis ground or the ESD mat in the testing area in order to maintain the card handler at the same electrical potential as chassis ground. The Wrist Strap shall be removed prior to energizing circuits.

Metalized, static-shielding bag to protect each Loop Amplifier from Electro-Static Discharge (ESD) while transporting between the Traffic Controller Cabinet and the testing area.

Electro-Static Discharge (ESD) mat connected to earth ground for queuing of Loop Amplifiers to test.

ATSI Loop Amplifier Tester model QC-330, or device capable of supplying operating power to the Loop Amplifier Unit-Under-Test (UUT) and capable of simulating Class 1, Class 2, and Class 3 vehicle calls (0.12μH, 0.3μH, and 3.0μH inductance signals, respectively, supplied to the UUT).

## 5. Procedure

### 5.1 Removal and Setup

**For Loop Amplifiers supplied with a Traffic Controller Cabinet:** Ensure that the Traffic Controller Cabinet is off prior to removing Loop Amplifiers. Attach one end of the ESD Wrist Strap to a convenient wrist, and the other end to a convenient chassis ground point of the Traffic Controller Cabinet. Remove each Loop Amplifier and place each in a separate static-shielding bag for transport to the testing area. Once all Loop Amplifiers have been removed, disconnect the ESD Wrist Strap from the chassis ground point of the Traffic Controller Cabinet.

**For Loop Amplifiers submitted for testing as piece parts:** Open packaging at the testing area. If any Loop Amplifiers are not in a static-shielding bag, place them in one at this time.

**For all Loop Amplifiers:** Proceed to move all Loop Amplifiers to the testing area if not already done. Connect one end of the ESD Wrist Strap to the ESD mat of the testing area. Remove each Loop Amplifier from its static-shielding bag and place on the ESD mat to prevent ESD damage while in queue for test.

Ensure the Loop Amplifier Tester is off. Connect a Loop Amplifier to the Tester. Remove the ESD Wrist Strap and leave the other end connected to the ESD mat. Power up the Loop Amplifier Tester.

### 5.2 Initial Condition

If the UUT is so-equipped, ensure that Delay timing, Extension timing, and all other options are off. Ensure that the Loop Amplifier is set to Presence mode, not Pulse mode. Repeat this process for each channel with which the UUT is equipped.

### 5.3 Sensitivity Adjustment

Set the sensitivity of each channel to minimum. Press the “Class 1” button for Channel 1 and note the duration of the “Call” indication. Increment the sensitivity for Channel 1 until the “Call” indication lasts more than two seconds. Repeat this process for each channel with which the UUT is equipped.

### 5.4 Pulse Mode Test

Set Channel 1 to Pulse mode. Press and hold the “Class 1” button for Channel 1. The “Call” indication should come on briefly to verify a Pulse condition. Wait three seconds. While still holding the “Class 1” button, press the “Class 2” button. A second “Call” indication should come on briefly to verify a second vehicle Pulse condition. If not, this test fails. Release the buttons and set Channel 1 back to Presence mode. Repeat this process for each channel with which the UUT is equipped.

### 5.5 Delay Timing Test

Set Channel 1 Delay timing to three seconds. Press and hold the “Class 1” button for Channel 1. The “Call” indication should blink for three seconds, then become steady on. If not, this test fails. Release the button and set Channel 1 Delay timing back to zero. Repeat this process for each channel with which the UUT is equipped.



## 5.6 Extension Timing Test

Set Channel 1 Extension timing to three seconds. Press and release the “Class 1” button for Channel 1. The “Call” indication should be steady on for three seconds, then off. Press and release the button again, wait two seconds, then press and release again. The “Call” indication should be steady on for a total of five seconds, then off. If not, this test fails. Set the Channel 1 Extension timing back to zero. Repeat this process for each channel with which the UUT is equipped.

## 5.7 Sustained Presence and Sustained Presence Recovery Test

Press and hold the “Class 3” button for Channel 1. Hold the button for at least ten seconds. The “Call” indication should be steady on for the duration of this action. Release the button for one second, then press it again. The “Call” indication should turn off for a moment, then turn back on indicating a new “Call”. Release the button and the “Call” indication should turn off. If not, this test fails. If this test fails, return to section 5.3 to readjust the sensitivity and retry this test. If this test fails after three sensitivity adjustments, the UUT is considered faulty. Repeat this process for each channel with which the UUT is equipped.

## 5.8 Test Completion

Upon successful completion of all tests on all channels, power down the Loop Amplifier Tester. Attach the ESD Wrist Strap to one wrist, remove the Loop Amplifier from the tester, and place it in a static-shielding bag. Repeat this process for each Loop Amplifier submitted for testing. Return all test equipment to their proper storage location.

## 5.9 Re-Installation and Power-Up

**For Loop Amplifiers supplied with a Traffic Controller Cabinet:** Transport all Loop Amplifiers from the testing area to the Traffic Controller Cabinet under test. Ensure the Traffic Controller Cabinet is off. Attach one end of the ESD Wrist Strap to a convenient wrist, and the other end to a convenient chassis ground point of the Traffic Controller Cabinet. Remove each Loop Amplifier from its separate static shielding bag and re-install into the Traffic Controller Cabinet. Once all Loop Amplifiers are re-installed, remove the ESD Wrist Strap from chassis ground and the wrist. Power up the Traffic Controller Cabinet and ensure that all Loop Amplifiers are functioning.

**For Loop Amplifiers submitted for testing as piece parts:** Properly package the Loop Amplifiers for shipment to their final destination.

## 6. Report

Record any deficiency that does not meet the above minimum requirements. Verification tests shall be recorded in MATS as “As Received” if sufficient, and “As Shipped” if deficient but corrected. Verification tests that do not apply shall have neither option checked. The overall test result shall be recorded as a “Pass” or “Fail” for test T427 in MATS.



# Performance Exam Checklist

## WSDOT Test Method T 427

**Test Method for NEMA Type Traffic Controller Cabinet, 300 Series (Type 170/2070) Traffic Controller Cabinet, and Advanced Transportation Controller (ATC) Cabinet Loop Amplifier Testing**

Participant Name: \_\_\_\_\_ Exam Date: \_\_\_\_\_

Record the symbols "P" for passing or "F" for failing on each step of the checklist.

Procedure Element	Trial 1	Trial 2
1. Removal and Setup	_____	_____
2. Initial Condition	_____	_____
3. Sensitivity Adjustment	_____	_____
4. Pulse Mode Test	_____	_____
5. Delay Timing Test	_____	_____
6. Extension Timing Test	_____	_____
7. Sustained Presence and Sustained Presence Recovery Test	_____	_____
8. Test Completion	_____	_____
9. Re-Installation and Power-Up	_____	_____
10. Report	_____	_____

Comments: First Attempt: Pass \_\_\_\_\_ Fail \_\_\_\_\_ Second Attempt: Pass \_\_\_\_\_ Fail \_\_\_\_\_

Examiner Signature: \_\_\_\_\_ WAQTC #: \_\_\_\_\_



## **WSDOT Test Method T 428**

### ***Test Method for Traffic Controller Compliance Inspection and Test Procedure***

#### **1. Scope**

The purpose of this procedure is to provide a documented method for the steps involved with the inspection and testing of the completed Traffic Controller Cabinets.

#### **2. Reference Documents**

- WSDOT *Standard Specifications* 9-29.13
- WSDOT Test Method T 421, Traffic Controller Cabinet Inspection Procedure
- WSDOT Test Method T 422, Transient Voltage Test (Spike Test) Procedure (optional)
- WSDOT Test Method T 423, Conflict Monitor Test Procedure
- WSDOT Test Method T 424, Power Interruption Test Procedure
- WSDOT Test Method T 425, Environmental Chamber Test Procedure
- WSDOT Test Method T 427, Loop Amplifier Test Procedure

#### **3. Safety**

Utilize PPE and observe safety practices as defined in WSDOT Test Methods T 421, T 422, T 423, T 424, T 425, and T 427.

#### **4. Apparatus**

Utilize equipment as defined in WSDOT Test Methods T421, T422, T423, T424, T425, and T427.

Combination resistor/LED load bank to simulate each traffic signal light in operation.

EDI Model SM662 Isolator Test Cards to test field termination wiring.

Field termination test probe consisting of two 1N4148 diodes wired in parallel.

Opticom strobe system tester to test pre-emption devices.

Suitable jumper to test pedestrian field terminals.

#### **5. Procedure**

- 5.1 Perform Traffic Controller Cabinet Inspection Procedure in accordance with WSDOT Test Method T 421.
- 5.2 Perform Environmental Chamber Test Procedure in accordance with WSDOT Test Method T 425.
- 5.3 If required by Contract Documents or otherwise requested, perform Transient Voltage Test (Spike Test) Procedure in accordance with WSDOT Test Method T 422.
- 5.4 Perform Conflict Monitor Test Procedure in accordance with WSDOT Test Method T 423.

- 5.5 If equipped, perform Loop Amplifier Test Procedure in accordance with WSDOT Test Method T 427.
- 5.6 If applicable, perform Power Interruption Test Procedure in accordance with WSDOT Test Method T 424.
- 5.7 Verify the GFCI is operational.
- 5.8 Verify the vent fan(s) is(are) operational.
- 5.9 Verify the cabinet door light switch(es) is(are) operational.
- 5.10 Verify the correct operation of the master controller, if so equipped.
  - 5.11.1 Verify the correct operation of vehicle test switches, if so equipped.
  - 5.11.2 Verify the correct operation of pedestrian test switches, if so equipped.
  - 5.12.1 Verify the correct operation of vehicle (loop sensor) field terminals. This will require the use of EDI Model SM662 Isolator Test Cards and a field termination probe.
  - 5.12.2 Verify the correct operation of pedestrian field terminals. This will require the use of a suitable jumper.
  - 5.13.1 Verify the correct operation of pre-emption (phase selector) cards, if so equipped.
  - 5.13.2 Verify the correct operation of pre-emption (phase selector) test switches, if so equipped.
  - 5.13.3 Verify the correct operation of pre-emption (phase selector) field terminals, if so equipped. This will require the use of an Opticom strobe system tester.
- 5.14 Verify the correct operation of railroad pre-emption cards, if so equipped.
- 5.15 Verify the correct operation of the internal "auto/flash" switch.
- 5.16 Verify the correct operation of the internal "stop time" switch.
- 5.17 Verify the correct operation of the external police panel switch(es).
- 5.18 Set up cabinet to run on minimum recall with a combination resistor/LED load bank. Run a performance test for a period of no less than 72 hours.

## 6. Report

Record any deficiency that does not meet the above minimum requirements. Report any corrective actions taken on the test report. The overall test result shall be recorded as a "Pass" or "Fail" for test T 428 in MATS.

# Performance Exam Checklist

## WSDOT Test Method T 428

### Test Method for Traffic Controller Compliance Inspection and Test Procedure

Participant Name: \_\_\_\_\_ Exam Date: \_\_\_\_\_

Record the symbols "P" for passing or "F" for failing on each step of the checklist.

Procedure Element	Trial 1	Trial 2
1. Perform Traffic Controller Cabinet Inspection T421	_____	_____
2. Perform Environmental Chamber Test T425	_____	_____
3. If required or requested, perform Transient Voltage Test T422	_____	_____
4. Perform Conflict Monitor Test T423	_____	_____
5. Perform Loop Amplifier Test T427	_____	_____
6. Perform Power Interruption Test T424	_____	_____
7. Perform T428 Specific Compliance Inspection and Tests	_____	_____
8. Report	_____	_____

Comments: First Attempt: Pass \_\_\_\_\_ Fail \_\_\_\_\_ Second Attempt: Pass \_\_\_\_\_ Fail \_\_\_\_\_

Examiner Signature: \_\_\_\_\_ WAQTC #: \_\_\_\_\_







## WSDOT SOP 429

### *Methods for Determining the Acceptance of Traffic Signal Controller Assemblies*

#### 1. Scope

The purpose of this procedure is to provide a documented method for the steps involved with inspection and testing of the completed traffic controller cabinets.

#### 2. Reference Documents

- WSDOT *Standard Specifications 9-29.13*
- WSDOT Test Method T428, Traffic Controller Compliance Inspection and Test Procedure
- WSDOT Test Method T421, Traffic Controller Cabinet Inspection Procedure
- WSDOT Test Method T425, Environmental Chamber Test Procedure
- WSDOT Test Method T422, Transient Voltage Test (Spike Test) Procedure (optional)
- WSDOT Test Method T423, Conflict Monitor Test Procedure
- WSDOT Test Method T427, Loop Amplifier Test Procedure
- WSDOT Test Method T424, Power Interruption Test Procedure

#### 3. Process

WSDOT Test Method T428 Traffic Controller Compliance Inspection and Test Procedure

When the Traffic Controller Cabinet assembly arrives for testing, the Contractor Representative (typically the Vendor) should have an appointment scheduled. Within seven (7) calendar days of arrival, the Contractor Representative shall assemble and demonstrate the Traffic Controller Cabinet assembly. Test Method T428 is the root test procedure for complete testing of Traffic Controller Cabinet assemblies. T428 provides the sequence in which testing shall be completed for a Traffic Controller Cabinet assembly unless otherwise specified in the Contract Document(s) and/or Special Provision(s), or as scheduling demands allow. All other test methods in this document are a subset of T428, and are outlined below.

**WSDOT Test Method T421 Traffic Controller Cabinet Inspection Procedure**

Test Method T421 shall be completed in the presence of the Contractor Representative (typically the Vendor). After acceptance for testing, a letter or an e-mail is to be sent to the Project Engineer and/or the local agency identifying the assembly as ready for testing. If the assembly of the Traffic Controller Cabinet and acceptance for testing is not complete within seven (7) calendar days of delivery, disposition of the Traffic Controller Cabinet is at the discretion of the Electrical Materials Laboratory personnel. The Electrical Materials Laboratory personnel may authorize the return of the assembly to the Contractor, with collect freight charges to the Contractor. This test method may also be performed standalone, if requested by a Project Office.

**WSDOT Test Method T425 Environmental Chamber Test Procedure**

Immediately after completion of T421, the Traffic Controller Cabinet assembly shall undergo Environmental Testing as described as T425. This test method will determine the ability of the Traffic Controller Cabinet assembly to withstand various environmental and line input conditions as outlined in Caltrans TEES (Transportation Electrical Equipment Specifications), FHWA-IP-78-16 (Federal Highway Administration Type 170 Signal Controller System Hardware Specification), AASHTO/ITE/NEMA ATC 5301 (Advanced Transportation Controller Cabinet Standard), NEMA TS-1 (Traffic Control Systems), and NEMA TS-2 (Traffic Controller Assemblies with NTCIP Requirements). This test method may also be performed standalone, if requested by a Project Office.

**WSDOT Test Method T422 Transient Voltage Test (Spike Test) Procedure (optional)**

T422 is an optional test, and is only to be performed on random samples or if specified in the Contract Document(s) or Special Provision(s). This test will determine the ability of the Traffic Controller Cabinet assembly to withstand transient line input Voltages. T422 shall only be performed on NEMA Type Traffic Controller Cabinet assemblies and 300 Series (Type 170/2070) Traffic Controller Cabinet assemblies. This test method may also be performed standalone, if requested by a Project Office.

**WSDOT Test Method T423 Conflict Monitor Test Procedure**

T423 will evaluate the operation of the Conflict Monitor Unit (CMU), also known as a Malfunction Management Unit (MMU). This test method may also be performed standalone, if requested by a Project Office.

**WSDOT Test Method T427 Loop Amplifier Test Procedure**

T427 will evaluate the operation of the individual Loop Amplifiers which are supplied with each Traffic Controller Cabinet assembly. If a Traffic Controller Cabinet assembly is not equipped with any Loop Amplifiers (i.e., when configured for video or radar detection), this test method may be skipped. This test method may also be performed standalone, if requested by a Project Office.

---

**WSDOT Test Method T424 Power Interruption Test Procedure**

T424 will evaluate the operation of the Traffic Controller Cabinet assembly when subjected to power interruptions of 450 milliseconds, and power interruptions greater than 500 milliseconds. This test only applies to NEMA Type Traffic Controller Cabinet assemblies and Advanced Transportation Controller (ATC) Cabinet assemblies, and shall be skipped on 300 series (Type 170/2070) Traffic Controller Cabinet assemblies. This test method may also be performed standalone, if requested by a project office.

Upon completion of all testing, the test report shall be archived in MATS for any interested parties to obtain. If there are three (3) or more failures after the Traffic Controller Cabinet assembly has passed T421 and T425, the Traffic Controller Cabinet assembly shall be rejected. Otherwise, the Contractor Representative (typically the Vendor) may address the deficiencies and the process may be re-started at the beginning of the failed test, or at the beginning of the highest level failed test.

Upon successful completion of all tests, custody of the Traffic Controller Cabinet assembly shall be transferred to the designated Regional Signal Shop for further testing if specified in the Contract Document(s) or Special Provision(s), or if specified by the Project Office. Otherwise, custody of the Traffic Controller Cabinet assembly shall be transferred to the Contractor.

# WSDOT SOP 429 PROCESS FLOWCHART

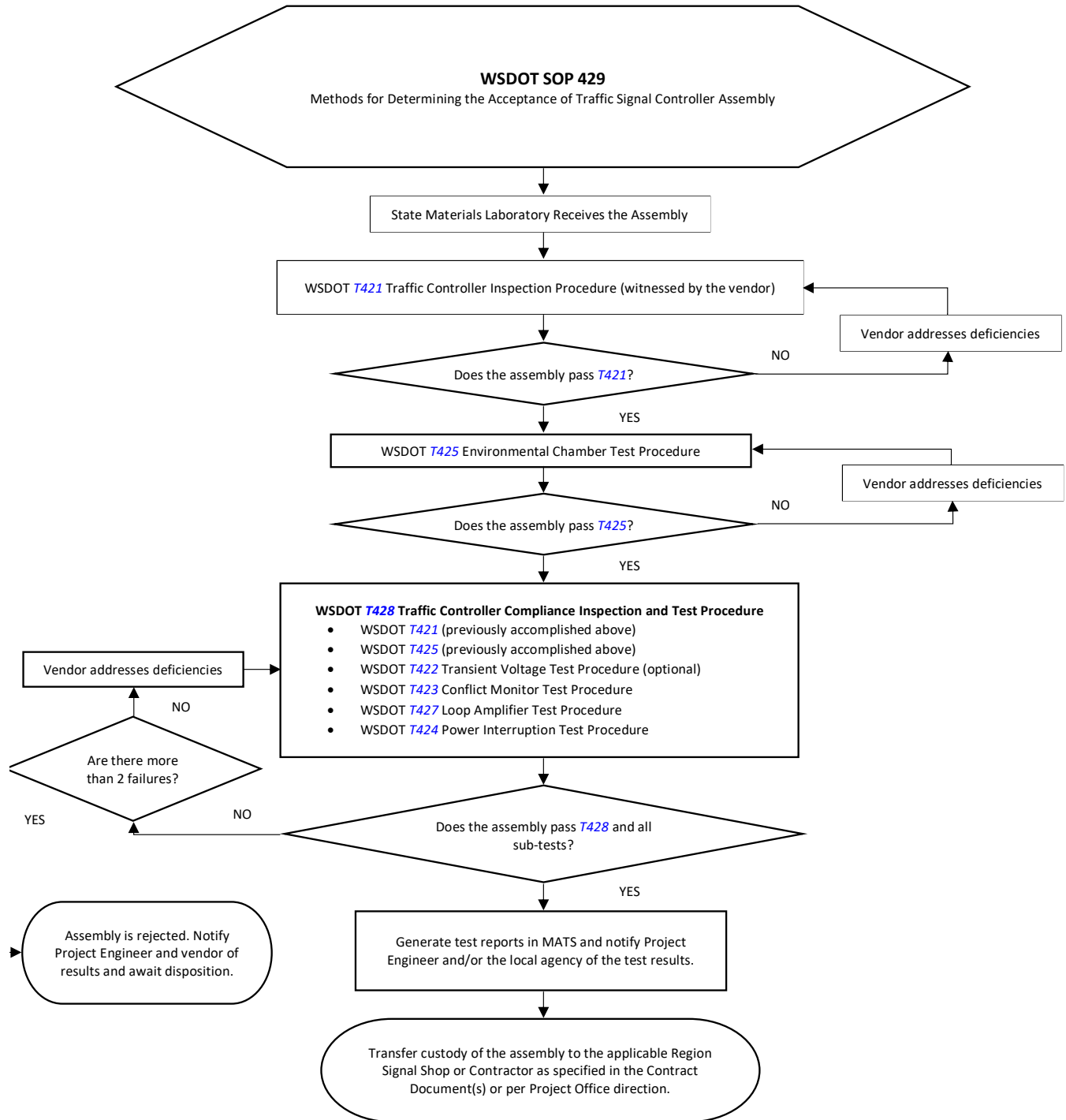



## WSDOT Test Method T 430

### *Test Method for Uninterruptible Power Supply (UPS) System Compliance Inspection and Test Procedure*

#### 1. Scope

The purpose of this test method is to provide a documented method for the steps involved with the inspection and testing of an Uninterruptible Power Supply (UPS) system.

#### 2. Reference Documents

- WSDOT *General Special Provisions* 8-20.2(9-29.13).OPT1.GR8
- WSDOT *General Special Provisions* 8-20.3(14).OPT1.GR8
- NEMA Standards Publication PE-1, Uninterruptible Power Systems (UPS) – Specification and Performance Verification
- IEC Standards Publication 62040-3: Uninterruptible Power Systems (UPS) – Method of specifying the performance and test requirements
- IEEE Standards Publication 1188 – Recommended Practice for Maintenance, Testing, and Replacement of Valve-Regulated Lead-Acid (VRLA) batteries for Stationary Applications

#### 3. Safety

Use proper lifting techniques whenever handling equipment, parts, or batteries.

Always assume electrical connections or conductors are live. Exercise caution when working with electrical connections as high voltages could be present. Wear insulating gloves and use insulated tools when working with any electrical connections.

Batteries should be handled with extreme care as they can cause severe injury. Spilled electrolyte can destroy clothing, burn skin, or cause blindness. Always wear eye protection and wear rubber gloves when working with batteries.

#### 4. Apparatus

DATAQ Instruments model DI-718B Data Logger or device capable of simultaneously logging ac load Voltage, UPS Battery set dc input current, UPS Battery set dc input Voltage, and UPS Battery set temperature.

Simpson model 06713 current shunt or device capable of providing a current measurement range up to 100 Amperes through a 50 millivolt conversion drop.

DATAQ Instruments WinDAQ software or software capable of accessing and processing playback of logged data from the data logger. Through linear interpolation, this data will be used to produce a test report detailing calculated operational duration and power efficiencies based on different load values.

Passive load designed to operate on 120 V<sub>ac</sub>. Power rating shall vary based on Contract Documents.

#### 5. Procedure

##### 5.1 Incoming Inspection

When the Uninterruptible Power Supply (UPS) Cabinet arrives for testing, the contractor representative (typically the contractor's vendor) should have an appointment scheduled. Within seven (7) calendar days of arrival, the contractor representative shall assemble and demonstrate the Uninterruptible Power Supply (UPS) Cabinet. If assembly is not completed within these seven (7) calendar days, disposition of the Uninterruptible Power Supply (UPS) Cabinet is at the discretion of the Electrical Materials Laboratory personnel. Inspect the Uninterruptible Power Supply (UPS) Cabinet, battery set, and any accessories for damage during shipping. Note any deficiencies.

##### 5.2 Notify Project Office

Notify the project office and the contractor of the receipt of the Uninterruptible Power Supply (UPS) system. Note all Points-of-Contact who shall be copied on all communications and test results for this project

##### 5.3 Assess Uninterruptible Power Supply (UPS) System Compliance

The Uninterruptible Power Supply (UPS) System shall be inspected to ensure that it is in compliance with General Special Provisions and Contract Documents. Ensure that all of the required equipment is installed per these General Special Provisions and Contract Documents. In the event of a conflict, Contract Documents take precedence over the General Special Provisions. At a minimum, the following items shall be inspected against the Contract Documents and General Special Provisions:

1. Cabinet Construction (cabinet type, door lock type, lighting type, etc.)
2. System Components (controller type, battery type, accessories, etc.)
3. System Documentation (serial numbers, drawings, component manuals, etc.)

## 5.4 Assess Uninterruptible Power Supply (UPS) System Performance

### 5.4.1 Setup

The contractor representative shall provide all work necessary to assemble the UPS system at the State Materials Laboratory. Upon delivery, the battery set shall be installed and the UPS system shall be made fully operational by the contractor representative.

Two sets of data will be recorded for the duration of this test, one manually recorded and one automatically recorded via Data Logger. Once the UPS system is fully operational, the Data Logger shall be installed to monitor operation while under load. The following parameters shall be monitored: ac load Voltage, UPS battery set dc current, UPS battery set dc Voltage, and UPS battery set temperature. Power down the UPS system. Connect the ac load Voltage monitor in parallel with the ac test load. Do not connect the ac test load to the UPS cabinet at this time. Install a current shunt in series with the negative line of the UPS battery set. Connect the UPS battery set dc current monitor across the series current shunt between the UPS battery set and the UPS cabinet. Connect the UPS dc Voltage monitor across the UPS battery set terminals. Finally, connect the UPS battery set temperature monitor to the case of the upstream-most UPS battery. Power up the UPS system.

Manually recording of data shall be performed at regular intervals during this test. This data will be taken from the UPS system Inverter Display. The following items are to be recorded:

- VIN (line Voltage in to the Inverter in  $V_{rms}$ )
- VOUT (output Voltage from the inverter to the test load in  $V_{rms}$ )
- IOUT AC (output current from the Inverter to the test load in  $A_{ac}$ )
- BATT TEMP (battery temperature in degrees Celsius)
- FREQ IN (line frequency in to the Inverter in Hertz)
- OUTPUT PWR (output power from the Inverter to the test load in Watts)
- BATT VOLT (battery Voltage to the Inverter in  $V_{dc}$ )
- CHGR CUR (battery charging current in  $A_{dc}$ )
- kWh (accumulated output energy in kilo-Watthours)
- Remain Tm (remaining battery runtime in hours and minutes)

### 5.4.2 Test Execution

Allow the UPS cabinet to fully charge the UPS battery set prior to test. The UPS battery set is considered fully charged when the charging current is less than 500 milliAmperes and the battery set Voltage is  $53.5 \pm 0.5 V_{dc}$ .

Verify the UPS system is not connected to a load, that it is connected to both line input and the UPS battery set, and the system is operational. The system is now at its initial condition. Start the Data Logger for automatically recorded data and take note of the first set of Inverter Display readings for manually recorded data.

Connect the test load to the UPS system and verify the load is operating. The size of the test load shall be specified in the Contract Documents. With the test load connected, disconnect the line input to the UPS system. The UPS system shall switch from line input operation to battery operation with no interruption of power to the test load. The system is now at its test condition. Take note of the next set of Inverter Display readings for manually recorded data. Continue to manually record Inverter Display readings at regular intervals until the UPS system powers down (this occurs when battery Voltage reaches  $42.0 \pm 0.5 V_{dc}$ ).

### 5.4.3 Test Completion

After the UPS system powers down, stop the Data Logger and disconnect the test load. Disconnect all Data Logger monitors from the UPS system. Reconnect the line input to the system and allow the UPS battery set to fully charge. Note the time required for the UPS battery set to fully charge.

After the UPS battery set is fully charged, remove all laboratory equipment and prepare the UPS system for shipment. Return all test equipment to their proper storage location.

## 6. Report

Compile the manually recorded data into a spreadsheet for evaluation. Use the Data Logger software to compile automatically recorded data into plots for each of the channels monitored. Using linear interpolation, calculate the operational duration and power efficiencies for different load values. The data recorded between the two methods should reasonably align with each other.

Inspect the plots detailing the ac load Voltage (Output Voltage), UPS battery set dc current (Batteries Current), UPS battery set dc Voltage (Batteries Voltage), and UPS battery set temperature (Batteries Temperature). There shall be no spikes or drops (glitches) observed in the plots throughout the duration of the test. The plot values shall be within the battery manufacturer's recommended values in order for the test to be considered successful. The operational duration (Battery Life) shall be within the battery manufacturer's recommended values in order for the test to be considered successful.

Record any deficiency that does not meet the above minimum requirements. Report any corrective actions taken on the test report. The overall test result shall be recorded as a "Pass" or "Fail" for test T 430 in MATS.



# Performance Exam Checklist

## Method T 430 Checklist

### *Test Method for Uninterruptible Power Supply (UPS) System Compliance Inspection and Test Procedure*

Participant Name: \_\_\_\_\_ Exam Date: \_\_\_\_\_

Record the symbols "P" for passing or "F" for failing on each step of the checklist.

Procedure Element	Trial 1	Trial 2
1. Setup	_____	_____
2. Test Execution	_____	_____
3. Test Completion	_____	_____
4. Report	_____	_____

Comments: First Attempt: Pass \_\_\_\_\_ Fail \_\_\_\_\_ Second Attempt: Pass \_\_\_\_\_ Fail \_\_\_\_\_

Examiner Signature: \_\_\_\_\_ WAQTC #: \_\_\_\_\_





## WSDOT Test Method T 432

### *Flexibility Test for Hot-Melt Adhesives*

#### 1. Scope

This method describes the determination of flexibility of hot-melt adhesives under specific conditions.

#### 2. Referenced Documents

- a. WSDOT SOP 318 – Standard Operating Procedure for Melting of Bituminous Pavement Marker Adhesive.
- b. ASTM D3111 – Standard Test Method for Flexibility of Hot-Melt Adhesives by Mandrel Bend Test Method – modified to meet WSDOT specification.

#### 3. Apparatus and Materials

- a. 1 diameter Mandrel and holder.
- b. Three-specimen stainless steel flexibility mold, 1/8 x 1 x 6 dimensions.

#### 4. Procedure

- a. Adhesive material is melted and prepared by Liquid Asphalt lab per WSDOT SOP 318.
- b. Test specimens poured into the flexibility mold.
- c. Test specimens allowed to cure at room temperature for at least one hour.
- d. The test specimens removed from the mold and conditioned at 20°F for minimum of four hours.
- e. The 1 diameter Mandrel and its holder are also conditioned at 20°F for minimum of four hours.
- f. Flexibility test is done in the same environment used to condition the specimens, by bending each specimen over the 1 Mandrel in an arc of 90° at a uniform rate for ten seconds.

#### 5. Report

Flexibility shall be reported as Pass/Fail. Failure is a visible fracture, crazing, or cracking of the hot-melt adhesive that can occur at any time during the bending of two out of the three specimens.





## WSDOT Test Method T 501

### *Test Method to Determine Durability of Very Weak Rock*

#### 1. Scope

- 1.1 This test method covers the determination of the Jar Slake Index,  $I_j$ , of weak rock.
- 1.2 The values stated in SI units are regarded as the standard.
- 1.3 This standard does not purport to address all of the safety concerns, if any, associated with its use. It is the responsibility of the user of this standard to establish appropriate safety and health practices and determine the applicability of regulatory limitations prior to use.

#### 2. Referenced Documents

- 2.1 ASTM Standards
  - D 653 Terminology Relating to Soil, Rock, and Contained Fluids
  - D 2113 Practice for Rock Core Drilling and Sampling of Rock for Site Investigation
  - D 5079 Practices for Preserving and Transporting Rock Core Samples

#### 3. Terminology

- 3.1 For terminology used in this test method, refer to Terminology D 653.
- 3.2 Definitions of terms specific to this test method:
  - 3.2.1 Jar Slake Index,  $I_j$  – the visual determination of degradation of weak rock at some elapsed time after immersion in water or polymer slurry. This value is an integer ranging from 1 to 6.

#### 4. Significance and Use

- 4.1 The Jar Slake test is a simple test developed to determine the reaction of weak rock material to water and/or polymer slurry during a certain period of time which can be tested on irregular bulk samples. Results of this test have implications on the porosity, grain interactions and density of the material.
- 4.2 This test method is used to qualitatively estimate and assign durability values to weak rocks.

#### 5. Apparatus

- 5.1 300 ml to 600 ml clear glass laboratory jar, no taper.
- 5.2 Drying Apparatus – Any suitable device capable of drying samples at a temperature not exceeding 60°C [140°F].

#### 6. Test Sample and Specimen

- 6.1 Collect, transport, and store test samples in such manner to retain the natural water content using the guidelines in ASTM D 2113 and D 5079.
- 6.2 Test specimen shall be an air dried intact rock fragment with minimum dimensions of 25 mm × 25 mm and maximum dimensions of 65 mm × 50 mm. Specimen may be dried in an oven not exceeding 60°C [140°F].

## 7. Procedure

- 7.1 Place the specimen into an empty jar taking care not to break or fracture any part of it.
- 7.2 Photograph the specimen in the empty jar.
- 7.3 Add enough distilled water to cover the specimen by at least 15mm taking care not to disturb the specimen. A pre-mixed polymer slurry conforming to construction industry standards may be used in place of distilled water to investigate the retardation effects the polymer may have on the slaking process.
- 7.4 After two minutes of immersion, visually inspect the specimen to determine the Jar Slake Index,  $I_j$ , using the criteria contained in Table 1 and record the  $I_j$  for the reading.
- 7.5 Repeat Step 7.4 after 4, 6, 8, 10, 15, 20, 60, and 1440 minutes.
- 7.6 Take a final photograph of the specimen.

Jar Slake Index, $I_j$	General behavior during test
1	Degrades rapidly into a pile of flakes or mud
2	Breaks readily and/or forms many chips
3	Breaks slowly and/or forms few chips
4	Breaks rapidly and/or develops several fractures
5	Breaks slowly and/or develops few fractures
6	Very little or no change

### Jar Slake Index Descriptions

*Table 1*

## 8. Report

- 8.1 The report shall include the following:
  - 8.1.1 Specimen identification and description, test date, and test fluid used.
  - 8.1.2 Jar Slake Index value for all required readings.
  - 8.1.3 The Jar Slake Index Table (Table 1).
  - 8.1.4 Beginning and final photographs.

## WSDOT Test Method T 610

### Method of Test for the Capillary Rise of Soil

#### 1. Scope

- a. This test method describes the capillary rise test which determines the susceptibility of soil to damage by frost. The soil sample, closing the top of a glass tube, is subjected to the pull of an increasing head of water which compresses the soil and reduces its moisture content until air is forced through the soil by a maximum head which is termed the capillary rise.

#### 2. Equipment

- a. Capillary Apparatus – The capillary apparatus shall conform to the details shown in Figure 1 and shall consist of the following components:
  - (1) Glass Filter Tube – A glass filter tube, as detailed in Figure 1, fitted with a cork disk shaped to fit the shoulder of the tube and having a 1.57 in (40 mm) diameter hole in the center. A disk of No. 200 (0.075 mm) sieve is placed above the cork disk to retain the soil particles
  - (2) Glass Tube – A glass extension tube, 3.3 ft (1,000 mm) in length, and the same diameter as the lower part of the filter tube, connected to the filter tube by means of a short piece of rubber tubing.
  - (3) Glass Cylinder – A glass cylinder, 2 in (50 mm) in diameter and 4 ft (1220 mm) long, fitted with a single hole rubber stopper with a short piece of glass tubing, and a rubber hose about 3 ft (1 m) long with a clamp or other device for controlling the inlet-outlet flow of water.

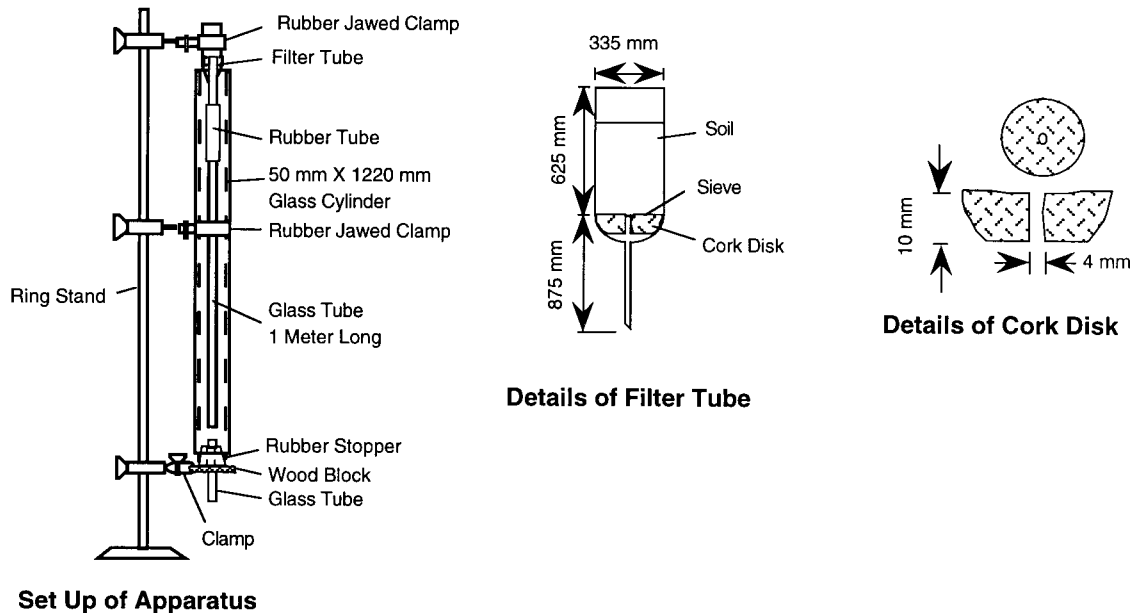

**Capillary Apparatus  
Figure 1**

### 3. Procedure

- a. Assemble the equipment as shown in Figure 1.
- b. Select from the material passing the No. 10 (2 mm) sieve a 200 g sample. Select from this 200-g sample a portion large enough to fill the filler tube, without tamping, to a height of 1.57 in (40 mm).
- c. Admit water into the jacket through the bottom tube until it is filled to a level slightly above the top of the soil in the filter tube and allow to stand for five minutes.
- d. After five minutes, lower the water until it is level with the bottom of the cork disk. Allow the excess water to drain from the soil
- e. After the excess water has drained from the soil, allow the water level in the jacket to drop slowly 2 in (50 mm) every five minutes until the water in the filter tube breaks.

### 4. Calculations

- a. The distance, in inches, between the top of the water in the jacket and the top of the soil when the water column in the tube breaks is reported as the capillary rise.

### 5. Reports

- a. All test results will be reported to the Soils Engineer.





## WSDOT Standard Operating Procedure SOP 615

### *Determination of the % Compaction for Embankment & Untreated Surfacing Materials Using the Nuclear Moisture-Density Gauge*

#### 1. Scope

This procedure covers the procedures for determining the in-place density, moisture content, gradation analysis, oversize correction, and determination of maximum density of compacted soils and untreated surfacing materials using a nuclear density device in the direct transmission mode.

#### 2. References

- a. AASHTO T 99 for Method of Test for Moisture-Density Relations of Soils
- b. AASHTO T 180 for Method of Test for Moisture-Density Relations of Soils
- c. [T 255](#) – WSDOT FOP for AASHTO for Total Moisture Content of Aggregate by Drying
- d. [T 272](#) – WSDOT FOP for AASHTO for Family of Curves – One Point Method
- e. [T 310](#) – WSDOT FOP for AASHTO for In-Place Densities and Moisture Content of Soils and Soil-Aggregate by Nuclear Methods (Shallow Depth)
- f. WAQTC TM 15 Laboratory Theoretical Maximum Dry Density of Granular Soil and Soil/Aggregate

#### 3. Test Location

When selecting a test location, the tester shall visually select a site where the least compactive effort has been applied. Select a test location where the gauge will be at least 6 in (150 mm) away from any vertical mass. If closer than 24 in (600 mm) to a vertical mass, such as in a trench, follow gauge manufacturer correction procedures.

When retesting is required due to a failing test; retest within a 10-foot radius of the original station and offset.

#### 4. Nuclear Density Test

Determine the dry density and moisture content of soils and untreated surfacing materials using the nuclear moisture-density gauge in accordance with WSDOT FOP for AASHTO T 310, and record in the Materials Testing System (MATS), WSDOT Form 350-074, Field Density Test, or other form approved in writing by the State Materials Engineer.

## 5. Oversize Determination

### a. AASHTO T 99 and WAQTC TM 15

A sample weighing a minimum of 4.08 kg (9 lbs) will be taken from beneath the gauge. Care shall be taken to select material that is truly representative of where the moisture density gauge determined the dry density and moisture content.

There are two methods for determining the percentage of material retained on the No. 4 sieve:

1. Method 1 – material that allows for the easy separation of fine and coarse aggregate.
  - a. Dry the sample until no visible free moisture is present (material may still appear damp but will not be shiny).
  - b. Determine and record the mass of the sample to the nearest 0.1 percent of the total mass or better.
  - c. Shake the sample by hand over a verified No. 4 (4.75 mm) sieve taking care not to overload the sieve. Overloading for a No. 4 (4.75 mm) sieve is defined as; A retained mass of more than 800 g (1.8 lbs), on a 12 inch sieve, or 340 g, (0.75 lbs); on an 8 inch sieve after sieving is complete.

**Note 1:** If the tester suspects a sieve will be overloaded the sample can be separated into smaller increments and recombined after sieving.
  - d. Determine and record the mass of the material retained on the No. 4 (4.75 mm) sieve to the nearest 0.1 percent of the total mass or better and record.
2. Method 2 – recommended for crushed surfacing materials, materials with high clay content, or other granular materials that are at or near the optimum moisture content for compaction.
  - a. Determine and record the mass of the sample to the nearest 0.1 percent of the total mass or better and record.
  - b. Shake sample by hand over a verified No. 4 (4.75 mm) sieve. Do not overload the sieve. (See Section 1a and Note 1 for overload definition and information on how to prevent overloading of a sieve)
  - c. Shake material until no particles are observed passing the No. 4 (4.75 mm) sieve
  - d. Rinse the sample with water
  - e. Continue rinsing the material until it is visibly free of any coating or minus No. 4 material.
  - f. Place the washed material, retained on the No. 4 (4.75 mm) sieve, into a tared container and blot until no visible free moisture is present on the material (material may still appear damp but will not appear shiny).
  - g. Determine and record the mass of the material retained on the No. 4 (4.75 mm) sieve to the nearest 0.1 percent of the total mass or better.

## b. AASHTO T 180

1. Follow either Method 1 or Method 2 in 5 a. with the following exception; sieve the material over a  $\frac{3}{4}$  in (19.0 mm) sieve.
2. Do not overload the  $\frac{3}{4}$ " (19.0 mm) sieve. Overloading of a  $\frac{3}{4}$ " (19.0 mm) sieve is defined as: A retained mass of more than 3.2 kg (7.04 pounds) on a 12 inch sieve or 1.4 kg (3.08 pounds) on an 8 inch sieve after sieving is complete.

## 6. Calculations

- a. Calculate the percent retained as follows:

$$\% \text{ retained (P}_c\text{)} = 100 \times \frac{\text{mass retained on sieve}}{\text{original mass}} \text{ (round to nearest percent)}$$

- b. Calculate percent passing as follows:

$$\% \text{ passing} = 100 - \% \text{ retained}$$

- c. Calculate the dry density as follows:

$$d = \frac{100}{100 + W} (m)$$

Where:

- d = dry field density of total sample, pcf  
 m = total field wet density, pcf  
 W = moisture content of total field sample

- d. Calculate the corrected theoretical maximum density as follows:

$$D_d = \frac{100 \times (D_f) \times (k)}{[(D_f) \times (P_c) + (k) \times (P_f)]}$$

Where:

- $D_d$  = corrected dry density of combined fine and oversized particles, expressed as lbs/ft<sup>3</sup>.  
 $D_f$  = dry density of fine particles expressed as lbs/ft<sup>3</sup>, determined in lab.  
 $P_c$  = percent of coarse particles, by weight.  
 $P_f$  = percent of fine particles, by weight.  
 k = 62.4 x Bulk Specific Gravity.

Calculate in-place dry density to the nearest 0.1 lbs/ft<sup>3</sup>.

**Note 2:** If the specific gravity of the coarse particles has been determined, use this value in the calculation for the "k" value. If the specific gravity is unknown then use 2.67. Either AASHTO T 85 or WAQTC TM 15 Apparent Specific Gravity may be used to determine the specific gravity of the coarse particles.

- e. Calculate the percent of compaction using the following equation:

$$\% \text{ compaction} = \frac{\text{Dry Density (lbs/ft}^3\text{)}}{\text{corrected theoretical maximum density (lbs/ft}^3\text{)}}$$

## 7. Density Curve Tables

The Materials Testing System (MATS) Density Curve Tables is the WSDOT preferred method for determining the corrected theoretical maximum density.

- a. MATS calculates the corrected theoretical maximum density in accordance with AASHTO T 99 and T 180 ANNEX A1. (Correction of Maximum Dry Density and Optimum Moisture for Oversized Particles) and reports the results in the Density Curve Table.
- b. To determine the corrected theoretical maximum density using the Density Curves Table enter the Table at the line corresponding to the % passing or % retained (T 99 & T 180 requires percent retained, TM 15 requires percent passing), read across to the column labeled Max this number is the Corrected Theoretical Maximum Density.

## 8. Report

- a. Report the results using one or more of the following:
  - Materials Testing System (MATS)
  - WSDOT Form 350-074 and 351-015
  - Form approved in writing by the State Materials Engineer
- b. Report the percent of compaction to the nearest whole number.

## Performance Exam Checklist

### WSDOT Standard Operating Procedure SOP 615

#### ***Determination of the % Compaction for Embankment & Untreated Surfacing Materials Using the Nuclear Moisture-Density Gauge***

Participant Name: \_\_\_\_\_ Exam Date: \_\_\_\_\_

Record the symbols "P" for passing or "F" for failing on each step of the checklist.

Procedure Element	Trial 1	Trial 2
1. The tester has a copy of the current procedure on hand?	_____	_____
2. All equipment is functioning according to the test procedure, and if required, has the current calibration/verification tags present?	_____	_____
<b>Gradation Analysis</b>		
<b>3(A) Method 1</b>		
1. Sample Dried to a SSD condition (dried until no visible free moisture present) and mass recorded?	_____	_____
2. Sample allowed to cool sufficiently prior to sieving?	_____	_____
3. Sample was shaken by hand through the appropriate sieve for a sufficient period of time?	_____	_____
4. Recorded mass of material retained on the appropriate sieve?	_____	_____
5. Calculated and recorded percent of material retained and passing the appropriate sieve?	_____	_____
<b>3(B) Method 2</b>		
1. Mass of sample determined prior to washing?	_____	_____
2. Material charged with water in suitable container and agitated to suspend fines?	_____	_____
3. Sample decanted over required sieve for a sufficient amount of time without overloading sieve?	_____	_____
4. Retained material dried to SSD condition and mass determined?	_____	_____
5. Recorded mass of material retained on appropriate sieve?	_____	_____
6. Calculated and recorded percent of material retained and passing appropriate sieve?	_____	_____
<b>Correction for Coarse Particles</b>		
7. Appropriate MATS Density Curve Table used to determine the corrected theoretical maximum density, based on the percent passing or retained on the appropriate sieve?	_____	_____
8. All calculations performed correctly?	_____	_____

Comments: First Attempt: Pass \_\_\_\_\_ Fail \_\_\_\_\_ Second Attempt: Pass \_\_\_\_\_ Fail \_\_\_\_\_

Examiner Signature: \_\_\_\_\_ WAQTC #: \_\_\_\_\_



---

---

## WSDOT Test Method T 716

### *Method of Random Sampling for Locations of Testing and Sampling Sites*

#### A. Scope

1. This method outlines the procedure for selecting sampling and testing sites in accordance with accepted random sampling techniques. It is intended that all testing and sampling locations be selected in an unbiased manner based entirely on chance.
2. Testing and sampling locations and procedures are as important as testing. For test results or measurements to be meaningful, it is necessary that the sampling locations be selected at random, typically by use of a table of random numbers. Other techniques yielding a system of randomly selected locations are also acceptable.

#### B. Summary of Method for Selecting Random Test Location

- Method A – Determining a Random Location for Hot Mixture Asphalt (HMA) Density Tests
- Method B – Determining Random Test Location for Sampling HMA Mix, Aggregates, and Miscellaneous Materials
- Method C – Determining Random Test Location for Portland Cement Concrete
- Appendix A – Hot Mix Asphalt Density Test Locations for Irregular Paving Areas

#### C. Procedure for Determining Random Test/Sampling Location

##### Method A – Selection of Random Location for HMA Density

##### 1. Stationing

This method outlines the procedure for determining the random location of HMA Density testing sites using stationing.

Calculate the linear foot distance for tons specified per subplot (i.e. 80 or 100 ton sublots).

Equations:

$$\text{Sublot length (ft)} = \frac{\text{Sublot quantity (tons)}}{\left(\frac{\text{width (ft)} \times \text{depth (ft)} \times 2.05 \text{ tons}}{27}\right)}$$

- a. Use a random number generator (i.e. calculator, computer) or a random number determined by a stopwatch (See Note 1) to enter Table 1. Use the corresponding X value to determine the test station. A new X value is required for every test.

**Note 1:** To use the stopwatch method, randomly start and stop the stopwatch 10 or more times, then use the decimal part of the seconds as your entry point.

- b. Determine the test station as follows:

Test Station = (sublot length × “X” multiplier) + beginning station of paving (round to the nearest foot)

- c. Use a random number generator (i.e. calculator, computer) or a random number determined by a stopwatch (See Note 1) to enter Table 2. Use the corresponding “Y” multiplier to determine the offset. A new “Y” multiplier is required for every test.

- d. Determine the offset as follows:

Offset = (width of pavement × “Y” multiplier) (round to the nearest 0.1 ft)

Offset may be figured from the right or left edge of pavement. Tester shall indicate in MATS or approved density form from which edge the offset is measured.

- e. If a tester must move a testing location due to an obstruction of other interference, a new random number for the offset and station shall be picked and the location recalculate. Document the new location and the reason the testing location was changed.

**Example for a 100 ton sublot:**

Given:

Paving width = 12 ft

Paving depth = 0.15 ft

Beginning Station = 10 + 00

Offset from left edge of pavement

**Calculations:**

$$\text{Sublot length} = \frac{100}{\left(\frac{12 \times 0.15 \times 2.05}{27}\right)} = 731.7 \text{ lf}$$

Ending Station = (Beginning Station + Sublot length) = (1000 + 731.7) = 17 + 32

Random generated number = X=25, Y=10

Beginning Test Location

Enter Table 1 at (25): “X” multiplier = 0.080

Enter Table 2 at (10): “Y” multiplier 0.167

Testing Station = (732 × 0.080) + 1000 = 1058.5 = 10 + 59 (round to the nearest ft)

Offset = (12 × 0.167) = 2.00 = 2.0 ft left of pavement edge (round to the nearest 0.1 ft)



## 2. Milepost

This method outlines the procedure for determining the random location of HMA Density testing sites using mileposts.

- a. Convert to tons per mile using the roadway area based on the roadway width and depth.

Equations:

$$\text{Sublot length (mile)} = \frac{\text{Sublot quantity (tons)}}{\left(\frac{\text{width (ft)} \times \text{depth (ft)} \times 2.05 \text{ tons}}{27}\right) \times 5280 \text{ lf}}$$

**Round sublot length to the nearest thousandth (0.001) of a mile**

Calculate the location of the test site and offset using the same method as described in Method A Stationing except use tons per mile instead of the tons per lf.

$$\text{Test site} = (\text{sublot length} \times \text{“X” multiplier}) + \text{beginning milepost}$$

$$\text{Offset} = (\text{width} \times \text{“Y” multiplier})$$

**Example for 100-ton sublot:**

Given:

Paving width = 12 ft

Paving depth = 0.15 ft

Beginning Milepost (MP) = 1.00

Offset determined from right side of pavement

**Calculations:**

$$\text{Sublot length} = \frac{100}{\left(\frac{12 \times 0.15 \times 2.05}{27}\right) \times 5280} = 0.138$$

Ending MP = (Beginning MP + Sublot length) = (1.00 + 0.138) = 1.138

Random generated number = X=25, Y=90

Beginning Test Location

Enter Table 1 at (25): “X” multiplier = 0.080

Enter Table 2 at (90): “Y” multiplier = 0.060

Testing MP = (.138 × 0.080) + 1.00 = 1.011

Offset = (12 × 0.060) = 0.72 = 0.72 ft right of edge of pavement

Random #	X	Random #	X	Random #	X	Random #	X
1	0.794	26	0.526	51	0.304	76	0.617
2	0.500	27	0.519	52	0.167	77	0.584
3	0.393	28	0.446	53	0.308	78	0.591
4	0.427	29	0.219	54	0.570	79	0.563
5	0.165	30	0.780	55	0.322	80	0.482
6	0.821	31	0.574	56	0.491	81	0.499
7	0.562	32	0.730	57	0.349	82	0.227
8	0.284	33	0.435	58	0.681	83	0.476
9	0.704	34	0.338	59	0.858	84	0.258
10	0.988	35	0.515	60	0.716	85	0.227
11	0.692	36	0.751	61	0.521	86	0.364
12	0.491	37	0.063	62	0.568	87	0.186
13	0.769	38	0.269	63	0.168	88	0.791
14	0.675	39	0.357	64	0.460	89	0.985
15	0.205	40	0.555	65	0.708	90	0.562
16	0.187	41	0.837	66	0.453	91	0.753
17	0.238	42	0.699	67	0.778	92	0.097
18	0.400	43	0.456	68	0.484	93	0.723
19	0.263	44	0.730	69	0.609	94	0.214
20	0.545	45	0.314	70	0.949	95	0.215
21	0.230	46	0.179	71	0.575	96	0.428
22	0.700	47	0.152	72	0.263	97	0.647
23	0.616	48	0.334	73	0.192	98	0.794
24	0.179	49	0.284	74	0.845	99	0.154
25	0.080	50	0.819	75	0.095	100	0.964

**Random Number - X**  
**Table 1**

Random #	Y	Random #	Y	Random #	Y	Random #	Y
1	0.823	26	0.755	51	0.068	76	0.298
2	0.646	27	0.922	52	0.709	77	0.217
3	0.928	28	0.299	53	0.742	78	0.662
4	0.247	29	0.855	54	0.704	79	0.709
5	0.742	30	0.270	55	0.230	80	0.634
6	0.666	31	0.875	56	0.584	81	0.245
7	0.624	32	0.076	57	0.663	82	0.672
8	0.553	33	0.393	58	0.727	83	0.620
9	0.311	34	0.366	59	0.559	84	0.580
10	0.167	35	0.860	60	0.907	85	0.452
11	0.198	36	0.605	61	0.311	86	0.141
12	0.814	37	0.239	62	0.665	87	0.937
13	0.876	38	0.349	63	0.134	88	0.228
14	0.356	39	0.201	64	0.241	89	0.225
15	0.898	40	0.650	65	0.384	90	0.060
16	0.141	41	0.822	66	0.268	91	0.820
17	0.913	42	0.157	67	0.629	92	0.883
18	0.384	43	0.799	68	0.227	93	0.528
19	0.815	44	0.340	69	0.187	94	0.749
20	0.761	45	0.479	70	0.167	95	0.441
21	0.370	46	0.925	71	0.127	96	0.221
22	0.156	47	0.494	72	0.288	97	0.863
23	0.397	48	0.833	73	0.436	98	0.082
24	0.416	49	0.128	74	0.913	99	0.467
25	0.705	50	0.294	75	0.665	100	0.828

**Random Number - Y**  
**Table 2**

**Method B – Hot Mix Asphalt (HMA) Pavement Mixture or Aggregates**

1. Determine the subplot increment of the material.
2. Use a random number generator (i.e. calculator, computer, etc) or a random number determined by a stopwatch (See Note 1) to enter Table 1. Use the corresponding X multiplier to determine the offset.
3. A new X multiplier is required for every subplot.
4. Random sample tonnage may be adjusted per subplot to accommodate field testing. Adjustments to random sample tonnage must be documented.
5. Calculate the location of the sampling site as follows:

**Equations:**

First Sample Site = Sublot increment  $\times$  “X” multiplier (Table 1)

Subsequent Sites = (subplot increment + (Sublot increment  $\times$  “X” multiplier))

**Aggregate Sample Example:**

Given: Crushed Surfacing Base Coarse

Random sample frequency per 9-3.7 = 1 per 2,000 tons.

Calculate the location of the first random sample site as follows:

The computer-generated number is 22.

Sublot Increment (Frequency of sampling) = 2,000 tons

Enter Table 1 at (22) “X” = 0.700

Sampling Site =  $2000 \times 0.700 = 1400$  tons

**Calculate subsequent sample sites as follows:**

The computer-generated number is (53).

Sublot Increment (Frequency of sampling) = 2,000 tons

Enter Table 1 at 53 “X” = 0.308

Sampling Site =  $2000 + (2000 \times 0.308) = 2616$  tons

**Method C Portland Cement Concrete (PCC)**

1. Determine subsequent random sampling locations as follows:

a. Example for less than 100 cubic yards remaining after reducing frequency:

- (1) Determine amount of pour remaining this will be the subplot increment
- (2) Use a random number generator (i.e. calculator, computer) or a random number determined by a stopwatch (See Note 1) to enter Table 1. Use the corresponding X multiplier to determine the test station. A new X multiplier is required for every test.
- (3) Determine the sample location as follows:

$$\text{Sampling Location} = \text{Concrete remaining} \times \text{"X" multiplier (Table 1)}$$

**Given:**

Total cubic yards (cy) of concrete placement = 80 cy

Truckload = 10 cy

Given: First truck is in specification = 10 cy

Remaining cubic yards = 80 cy - 10 cy = 70 cy < 100 cy

Sublot increment = 70 cy

Random number = 30 "X" = 0.780

Sampling Location = 70 cy  $\times$  0.780 = 54.6 = 55 cy or 7th truck

b. Example for greater than 100 cubic yards remaining after reducing frequency

(1) **Given:**

Pour = 130 cy

Each truck carries 8 cy of concrete

First truck is in specification = 8 cy

Remaining cubic yards = 130 - 8 = 122 > 100 cy

Sublot Increment = 100 cy

- (2) Use a random number generator (i.e. calculator, computer) or a random number determined by a stopwatch (See Note 1) to enter Table 1. Use the corresponding X value to determine the test station. A new X value is required for every test.
- (3) Determine the sample location as follows:

$$\text{Sampling Location} = \text{Sublot increment} \times \text{"X" multiplier (Table 1)}$$

**Example:**

Random number = 15 "X" = 0.205

Sample location = 100 cy  $\times$  0.205 = 20.5

Determine where the first sample will be taken:

Testing location = (accumulated cy of last truck sampled) + sample yardage

**Example:**

First Sample Location:

Accumulated cy **first** truck = 8

Sample location = 8 cy + 20.5 cy = 28.5 cy

Truck load =  $28.5/8 = 4$

Sampling = **second** half of 4th truck

Determine subsequent sampling locations as follows:

Sublot increment = total pour – (initial loads in specification)-(first subplot increment)

Sublot increment = 130 cy – (8 cy) – (100 cy) = 22 cy

Random number = 52 “X” = 0.167

Testing location = (initial load in specification) + (first subplot increment) +  
(testing location within the second subplot)

Testing location = (8 cy)+(100 cy)+(0.167 × 22 cy)

Testing location = 111.7 cy or  $111.7/8$  cy per truck = 14.0 = 14th truck

**3. Report**

- a. Report the random number used to determine station and offset
- b. Document any changes in station or offset of random testing location
- c. Use one of the following to report random location information:
  - Materials Testing System (MATS)
  - Form approved in writing by the State Materials Engineer

## Appendix A

### Hot Mix Asphalt Density Test Locations for Irregular Paving Areas

- A. Track tonnage placed in the irregular shaped area until specified tons are placed, note the stationing.
- B. Measure back to the beginning of the paving or end of the previous lot to obtain the length (this is also your beginning station).
- C. Use a computer-generated random number or a random number determined by a stopwatch (See Note 1) to enter Table 1. Use the corresponding X value to determine the test station. A new X value is required for every test.
- D. Multiply the length by the “X” value and add to the beginning station to locate your testing site.
- E. Use a computer-generated random number or a random number determined by a stopwatch (See Note 1) to enter Table 2. Use the corresponding Y value to determine the offset. A new Y value is required for every test.
- F. Measure the width at the testing station and multiply the width time the “Y” value to determine the offset of the testing site.
- G. Make a sketch of the area to document the test location in the event a retest is required.

#### **Example:**

Paving began at Station 101 + 00.

The tester determined Station 105 + 75 was the end of the 100 ton lot.

The width of the pavement began at 0 and transitioned to 12.

#### **Testing Station**

$$\text{Sta } 105 + 75 - \text{Sta } 101 + 00 = 475 \text{ ft}$$

$$\text{Random number} = 45, \text{ “X” value} = 0.314$$

$$475 \text{ ft} \times 0.314 = 149.15 = 149 \quad \text{Testing station} = 10100 + 149 = 102 + 49$$

#### **Testing Offset**

Measure width at station 102 + 49

$$\text{Width} = 3.76$$

$$\text{Random \# } 65 \text{ “Y” value} = 0.384$$

$$\text{Offset} = 3.76 \times 0.384 = 1.44 = 1.4 \text{ ft from right edge}$$







## WSDOT Test Method T 720

### *Method of Test for Thickness Measurement for Hot Mix Asphalt (HMA) Cores*

#### 1. Scope

- a. This procedure is used to determine the thickness of the lifts in a Hot Mix Asphalt core.

#### 2. Apparatus

- a. Protection goggles, safety shield, or safety glasses.
- b. Hatchet.
- c. Striking tool such as a hammer, sledge, or maul suitable for striking the hatchet to separate the lifts.
- d. Tape, rule, calipers, or a measuring device suitable for measuring core lifts to 0.01 LF (3 mm).
- e. Hard stable surface, such as a cement concrete table, on which to place core for striking.
- f. Hard rubber pad.

#### 3. Procedure

- a. Measure the total thickness of the core as received to 0.01 LF (3 mm).
- b. Carefully remove all crushed surfacing top course, old pavement, prelevel, and prime coat from the core with the hatchet and striking tool.
- c. Measure the total thickness of the remaining core to 0.01 LF (3 mm).
- d. Split off the individual pavement lifts by placing core on the hard rubber pad, on the hard stable surface. Place the hatchet on the lift line and striking with the striking tool at several points around the core. Care must be taken in order to get a clean split of the core at the lift line and not damage the core.

**Note:** Lift lines are often more visible by rolling the core on a flat surface. Chilling the cores may aid in splitting lifts.

- e. Each lift shall be measured from a plane surface to a plane surface. Two or more measurements shall be taken around the lift and the average shall be reported to 0.01 LF (3 mm) for each lift in the core.

**Note:** The top lift is designated as lift number one. Each subsequent lift shall be designated as lifts 2, 3, 4, etc.

#### 4. Report

Report the results of the thickness measurements in the Materials Testing System (MATS)





---

## WSDOT SOP 729

### *Determination of the Moving Average of Theoretical Maximum Density (TMD) for HMA*

#### 1. Scope

This procedure covers the process for obtaining the moving average of the Theoretical Maximum Density (TMD) for calculating pavement compaction in accordance with WSDOT FOP for WAQTC T 355. The TMD is to be determined in accordance with WSDOT FOP for AASHTO T 209.

#### 2. Procedure

The procedure for determining the moving average of TMD is as follows:

- a. On the initial day of production of a new Job Mix Formula, two determinations shall be made to establish an initial average value. The samples shall not be from the same truck. Average the two TMDs and report the result to the Moisture Density Gauge Operator. The TMD value from the Mix Design Verification Report shall not be included in the average. If the two TMDs determined on the initial day do not agree within 1.5 lb/ft<sup>3</sup> (24 kg/m<sup>3</sup>), a third determination shall be made. The initial average density shall be based on the two closest results.
- b. A TMD test shall be taken with each mix sample. The moving average is defined as the average of the last five TMD values for the HMA being placed. Until five TMD values have been determined, the moving average will consist of all previous TMD values plus the first TMD value for the current production shift. When five TMD values have been determined, the moving average for each shift will include the last four TMD values plus the first TMD value for the current paving shift. This new moving average value will be used for the entire paving shift.
- c. Each TMD shall be compared with the previously computed moving average. If a TMD deviates from the moving average by more than 1.5 lb/ft<sup>3</sup> ( $\pm 24$  kg/m<sup>3</sup>), a second test shall be made on another portion of the same sample. If the second TMD agrees within 1.5 lb/ft<sup>3</sup> ( $\pm 24$  kg/m<sup>3</sup>) of the moving average then the first TMD will be discarded and the second TMD will be included in the moving average. If the second TMD is not within 1.5 lb/ft<sup>3</sup> ( $\pm 24$  kg/m<sup>3</sup>) of the moving average but is within 1.5 lb/ft<sup>3</sup> ( $\pm 24$  kg/m<sup>3</sup>) of the first TMD, a new moving average will be initiated, discarding all previous results. The new moving average will be sent to the Moisture Density Gauge operator and will replace the current moving average.
- d. A moving average will be sent to the Moisture Density Gauge operator once per production shift, unless two tests during a shift are not within 1.5 lb/ft<sup>3</sup> ( $\pm 24$  kg/m<sup>3</sup>), then a new moving average will be calculated in accordance with “c” of this procedure and sent to the Moisture Density Gauge operator as the new moving average for the shift. The Moisture Density Gauge Operator will continue to use the previous moving average until a new moving average is available.

#### 3. Report

The gauge operator will record the average TMD received from the tester at the HMA plant on WSDOT Form [350-092](#) and [350-157](#) or in the MATS database. The average TMD will be used in WSDOT FOP for WAQTC T 355 to calculate the percent of compaction for statistical evaluation.





## WSDOT SOP 730

### *Correlation of Nuclear Gauge Densities With Hot Mix Asphalt (HMA) Cores*

1. When evaluating HMA compaction:

1.1 A gauge correlation is required:

- a. For each combination of gauge and HMA Mix Design (initial JMF).
- b. When gauge mode changes (i.e., back scatter to thin layer).
- c. When wearing course lift thickness changes per Note 1.
- d. When a gauge is recalibrated.

**Note 1:** For density determined with "Thin Layer Mode," a layer thickness change of greater than 0.08 feet requires a new correlation. For density determined with "Back Scatter Mode," a layer thickness change of greater than 0.15 feet requires a new gauge correlation.

1.2 A gauge correlation is not required but may be considered by the Regional Materials Engineer when:

- a. Base material changes from the original correlation base (i.e., from a surfacing base to an asphalt base).
- b. The same gauge HMA Mix Design (Reference Mix Design) combination are used on a different contract within the same construction year.
- c. When JMF has been adjusted in accordance with [Standard Specifications](#) Section 9-03.8(7)A.

2. Gauge correlation is based on ten in-place HMA densities and ten cores taken at the same location as the in-place density.
  - 2.1 In-place HMA densities shall be determined in accordance with WSDOT FOP for WAQTC T 355.
  - 2.2 Cores should be taken no later than the day following paving and before traffic has been allowed on roadway. Correlation cores are not required to be taken at record density locations. Therefore, a site outside the traveled way should be considered for worker safety, as long as the lift thickness matches that of the plan lift thickness of the record density locations.

**Note 2:** If a core becomes damaged, it shall be eliminated from the average.

**Note 3:** Cores may be taken sooner than the day after paving if the HMA is cooled to prevent damage during coring and removal of cores. Water, ice, or dry-ice may be used to cool the pavement. Another method of cooling that may be used is substitution of nitrogen gas or CO<sub>2</sub> for drilling fluids.

3. Obtain a pavement core from each of the test sites in accordance with WSDOT SOP 734. The core shall be taken in the nuclear gauge footprint.
  - 3.1 For either gauge mode, back scatter or thin layer, locate the core in the approximate center of the nuclear gauge footprint. If the core thickness exceeds the plan pavement thickness by more than 0.04 feet, then the core shall be saw cut to the plan thickness prior to performing density testing. If a core thickness is less than the plan thickness by more than 0.04 feet, it shall be eliminated from the average.
4. Bulk Specific Gravity ( $G_{mb}$ ) of core shall be determined in conformance with WSDOT FOP for AASHTO T 166 Bulk Specific Gravity of Compacted Hot Mix Asphalt (HMA) Using Saturated Surface-Dry Specimens.

Calculate core density as follows, round to the nearest 0.1 pcf:

$$\text{Core Density} = G_{mb} \times 62.245 \text{ pcf}$$

Calculate gauge correlation factor as follows:

$$\text{Density Ratio} = \frac{(\text{core density})}{(\text{nuclear gauge wet density})}$$

Round Density Ratio to the nearest 0.001

$$\text{Gauge correlation factor} = \frac{(\text{Sum of ratios})}{(\text{number of cores})}$$

5. Gauge Correlation Factor shall be determined to 0.001.
6. Report the Gauge Correlation Factor using MATS or DOT [Form 350-112](#).



## WSDOT SOP 731

### *Method for Determining Volumetric Properties of Hot Mix Asphalt*

#### 1. Scope

This procedure covers the determination of volumetric properties of Hot Mix Asphalt, i.e., Air Voids ( $V_a$ ), Voids in Mineral Aggregate (VMA), Voids Filled with Asphalt (VFA), and Dust to Binder Ratio ( $P_{\#200}/P_{be}$ ).

#### 2. References

T 329	WSDOT FOP for AASHTO Moisture Content of Hot Mix Asphalt (HMA) by Oven Method
T 27/11	WSDOT FOP for WAQTC/AASHTO Sieve Analysis of Fine and Coarse Aggregates
T 166	WSDOT FOP for AASHTO Bulk Specific Gravity of Compacted Hot Mix Asphalt Using Saturated Surface-Dry Specimens
R 97	FOP for AASHTO Sampling of Asphalt Mixtures
T 209	WSDOT FOP for AASHTO Theoretical Maximum Specific Gravity and Density of Hot Mix Asphalt Paving Mixtures
T 308	WSDOT FOP for AASHTO Determining the Asphalt Binder Content of Hot Mix Asphalt (HMA) by the Ignition Method
T 312	WSDOT FOP for AASHTO Preparing Hot Mix Asphalt (HMA) Specimens by Means of the Superpave Gyratory Compactor
R 47	WSDOT Errata to FOP for AASHTO Reducing Samples of Asphalt Mixtures to Testing Size
T 30	WAQTC Errata to FOP for AASHTO Mechanical Analysis of Extracted Aggregate

#### 3. Calibration of Compactor

- a. The gyratory compactor will be calibrated in accordance with WSDOT VP-58 and according to the manufacturer's established calibration procedure. Anytime the gyratory compactor is moved to a new testing site a new calibration is required in accordance with WSDOT VP-58.

#### 4. Test Samples

- a. All test samples shall be obtained per FOP for AASHTO R 97, and reduced in accordance with WSDOT Errata to FOP for AASHTO R 47. It is recommended that the gyratory test sample be the first sample acquired in order to minimize heat loss.
- b. The size of the gyratory sample shall be such that it will produce a compacted specimen  $115.0 \pm 5.0$  mm in height. Generally, the mix design verification report from the State Materials Laboratory initial starting mass is adequate.
- c. Place the gyratory sample in an oven set no more than  $25^{\circ}$  F above the compaction temperature (Note 1) as soon as possible to reduce sample cooling. The gyratory test is temperature sensitive. The sample should be heated five degrees above the compaction temperature as shown on the mix design verification report.

**Note 1:** Any change in compaction temperature must be confirmed by the temperature viscosity chart provided by the asphalt supplier, which can be obtained from the Paving Contractor.

#### 5. Procedure

- a. Place a compaction mold, base plate, and top plate (if required), in an oven set at no more than  $350^{\circ}$ F for a minimum of 30 minutes prior to the estimated beginning of compaction. Subsequent uses of a conditioned mold will require 5 minutes of reheating.
- b. Place a thermometer into the center of the mix, do not stir the mixture. (Note 3) Compact the sample immediately upon achieving  $5^{\circ}$  F over compaction temperature in accordance with step 4 (c).

**Note 2:** While the gyratory test sample is heating it is beneficial to prepare and/or run the other tests as times permits.

- c. Perform the sample compaction in accordance with WSDOT FOP for AASHTO T 312 Section 9.
- d. Determine theoretical maximum density per WSDOT FOP for AASHTO T 209.
- e. Determine asphalt content and gradation per WSDOT FOP for AASHTO T 308 and WAQTC Errata to FOP for AASHTO T 30.
- f. Determine moisture content per WSDOT FOP for AASHTO T 329.
- g. Allow the gyratory compacted specimen to cool in air to  $25 \pm 5^{\circ}$ C ( $77 \pm 9^{\circ}$ F). Determine the Bulk Specific Gravity (Gmb) of the specimen in accordance with WSDOT FOP for AASHTO T 166 Method A.

**Note 3:** For repeatability between operators the retest sample should be cooled for the same amount of time at room temperature as the original specimen. When sending retest samples to the Region or State Laboratory, note the time the original sample was cooled at room temperature in the remarks section of the transmittal.



## 6. Volumetric Calculations

### Calculations

- a. Calculate  $\%G_{mm} @ N_{design}$  as follows:

$$\%G_{mm} @ N_{design} = \frac{G_{mb}}{G_{mm}} \times 100$$

Example:

$$\%G_{mm} @ N_{design} = \frac{2.383}{2.493} \times 100 = 95.6\%$$

Where:

$\%G_{mm} @ N_{design}$  = % theoretical maximum specific gravity @  $N_{design}$

$G_{mb}$  = Bulk specific gravity of the compacted specimen

$G_{mm}$  = Maximum specific gravity of the paving mixture

$N_{design}$  = Number of design gyrations

- b. Calculate  $\%G_{mm} @ N_{ini}$  as follows:

$$\%G_{mm} @ N_{ini} = 100 \times \left( \frac{G_{mb} \times h_d}{G_{mm} \times h_i} \right)$$

Example:

$$\%G_{mm} @ N_{ini} = 100 \times \left( \frac{2.383 \times 110.0}{2.493 \times 123.1} \right) = 85.4\%$$

Where:

$\%G_{mm} @ N_{ini}$  = Percent theoretical maximum specific gravity @  $N_{initial}$

$h_d$  = Height of specimen at design gyration level

$h_i$  = Height of specimen at initial design gyration level

$N_{initial}$  = Number of initial gyrations

- c. Calculate Air Voids ( $V_a$ ) as follow:

$$V_a = 100 \times \left( 1 - \left( \frac{G_{mb}}{G_{mm}} \right) \right)$$

Example:

$$V_a = 100 \times \left( 1 - \left( \frac{2.383}{2.493} \right) \right) = 4.4\%$$

Where:

$V_a$  = Percent air voids

- d. Calculate Voids in Mineral Aggregate (VMA) as follows:

Example:

$$VMA = 100 - \left( \frac{(G_{mb} \times P_s)}{G_{sb}} \right)$$

$$VMA = 100 - \left( \frac{(2.383 \times 94.8)}{2.630} \right) = 14.1\%$$

Where:

$P_s$  = Percent of aggregate in the mixture (100- $P_b$ )

Example:

100% mix - 5.2% asphalt = 94.8% aggregate

Where:

$G_{sb}$  = Bulk specific gravity of the combined aggregate

VMA = Voids in Mineral Aggregate, percent

- e. Calculate Voids Filled with Asphalt (VFA) as follows:

Example:

$$VFA = 100 \times \left( \frac{VMA - V_a}{VMA} \right)$$

$$VFA = 100 \times \left( \frac{14.1 - 4.4}{14.1} \right) = 68.8\%$$

Where:

VFA = Voids Filled with Asphalt, percent

- f. Calculate Gravity Stone Effective ( $G_{se}$ ) as follows:

Example:

$$G_{se} = \frac{100 - P_b}{\left( \frac{100}{G_{mm}} - \frac{P_b}{G_b} \right)}$$

$$G_{se} = \frac{100 - 5.2}{\left( \frac{100}{2.493} - \frac{5.2}{1.025} \right)} = 2.706$$

Where:

$G_{se}$  = Gravity Stone Effective (specific gravity of aggregates, excluding voids permeable to asphalt)

$P_b$  = Percent of binder

$G_b$  = Gravity binder

**Note 4:**  $G_b$  is the specific gravity of the asphalt binder. It is imperative that current  $G_b$  is used in the volumetric calculations. Any changes in the binder specific gravity must be confirmed by the temperature viscosity curve provided by the asphalt supplier, which can be obtained from the paving Contractor.

g. Calculate Percent Binder Effective ( $P_{be}$ ) as follows:

Example:

$$P_{be} = P_b - \left( \frac{(P_s \times G_b)(G_{se} - G_{sb})}{(G_{se} \times G_{sb})} \right) \quad P_{be} = 5.2 - \left( \frac{(94.8 \times 1.025)(2.706 - 2.630)}{(2.706 \times 2.630)} \right) = 4.2$$

Where:

- $P_{be}$  = Percent binder effective, the percent by mass of effective asphalt content minus the quantity of binder lost by absorption into the aggregate particles.
- $P_s$  = Percent of aggregate in the mixture
- $G_b$  = Gravity binder
- $G_{se}$  = Effective specific gravity of the aggregate
- $G_{sb}$  = Bulk specific gravity of the combined aggregate
- $P_b$  = Percent of binder

h. Calculate dust-to-binder ratio ( $P_{200}/P_{be}$ ) as follows:

Example:

$$P_{200}/P_{be} = P_{200} \div P_{be} \quad 5.0 \div 3.6 = 1.4$$

Where:

- $P_{200}/P_{be}$  = Dust-to-binder ratio
- $P_{200}$  = Percent of aggregate passing the No. 200 sieve

## 7. Report

Report the results using one or more of the following of the following:

- Materials Testing System (MATS)
- WSDOT [Form 350-560](#) for asphalt content, gradation, and moisture content
- WSDOT [Form 350-162](#) for volumetric properties
- Form approved in writing by the State Materials Engineer





## WSDOT SOP 732<sup>1</sup>

### *Volumetric Design for Hot-Mix Asphalt (HMA)*

#### 1. Scope

- 1.1 This standard for mix design evaluation uses aggregate and mixture properties to produce a hot-mix asphalt (HMA) job-mix formula. The mix design is based on the volumetric properties of the HMA in terms of the air voids ( $V_a$ ), voids in the mineral aggregate (VMA), and voids filled with asphalt (VFA).
- 1.3 This standard may involve hazardous materials, operations, and equipment. This standard does not purport to address all of the safety problems associated with its use. It is the responsibility of the user of this procedure to establish appropriate safety and health practices and determine the applicability of regulatory limitations prior to use.

#### 2. Referenced Documents

##### 2.1 AASHTO Standards

M 320	Performance-Graded Asphalt Binder
M 323	Superpave Volumetric Mix Design
R 30	Mixture Conditioning of Hot-Mix Asphalt (HMA)
R 35	Superpave Volumetric Design for Hot-Mix Asphalt (HMA)
R 90	Sampling of Aggregates
T 11	Materials Finer Than 75- $\mu$ m (No. 200) Sieve in Mineral Aggregates by Washing
T 27	Sieve Analysis of Fine and Coarse Aggregates
T 84	Specific Gravity and Absorption of Fine Aggregate
T 85	Specific Gravity and Absorption of Coarse Aggregate
T 100	Specific Gravity of Soils
T 166	Bulk Specific Gravity of Compacted Hot Mix Asphalt Using Saturated Surface-Dry Specimens
T 209	Theoretical Maximum Specific Gravity and Density of Hot Mix Asphalt Paving Mixtures
T 228	Specific Gravity of Semi-Solid Bituminous Materials

---

<sup>1</sup>This Standard Operating procedure is based on AASHTO M 323-22

- R 76 Reducing Samples of Aggregate to Testing Size
  - T 275 Bulk Specific Gravity of Compacted Hot Mix Asphalt (HMA) Using Paraffin-Coated Specimens
  - T 283 Resistance of Compacted Asphalt Mixture to Moisture-Induced Damage
  - T 304 Uncompacted Void Content of Fine Aggregate
  - T 312 Preparing and Determining the Density of the Hot-Mix Asphalt (HMA) Specimens by Means of the Superpave Gyrotory Compactor
- 2.2 Asphalt Institute
- 2.3 ASTM Standards
- 2.4 WSDOT Standards
- Construction Manual M 41-01*
  - Standard Specifications M 41-10*
  - Materials Manual M 46-01*
  - SOP 731 Method for Determining Volumetric Properties of Hot-Mix Asphalt (HMA)
  - R 90 WSDOT Errata to FOP for AASHTO Sampling Aggregate Products
  - T 27/11 WSDOT FOP for WAQTC/AASHTO for Sieve Analysis of Fine and Coarse Aggregates
  - T 113 Method of Test for Determination of Degradation Value
  - T 166 WSDOT FOP for AASHTO for Bulk Specific Gravity of Compacted Hot Mix Asphalt Using Saturated Surface-Dry Specimens
  - T 176 WSDOT FOP for AASHTO for Plastic Fines in Graded Aggregates and Soils by Use of the Sand Equivalent Test
  - T 209 WSDOT FOP for AASHTO for Method of Test for Maximum Specific Gravity of Hot Mix Asphalt Paving Mixtures "Rice Density"
  - R 76 WSDOT FOP for AASHTO for Reducing Samples of Aggregates to Testing Size
  - T 304 WSDOT Test Method for AASHTO T 304 Uncompacted Void Content of Fine Aggregate
  - T 312 WSDOT FOP for AASHTO for Preparing and Determining the Density of Hot-Mix Asphalt (HMA) Specimens by Means of the Superpave Gyrotory Compactor
  - T 335 WSDOT FOP for AASHTO T 335 Determining the Percentage of Fracture in Coarse Aggregate
  - T 324 WSDOT FOP for AASHTO T324 Hamburg Wheel-Track Testing of Compacted Asphalt Mixtures
- 2.5 WAQTC Standards
- TM 14 Laboratory Prepared Asphalt Mixture Specimens

### 3. Terminology

3.1 **HMA** – Hot-mix asphalt.

3.2 **Design ESALs** – Design equivalent (80kN) single-axle loads.

3.2.1 Discussion – Design ESALs are the anticipated project traffic level expected on the design lane over a 15-year period. For pavements designed for more or less than 15 years, determine the design ESALs for 15 years when using this standard.

3.3 **Air voids ( $V_a$ )** – The total volume of the small pockets of air between the coated aggregate particles throughout a compacted paving mixture, expressed as a percent of the bulk volume of the compacted paving mixture (Note 1).

**Note 1:** Term defined in *Asphalt Institute Manual MS-2, Mix Design Methods for Asphalt Concrete and Other Hot-Mix Types*.

3.4 **Voids in the mineral aggregate (VMA)** – The volume of the intergranular void space between the aggregate particles of a compacted paving mixture that includes the air voids ( $V_a$ ), and the effective binder content ( $P_{be}$ ), expressed as a percent of the total volume of the specimen (Note 1).

3.5 **Absorbed binder volume ( $V_{ba}$ )** – The volume of binder absorbed into the aggregate (equal to the difference in aggregate volume when calculated with the bulk specific gravity and effective specific gravity).

3.6 **Binder content ( $P_b$ )** – The percent by mass of binder in the total mixture including binder and aggregate.

3.7 **Effective binder volume ( $V_{be}$ )** – The volume of binder which is not absorbed into the aggregate.

3.8 **Voids filled with asphalt (VFA)** – The percentage of the voids in the mineral aggregate (VMA) filled with binder (the effective binder volume divided by the VMA).

3.9 **Dust/Asphalt Ratio ( $P_{200}/P_{be}$ )** – By mass, ratio between percent passing the No. 200 (0.075 mm) sieve ( $P_{200}$ ) and the effective binder content ( $P_{be}$ ).

3.10 **Nominal maximum aggregate size** – For aggregate, the nominal maximum size, (NMS) is the largest standard sieve opening listed in the applicable specification, upon which any material is permitted to be retained. For concrete aggregate, NMS is the smallest standard sieve opening through which the entire amount of aggregate is permitted to pass.

**WSDOT Note 1:** For an aggregate specification having a generally unrestrictive gradation (i.e., wide range of permissible upper sizes), where the source consistently fully passes a screen substantially smaller than the maximum specified size, the nominal maximum size, for the purpose of defining sampling and test specimen size requirements may be adjusted to the screen, found by experience to retain no more than 5% of the materials.

3.11 **Maximum aggregate size** – One size larger than the nominal maximum aggregate size (Note 2).

**Note 2:** The definitions given in sections 3.10 and 3.11 apply to Superpave mixes only and differ from the definitions published in other AASHTO standards.

3.12 **Reclaimed asphalt pavement (RAP)** – Removed and/or processed pavement materials containing asphalt binder and aggregate.

3.13  $N_{\text{initial}}$ ,  $N_{\text{design}}$ ,  $N_{\text{maximum}}$  – the number of gyrations defined in WSDOT *Standard Specification* 9-03.8(2).

3.14 **Effective Asphalt Content ( $P_{be}$ )** – The total asphalt content of a paving mixture minus the portion of asphalt that is lost by absorption into the aggregate particles (Note 1).

#### 4. Summary of the Practice

4.1 **Materials Selection** – Binder and aggregate and RAP stockpiles are selected that meet the environmental and traffic requirements applicable to the paving project. The bulk specific gravity of all aggregates proposed for blending and the specific gravity of the binder are determined.

**Note 3:** If RAP is used, the bulk specific gravity of the RAP aggregate may be estimated by determining the theoretical maximum specific gravity ( $G_{mm}$ ) of the RAP mixture and using an assumed asphalt absorption for the RAP aggregate to back-calculate the RAP aggregate bulk specific gravity, if the absorption can be estimated with confidence. The RAP aggregate effective specific gravity may be used in lieu of the bulk specific gravity at the discretion of the Agency. The use of the effective specific gravity may introduce an error into the combined aggregate bulk specific gravity and subsequent VMA calculations. The Agency may choose to specify adjustments to the VMA requirements to account for this error based on experience with their local aggregates.

4.2 **Design Aggregate Structure** – It is recommended at least three trial aggregate blend gradations from selected aggregate stockpiles are blended. For each trial gradation, an initial trial binder content is determined, and at least two specimens are compacted in accordance with WSDOT FOP for AASHTO T 312. A design aggregate structure and an estimated design binder content are selected on the basis of satisfactory conformance of a trial gradation meeting the requirements given in Section 9-03.8(2) of the *Standard Specifications for Road, Bridge, and Municipal Construction (Standard Specifications)* for  $V_a$ , VMA, VFA, Dust/Asphalt Ratio at  $N_{\text{design}}$ , and relative density at  $N_{\text{initial}}$ .

**Note 4:** Previous Superpave mix design experience with specific aggregate blends may eliminate the need for three trial blends.



- 4.3 **Design Binder Content Selection** – Replicate specimens are compacted in accordance with WSDOT FOP for AASHTO T 312 at the estimated design binder content and at the estimated design binder content  $\pm 0.5\%$ . The design binder content is selected on the basis of satisfactory conformance with the requirements of Section 9-03.8(2) of the *Standard Specifications* for  $V_a$ , VMA, VFA, and Dust/Asphalt Ratio ( $P_{200}/P_{be}$ ) at  $N_{des}$ , and the relative density at  $N_{ini}$  and  $N_{max}$ . For WSDOT projects, the design binder content selection is determined by the Contractor and is verified by the WSDOT.
- 4.4 **Evaluating Moisture Susceptibility** – The moisture susceptibility of the design aggregate structure is evaluated at the design binder content: compacted to  $7.0 \pm 1.0\%$  air voids in accordance with WSDOT FOP for AASHTO T 312, and evaluated for stripping inflection point according to WSDOT FOP for AASHTO T324 Hamburg Wheel-Track Testing of Compacted Asphalt Mixtures. The design shall meet the stripping inflection point requirement of WSDOT Standard Specification 9-03.8(2). The WSDOT State Materials Laboratory will evaluate the HMA for moisture susceptibility.

## 5. Significance and Use

- 5.1 The procedure described in this practice is used to produce HMA which satisfies Superpave HMA volumetric mix design requirements.

## 6. Preparing Aggregate Trial Blend Gradations

- 6.1 The asphalt binder grade will be indicated in WSDOT Contract Plans.
- 6.2 Determine the specific gravity of the binder according to T 228.
- 6.3 Obtain samples of aggregates proposed to be used for the project from the aggregate stockpiles in accordance with WSDOT Errata to FOP for AASHTO R 90.

**Note 5:** Each stockpile usually contains a given size of an aggregate fraction. Most projects employ three to five stockpiles to generate a combined gradation conforming to the job-mix formula and Section 9-03.8(6) of the *Standard Specifications*.

- 6.4 Reduce the samples of aggregate fractions according to WSDOT FOP for AASHTO R 76 to samples of the size specified in WAQTC TM 14 Laboratory Prepared Asphalt Mixture Specimens - Aggregate Preparation.
- 6.5 Wash and grade each aggregate sample according to WAQTC TM 14 Laboratory Prepared Asphalt Mixture Specimens - Aggregate Preparation.
- 6.6 Determine the bulk and apparent specific gravity for each coarse and fine aggregate fraction in accordance with T 85 and T 84, respectively, and determine the specific gravity of the mineral filler in accordance with T 100. WSDOT requires specific gravity determinations to be reported to an accuracy of 0.001.

## 6.7 Blend the aggregate fractions using Equation 1:

$$P = Aa + Bb + Cc, \text{ etc.} \quad (1)$$

Where:

- $P$  = Percentage of material passing a given sieve for the combined aggregates A, B, C, etc.
- A, B, C, etc. = Percentage of material passing a given sieve for aggregates A, B, C, etc.
- a, b, c, etc. = proportions of aggregates A, B, C, etc. used in the combination, and where the total = 1.00.

- 6.8 Prepare a minimum of three trial aggregate blend gradations; plot the gradation of each trial blend on a 0.45-power gradation analysis chart, and confirm that each trial blend meets the Aggregate Gradation Control Points in Section 9-03.8(6) of the *Standard Specifications*. Gradation control is based on four control sieve sizes: the sieve for the maximum aggregate size, the sieve for the nominal maximum aggregate size, the No. 4 or No. 8 (4.75- or 2.36 mm) sieve, and the No. 200 (0.075 mm) sieve. For WSDOT projects, gradation shall be determined by the following sieves as defined in table W1T. An example of three acceptable trial blends in the form of a gradation plot is given in Figure 1.

**Table W1T**

Sieves Required for Gradation Determination				
Sieve Size	$\frac{3}{8}$ in	$\frac{1}{2}$ in	$\frac{3}{4}$ in	1 in
1 1/2"				X
1"			X	X
3/4"		X	X	X
1/2"	X	X	X	X
3/8"	X	X	X	X
No. 4	X	X	X	X
No. 8	X	X	X	X
No. 16	X	X	X	X
No. 30	X	X	X	X
No. 50	X	X	X	X
No. 100	X	X	X	X
No. 200	X	X	X	X

X = indicates sieve is required for gradation determination

- 6.9 Obtain a test specimen from each of the trial blends according to WSDOT FOP for AASHTO R 76, and conduct the quality tests specified in Section 9-03.8(2) subsections 1, 2, 3, and 4 of the *Standard Specifications* to confirm that the aggregate in the trial blends meets the minimum quality requirements specified in Section 9-03.8(2) of the *Standard Specifications*.

**Note 6:** The designer has an option of performing the quality tests on each stockpile instead of the trial aggregate blend. The test results from each stockpile can be used to estimate the results for a given combination of materials.

**Figure 1 Evaluation of the Gradations of Three Trial Blends (Example)**

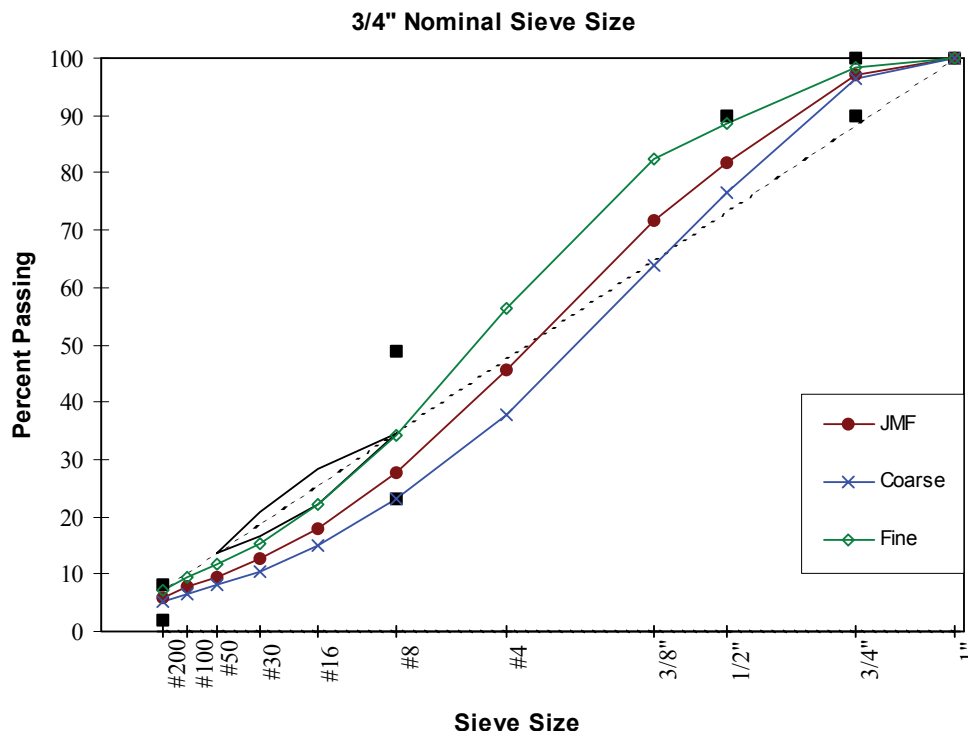

## 7. Determining an Initial Trial Binder Content for Each Trial Aggregate Gradation

7.1 Designers can either use their experience with the materials or the procedure given in Appendix A1 to determine an initial trial binder content for each trial aggregate blend gradation.

**Note 7:** When using RAP, the initial trial asphalt content should be reduced by an amount equal to that provided by the RAP.

## 8. Compacting Specimens of Each Trial Gradation

8.1 Prepare replicate mixtures (Note 8) at the initial trial binder content for each of the chosen trial aggregate trial blend gradations. From Table 1, determine the number of gyrations based on the design ESALs for the project. On WSDOT projects the ESAL level will be indicated in the Contract Special Provisions.

**Note 8:** At least two replicate specimens are required, but three or more may be prepared if desired. Generally, 4500 to 4700 g of aggregate is sufficient for each compacted specimen with a height of 110 to 120 mm for aggregates with combined bulk specific gravities of 2.550 to 2.700, respectively.

- 8.2 Condition the mixtures according to R 30, and compact the specimens to  $N_{design}$  gyrations in accordance with WSDOT FOP for AASHTO T 312. Record the specimen height to the nearest 0.1 mm after each revolution.
- 8.3 Determine the bulk specific gravity ( $G_{mb}$ ) of each of the compacted specimens in accordance with WSDOT FOP for AASHTO T 166 or T 275 as appropriate. The bulk specific gravity results of the replicate specimens shall not differ by more than 0.020.

**Table 1 Superpave Gyrotory Compaction Effort**

Design ESALs <sup>a</sup> (million)	Compaction Parameters			Typical Roadway Application <sup>b</sup>
	$N_{initial}$	$N_{design}$	$N_{max}$	
< 0.3	6	50	75	Applications include roadways with very light traffic volumes such as local roads, county roads, and city streets where truck traffic is prohibited or at a very minimal level. Traffic on these roadways would be considered local in nature, not regional, intrastate, or interstate. Special purpose roadways serving recreational sites or areas may also be applicable to this level.
0.3 to < 3	7	75	115	Applications include many collector roads or access streets. Medium-trafficked city streets and the majority of county roadways may be applicable to this level.
3 to < 30	8	100	160	Applications include many two-lane, multilane, divided, and partially or completely controlled access roadways. Among these are medium to highly trafficked city streets, many state routes, U.S. highways, and some rural Interstates.
≥ 30	9	125	205	Applications include the vast majority of the U.S. Interstate system, both rural and urban in nature. Special applications such as truck-weighing stations or truck-climbing lanes on two-lane roadways may also be applicable to this level.

<sup>a</sup>The anticipated project traffic level expected on the design lane over a 15-year period. Regardless of the actual design life of the roadway, determine the design ESALs for 15 years.

<sup>b</sup>As defined by *A Policy on Geometric Design of Highways and Streets, 2001*, AASHTO.

- 8.4 Determine the theoretical maximum specific gravity ( $G_{mm}$ ) according to WSDOT FOP for AASHTO T 209 of separate samples representing each of these combinations that have been mixed and conditioned to the same extent as the compacted specimens.

**Note 11:** The maximum specific gravity for each trial mixture shall be based on the average of at least two tests. The maximum specific gravity results of the replicate specimens shall not differ by more than 0.011.

## 9. Evaluating Compacted Trial Mixtures

9.1 Determine the volumetric requirements for the trial mixtures in accordance with Section 9-03.8(2) of the *Standard Specifications*.

9.2 Calculate  $V_a$  and VMA at  $N_{\text{design}}$  for each trial mixture using equations 2 and 3:

$$V_a = 100 \times \left( 1 - \left( \frac{G_{mb}}{G_{mm}} \right) \right) \quad (2)$$

$$VMA = 100 - \left( \frac{G_{mb} P_s}{G_{sb}} \right) \quad (3)$$

Where:

- $G_{mb}$  = Bulk specific gravity of the extruded specimen
- $G_{mm}$  = Theoretical maximum specific gravity of the mixture
- $P_s$  = Percent of aggregate in the mixture (100- $P_b$ )
- $G_{sb}$  = Bulk specific gravity of the combined aggregate

**Note 12:** Although the initial trial binder content was estimated for a design air void content of 4.0%, the actual air void content of the compacted specimen is unlikely to be exactly 4.0%. Therefore, the change in binder content needed to obtain a 4.0% air void content, and the change in VMA caused by this change in binder content, is estimated. These calculations permit the evaluation of VMA and VFA of each trial aggregate gradation at the same design air void content, 4.0%.

9.3 Estimate the volumetric properties at 4.0 percent air voids for each compacted specimen. On WSDOT projects, the gyration level will be specified in the Contract Provisions.

9.3.1 Determine the difference in average air void content at  $N_{\text{design}}$  ( $\Delta V_a$ ) of each aggregate trial blend from the design level of 4.0% using Equation 4:

$$\Delta V_a = 4.0 - V_a \quad (4)$$

9.3.2 Estimate the change in binder content ( $\Delta P_b$ ) needed to change the air void content to 4.0% using Equation 5:

$$\Delta P_b = -0.4 (\Delta V_a) \quad (5)$$

9.3.3 Estimate the change in VMA ( $\Delta VMA$ ) caused by the change in the air void content ( $\Delta V_a$ ) determined in Section 9.3.1 for each trial aggregate blend gradation, using Equations 6 or 7.

$$\Delta VMA = 0.2(\Delta V_a) \text{ if } V_a > 4.0 \quad (6)$$

$$\Delta VMA = -0.1(\Delta V_a) \text{ if } V_a < 4.0 \quad (7)$$

**Note 13:** A change in binder content affects the VMA through a change in the bulk specific gravity of the compacted specimen ( $G_{mb}$ ).

- 9.3.4 Calculate the VMA for each aggregate trial blend at  $N_{design}$  gyrations and 4.0% air voids using Equation 8:

$$VMA_{design} = VMA_{trial} + \Delta VMA \quad (8)$$

Where:

- $VMA_{design}$  = VMA estimated at a design air void content of 4.0%  
 $VMA_{trial}$  = VMA determined at the initial trial binder content

- 9.3.5 Using the values of  $\Delta V_a$  determined in Section 9.3.1 and Equation 9, estimate the relative density of each specimen at  $N_{initial}$  when the design air void content is adjusted to 4.0 percent at  $N_{design}$ :

$$\%G_{mm_{initial}} = 100 \times \left( \frac{G_{mb}h_d}{G_{mm}h_i} \right) - \Delta V_a \quad (9)$$

Where:

- $\%G_{mm_{initial}}$  = relative density at  $N_{initial}$  gyrations at the adjusted design binder content  
 $h_d$  = Height of the specimen after  $N_{design}$  gyrations, from the Superpave gyratory compactor, *mm*  
 $h_i$  = Height of the specimen after  $N_{initial}$  gyrations, from the Superpave gyratory compactor, *mm*

- 9.3.6 Estimate the percent of effective binder ( $P_{be}$ ) and calculate the Dust/Asphalt Ratio ( $P_{200}/P_{be}$ ) for each trial blend using Equations 10 and 11:

$$P_{be_{est}} = -(P_s \times G_b) \frac{(G_{se} - G_{sb})}{(G_{se} \times G_{sb})} + P_{be_{est}} \quad (10)$$

Where:

- $P_{be_{est}}$  = Estimated effective binder content  
 $P_s$  = Percent of aggregate in the mixture (100- $P_b$ )  
 $G_b$  = Specific gravity of the binder  
 $G_{se}$  = Effective specific gravity of the aggregate  
 $G_{sb}$  = Bulk specific gravity of the combined aggregate  
 $P_{be_{est}}$  = Estimated binder content

$$\text{Dust/Asphalt Ratio} = \frac{P_{200}}{P_{be}} \quad (11)$$

Where:

- $P_{200}$  = Percent passing the No. 200 (0.075 mm) sieve

- 9.3.7 Compare the estimated volumetric properties from each trial aggregate blend gradation at the adjusted design binder content with the criteria specified in Section 9-03.8(2) of the *Standard Specifications*. Choose the trial aggregate blend gradation that best satisfies the volumetric criteria.

**Note 14:** Table 2 presents an example of the selection of a design aggregate structure from three trial aggregate blend gradations.

**Note 15:** Many trial aggregate blend gradations will fail the VMA criterion. Generally, the % criterion will be met if the VMA criterion is satisfied. Section 12.1 gives a procedure for the adjustment of VMA.

**Note 16:** If the trial aggregate gradations have been chosen to cover the entire range of the gradation controls, then the only remaining solution is to make adjustments to the aggregate production or to introduce aggregates from a new source. The aggregates that fail to meet the required criteria will not produce a quality mix and should not be used. One or more of the aggregate stockpiles should be replaced with another material which produces a stronger structure. For example, a quarry stone can replace a crushed gravel, or crushed fines can replace natural fines.

**Table 2 Selection of a Design Aggregate Structure (Example)**

Volumetric Property	Trial Mixture (¾ Inch Nominal Maximum Aggregate) 15 Year Project Design ESALs = 5 million			Criteria
	1	2	3	
	At the Initial Trial Binder Content			
$P_b$ (trial)	4.4	4.4	4.4	
$\%G_{mm_{initial}}$ (trial)	88.1	87.8	87.1	
$\%G_{mm_{design}}$ (trial)	95.9	95.3	94.7	
$V_a$ at $N_{design}$	4.1	4.7	5.3	4.0
VMA <sub>trial</sub>	12.9	13.4	13.9	
Adjustments to Reach Design Binder Content ( $V_a = 4.0\%$ at $N_{design}$ )				
$\Delta V_a$	-0.1	-0.7	-1.3	
$\Delta P_b$	0.0	0.3	0.5	
$\Delta VMA$	0.0	-0.1	-0.3	
At the Estimated Design Binder Content ( $V_a = 4.0\%$ at $N_{design}$ )				
Estimated $P_b$ (design)	4.4	4.7	4.9	
VMA (design)	12.9	13.3	13.6	$\geq 13.0$
$\%G_{mm_{initial}}$ (design)	88.2	89.5	88.4	$\leq 89.0$

**Notes:**

- The top portion of this table presents measured densities and volumetric properties for specimens prepared for each aggregate trial blend at the initial trial binder content.
- None of the specimens had an air void content of exactly 4.0 percent. Therefore, the procedures described in Section 9 must be applied to:
  - estimate the design binder content at which  $TV_a = 4.0$  percent, and
  - obtain adjusted VMA and relative density values at this estimated binder content.
- The middle portion of this table presents the change in binder content ( $\Delta P_b$ ) and VMA ( $\Delta VMA$ ) that occurs when the target air void content ( $TV_a$ ) is adjusted to 4.0 percent for each trial aggregate blend gradation.
- A comparison of the VMA and densities at the estimated design binder content to the criteria in the last column shows that trial aggregate blend gradation No. 1 does not have sufficient VMA (12.9% versus a requirement of  $\geq 13.0\%$ ). Trial blend No. 2 exceeds the criterion for relative density at  $N_{initial}$  gyrations (89.5% versus requirement of  $\leq 89.0\%$ ). Trial No. 3 meets the requirement for relative density and VMA and, in this example, is selected as the design aggregate structure.

**10. Selecting the Design Binder Content**

- Prepare replicate mixtures (Note 8) containing the selected design aggregate structure at each of the following three binder contents: (1) the estimated design binder content,  $P_{b(design)}$ ; (2) 0.5% below  $P_{b(design)}$ ; and (3) 0.5% above  $P_{b(design)}$ .

10.1.1 Use the number of gyrations previously determined in Section 8.1.

- Condition the mixtures according to R 30, and compact the specimens to  $N_{design}$  gyrations according to WSDOT FOP for AASHTO T 312. Record the specimen height to the nearest 0.1 mm after each revolution.



- 10.3 Determine the bulk specific gravity of each of the compacted specimens in accordance with WSDOT FOP for AASHTO T 166 or AASHTO T 275 as appropriate.
- 10.4 Determine the theoretical maximum specific gravity ( $G_{mm}$ ) according to WSDOT FOP for AASHTO T 209 of each of the three mixtures using companion samples which have been conditioned to the same extent as the compacted specimens (Note 8).
- 10.5 Determine the design binder content which produces a target air void content of 4.0 percent at  $N_{design}$  gyrations using the following steps:

- 10.5.1 Calculate  $V_a$ , VMA, and VFA at  $N_{design}$  using Equations 2, 3 and 12: The volumetric properties are determined for each specimen and then averaged for each replicate mixture.

$$VFA = 100 \times \left( \frac{VMA - V_a}{VMA} \right) \quad (12)$$

- 10.5.2 Calculate the Dust/Asphalt Ratio, using Equation 13.

$$\text{Dust/Asphalt Ratio} = \frac{P_{200}}{P_{be}} \quad (13)$$

Where:

$P_{be}$  = Effective binder content

- 10.5.3 For each of the three mixtures, determine the average corrected specimen relative densities at  $N_{initial}$  (%), using Equation 14.

$$\%G_{mm_{initial}} = 100 \times \left( \frac{G_{mb}h_d}{G_{mm}h_i} \right) \quad (14)$$

- 10.5.4 Plot the average  $V_a$ , VMA, VFA, and relative density at  $N_{design}$  for replicate specimens versus binder content.

**Note 17:** All plots are generated automatically by the Superpave software. Figure 2 presents a sample data set and the associated plots.

- 10.5.5 By graphical or mathematical interpolation (Figure 2), determine the binder content to the nearest 0.1 percent at which the target  $V_a$  is equal to 4.0 percent. This is the design binder content ( $P_b$ ) at  $N_{design}$ .

- 10.5.6 By interpolation (Figure 2), verify that the volumetric requirements specified in Section 9-03.8(2) of the *Standard Specifications* are met at the design binder content.

- 10.6 Compare the calculated percent of maximum relative density with the design criteria at  $N_{initial}$  by interpolation, if necessary. This interpolation can be accomplished by the following procedure.

- 10.6.1 Prepare a densification curve for each mixture by plotting the measured relative density at  $x$  gyrations,  $\%G_{mm_x}$ , versus the logarithm of the number of gyrations (see Figure 3).

- 10.6.2 Examine a plot of air void content versus binder content. Determine the difference in air voids between 4.0 percent and the air void content at the nearest, lower binder content. Determine the air void content at the nearest, lower binder content at its data point, not on the line of best fit. Designate the difference in air void content as  $\Delta V_a$ .
- 10.6.3 Using Equation 14, determine the average corrected specimen relative densities at  $N_{\text{initial}}$ . Confirm that satisfies the design requirements in Section 9-03.8(2) of the *Standard Specifications* at the design binder content.
- 10.7 Prepare replicate (Note 8) specimens composed of the design aggregate structure at the design binder content to confirm that  $\%G_{mm_{\text{max}}}$  satisfies the design requirements in Section 9-03.8(2) of the *Standard Specifications*.
- 10.7.1 Condition the mixtures according to R-30, and compact the specimens according to WSDOT FOP for AASHTO T312 to the maximum number of gyrations,  $N_{\text{max}}$ , from Section 9-03.8(2) of the *Standard Specifications*.
- 10.7.2 Determine the average specimen relative density at  $N_{\text{max}}$ ,  $\%G_{mm_{\text{max}}}$ , by using Equation 15, and confirm that satisfies the volumetric requirement in Section 9-03.8(2) of the *Standard Specifications*.

$$\%G_{mm_{\text{max}}} = 100 \times \frac{G_{mb}}{G_{mm}} \quad (15)$$

Where:

$\%G_{mm_{\text{max}}}$  = Relative density at  $N_{\text{max}}$  gyrations at the design binder content

**Figure 2 Sample Volumetric Design Data at  $N_{\text{des}}$**

$P_b$ (%)	$V_a$ (%)	VMA (%)	VFA (%)	Maximum Density at $N_{\text{design}}$ ( $G_{mm}$ )	Density at $N_{\text{design}}$ lbs/ft <sup>3</sup>
4.3	9.9	17.0	41.8	2.660	165.6
4.8	8.2	16.7	50.9	2.636	164.1
5.3	6.9	16.6	58.5	2.617	162.9
5.8	5.2	16.5	68.5	2.585	160.9
6.3	3.9	16.2	76.0	2.574	160.2

In this example, the estimated design binder content is 4.8 percent; the minimum VMA requirement for the design aggregate structure ( $\%$  in nominal maximum size) is 13.0 percent, and the VFA requirements is 65 to 78 percent.

Entering the plot of percent air voids versus percent binder content at 4.0 percent air voids, the design binder content is determined as 6.2 percent.

Entering the plots of percent VMA versus percent binder content and percent VFA versus percent binder content at 6.2 percent binder content, the mix meets the VMA and VFA requirement.

Figure 3 Sample Densification Curve

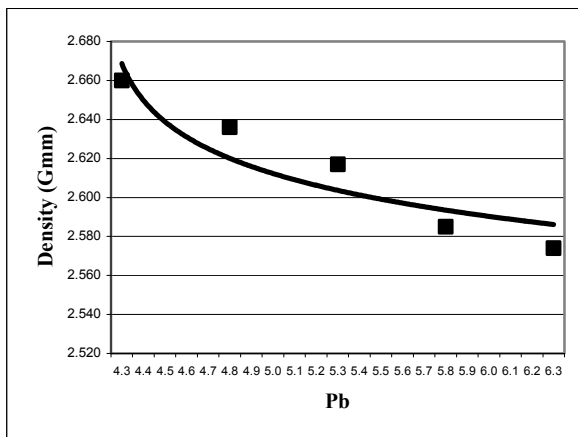
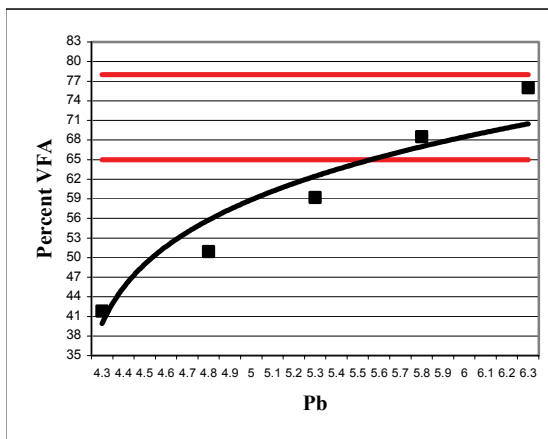
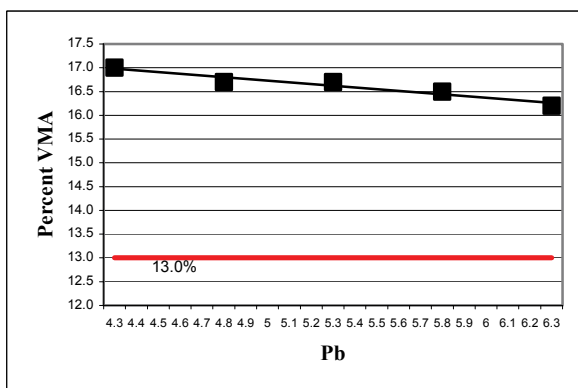
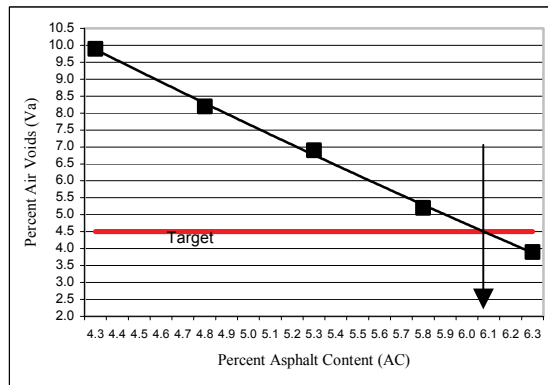
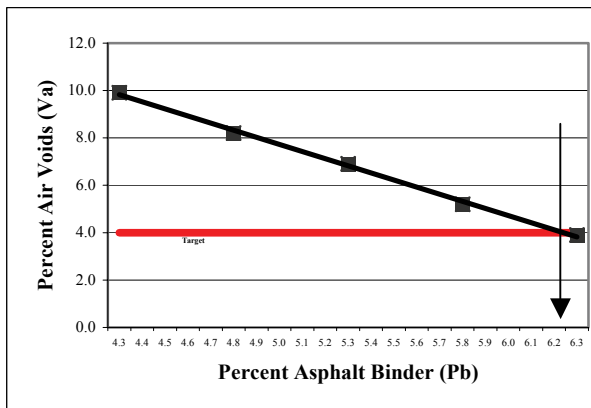
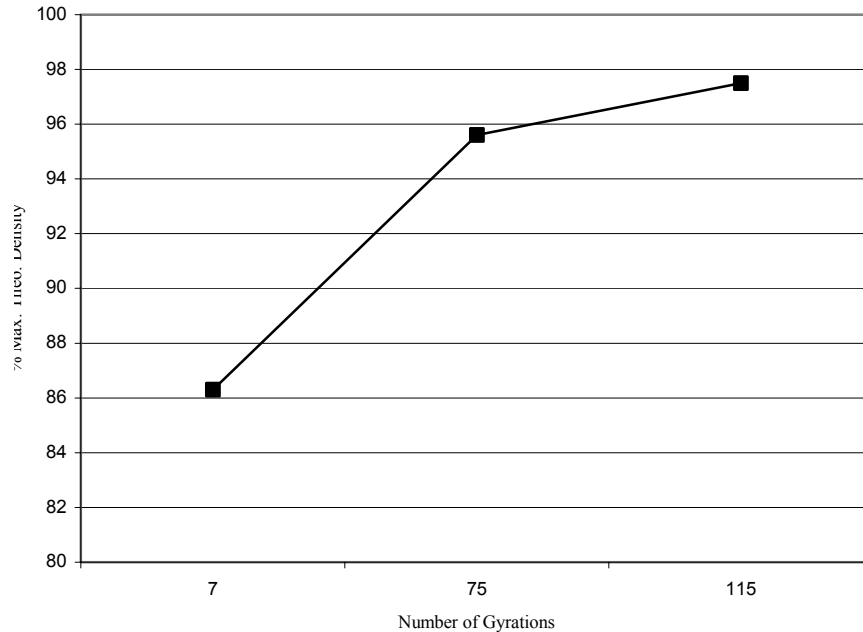

Figure 4



## 11. Evaluating Moisture Susceptibility

- 11.1 Prepare two mixture specimens composed of the design aggregate structure at the design binder content. Prepare the specimens according to WAQTC TM 14 Laboratory Prepared Asphalt Mixture Specimens, and compact the specimens to  $7.0 \pm 1.0\%$  air voids in accordance to WSDOT FOP for AASHTO T 312.
- 11.2 The WSDOT State Materials Laboratory will evaluate the HMA for moisture susceptibility by determining the stripping inflection point in accordance with WSDOT FOP for AASHTO T324 Hamburg Wheel-Track Testing of Compacted Asphalt Mixtures and meets WSDOT Standard Specification 9-03.8(2).

## 12. Adjusting the Mixture to Meet Properties

- 12.1 Adjusting VMA – If a change in the design aggregate skeleton is required to meet the specified VMA, there are three likely options: (1) change the gradation (Note 18); (2) reduce the minus No. 200 (0.075 mm) fraction (Note 19); or (3) change the surface texture and/or shape of one or more of the aggregate fractions (Note 20).

**Note 18:** Changing gradation may not be an option if the trial aggregate blend gradation analysis includes the full spectrum of the gradation control area.

**Note 19:** Reducing the percent passing the No. 200 (0.075 mm) sieve of the mix will typically increase the VMA. If the percent passing the No. 200 (0.075 mm) sieve is already low, this is not a viable option.

**Note 20:** This option will require further processing of existing materials or a change in aggregate sources.

- 12.2 Adjusting VFA – The lower limit of the VFA range should always be met at 4.0% air voids if the VMA meets the requirements. If the upper limit of the VFA is exceeded, then the VMA is substantially above the minimum required. If so, redesign the mixture to reduce the VMA. Actions to consider for redesign include: (1) changing to a gradation that is closer to the maximum density line; (2) increasing the minus No. 200 (0.075 mm) fraction, if room is available within the specification control points; or (3) changing the surface texture and shape of the aggregates by incorporating material with better packing characteristics, e.g., less thin, elongated aggregate particles.

### 13. Report

- 13.1 The report shall include the identification of the project number, mix class designation, and mix design number.
- 13.2 The report shall include information on the design aggregate structure including the source of aggregate, and gradation, including the blending ratios.
- 13.3 The report shall contain information about the design binder including the source of binder and the performance grade.
- 13.4 The report shall contain information about the HMA including the percent of binder in the mix; the relative density; the number of initial, design, and maximum gyrations; and the VMA, VFA,  $V_a$ , and Dust/Asphalt Ratio  $P_{be}$ ,  $G_{mm}$ ,  $G_{mb}$ ,  $G_{sb}$  and  $G_{se}$  of the aggregate blend,  $G_{sb}$  of the fine aggregate, and  $G_b$ .
- 13.5 The report shall contain the results of the moisture susceptibility testing and the required level of anti-strip additive needed.

### 14. Keywords

- 14.1 HMA mix design; Superpave; volumetric mix design.

## Appendix

### A1. Calculating an Initial Trial Binder Content for Each Aggregate Trial Blend

#### Nonmandatory Information

A1.1 Calculate the bulk and apparent specific gravities of the combined aggregate in each trial blend using the specific gravity data for the aggregate fractions obtained in Section 6.6 and Equations 16 and 17:

$$G_{sb} = \frac{P_1 + P_2 + \dots + P_n}{\frac{P_1}{G_1} + \frac{P_2}{G_2} + \dots + \frac{P_n}{G_n}} \quad (16)$$

$$G_{sa} = \frac{P_1 + P_2 + \dots + P_n}{\frac{P_1}{G_1} + \frac{P_2}{G_2} + \dots + \frac{P_n}{G_n}} \quad (17)$$

Where:

$G_{sb}$  = Bulk specific gravity for the combined aggregate

$G_{sa}$  = Apparent specific gravity for the combined aggregate

$P_1, P_2, P_n$  = Percentages by mass of aggregates 1, 2, n

$G_1, G_2, G_n$  = Bulk specific gravities (Equation 16) or apparent specific gravities (Equation 17) of aggregates 1, 2, n.

A1.2 Estimate the effective specific gravity of the combined aggregate in the aggregate trial blend using Equation 18:

$$G_{se} = G_{sb} + 0.8(G_{sa} - G_{sb}) \quad (18)$$

Where:

$G_{se}$  = Effective specific gravity of the combined aggregate

$G_{sb}$  = Bulk specific gravity of the combined aggregate

$G_{sa}$  = Apparent specific gravity of the combined aggregate

**Note 21:** The multiplier, 0.8, can be changed at the discretion of the designer. Absorptive aggregates may require values closer to 0.6 or 0.5.

**Note 22:** The Superpave mix design system includes a mixture conditioning step before the compaction of all specimens; this conditioning generally permits binder absorption to proceed to completion. Therefore, the effective specific gravity of Superpave mixtures will tend to be close to the apparent specific gravity in contrast to other design methods where the effective specific gravity generally will lie near the midpoint between the bulk and apparent specific gravities.

A1.3 Estimate the volume of binder absorbed into the aggregate,  $V_{ba}$ , using Equations 19 and 20:

$$V_{ba} = W_s \left( \frac{1}{G_{sb}} - \frac{1}{G_{se}} \right) \quad (19)$$

Where:

$W_s$  = The mass of aggregate in 1 cm<sup>3</sup> of mix, g, is calculated as

$$W_s = \frac{P_s(1 - V_a)}{\frac{P_b}{G_b} + \frac{P_s}{G_{se}}} \quad (20)$$

and Where:

$P_b$  = Percent of binder, in decimal equivalent, assumed to be 0.05

$P_s$  = Percent of aggregate in mixture, in decimal equivalent, assumed to be 0.95

$G_b$  = Specific gravity of the binder

$V_a$  = Volume of air voids, assumed to be 0.04 cm<sup>3</sup> in 1 cm<sup>3</sup> of mix

**Note 23:** This estimate calculates the volume of binder absorbed into the aggregate,  $V_{ba}$ , and subsequently, the initial, trial binder content at a target air void content of 4.0%.

A1.4 Estimate the volume of effective binder using Equation 21:

$$V_{be} = 0.176 - (0.0675 \log (S_n)) \quad (21)$$

Where:

$V_{be}$  = Volume of effective binder, cm<sup>3</sup>

$S_n$  = Nominal maximum sieve size of the largest aggregate in the aggregate trial blend, mm.

**Note 24:** This regression Equation is derived from an empirical relationship between:

(1) VMA and  $V_{be}$  when the air void content,  $V_a$ , is equal to 4.0 percent:  $V_{be} = \text{VMA} - V_a = \text{VMA} - 4.0$ ; and (2) the relationship between VMA and the nominal maximum sieve size of the aggregate in MP 2. For WSDOT projects, see contract provisions.

A1.5 Calculate the estimated initial trial binder ( $P_{bi}$ ) content for the aggregate trial blend gradation using Equation 22:

$$P_{bi} = 100 \times \left( \frac{G_b(V_{be} + V_{ba})}{(G_b(V_{be} + V_{ba})) + W_s} \right) \quad (22)$$

Where:

$P_{bi}$  = Estimated initial trial binder content, percent by weight of total mix







## **WSDOT SOP 733**

### ***Determination of Pavement Density Differentials Using the Nuclear Density Gauge***

#### **1. Scope**

This test method describes the procedure for locating and testing areas of suspected low cyclic density. Lower pavement density has been related to temperature differentials and areas of “spots, streaks” or visual pavement irregularities. This method uses infrared detection devices and visual inspection to identify areas of potentially low cyclic density.

#### **2. Definitions**

- a. Temperature Differential Area- Any area where the temperature of the newly placed HMA pavement is greater than 25° F different than the surrounding area.
- b. Aggregate segregation- “Spots, streaks” or visual pavement irregularities in the newly placed HMA pavement that has a significant difference in texture when compared to the surrounding material.
- c. Systematic Density Testing - the testing of temperature differential areas or areas of aggregate segregation to determine if there is a pattern of low cyclic density.

#### **3. Equipment**

- a. An approved infrared camera OR a handheld noncontact infrared thermometer (features for both should include continuous reading, minimum, maximum, and average readings, laser sighting, and a minimum distance to spot size ratio (D:S) of 30:1.
- b. Nuclear moisture-density gauge.
- c. Tape measure.
- d. A can of spray paint for marking test locations.
- e. Required report form.

#### **4. Testing Criteria**

- a. Where temperature differentials are 25° F or greater a systematic HMA compaction test is required.
- b. Where temperature differentials are less than 25° F a systematic HMA compaction test is not required unless, an area shows signs of visual pavement irregularities, surface segregation or a significantly different texture.

#### **5. Determination of Systematic Density Testing Locations**

Use either an infrared camera or a handheld non-contact infrared device to locate temperature differential areas as follows:

## 5.1 Infrared Camera

- a. Delineate a 500 ft section of pavement and systematically check the area for temperature differentials within one minute of HMA placement and prior to any compaction of the pavement.
- b. No temperature profiles shall be performed within the first or last 25 tons of production each day or within 25 feet of any transverse joint.
- c. Focus the camera on the freshly placed HMA pavement prior to compaction. Adjust the camera to show the high and low temperatures.
- d. Viewing should occur from the side of the paved lane approximately 15 to 20 feet back from the paver looking toward the paver.
- e. The “spot” function on the camera should be used to obtain the temperature of the cool area and the surrounding HMA to assess for temperature differentials.
- f. If the temperature differential is 25° F or more, locate the approximate center of the temperature differential area with the camera. The offset is from the center of the temperature differential area to the edge of the lane. Mark the location to be tested for systematic HMA compaction by placing a paint mark at the edge of the lane corresponding to the center of the temperature differential. Record the HMA surface temperature, temperature differential, offset, and station on DOT form 350-170 and in the MATS database.
- g. If the temperature differential is less than 25° F, there is no need to mark the location unless an area within the paved lane has a significantly different texture.

If testing is performed because of a significantly different textured area, locate the center of the affected area and mark the location as described in step g and as shown in Figure 1 with an (S) after the temperature differential.

## 5.2 Handheld Noncontact Infrared Device

- a. Delineate a 500 ft section of pavement and systematically check the area for temperature differentials within one minute of HMA placement and prior to any compaction of the pavement.
- b. No temperature profiles shall be performed within the first or last 25 tons of production each day or within 25 feet of any transverse joint.
- c. Perform a longitudinal scan of the pavement by standing at the edge of the paving lane about 5 to 10 feet back from the paver. Scan the mat with the handheld noncontact thermometer continuously in a longitudinal manner by walking behind the paver in the direction of paving, staying the same distance away from the paver for 500 ft of HMA placement.
- d. The offset for the longitudinal profile should be anywhere from 18 inches from the edge to no more than half the width of the paved lane. (The need to vary the longitudinal offset will be necessary to get an accurate representation of the whole mat.) Scanning temperatures for the other half of the paved lane should be performed from the other side.

**Note:** Typically, temperature differentials or surface segregation can be captured with the longitudinal scan.

- e. Perform a transverse scan after completion of the longitudinal scan, making sure to scan the entire width of the paved lane excluding the outer 18 inches on each side. It should be performed approximately 5 to 10 feet behind the paver (to check for streaking of the mat).  
*Note:* Typically, streaking caused by temperature differentials or surface segregation will be captured by the transverse scan.
- f. If the temperature differential is 25° F or more, locate the approximate center of the temperature differential area by scanning that specified location. The offset is from the center of the temperature differential area to the edge of the paved lane. Mark the location to be tested for systematic density testing by placing a paint mark at the edge of the lane corresponding to the center of the temperature differential. Record the HMA surface temperature, temperature differential, offset, and station on DOT form 350-170 or in the MATS database.
- g. If the temperature differential is less than 25° F, there is no need to mark the location unless an area within the paved lane has visual pavement irregularities, surface segregation or a significantly different texture. If testing is performed because of a significantly different textured area, locate the center of the affected area and mark the location as described in step g and as shown in Figure 1 with an (S) after the temperature differential.

## 6. Systematic Density Testing Procedure

- a. Systematic density testing shall begin after finish rolling is completed.
- b. All systematic density testing shall be performed in accordance with WSDOT FOP for WAQTC T 355.
- c. Systematic density testing shall be performed at all the locations recorded in 5.1f and 5.2f of this procedure. Gauge probe shall be placed at the station and offset determined above as the center of the temperature differential area.
- e. If any temperature differentials are found in the initial assessment of the paving operations, at least one temperature profile shall be taken for every subsequent 500 ft of paving operation.
- d. If no temperature differentials or streaks greater than 25° F are found or if there are no more than 2 density readings lower than 90 percent found in a 500 ft section, the testing frequency may be reduced. Random checks however, should continue to be made throughout the day and the results recorded.
- e. If any significant equipment or weather changes occur, temperature profiles should be performed to determine if the new operation is capable of producing uniform HMA temperatures.
- f. If it is found that the paving machine is creating areas that are significantly different in texture from the surrounding pavement, systematic density tests should be performed to determine if these are areas of low cyclic density.

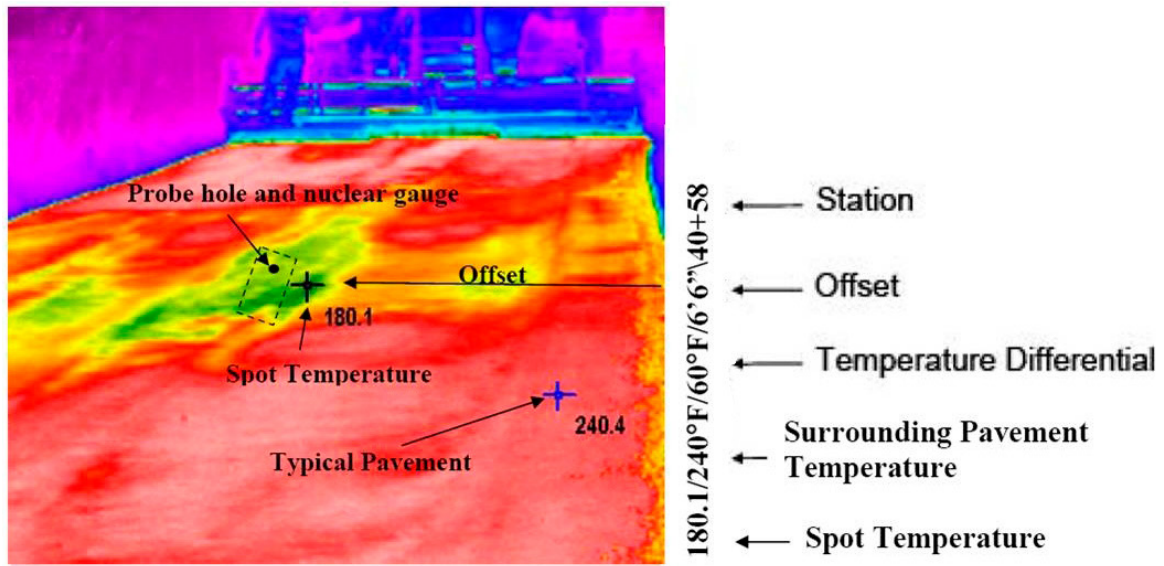

Marking Location of Temperature Differential  
Figure 1



---

---

## WSDOT SOP 734

### *Sampling Hot Mix Asphalt After Compaction (Obtaining Cores)*

#### 1. Scope

- This method describes the process for obtaining Hot Mix Asphalt test cores for Laboratory testing after compaction has been completed. Cores may range in size from 2 in to 12 in

#### 2. Significance and Use

- Samples obtained in accordance with the procedure given in this practice may be used for measuring pavement thickness, density, and acceptance testing.
- When cores are used to determine nuclear gauge correlation, refer to WSDOT SOP 730.
- When cores are used to determine pavement density, the Bulk Specific Gravity ( $G_{mb}$ ) is determined according to WSDOT FOP for AASHTO T 166.
- When cores are used for forensic testing of HMA, refer to SOP 737 “Procedure for the Forensic Testing of HMA Field Cores” to determine the required number and size of cores.

#### 3. Apparatus

- Core Drill Machine –A Core Drill Machine of sufficient horsepower and depth to minimize distortion of the compacted cores of Hot Mix Asphalt.
- Core Bit – The cutting edge of the core drill bit shall be of hardened steel or other suitable material with diamond chips embedded in the metal cutting edge or as recommended by the core drill bit manufacturer. Typically the core drill bit should have an inside diameter of  $4'' \pm 0.25''$  (100 mm  $\pm$  6 mm) or  $6'' \pm 0.25''$  (150 mm  $\pm$  6 mm), these core bit dimensions are agency preferred alternatives. Suitable larger and smaller diameter core bit alternatives shall be employed as required by the agency.
- Tools – Core layers may be separated using a saw or other suitable device which provides a clean smooth surface and does not damage the core.
- Retrieval Device (Optional) –The retrieval device used for removing core samples from holes must preserve the integrity of the core. The device may be a steel rod of suitable length and with a diameter that will fit into the space between the core and the pavement material. There may be a 90 degree bend at the top to form a handle and a 90 degree bend at the bottom, approximately 2 in (50 mm) long, forming a hook to assist in the retrieval of the core or other suitable device.

#### 4. Safety

This standard does not purport to address all of the safety concerns, associated with its use. It is the responsibility of the user of this standard operating procedure to establish a pre activity safety plan prior to use.

## 5. Test Site Location

- The quantity of cores to be obtained shall be determined by the test procedure to be performed or agency requirements. Refer to WSDOT SOP 730 when taking correlation cores.
- Determine the location of the core(s) as required by the agency.

## 6. Procedure

- For freshly placed Hot Mix Asphalt materials, the core shall be taken when the material has had sufficient amount of time to cool to prevent damage to the core.
- Pavement may be cooled to expedite the removal of the core by the following methods; water, ice water, ice, or dry ice or liquid nitrogen.
- Place the coring machine and core bit over the selected location.
- Keep the core bit perpendicular to the Hot Mix Asphalt surface during the coring process.  
**Note 1:** If any portion of the coring machine shifts during the operation, the core may break or distort.
- Constant downward pressure should be applied on the core bit. Failure to apply constant pressure, or too much pressure, may cause the bit to bind or distort the core.
- Continue the coring operation until the desired depth is achieved.
- If necessary, use a retrieval device to remove the core.
- Clearly identify the cores location and offset without causing damage (i.e., lumber crayon or grease pencil).  
**Note 2:** If the core is damaged to a point that it cannot be used for its intended purpose, a new core shall be obtained within 6 in of the original location.

## 7. Filling Core Holes

- When necessary, the hole made from the coring operation shall be filled with a material that will not separate from the surrounding material. If Hot Mix Asphalt is available and used, it shall be compacted into the hole. A **ready mix concrete or fast set grout** product may be used in lieu of a Hot Mix Asphalt. A black dye can be used to color the grout on **driving surface**.
- **Prior to backfilling a core hole on a bridge deck, ensure that the hole and sidewalls are dry enough to bond with the sealant before applying.**
- **Acceptable sealants include; asphalt binder or any waterproof sealant designed for asphalt applications as stated by the manufacturer.**
- **Apply sealant to bottom surface and side walls of core hole as needed.**
- **Backfill the core hole with Hot Mix Asphalt, cold mix asphalt, ready mix concrete or grout and compact as needed.**

## 8. Transporting Cores

- Transport cores in a suitable container(s) that prevents damage from jarring, rolling, hitting together, and/or impact with any object.
- Prevent cores from freezing or excessive heat above 130° F (54° C), during transport.

**Note 1:** In extreme ambient temperature conditions, cores should be placed in water during transport.

- If the core is damaged in transport to a point it can not be utilized for its intended purpose the core will not be used.

## 9. Separate The Layers

- When necessary, separate the lifts or layers of pavement courses by using a water cooled saw to cut the core on the designated lift line or separate by other suitable methods that will not damage the lifts or layers to be tested.

**Note 4:** Lift lines are often more visible by rolling the core on a flat surface and/or surface drying the core.

## 10. Length Determination

Measure the thickness of the designated lift to the nearest 0.01' or 1/8" according to WSDOT Test Method 720.

## 11. Report

Core information shall be reported on standard agency forms and should include the following information.

- The date the cores were obtained
- Paving date
- Contract number
- Project title
- Location of test
- The lift being evaluated
- Type of material being evaluated
- Mix Design Lab Number
- Average thickness of each core (to the nearest 0.01' or 1/8 ")
- Average Theoretical Maximum Density

**This page intentionally left blank.**





## WSDOT SOP 735

### *Standard Operating Procedure for Longitudinal Joint Density*

#### 1. General Scope

- a. This procedure describes the method for determining the location of a longitudinal joint density test.
- b. Longitudinal joint density tests are performed in addition to Quality Assurance (QA) density tests.
- c. One longitudinal joint density test will be performed on the confined or unconfined edge at each longitudinal joint.

#### 2. Longitudinal Joint Testing

- a. The longitudinal joint density test will be conducted in accordance with WSDOT FOP for WAQTC T 355, except “Test Site Location, Section 1, subsection c, which is modified by this procedure to read “No closer than 18 in (450mm) to any vertical mass, or less than 6 in (152 mm) from a vertical pavement edge,” making sure the gauge will sit flush with the hot-mix asphalt (HMA). See Figure 1.
- b. A longitudinal joint density will be required on the lane edge side of a shoulder if the shoulder is required to meet the same QA density requirements as the traveled lane.

*Note:* Hot lap joints are not included in longitudinal joint testing.

#### 3. Number of Longitudinal Joint Tests

- a. For projects requiring 400 tons subplot with 5 sublots – One reading, at each longitudinal joint to be tested, will be taken within each compaction lot at the same station location as the third subplot.
- b. For projects requiring 80 ton sublots – One reading, at each longitudinal joint to be tested, will be taken every four hundred tons or at every fifth subplot tested.

#### 4. Calculation of Results

- a. Calculate the Longitudinal Joint density in accordance WSDOT SOP 729.

#### 5. Report

- a. Report the results using one or more of the following:
  - Materials Testing System (MATS)
  - WSDOT [Form 350-095](#)
  - Form approved in writing by the State Materials Engineer

*Note:* Lot Number corresponds to the lot where the set of longitudinal joint readings were taken. The station corresponds to the station within the lot (i.e., third subplot) where the set of longitudinal joint readings were taken.

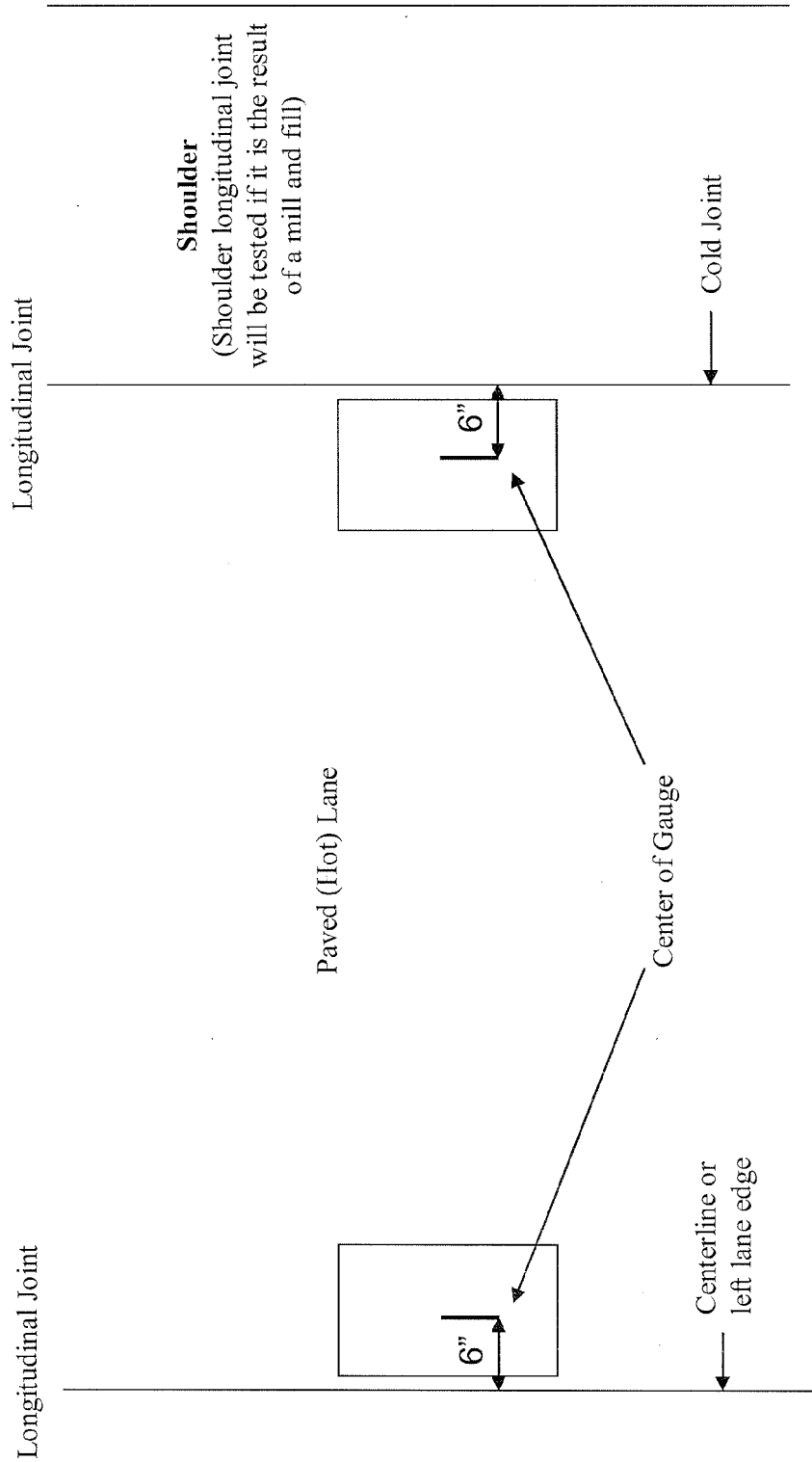

Longitudinal Joint Testing Locations  
Figure 1

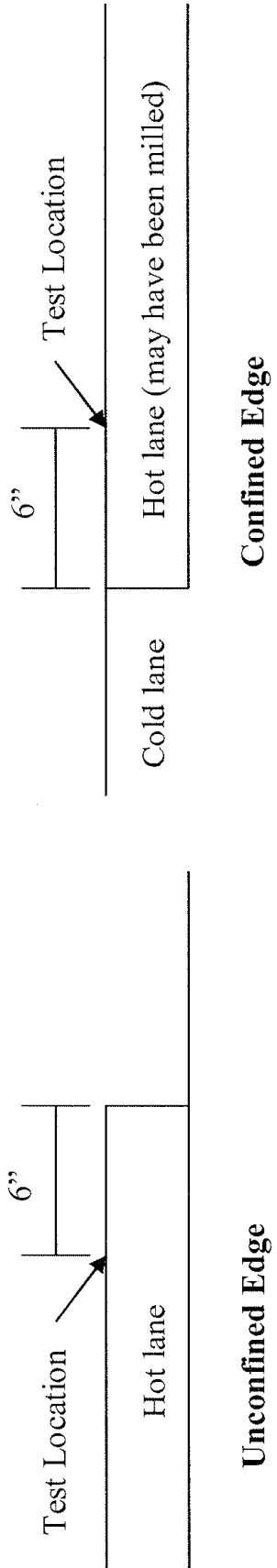

Longitudinal Test Location Examples  
Figure 2





## WSDOT SOP 736

### *In-Place Density of Bituminous Mixes Using Cores*

#### 1. Scope

This test method describes the procedure for determining the relative density of bituminous mixes by means of roadway cores.

#### 2. Procedure

Cores for densities will be taken in accordance with WSDOT SOP 734 Sampling Hot Mix Asphalt After Compaction (Obtaining Core)

The bulk specific gravity ( $G_{mb}$ ) of the core will be determined in accordance with WSDOT FOP for T 166 Bulk Specific Gravity of Compacted Hot Mix Asphalt (HMA) Using Saturate Surface-Dry Specimens.

The Theoretical maximum density of the mix will be determined in accordance with WSDOT FOP for AASHTO T 209 Theoretical Maximum Specific Gravity and Density of Hot-Mix Asphalt Paving Mixtures.

Determine the average theoretical maximum density in accordance with WSDOT SOP 729 Determination of the Moving Average of Theoretical Maximum Density (TMD) for HMA

#### 3. Calculation of Percent of Compaction

The percent compaction is determined by comparing the density of the roadway core to the theoretical maximum density.

Calculate core density to the nearest 0.1 pcf as follows:

$$\text{Core Density} = G_{mb} \times 62.245 \text{ pcf}$$

Calculate percent compact (round to the nearest 0.1 percent) as follows:

$$\text{Percent Compaction} = (\text{Core Density}) / (\text{Average Theoretical Maximum Density}) \times 100$$





## WSDOT SOP 737

### *Procedure for the Forensic Testing of HMA Field Cores*

#### 1. Scope

This method describes the process for testing Hot Mix Asphalt (HMA) field cores for asphalt content, gradation, volumetric analysis, Hamburg Wheel-Test, Indirect Tensile Strength and asphalt binder grade determination.

1.1 This standard covers the procedural steps required for forensic testing of HMA field cores. Cores for forensic testing may range in size from 4-12 inches, although many specific test procedures require the core specimen to be six inches.

1.2 The values stated in English units are to be regarded as the standard.

#### 2. Significance And Use

2.1 Approvals of the material for HMA are required prior to use per *Standard Specifications* Section 1-06.1.

2.2 Samples obtained in accordance with this procedure, shall be obtained using WSDOT SOP 734, "Sampling Hot Mix Asphalt after Compaction (Obtaining Cores)".

#### 3. Reference Documents

Refer to applicable test methods within this procedure.

#### 4. Apparatus

Refer to applicable test methods within this procedure.

#### 5. Safety

This standard does not purport to address all of the safety concerns, associated with its use.

It is the responsibility of the user of this standard operating procedure to establish a pre activity safety plan prior to use.

#### 6. Test Site Location

The sample location and quantity of cores to be obtained shall be determined by the test procedure to be performed or agency requirements.

## 7. Procedures

Perform procedures as needed to obtain desired test results:

### 7.1 Obtain cores per WSDOT SOP 734, “Sampling Hot Mix Asphalt after Compaction”.

The required quantity and size of cores for each procedure shall be as shown in Table 1:

Procedure	Size	Number of Cores	Special Instructions
AASHTO T331, “Standard Method of Test for Bulk Specific Gravity (Gmb) Density of Compacted Hot Mix Asphalt (HMA) Using Automatic Vacuum Sealing Method”	4” or 6”	1	
WSDOT FOP for AASHTO T209, “Theoretical Maximum Specific Gravity Density of Hot Mix Asphalt Paving Mixtures”	4” or 6”	1	
WSDOT FOP for AASHTO T308, “Determining the Asphalt Binder Content of Hot Mix Asphalt by the Ignition Method”	6”	1	
WSDOT FOP for AASHTO T27/11, “Mechanical Analysis of Extracted Aggregate”	6”	1	
WSDOT FOP for AASHTO T324, “Hamburg Wheel-Track Testing of Compacted Hot Mix Asphalt”	6”	2	Obtain cores 6” apart for each determination
WSDOT FOP for ASTM D 6931, “Standard Test Method for Indirect Tensile Strength of Bituminous Mixtures”	6”	3	Obtain cores 6” apart for each determination
AASHTO R29, “Standard Practice for Grading or Verifying the Performance Grade (PG) of an Asphalt Binder”	6”	2	Obtain cores 6” apart for each determination

**Table 1**

### 7.2 Remove moisture from cores per AASHTO R 79, “Vacuum Drying Compacted Asphalt Specimens”.

### 7.3 Determine core density per AASHTO T331, “Standard Method of Test for Bulk Specific Gravity (Gmb) and Density of Compacted Hot Mix Asphalt (HMA) Using Automatic Vacuum Sealing Method”, and WSDOT FOP for AASHTO T209, “Theoretical Maximum Specific Gravity and Density of Hot Mix Asphalt Paving Mixtures”. Theoretical Maximum Specific Gravity and Density of Hot Mix Asphalt Paving Mixtures data from corresponding field testing may be substituted in lieu of testing core material.

**Note 1:** AASHTO T331 shall be performed prior to WSDOT FOP for AASHTO T 209. Before performing T 209 all shaved or bare aggregate surfaces either from coring, surface wear or handling of the specimen shall be removed and separated from the specimen by carefully picking them from the specimen using a sharp tipped tool. Care must be taken not to remove fully coated aggregate. Removed particles shall be discarded and not included with the WSDOT FOP for AASHTO T209 test specimen.



- 7.4 Determine asphalt content per WSDOT FOP for AASHTO T308, “Determining the Asphalt Binder Content of Hot Mix Asphalt by the Ignition Method”, if an ignition furnace correction factor (IFCF) is available. Otherwise, perform AASHTO T 164, “Standard Method of Test for Quantitative Extraction of Asphalt Binder from Hot Mix Asphalt”.
- 7.5 Determine aggregate sieve analysis per WSDOT FOP for AASHTO T 27/11, “Mechanical Analysis of Extracted Aggregate”. WSDOT FOP for AASHTO T27/11 shall be performed following binder extraction per WSDOT FOP for AASHTO T 308, “Determining the Asphalt Binder Content of Hot Mix Asphalt by the Ignition Method” or AASHTO T164, “Standard Method of Test for Quantitative Extraction of Asphalt Binder from Hot Mix Asphalt”.
- 7.6 Determine rutting and moisture-susceptibility of HMA per WSDOT FOP for AASHTO T324, “Hamburg Wheel-Track Testing of Compacted Hot Mix Asphalt”.
- 7.7 Determine Indirect Tensile Strength (IDT) per WSDOT FOP for ASTM D6931, “Standard Test Method for Indirect Tensile Strength of Bituminous Mixtures”.
- 7.8 Determine grade of asphalt per AASHTO R29, “Standard Practice for Grading or Verifying the Performance Grade (PG) of an Asphalt Binder”. Extract the binder in accordance with AASHTO R59, “Recovery of Asphalt Binder from Solution by Abson Method” or ASTM D1856, “Standard Test Method for Recovery of Asphalt from Solution by Abson Method”, for each asphalt grade determination.

**Note 2:** Binder specimens for AASHTO R29, Standard Practice for Grading or Verifying the Performance Grade (PG) of an Asphalt Binder may be obtained in conjunction with AASHTO T164, Standard Method of Test for Quantitative Extraction of Asphalt Binder from Hot Mix Asphalt.





---

## WSDOT SOP 738

### *Establishing Maximum Field Density for Recycled Concrete Aggregates by Test Point Evaluation*

#### 1. Scope

- 1.1 This test method describes the procedure for determining the maximum test point density that can be achieved with a controlled group of compaction equipment on a consistent thickness of recycled concrete aggregate. The density of the material will be determined by a nuclear density gauge using either backscatter or thin layer method. Compactive effort will be applied incrementally and density readings taken after each pass of the roller until the point where additional compactive effort ceases to increase the density of the material. Once the maximum density has been achieved, the compactive effort will be recorded and repeated unless one of the parameters changes. Parameters would include: lift thickness, compaction equipment, moisture content, material source or gradation.

#### 2. Referenced Documents

##### 2.1 AASHTO Standards

T 310 In-place Density and Moisture Content of Soil and Soil-aggregate by Nuclear Methods (Shallow Depth)

##### 2.2 WSDOT Standards

M 41 *Standard Specifications*

M 46 *Materials Manual*

#### 3. Significance

- 3.1 A section of roadway or fill is compacted. After each increment or roller pass (a pass is defined as one time being from the start of the test strip to its end) the material is tested for density by the use of the nuclear density gauge. The density is recorded after each increment until the maximum density has been achieved.

#### 4. Apparatus

- 4.1 Equipment and nuclear density/moisture gauge required to perform a moisture/density determination according to AASHTO T 310.
- 4.2 Standardize the gauge according to AASHTO T 310.

#### 5. Test Site Location

- 5.1 At the beginning of placement, choose a uniform section large enough to perform the test point evaluation. The test point evaluation area needs to be representative of the placement area and approximately 100 feet long. Equipment other than that required to compact the material should be kept off the evaluation area during testing.

## 6. Procedure

- 6.1 Test the first lift of material at or near optimum moisture after performing the first pass with the roller or compactor.
- 6.2 Take a one minute reading with the nuclear gauge in the test location.
- 6.3 Record wet density results (lb/ft<sup>3</sup>) for each location of the report form.
- 6.4 Clearly mark the test location (if using paint, do not paint the gauge).
- 6.5 All subsequent density determinations must be in the same location and the same gauge orientation as the first test.
- 6.6 Make another pass with the roller or compactor over the entire test area.
- 6.7 Repeat density reading. Record on report form.
- 6.8 Continue compacting and testing, maintaining moisture content, until the density readings level off or start to drop. This indicates the relative density has reached its maximum with the compaction equipment being used.  
**Note:** A slight decrease in density may be observed before maximum density is achieved. If suspected, examine the material, and if no fracture of the material is visible, continue the rolling/density testing process until maximum density is achieved.
- 6.9 Once the relative density has reached its maximum, the test point evaluation will be considered complete and the compaction method shall be repeated on subsequent aggregate placement and compaction.
- 6.10 Moisture content should be monitored regularly (at least daily) with the use of the nuclear gage to ensure the material is at or near the optimum moisture content. If the moisture content is more than two points below the optimum moisture content the test point evaluation will be considered invalid.

## 7. Report

- Contract number
- Compaction equipment type
- Material type and source
- Lift thickness

DOT Form 350-070, gauge number, , and on the Test Point Evaluation Report Form

## WSDOT Test Method T 802

### *Method of Test for Flexural Strength of Concrete (Using Simple Beam With Center-Point Loading)*

#### 1. Scope

- a. This method is similar to AASHTO T 177 and covers the procedure for determining the flexural strength of concrete by the use of a simple beam with center-point loading.

#### 2. Apparatus

- a. The center-point loading method shall be used in the laboratory. The testing machine shall conform to the requirements of Sections 15, 16, and 17 of the Methods of Verification of Testing Machines (AASHTO T 67). In the field, a manually operated calibrated jack shall be used in conjunction with the field testing machine supplied by the Regional Materials Engineer. The apparatus shall incorporate the following requirements. The load shall be applied at the center point of the span, normal to the loaded surface of the beam, employing bearing blocks designed to ensure that forces applied to the beam will be vertical only and applied without eccentricity. The direction of the reactions shall be parallel to the direction of the applied load at all times during the test. The load shall be applied at a uniform rate and in such a manner as to avoid shock. The edges of the load-applying block and of the supports shall not depart from a plane by more than .002 in (0.051 mm).
- b. Caliper – A 12 in (1300 mm) long caliper accurate to 0.01 in (0.25 mm).

**Figure 1 Diagrammatic View of Apparatus for Flexure Test of Concrete by Center-point Loading Method**

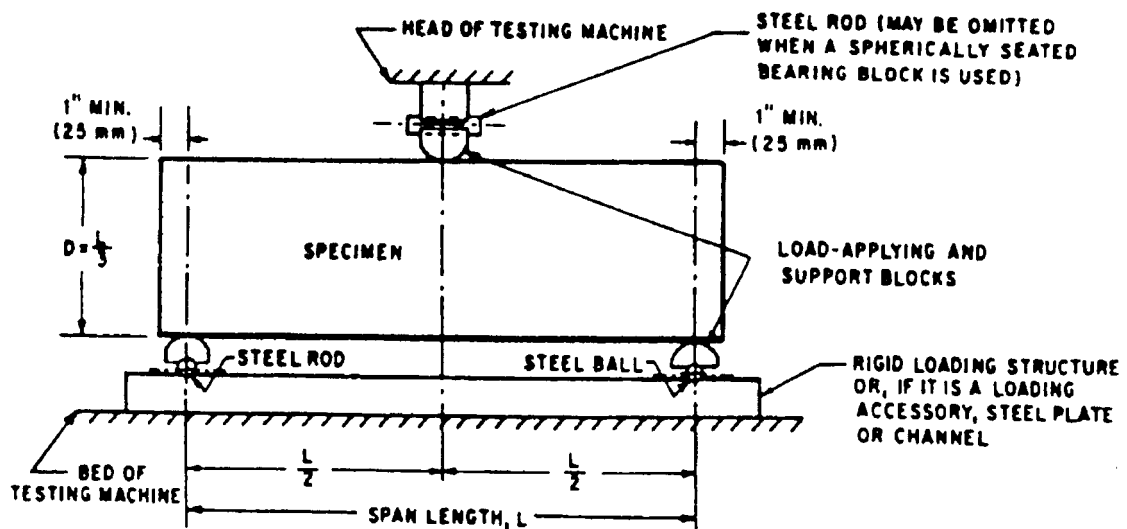

NOTE—Apparatus may be used inverted.

### 3. Test Specimen

As nearly as practicable, the test specimen, as tested, shall have a span three times its depth. The test specimen shall be formed and stored as prescribed in WSDOT Test Method No. 808.

### 4. Procedure

- a. Turn the specimen on its side with respect to its position when molded, and center it on the supporting bearing blocks. The load-applying block shall be brought in contact with the upper surface at the center line between the supports.
- b. Bring load applying block in full contact with the beam surface by applying a 100 lbs (3.1 N) preload. Check to ensure that the beam is in uniform contact with the bearing blocks and the load applying block.
- c. If load is applied with a hand pump, load the beam by applying the load at a rate of one full pump stroke per second. When the applied load is about 4,000 lbs (125 N), reduce the full pump stroke to about a 12-pump stroke and maintain the one second stroke rate. Rate of load application for screw power machines, with the moving head operating at 0.05 in (1.3 mm) per minute when the machine is running idle, is acceptable.

### 5. Measurement of Specimens

- a. Determine the beam dimensions, width (b) and depth (d), by averaging two measurements for width and two measurements for depth. The measurements shall be taken at the failure plane to an accuracy of 0.05 in (1.3 mm).

### 6. Calculation

- a. The modulus of rupture is calculated as follows:

$$R = \frac{3P1}{2bd^2}$$

Where:

- R = Modulus of rupture in psi or MPa
- P = Maximum applied load indicated by the testing machine in lb•f or N
- l = Span length in inches or mm
- b = Average width of specimen in inches or mm
- d = Average depth of specimen in inches or mm

### 7. Report

- a. The report shall include the following:
  - (1) Identification number,
  - (2) Average width,
  - (3) Average depth,
  - (4) Span length in inches or mm,
  - (5) Maximum applied load in lb•f or N,
  - (6) Modulus of rupture calculated to the nearest 5 psi (0.03MPa),
  - (7) Defects in specimen, and
  - (8) Age of specimen.
- b. All test results will be reported on DOT Form 350-042.

## Performance Exam Checklist

### WSDOT Test Method T 802

**Method of Test for Flexural Strength of Concrete  
(Using Simple Beam With Center-Point Loading)**

Participant Name: \_\_\_\_\_ Exam Date: \_\_\_\_\_

Record the symbols "P" for passing or "F" for failing on each step of the checklist.

**Procedure Element**

**Preparation**

**Trial 1    Trial 2**

- |   |       |       |
|---|-------|-------|
| 1. Copy of current procedure available at test site?  | _____ | _____ |
| 2. In the field, Jack properly calibrated?  | _____ | _____ |
| 3. Beam turned on its side with respect to its position when molded, and centered on the supporting bearing blocks?                     | _____ | _____ |
| 4. Load applying block brought into contact with the beam at the center line between the supports?                                      | _____ | _____ |
| 5. 100 lbs (3.1 N) preload applied and the beam then checked to ensure uniform contact with the bearing blocks and load applying block? | _____ | _____ |
| 6. Load applied to the beam at the proper uniform rate?   | _____ | _____ |

**Equipment**

- |   |       |       |
|---|-------|-------|
| 1. Where required are calibration/verifications tags present on equipment used in this procedure? | _____ | _____ |
| 2. All equipment functions according to the requirements of this procedure?                       | _____ | _____ |

Comments:    First Attempt: Pass \_\_\_\_\_ Fail \_\_\_\_\_    Second Attempt: Pass \_\_\_\_\_ Fail \_\_\_\_\_

Examiner Signature: \_\_\_\_\_    WAQTC #: \_\_\_\_\_





# WSDOT FOP for C 805<sup>1</sup>

## ***Rebound Hammer Determination of Compressive Strength of Hardened Concrete***

### **1. Scope**

- 1.1 This test method covers the determination of a rebound number of hardened concrete using a spring-driven steel hammer.
- 1.2 The values stated in inch-pound units are to be regarded as the standard.
- 1.3 This standard does not purport to address all of the safety concerns, if any, associated with its use. It is the responsibility of the user of this standard to establish appropriate safety and health practices and determine the applicability of regulatory limitations prior to use.

### **2. Referenced Documents**

#### 2.1 ASTM Standards

- |       |  |
|-------|--|
| C 125 | Terminology Relating to Concrete and Concrete Aggregates   |
| C 670 | Practice for Preparing Precision and Bias Statements for Test Methods for Construction Materials |
| E 18  | Test Methods for Rockwell and Rockwell Superficial Hardness of Metallic Materials                |

### **3. Significance and Use**

- 3.1 This test method is not intended as the basis for acceptance or rejection of concrete because of the inherent uncertainty in the estimated strength.

### **4. Apparatus**

- 4.1 **Rebound Hammer** – Consisting of a spring-loaded steel hammer that when released strikes a steel plunger in contact with the concrete surface. The spring-loaded hammer must travel with a consistent and reproducible velocity. The rebound distance of the steel hammer from the steel plunger is measured on a linear scale attached to the frame of the instrument.  
**Note 1:** Use type N rebound hammers that are commercially available to accommodate testing of various sizes and types of concrete construction.
- 4.2 **Abrasive Stone** – Consisting of medium-grain texture silicon carbide or equivalent material.
- 4.3 **Test Anvil** – Approximately 150 mm (6 in) diameter by 150 mm (6 in) high cylinder made of tool steel with an impact area hardened to  $66 \pm 2$  HRC as measured by test method ASTM E 18. An instrument guide is provided to center the rebound hammer over the impact area and keep the instrument perpendicular to the surface.

---

<sup>1</sup>This FOP is based on ASTM C 805 and has been modified per WSDOT standards. To view the redline modifications, contact the WSDOT Quality Systems Manager at 360-709-5412.

- 4.4 **Verification** – Rebound hammers shall be serviced and verified annually and whenever there is reason to question their proper operation. Verify the functional operation of a rebound hammer using the test anvil described in [Section 4.3](#). During verification, support the test anvil on a bare concrete floor or slab. The manufacturer shall report the rebound number to be obtained by a properly operating instrument when tested on an anvil of specified hardness.

**Note 2:** Typically, a rebound hammer will result in a rebound number of  $80 \pm 2$  when tested on the anvil described in [Section 4.3](#). The test anvil needs to be supported on a rigid base to obtain reliable rebound numbers. Verification on the test anvil does not guarantee that the hammer will yield repeatable data at other points on the scale. The hammer can be verified at lower rebound numbers by using blocks of polished stone having uniform hardness. Some users compare several hammers on concrete or stone surfaces encompassing the usual range of rebound numbers encountered in the field.

## 5. Test Area and Interferences

- 5.1 **Selection of Test Surface** – Concrete members to be tested shall be at least 100 mm (4 in) thick and fixed within a structure. Smaller specimens must be rigidly supported. Avoid areas exhibiting honeycombing, scaling, or high porosity. Do not compare test results if the form material against which the concrete was placed is not similar. Troweled surfaces generally exhibit higher rebound numbers than screeded or formed finishes. If possible, test structural slabs from the underside to avoid finished surfaces.

- 5.2 **Preparation of Test Surface** – A test area shall be at least 150 mm (6 in) in diameter. Heavily textured, soft, or surfaces with loose mortar shall be ground flat with the abrasive stone described in [Section 4.2](#). Smooth-formed or troweled surfaces do not have to be ground prior to testing. Do not compare results from ground and unground surfaces.

- 5.3 Do not test frozen concrete.

**Note 3:** Moist concrete at  $0^{\circ}\text{C}$  ( $32^{\circ}\text{F}$ ) or less may exhibit high rebound values. Concrete should be tested only after it has thawed. The temperatures of the rebound hammer itself may affect the rebound number. Rebound hammers at  $-18^{\circ}\text{C}$  ( $0^{\circ}\text{F}$ ) may exhibit rebound numbers reduced by as much as two or three units (1 unit = 1 whole number).

- 5.4 For readings to be compared, the direction of impact, horizontal, downward, upward, or at another angle, must be the same or established correction factors shall be applied to the readings.

- 5.5 Do not conduct tests directly over reinforcing bars with cover less than 0.75 in (20 mm).

**Note 4:** The location of reinforcement may be established using reinforcement locators or metal detectors. Follow the manufacturer's instructions for proper operation of such devices.

## 6. Procedure

- 6.1 Hold the instrument firmly so that the plunger is perpendicular to the test surface. Gradually push the instrument toward the test surface until the hammer impacts. After impact, maintain pressure on the instrument and, if necessary, depress the button on the side of the instrument to lock the plunger in its retracted position. Read the rebound number on the scale to the nearest whole number and record the rebound number. Take ten readings from each test area. No two impact tests shall be closer together than 25 mm (1 in). Examine the impression made on the surface after impact, and if the impact crushes or breaks through a near-surface air void, disregard the reading and take another reading.

## 7. Calculation

- 7.1 Discard readings differing from the average of ten readings by more than six units and determine the average of the remaining readings. If more than two readings differ from the average by six units, discard the entire set of readings and determine rebound numbers at ten new locations within the test area.

## 8. Report

- 8.1 Report the following information for each test area:
- 8.1.1 Date and time of testing.
  - 8.1.2 Identification of location tested in the concrete construction and the type and size of member tested.
    - 8.1.2.1 Description of the concrete mixture proportions including type of coarse aggregates if known.
    - 8.1.2.2 Design strength of concrete tested.
  - 8.1.3 Description of the test area including:
    - 8.1.3.1 Surface characteristics (trowelled, screeded) of area.
    - 8.1.3.2 If surface was ground and depth of grinding.
    - 8.1.3.3 Type of form material used for test area.
    - 8.1.3.4 Curing conditions of test area.
    - 8.1.3.5 Type of exposure to the environment.
  - 8.1.4 Hammer identification and serial number.
    - 8.1.4.1 Air temperature at the time of testing.
    - 8.1.4.2 Orientation of hammer during test.
  - 8.1.5 Average rebound number for test area.
    - 8.1.5.1 Remarks regarding discarded readings of test data or any unusual conditions.

## 10. Precision and Bias

See ASTM C 805 precision and bias.



# Performance Exam Checklist

## FOP for ASTM C 805

### *Rebound Hammer Determination of Compressive Strength of Hardened Concrete*

Participant Name: \_\_\_\_\_ Exam Date: \_\_\_\_\_

Record the symbols "P" for passing or "F" for failing on each step of the checklist.

#### Procedure Element

##### *Preparation*

**Trial 1** **Trial 2**

- |  |       |       |
|--|-------|-------|
| 1. Copy of current procedure available at test site?       | _____ | _____ |
| 2. Hammer properly serviced and calibrated or verified?    | _____ | _____ |
| 3. Test location properly prepared?                        | _____ | _____ |
| 4. Test location meets minimum size requirement?           | _____ | _____ |
| 5. Ten acceptable readings taken in each test area?        | _____ | _____ |
| 6. Readings properly spaced in test area?                  | _____ | _____ |
| 7. Test readings properly converted to estimated strength? | _____ | _____ |
| 8. Test information properly recorded?                     | _____ | _____ |
| 9. All calculations performed correctly?                   | _____ | _____ |

#### Equipment

- |   |       |       |
|---|-------|-------|
| 10. Are calibration/verifications tags present on equipment used in this procedure? | _____ | _____ |
| 11. All equipment functions according to the requirements of this procedure?        | _____ | _____ |

Comments: First Attempt: Pass \_\_\_\_\_ Fail \_\_\_\_\_ Second Attempt: Pass \_\_\_\_\_ Fail \_\_\_\_\_

Examiner Signature: \_\_\_\_\_ WAQTC #: \_\_\_\_\_





## WSDOT Test Method T 807

### *Method of Operation of California Profilograph and Evaluation of Profiles*

#### 1. Scope

- a. The operation of the California Profilograph, the procedure used for determining the Profile Index from profilograms of pavements made with the Profilograph, and the procedure used to locate individual high points in excess of 0.3 in are described in Parts I, II, and III, respectively, in this test method.

#### Part I

#### Operation of the California Profilograph

#### 2. Procedure

- a. Equipment – The California Profilograph consists of a frame 25 LF long supported upon multiple wheels at either end arranged in a staggered pattern, such that no two wheels cross the same bump at the same time. The profile is recorded from the vertical movement of a wheel attached to the frame at midpoint and is in reference to the mean elevation of the 12 points of contact with the road surface established by the support wheels (see [Figure 1](#)). The profilogram is recorded on a scale of 1 in = 25 LF longitudinally and the actual change in elevation vertically. Motive power is provided manually.
- b. Operation – The instructions for assembling the Profilograph are contained in a booklet accompanying each unit. Particular attention should be paid to the listed precautions.

In operation, the Profilograph should be moved at a speed no greater than a walk so as to eliminate as much bounce as possible. Too high a speed will result in a profilogram that is difficult to evaluate.

Calibration of the Profilograph should be checked periodically. The horizontal scale can be checked by running a known distance and scaling the result on the profilogram. If the scale is off, the profile wheel should be changed to one of a proper diameter. The vertical scale is checked by putting a board of known thickness under the profile wheel and again scaling the result on the profilogram. If the scale is off, the cause of the incorrect height should be determined and corrected.

#### 3. Procedure

- a. Equipment – To determine the Profile Index, use a plastic scale 1.70 in wide and 1.76 LF long representing a pavement length of 528 LF at a scale of 1 in = 25 LF. A plastic scale for the Profilograph may be obtained by the regions from the State Materials Laboratory. Near the center of the scale is an opaque band 0.2 in wide extending the entire length of 21.12 in. On either side of this band are scribed lines 0.1 in apart, parallel to the opaque band. These lines serve as a convenient scale to measure deviations or excursions of the graph above or below the blanking band. These are called “scallop.”

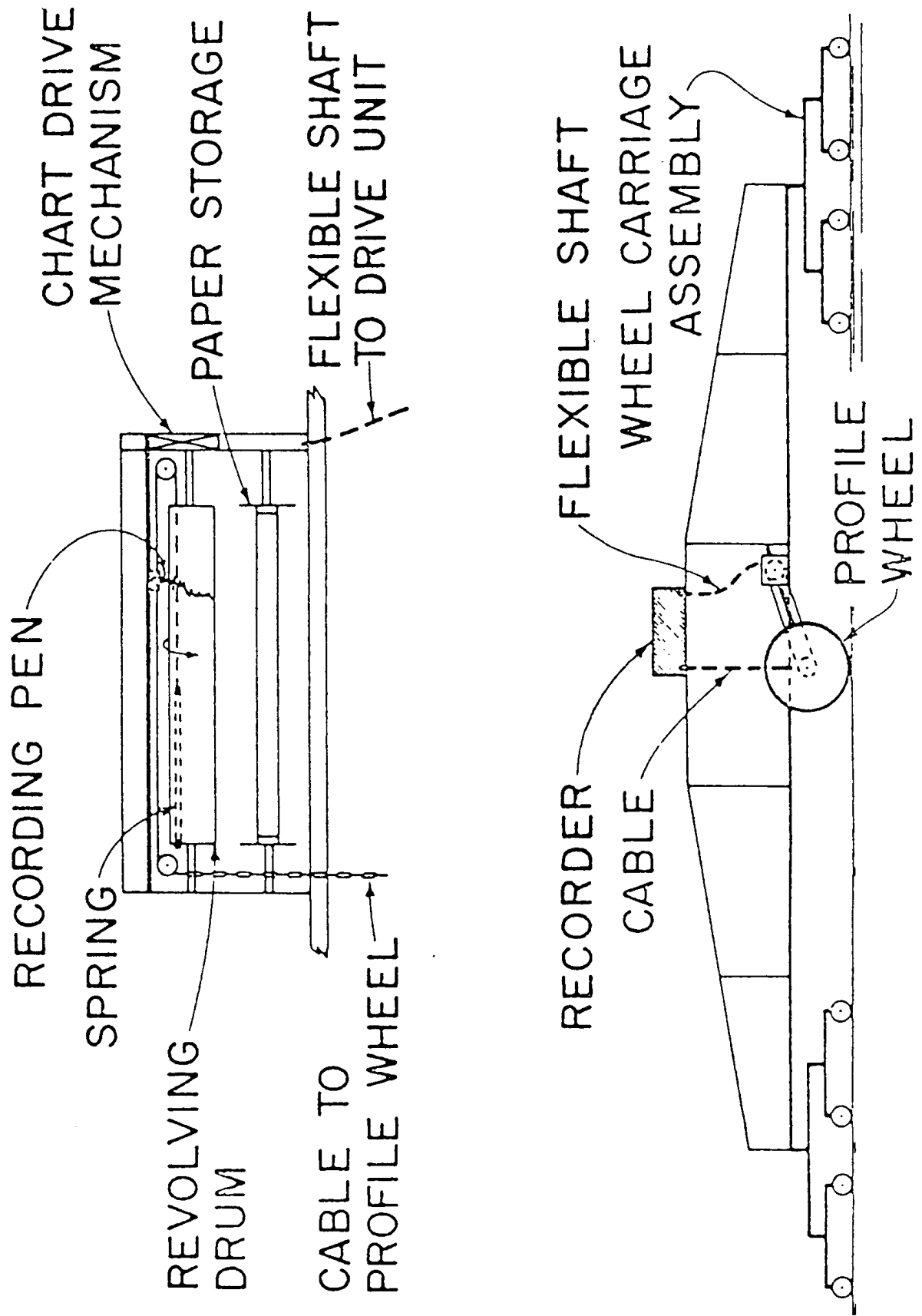

Figure 1



- b. Method of Counting – Place the plastic scale over the profile in such a way as to “blank out” as much of the profile as possible. When this is done, the scallops above and below the blanking band usually will be approximately balanced. See [Figure 2](#).

The profile trace will move from a generally horizontal position when going around super-elevated curves making it impossible to blank out the central portion of the trace without shifting the scale. When such a condition occurs, the profile should be broken into short sections and the blanking band repositioned on each section while counting as shown in the upper part of [Figure 3](#).

Starting at the right end of the scale, measure and total the height of all the scallops appearing both above and below the blanking band, measuring each scallop to the nearest 0.05 in (half a tenth). Write this total on the profile sheet near the left end of the scale together with a small mark to align the scale when moving to the next section. Short portions of the profile line may be visible outside the blanking band but unless they project 0.03 in or more and extend longitudinally for 2 LF (0.08 in on the profilogram) or more, they are not included in the count. (See [Figure 2](#) for illustration of these special conditions.)

When scallops occurring in the first 0.1 mile are totaled, slide the scale to the left, aligning the right end of the scale with the small mark previously made, and proceed with the counting in the same manner. The last section counted may or may not be an even 0.1 mile. If not, its length should be scaled. An example follows:

	Section Length, miles	Counts, tenth of an inch
	0.10	5.0
	0.10	4.0
	0.10	3.5
400 ft =	0.076	2.0
Total	0.376	14.5

The Profile Index is determined as “inches per mile in excess of the 0.2 in blanking band” but is simply called the Profile Index. The procedure for converting counts of Profile Index is as follows:

Using the figures from the above example:

Length = 0.376 mi., total count = 14.5 tenths of an inch

$$\text{Profile Index} = \frac{1 \text{ mile}}{\text{length of profiles in miles}} \times \text{a total count in inches}$$

$$\text{Pr I} = \frac{1 \text{ mile}}{0.376 \text{ mile}} \times 1.45 = 3.9$$

(Note that the formula uses the count in inches rather than tenths of an inch and is obtained by dividing the count by ten.)

EXAMPLE SHOWING METHOD OF DERIVING PROFILE INDEX FROM PROFILOGRAMS

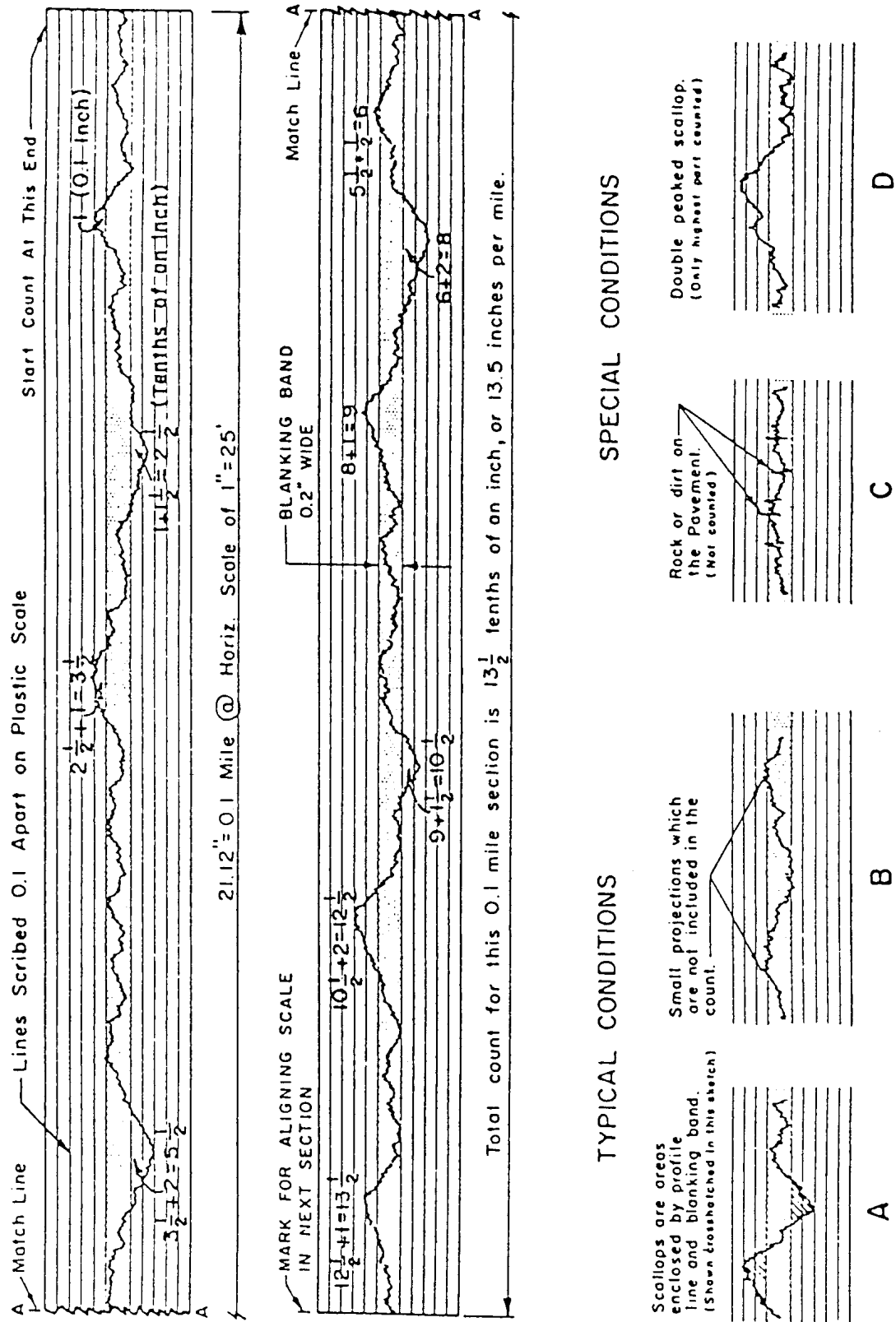
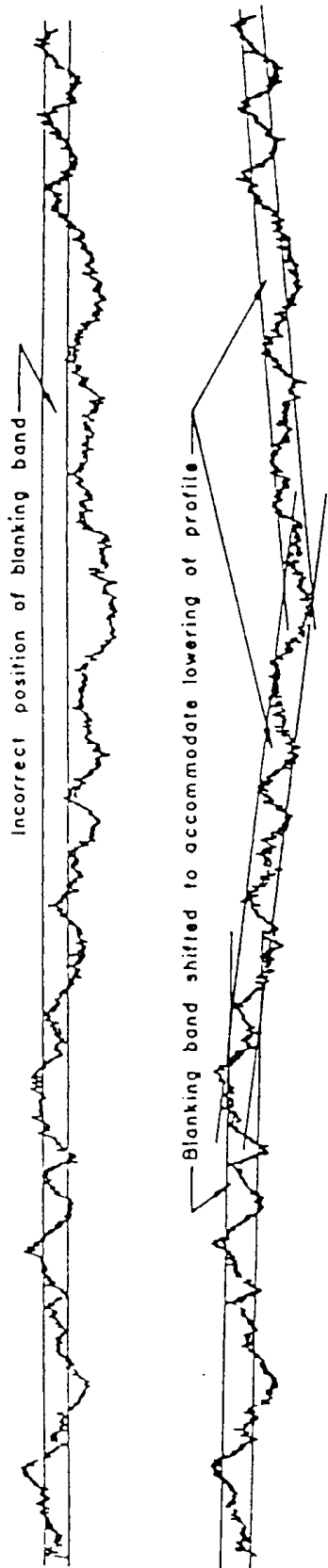

Figure 2

METHOD OF COUNTING WHEN POSITION OF PROFILE SHIFTS AS IT MAY  
WHEN ROUNDING SHORT RADIUS CURVES WITH SUPERELEVATION



METHOD OF PLACING TEMPLATE WHEN LOCATING BUMPS TO BE REDUCED

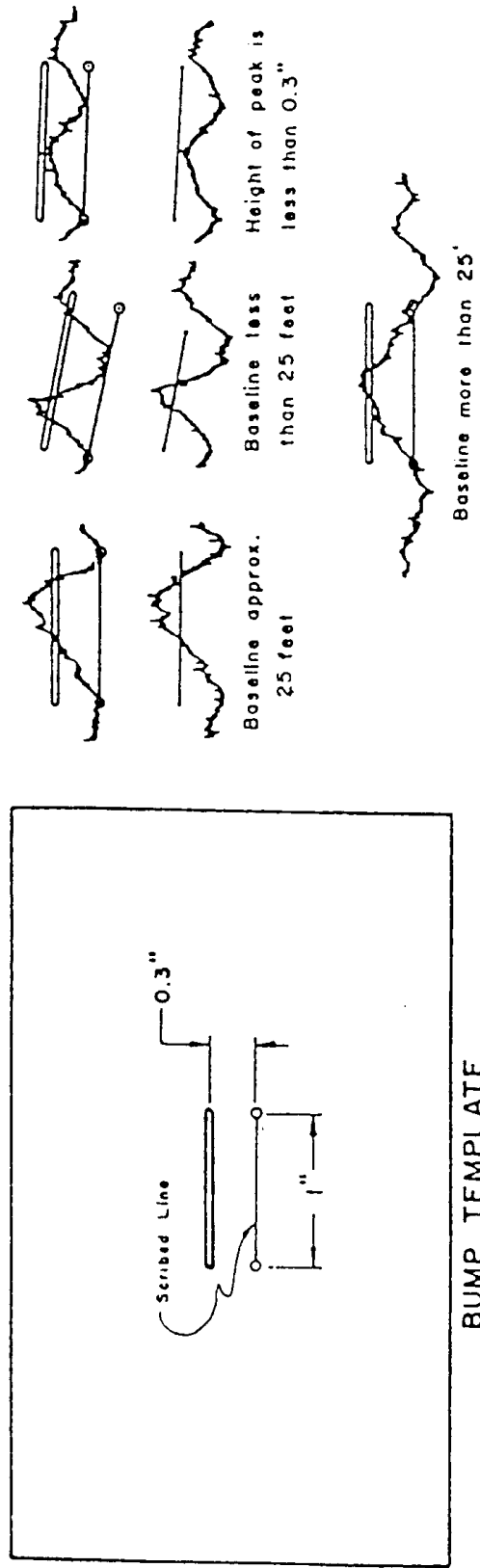

Figure 3

The Profile Index is thus determined for the profile of any line called for in the specifications.

To determine the daily profile index to check the Contractors methods and procedures, profile indexes may be averaged for two or more profiles of the same section of road if the profiles are the same length.

Example:

		<b>Counts, tenths of an inch</b>	
		<b>Left</b>	<b>Right</b>
		<b>wheel track</b>	<b>wheel track</b>
<b>Section Length,</b>			
<b>miles</b>			
	0.10	5.0	4.5
	0.10	4.0	5.0
	0.10	3.5	3.0
400 LF =	0.076	2.0	1.5
	<b>Total</b>	<b>14.5</b>	<b>14.0</b>
	Prl (by formula)	3.9	3.7

$$\text{Averages} = \frac{3.9 + 3.7}{2} = 3.8$$

The specifications state which profiles to use when computing the average Profile Index for control of construction operations.

- c. Limitations of Count in 0.1 Mile Sections – When the specifications limit the amount of roughness in “any one-tenth mile section,” the scale is moved along the profile and counts made at various locations to find those sections if any, that do not conform to specifications. The limits are then noted on the profile and can be later located on the pavement preparatory to grinding.
- d. Limits of Counts – Joints – When counting profiles, a day’s paving is considered to include the last portion of the previous day’s work, which includes the daily joint. The last 15 to 30 LF of a day’s paving cannot usually be obtained until the following day. In general, the paving contractor is responsible for the smoothness of joints if he places the concrete pavement on both sides of the joint. On the other hand, the contractor is responsible only for the pavement placed by him if the work abuts a bridge or a pavement placed under another contract. Profilograph readings when approaching such joints should be taken in conformance with current specifications.

**Part III**  
**Determination of High Points in Excess of 0.3 in**

**4. Procedure**

- a. Equipment – Use a plastic template having a line 1 in long scribed on one face with a small hole or scribed mark at either end, and a slot 0.3 in from and parallel to the scribed line (see [Figure 3](#)). (The 1 in line corresponds to a horizontal distance of 0.3 in on the horizontal scale of the profilogram.) The plastic template may be obtained from the State Materials Laboratory.
- b. Locating High Points in Excess of 0.3 in – At each prominent peak or high point on the profile trace, place the template so that the small holes or scribe marks at each end of the scribed line intersect the profile trace to form a chord across the base of the peak or indicated bump. The line on the template need not be horizontal. With a sharp pencil, draw a line using the narrow slot in the template as a guide. Any portion of the trace extending above this line will indicate the approximate length and height of the deviation in excess of 0.3 in.

There may be instances where the distance between easily recognizable low points is less than 1 in (25 LF). In such cases, a shorter chord length shall be used in making the scribed line on the template tangent to the trace at the low points. It is the intent, however, of this requirement that the baseline for measuring the height of bumps will be as near 25 LF as possible, but in no case to exceed this value. When the distance between prominent low points is greater than 25 LF, make the ends of the scribed line intersect the profile trace when the template is in a nearly horizontal position. A few examples of the procedure are shown in the lower portion of [Figure 3](#).





## **WSDOT Test Method T 808**

### ***Method for Making Flexural Test Beams***

#### **1. Scope**

- a. This method covers the procedures for molding and curing Portland cement concrete flexural test beams.

#### **2. Equipment**

- a. Test beam molds, 6 in × 6 in × 21 ± ½ in (150 mm × 150 mm × 550 ± 13 mm) or 8 in × 8 in × 26 ± ½ in (200 mm × 200 mm × 670 ± 13 mm).
- b. Vibrator, capable of 7,000 vibrations per minute with a diameter not less than ¾ in (19.0 mm) or greater than 1½ in (38.1 mm).
- c. Tamping Rod – The tamping rod is a round, straight steel rod ⅝ in (16.0 mm) diameter and approximately 24 in (610 mm) long, having the tamping end rounded to a ⅝ in (16.0 mm) diameter hemispherical tip.
- d. Mallet – A mallet with a rubber or rawhide head weighing 1.25 ± 0.50 lb (0.57 ± 0.23 kg).
- e. Assorted tools such as scoops, shovels, etc.

#### **3. Procedure**

- a. For laboratory made beam specimens, mix sufficient concrete to make all the required specimens from one batch. Each beam specimen requires approximately .45 ft<sup>3</sup> (0.015 m<sup>3</sup>) of concrete.

For field-made beam specimens, the concrete sample is obtained in accordance with WSDOT Test Method No. 803, Method of Sampling Fresh Concrete. Making of the beam specimens shall begin within 15 minutes of remixing the sample.

- b. Mold specimens as near as practicable to the place where they are to be stored during the first 24 hours.
- c. Assemble the molds on a rigid surface free from vibration and other disturbances. Remix the concrete to a uniform appearance. When the method of consolidation is by internal vibrators, the mold is filled in a single layer. Make sure that each shovel or scoop of concrete is representative of the batch. When the method of consolidation is by rodding, the mold is filled in two layers with each layer being rodded one time for each 2 in<sup>2</sup> (1290 mm<sup>2</sup>) of surface area. The rodding should be distributed evenly over the entire surface. On the succeeding layers, the rod should not penetrate the previous layer more than ½ in (13 mm). After each layer is rodded, tap the outsides of the mold lightly 10 to 15 times with a mallet.
- d. Insert the vibrator at intervals not to exceed 6 in (150 mm) along the centerline of the long dimension of the beam. For specimens wider than 6 in (150 mm), use alternating insertions along two lines at least 2 in (50 mm) away from the sides of the mold. Withdraw the vibrator so that no air voids are left in the concrete. Then tap the mold lightly 10-15 times with mallet.

- e. Finish the surface of the concrete by striking off with a straightedge. Use the minimum amount of manipulation necessary to leave a flat surface that has no depressions or projections larger than  $\frac{1}{8}$  in (3.2 mm) and is level with the sides of the mold.
- f. The top surface of the laboratory-made specimen shall be covered with a saturated towel and a plastic sheet to prevent moisture loss from the concrete.

For the field made specimen, the top surface of the beam shall be sprayed with the same curing compound as is used for the pavement and covered with a plastic tarpaulin.

#### 4. Storage and Handling

The method of storing and handling the beam specimen depends on the purpose for which the beam is intended. Two methods are provided as follows:

- a. Laboratory Method – Beam for determining the acceptability of a contractor-provided paving mix.

Cover the beam to prevent moisture loss and allow beam to remain undisturbed for an initial cure period of  $24 \pm 4$  hours at a temperature of  $60^\circ$  to  $80^\circ\text{F}$  ( $16^\circ$  to  $27^\circ\text{C}$ ). After the initial cure period, the beam will be removed from the mold and within 30 minutes stored in saturated limewater at  $73.4^\circ \pm 3^\circ\text{F}$  ( $23^\circ \pm 2^\circ\text{C}$ ) for a minimum of 20 hours prior to testing. Surface drying of the beam between removal from the limewater and completion of testing shall be prevented. Relatively small amounts of drying of the test beam surfaces induces tensile stress in the extreme fibers that will markedly reduce the indicated flexural strength.

- b. Field Method – Beam for determining the flexural strength of the in-place pavement.

After applying the curing compound to the top surface, cover the beam specimen with white reflective sheeting and allow beams to remain undisturbed for an initial cure period of  $24 \pm 4$  hours at ambient conditions. After the initial cure period, remove the specimen from the mold and cure the specimen either by:

- (1) Burying the specimen in wet sand making sure that the specimen is never allowed to become surface dry. Temperature of the sand should be similar to the concrete pavement temperature, or
- (2) Wrap the beam in a saturated towel, place in a plastic bag, and seal the opening. The plastic should be at least 4 mils thick. Leave the specimen on the pavement in the vicinity where it was molded until time to test. Take specimen to the testing location and store in lime water at  $73.4^\circ \pm 5^\circ\text{F}$  ( $23^\circ \pm 2.8^\circ\text{C}$ ) for  $24 \pm 4$  hours immediately before time of testing to ensure uniform moisture condition from specimen to specimen.

**Note:** The beam specimen must be kept in a surface moist condition or wet environment for the entire time in storage **and** testing. Even minor amounts of surface drying of the specimen induces extreme fiber stresses which can markedly reduce the flexural strength.

#### 5. Testing

- a. Beam specimens are tested for flexural strength in accordance with WSDOT Test Method No. 802.



# Performance Exam Checklist

## WSDOT T 808

### Method for Making Flexural Test Beams

Participant Name: \_\_\_\_\_ Exam Date: \_\_\_\_\_

Record the symbols "P" for passing or "F" for failing on each step of the checklist.

Procedure Element	Trial 1	Trial 2
1. Copy of current procedure available at test site?	_____	_____
2. Making of test specimens begins within 15 minutes for sampling?	_____	_____
3. Assemble of molds on a rigid surface free from vibration and other disturbances?	_____	_____
4. Concrete remixed to a uniform appearance?	_____	_____
5. When method of concrete consolidation is by rodding:		
a. Mold filled in two layers?	_____	_____
b. Each layer rodded one time for each 2 in <sup>2</sup> (1290 mm) of mold surface area?	_____	_____
c. Rodding, evenly distributed over the entire surface area?	_____	_____
d. After rodding each layer, mold tapped lightly 10-15 times with mallet?	_____	_____
6. When method of concrete consolidation is by internal vibrators:		
a. Mold filled in a single layer?	_____	_____
b. Vibrator inserted at intervals not to exceed 6 in (150 mm) along the centerline of the long dimension?	_____	_____
c. For molds wider than 6 in (150 mm), vibrator inserted along two alternating lines at least 2 in (50 mm) away from sides of mold?	_____	_____
d. Mold tapped lightly 10-15 times with mallet?	_____	_____
7. Top of mold properly finished?	_____	_____
8. Top of mold properly treated to prevent moisture loss?	_____	_____

### Equipment

- |   |       |       |
|---|-------|-------|
| 1. Where required are calibration/verifications tags present on equipment used in this procedure? | _____ | _____ |
| 2. All equipment functions according to the requirements of this procedure?                       | _____ | _____ |

Comments: First Attempt: Pass \_\_\_\_\_ Fail \_\_\_\_\_ Second Attempt: Pass \_\_\_\_\_ Fail \_\_\_\_\_

Examiner Signature: \_\_\_\_\_ WAQTC #: \_\_\_\_\_





## WSDOT Test Method T 813

### *Field Method of Fabrication of 2 in (50 mm) Cube Specimens for Compressive Strength Testing of Grouts and Mortars*

#### 1. Scope

This method covers the fabrication of 2 in (50 mm) cube specimens for compressive strength testing of grouts and mortars.

#### 2. Equipment

- a. **Specimen Molds** – Specimen molds for the 2 in (50 mm) cube specimens shall be tight fitting. The molds shall not have more than three cube compartments and shall not be separable into more than two parts. The parts of the molds, when assembled, shall be positively held together. The molds shall be made of hard metal not attacked by the cement mortar. For new molds, the Rockwell hardness number shall not be less than HRB 55. The sides of the molds shall be sufficiently rigid to prevent spreading or warping. The interior faces of the molds shall conform to the tolerances of Table 1.

**Table 1 Permissible Variations of Specimen Molds**

Parameter	2 in Cube Molds		50 mm Cube Molds	
	New	In Use	New	In Use
Planeness of Sides	<0.001 in	<0.002 in	<0.025 mm	<0.05 mm
Distance Between Opposite Sides	2 in ± 0.005 in	2 in ± 0.02 in	50 mm + 0.13 mm	50 mm + 0.50 mm
Height of Each Compartment	2 in + 0.001 in to -0.005 in	2 in + 0.01 in to -0.015 in	50 mm + 0.25 mm to -0.013 mm	50 mm + 0.25 mm to -0.38 mm
Angle Between Adjacent Faces*	90 + 0.5°	90 + 0.5°	90 + 0.5°	90 + 0.5°

\*Measured at points slightly removed from the intersection. Measured separately for each compartment between all the interior faces and the adjacent face and between interior faces and top and bottom planes of the mold.

- b. **Base Plates** – Base plates shall be made of a hard metal not attacked by cement mortar. The working surface shall be plane and shall be positively attached to the mold with screws into the side walls of the mold.
- c. **Cover Plates** – Cover plates shall be made of a hard metal or glass not attacked by cement mortar. The surface shall be relatively plane.

- d. **Tamper** – The tamper shall be made of a nonabsorptive, nonabrasive, nonbrittle material such as a rubber compound having a Shore A durometer hardness of 80 + 10, or seasoned oak wood rendered nonabsorptive by immersion for 15 minutes in paraffin at approximately 392°F (200°C), and shall have a cross-section of ½ in × 1 in (13 mm × 25 mm) and a length of about 5 to 6 in (125 to 150 mm). The tamping face shall be flat and at right angles to the length of the tamper.
- e. **Trowel** – A trowel which has a steel blade 4 to 6 in (100 to 150 mm) in length, with straightedges.

**3. Field Procedure**

- a. Three or more specimens shall be made for each period of test specified.
- b. All joints shall be water tight. If not water tight, seal the surfaces where the halves of the mold join by applying a coating of light cup grease. The amount should be sufficient to extrude slightly when the halves are tightened together. Repeat this process for attaching the mold to the base plate. Remove any excess grease.
- c. Apply a thin coating of release agent to the interior faces of the mold and base plate. (WD-40 has been found to work well as a release agent.) Wipe the mold faces and base plate as necessary to remove any excess release agent and to achieve a thin, even coating on the interior surfaces. Adequate coating is that which is just sufficient to allow a distinct fingerprint to remain following light finger pressure.
- d. Begin molding the specimens within an elapsed time of not more than 2½ minutes from completion of the mixing.
- e. For plastic mixes, place a first layer of mortar about 1 in (25 mm) deep in all the cube compartments (about one-half the depth of the mold). Tamp the mortar in each cube compartment 32 times in about 10 seconds making four rounds, each round perpendicular to the other and consisting of eight adjoining strokes over the surface of the specimen, as illustrated in Figure 1, below. The tamping pressure should be just sufficient to ensure uniform filling of the molds. The four rounds of tamping (32 strokes) shall be completed in one cube before going on to the next. When the tamping of the first layer is completed, slightly over fill the compartments with the remaining mortar and then tamp as specified for the first layer. During tamping of the second layer, bring in the mortar forced out onto the tops of the molds after each round of tamping, by means of gloved fingers and the tamper, before starting the next round of tamping. On completion of tamping, the tops of all the cubes should extend slightly above the tops of the molds.

**Figure 1**

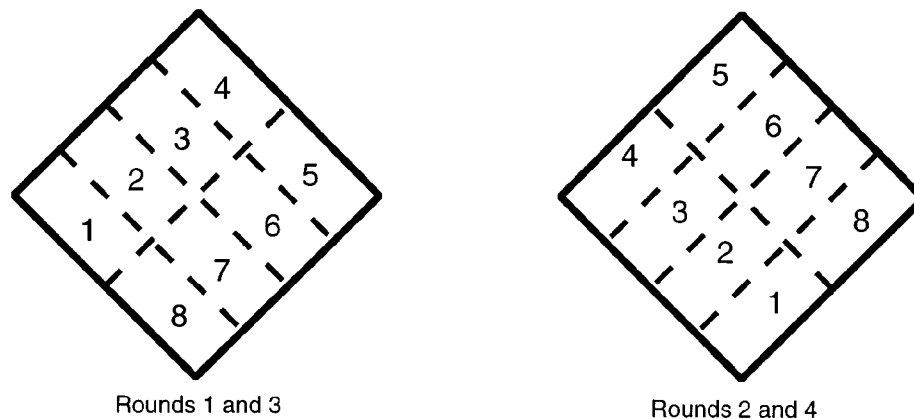

- f. Bring in the mortar that has been forced out onto the tops of the molds with a trowel and smooth off the cubes by drawing the flat side of the trowel (with the leading edge slightly raised) once across the top of each cube at right angles to the length of the mold. Then, for the purpose of leveling the mortar and making the mortar that protrudes above the top of the mold of more uniform thickness, draw the flat trailing edge of the trowel (with leading edge slightly raised) once lightly along the length of the mold. Cut off the mortar to a plane surface flush with the top of the mold by drawing the straight edge of the trowel (held nearly perpendicular to the mold) with a sawing motion over the length of the mold.
- g. When fabricating fluid mixes, steps e. and f. need not be followed. Instead, the cube mold is filled with mortar and cut off to a plane surface with a sawing motion over the length of the mold.
- h. Immediately after molding, place cover plate on top of the mold, cover the sample with wet burlap, towels, or rags, seal it in a plastic sack in a level location out of direct sunlight, avoid freezing of cubes and record the time. Allow the sample to set undisturbed, away from vibration, for a minimum of four hours or as recommended by manufactures instructions before moving.
- i. Deliver the sample to the Regional or State Materials Laboratory **in the mold** with the cover plate in wet burlap, towels or rags sealed in a plastic bag within 24 hours. **Time of molding MUST be recorded on the Concrete Transmittal.** If delivery within 24 hours is unachievable, contact the Laboratory for instructions on caring for the cubes.
- j. Once received in the lab, the molded sample is to be immediately placed in a moist curing room, with the upper surfaces exposed to the moist air but protected from dripping until the sample is a minimum of 20 hours old or has cured sufficiently that removal from the mold will not damage the cube. If the specimens are removed from the mold before they are 24 hours old they are to be kept on the shelves of the moist curing room until they are 24 to 36 hours old.
- k. When the specimens are 24 to 36 hours old, immerse them in a lime-saturated water storage tank (Note 1). The specimens are to remain in the storage tank until time of test. (Curing test specimens of material other than hydraulic cement shall be in conformance with the manufacturer's recommendations.)

**Note 1:** The storage tank shall be made of noncorroding materials. The water shall be saturated with calcium hydroxide such that excess is present. Stir the lime-saturated water once a month and clean the bath as required by AASHTO M 201.



## Performance Exam Checklist

### WSDOT Test Method T 813

#### *Field Method of Fabrication of 2 in (50 mm) Cube Specimens for Compressive Strength Testing of Grouts and Mortars*

Participant Name: \_\_\_\_\_ Exam Date: \_\_\_\_\_

Record the symbols "P" for passing or "F" for failing on each step of the checklist.

Procedure Element	Trial 1	Trial 2
1. The tester has a copy of the current procedure on hand?	_____	_____
2. All equipment is functioning according to the test procedure, and if required, has the current calibration/verification tags present?	_____	_____
3. Three cubes made for each time period of test?	_____	_____
4. All joints (mold halves, mold to base plate) shall be water tight?	_____	_____
5. Adequate coating of release agent applied to interior surfaces of the mold?	_____	_____
6. Molding began within 2½ minutes from completion of mixing?	_____	_____
7. Molding performed in two lifts? (Not necessary if mix is fluid.)	_____	_____
8. Lifts tamped 32 times, made up of 4 rounds of 8, each perpendicular to the other? (Not required if mix is fluid.)	_____	_____
9. For second layer, mortar forced out of the mold brought back in before each round? (Not required if mix is fluid.)	_____	_____
10. Mix extends slightly above the mold at the completion of tamping?	_____	_____
11. Mortar smoothed by drawing flat side of trowel across each cube at right angles?	_____	_____
12. Mortar leveled by drawing the flat side of trowel lightly along the length of mold?	_____	_____
13. Mortar cut off flush with mold with edge of trowel using sawing motion?	_____	_____
14. Time of molding recorded?	_____	_____
15. Cover plate placed on top of the mold and covered with wet burlap, towel or rag?	_____	_____
16. Covered sample sealed in a plastic sack in a level location out of sunlight?	_____	_____
17. Sample delivered to the laboratory in the mold within 24 hours?	_____	_____
18. Transmittal includes the time of molding?	_____	_____

Comments: First Attempt: Pass \_\_\_\_\_ Fail \_\_\_\_\_ Second Attempt: Pass \_\_\_\_\_ Fail \_\_\_\_\_

Examiner Signature: \_\_\_\_\_ WAQTC #: \_\_\_\_\_







## WSDOT Test Method T 814

### *Method of Test for Water Retention Efficiency of Liquid Membrane-Forming Compounds and Impermeable Sheet Materials for Curing Concrete*

#### 1. SCOPE

This method is intended for laboratory use in determining the efficiency of liquid membrane-forming compounds, papers, and other impermeable sheet materials for curing concrete, as measured by their ability to prevent moisture loss during the early hardening period.

#### 2. APPARATUS

- a. Molds – The molds shall be seamless tin cans, of dimensions approximately 3.5 in. (90 mm) in diameter by 1.18 in. (30. mm) deep.
- b. Mortar – Mortar for test specimens shall consist of a Type II Portland cement, standard graded sand, and water; all well mixed in the proportions by mass of 1 part cement, 0.4 parts water, and sufficient sand to create a flow of  $35 \pm 5$  after 10 drops when tested per C87. The Portland cement shall conform to the *Standard Specifications for Portland cement*, ASTM C150. The sand shall conform to the specifications for graded standard sand, ASTM C778.
  - (1) Mixing – Mixing shall preferably be done in a room in which the air temperature is  $73.4^{\circ}\text{F} \pm 7^{\circ}\text{F}$  ( $23^{\circ} \pm 4^{\circ}\text{C}$ ) and relative humidity of not less than 50%. The temperature of the water at the time of mixing shall be  $73.4^{\circ}\text{F} \pm 3.6^{\circ}\text{F}$  ( $23^{\circ} \pm 2^{\circ}\text{C}$ ). Follow the mixing procedure given in T 162.
  - (2) Molding – The mold shall be filled with mortar and the mortar puddled with the gloved fingers only to the extent required for uniform and thorough consolidation. Excess mortar shall be removed and the surface smoothed with the gloved hands, immediately after which the surface shall be finished with one pass of a straightedge, using pressure and a sawing motion.
  - (3) Storage – Immediately after molding, the excess mortar on the outside of the molds shall be removed with a damp cloth. The molds containing the specimens shall be placed in a moist closet in an atmosphere maintained at  $73.4^{\circ}\text{F} \pm 3.6^{\circ}\text{F}$  ( $23^{\circ} \pm 2^{\circ}\text{C}$ ) and relative humidity of not less than 95 percent.

### 3. PROCEDURE

- a. Application of Compound – Four hours after molding, the specimens shall be removed from the moist closet and the junction of specimen and mold sealed by means of a hot applied rosin/paraffin wax sealing material applied to the edges by means of a small brush or syringe, and shall not extend more than 3/16 in. (4.8 mm) onto the surface of the specimen.

A single coat of curing compound shall be applied to each specimen by the use of a brush. The compound shall be applied at the rate of 1.29 ml per test specimen. The proper mass of compound for the prescribed coverage shall be determined from the specific gravity of the material. This mass of compound ( $\pm 0.05$  g) shall be measured by weighing the test specimens before and after application. When testing impermeable sheet materials, the sample is taped over the specimen with a pressure sensitive tape.

- b. Determination of Moisture Loss – One-half hour after application of the curing compound, each of the coated specimens shall be placed individually in 4-in. (101.6 mm) Scheibler desiccators on a metal platform. A 30 to 50 mm low form glass weighing bottle containing approximately 20 g of potassium hydroxide pellets, accurately weighed to the nearest 0.01 g, shall be placed under the suspended coated specimens. The cover of the weighing bottle shall be removed, and desiccator closed tightly with its cover. The desiccators shall be kept at a temperature of  $70^{\circ}\text{F} \pm 2^{\circ}\text{F}$  ( $21^{\circ} \pm 1^{\circ}\text{C}$ ) for 72 hours. At the conclusion of this period, the desiccator shall be opened, the cover shall be placed on the weighing bottle, and the mass (weight) determined to the nearest 0.01 g. The increase in mass (weight) of the potassium hydroxide shall be taken as the loss of moisture from the specimen. The results of not less than three test specimens shall be averaged in computing the loss of moisture.

### 4. REPORTS

- a. Test results are calculated and reported out through MATS.



## WSDOT Test Method T 818

### *Air Content of Freshly Mixed Self-Compacting Concrete by the Pressure Method*

1. The air test will be performed in accordance with WSDOT FOP for WAQTC T 152 with the following modifications to the procedure:

a. Change item 3 to read: Fill the base completely in one lift.

**Note:** Filling the base with concrete by using multiple scoops or by pouring from a bucket or similar container has been found to be acceptable.

b. Change item 4 to read: Do not consolidate the concrete by rodding, vibration, or tamping. When the base is filled, lightly tap around the exterior of the base with a rubber mallet to allow entrapped air bubbles to escape.

c. Delete items 5 through 11.



# Performance Exam Checklist

## WSDOT T 818

### *Air Content of Freshly Mixed Self Compacting Concrete by the Pressure Method*

Participant Name: \_\_\_\_\_ Exam Date: \_\_\_\_\_

Record the symbols "P" for passing or "F" for failing on each step of the checklist.

Procedure Element	Trial 1	Trial 2
1. The tester has a copy of the current procedure on hand?	_____	_____
2. All equipment is functioning according to the test procedure, and if required, has the current calibration/verification tags present?	_____	_____
3. Container filled in one layer, slightly overfilling?	_____	_____
4. Sides of the container lightly tapped with the mallet?	_____	_____
5. Concrete struck off level with top of container using the bar and rim cleaned off?	_____	_____
6. Inside of cover cleaned and moistened before clamping to base?	_____	_____
<b>Using a Type B Meter</b>		
7. Both petcocks open?	_____	_____
8. Air valve closed between air chamber and the bowl?	_____	_____
9. Water injected through petcock until it flows out the other petcock?	_____	_____
10. Water injection into the petcock continued while jarring and tapping the meter to insure all air is expelled?	_____	_____
11. Air pumped up to initial pressure line?	_____	_____
12. A few seconds allowed for the compressed air to stabilize?	_____	_____
13. Gauge adjusted to the initial pressure?	_____	_____
14. Both petcocks closed?	_____	_____
15. Air valve opened between chamber and bowl?	_____	_____
16. Sides of bowl tapped with the mallet?	_____	_____
17. Air percentage read after lightly tapping the gauge to stabilize the hand?	_____	_____
18. Air valve closed and then petcocks opened to release pressure before removing the cover?	_____	_____
19. Air content recorded to 0.1 percent?	_____	_____
20. All calculations performed correctly?	_____	_____

Comments: First Attempt: Pass \_\_\_\_\_ Fail \_\_\_\_\_ Second Attempt: Pass \_\_\_\_\_ Fail \_\_\_\_\_

Examiner Signature: \_\_\_\_\_ WAQTC #: \_\_\_\_\_

This checklist is derived, in part, from copyrighted material printed in ACI CP-1, published by the American Concrete Institute.



## WSDOT Test Method T 819

### *Making and Curing Self-Compacting Concrete Test Specimens in the Field*

1. The cylinders will be made and cured in accordance with WSDOT FOP for AASHTO R 100 with the following modifications:
  9. Molding Specimens
    - 9.2 Casting Cylinders is revised to read:

Place the concrete in the mold using a scoop, blunted trowel or shovel. Molds shall be filled in one layer by pouring material from a suitable container into the mold. Do not rod, vibrate, or tap the mold.

**Note:** Filling the mold with concrete by using multiple scoops or by pouring from a bucket or similar container has been found to be acceptable.
    - 9.3 Consolidation is deleted
    - 9.4 Finishing is revised to read:

Strike off the surface of the concrete level with the top of the mold using a float, trowel or steel strike off bar. Immediately after finishing place a plastic cylinder lid on the cylinder.





# Performance Exam Checklist

## *Making and Curing Self-Compacting Concrete Test Specimens in the Field* **WSDOT T 819**

Participant Name: \_\_\_\_\_ Exam Date: \_\_\_\_\_

Record the symbols "P" for passing or "F" for failing on each step of the checklist.

Procedure Element	Trial 1	Trial 2
1. The tester has a copy of the current procedure on hand?	_____	_____
2. Molds placed on a level, rigid, horizontal surface free of vibration?	_____	_____
3. Making of specimens begun within 15 minutes of sampling?	_____	_____
4. Concrete poured into the mold using a suitable container?	_____	_____
5. Mold filled in one lift?	_____	_____
6. Excess concrete struck off?	_____	_____
7. Specimens covered immediately with plastic cylinder lid?	_____	_____

Comments: First Attempt: Pass \_\_\_\_\_ Fail \_\_\_\_\_ Second Attempt: Pass \_\_\_\_\_ Fail \_\_\_\_\_

Examiner Signature: \_\_\_\_\_ WAQTC #: \_\_\_\_\_



# Performance Exam Checklist

## ASTM C 882

### Bond Strength (Diagonal Shear)

Participant Name: \_\_\_\_\_ Exam Date: \_\_\_\_\_

Record the symbols "P" for passing or "F" for failing on each step of the checklist.

Procedure Element	Trial 1	Trial 2
1. Confirmation that the concrete lab will be ready to mix mortar?	_____	_____
2. Half cylinders taken from moisture room?	_____	_____
3. Elliptical surface acid washed, rinsed with water and allowed to dry?	_____	_____
4. Half cylinders placed in cylinder molds awaiting the epoxy and mortar?	_____	_____
5. Epoxy mixed using manufacturer's mix ratio and directions?	_____	_____
6. With elliptical surface maintained horizontal, coat the surface with epoxy?	_____	_____
7. Epoxy layer thickness 10 to 15 mils (0.3 mm to 0.4 mm)?	_____	_____
After the epoxy coating:		
8. Fill up the remainder of the mold with fresh plastic mortar?	_____	_____
9. New mortar rodded and the top smoothed off?	_____	_____
10. Specimens (epoxy/mortar) cured for two (2) days or fourteen (14) days at 100% relative humidity?	_____	_____
11. Compressive load determined as per WSDOT Test Method T 22?	_____	_____
12. Compressive strength calculated based on elliptical surface area?	_____	_____

Comments: First Attempt: Pass \_\_\_\_\_ Fail \_\_\_\_\_ Second Attempt: Pass \_\_\_\_\_ Fail \_\_\_\_\_

Examiner Signature: \_\_\_\_\_ WAQTC #: \_\_\_\_\_





## WSDOT Test Method SOP 914

### *Practice for Sampling of Geosynthetic Material for Testing*

#### 1. Scope

- a. This practice covers the procedure for sampling Geosynthetic Material for testing.

#### 2. Definitions

- a. Geogrid – A regular network of integrally connected polymer tensile elements with an aperture geometry sufficient to permit mechanical interlock with the surrounding backfill.
- b. Geosynthetic Material – general term which includes all geotextiles, geogrids, and prefabricated drainage mats.
- c. Geotextile – Any permeable textile used with foundation, soil, rock, earth, or any other geotechnical material, as an integral part of a manmade product, structure, or system.
- d. Lot – All geosynthetic material rolls within a consignment (i.e., all rolls sent to the project site) which were manufactured at the same manufacturing plant having the same product name and specifications, style, or physical characteristics of a particular geosynthetic material product.
- e. Lot Sample – Sample(s) from one or more geosynthetic material rolls taken at random to represent an acceptance sampling lot and used as a source of laboratory samples.
- f. Production Unit – As referred to in this practice, it shall be considered to be synonymous with the geosynthetic material roll as shipped by the manufacturer. Two or more geosynthetic material rolls joined together by sewn seams shall be considered as separate rolls.
- g. Minimum Average Roll Value – The test results of any sampled roll in a lot shall meet or exceed the minimum values specified.

#### 3. Significance and Use

- a. Sampling is an important part of testing and the sampler should make every effort to obtain samples that will show the nature and condition of the materials they represent.
- b. This sampling procedure will provide a representation of the lot which is adequate to establish minimum average roll values as defined by this practice.

#### 4. Procedure

- a. Divide the shipment or consignment into lots as defined in 2.d.
- b. Determine the number of rolls in the shipment or consignment to be sampled using Table 1.

**Table 1**      **Number of Rolls to be Selected as Lot Sample**

Number of Rolls in Lot	Number of Rolls to be Selected for Lot Sample
1 to 24	1
25 to 49	2
50 to 99	3
100 to 125	5
125 to 216	6
217 to 343	7
344 to 512	8
513 to 729	9
730 to 1,000	10

c. Laboratory sample selection.

- (1) Obtain a laboratory sample from each roll in the Lot Sample. The sample shall be a minimum of 6 feet long by the full width of the geosynthetic material roll with a total area greater than or equal to 6.0 yd<sup>2</sup>.
- (2) The laboratory sample should not be taken from the outer wrap of the roll nor the inner wrap of the core (i.e., do not take the sample from the very ends of the roll).
- (3) Protect the sample from exposure to Ultraviolet light.

**5. Sample Submittal**

- a. All geotextile samples submitted to the State Material Laboratory are to be prepared and shipped as follows:

Roll sample around a 4 in diameter minimum, tube such as PCV pipe or cardboard mailing tube and wrap to protect sample from shipping damage and ultraviolet light (UV) exposure.

- b. If sample is for Acceptance of Lots used on project, the following information must be submitted with the sample:
- (1) Manufacturer's name and current address.
  - (2) Full product name.
  - (3) Roll number(s).
  - (4) Proposed use(s).
  - (5) Certified test results from the manufacturer.
  - (6) The Lot Number being submitted for acceptance. In lieu of a manufacturer provided Lot Number, the Bill of Lading Number can be used.

Testing by the State Materials Laboratory will not begin until all of the required information is received.



## **WSDOT Test Method T 915**

### ***Practice for Conditioning of Geotextiles for Testing***

#### **1. Scope**

- a. This practice covers a procedure for conditioning geotextile specimens for testing and establishes atmospheric conditions which are acceptable for testing when the standard atmosphere for testing cannot be obtained due to local laboratory conditions.

#### **2. Applicable Documents**

- a. ASTM Standards.
  - D 123 Terminology Relating to Textiles
  - D 1776 Practice for Conditioning Textiles for Testing
  - D 4439 Terminology for Geotextiles
  - D 4533 Standard Test Method for Trapezoid Tearing Strength of Geotextiles
  - D 4595 Standard Test Method for tensile Properties of Geotextiles by the Wide-Width Strip Method
  - D 4632 Standard Test Method for Breaking Load and Elongation of Geotextiles (Grab Method)

#### **3. Definitions**

- a. Atmosphere for Testing Geotextiles – Air maintained at a relative humidity of  $55 \pm 25$  percent relative humidity and temperature of  $70^{\circ} \pm 4^{\circ}\text{F}$  ( $21^{\circ} \pm 2^{\circ}\text{C}$ ).
- b. Geotextile – Any permeable textile used with foundation, soil, rock, earth, or any other geotechnical material, as an integral part of a manmade product, structure, or system.
- c. Specimen – A specific portion of a material or laboratory sample upon which a test is performed or which is taken for that purpose.
- d. Preconditioning – Atmospheric conditioning of a test specimen prior to testing in a specified environment in which the specimen is allowed to come to equilibrium with that specified preconditioning environment.

#### **4. Summary of Practice**

- a. Specimens are preconditioned by soaking them in distilled water for a specified period of time and are tested at ambient laboratory room temperature and humidity conditions without allowing the specimens time to come to equilibrium with the ambient testing atmosphere.

## 5. Uses and Significance

- a. The conditioning prescribed in this practice is designed to obtain reproducible test results on geotextiles.

## 6. Apparatus

- a. Water filled pan for soaking specimens.
- b. Equipment for recording the temperature of the air and the water, and the humidity of the air.

## 7. Procedure

- a. Precondition specimens by immersing them in distilled water maintained at a temperature of  $70^{\circ} \pm 4^{\circ}\text{F}$  ( $21 \pm 2^{\circ}\text{C}$ ). The time of immersion must be sufficient to wet-out the specimens thoroughly, but must be a minimum of two hours. To obtain thorough wetting, add not more than 0.05 percent of a nonionic neutral wetting agent to the water.
- b. After the specimens have been thoroughly wetted, remove each specimen from the water, and allow excess water contained in the pores of the specimen to drain from the specimen for a period of time less than or equal to one minute. After the specimen has drained during the maximum allowed time period of one minute, the specimen test must begin before nine minutes of time have elapsed from the end of the draining period.

**Note 1:** If more than a total of nine minutes from the time the specimen is removed from the water is allowed to elapse before the specimen test is actually begun, the specimen should not be considered to be thoroughly wetted. If this occurs, the specimen should be reimmersed for a minimum of two hours before a test is attempted again for that specimen. Thorough wetting is needed to ensure that the specimen is not affected by the ambient humidity conditions during testing if those ambient conditions are not at the standard atmosphere for testing.

- c. The atmosphere for testing, geotextiles must be maintained at a temperature of  $70^{\circ} \pm 4^{\circ}\text{F}$  ( $21 \pm 2^{\circ}\text{C}$ ). and a relative humidity of  $55 \pm 25$  percent.
- d. If dry testing of the geotextile is required in addition to wet testing, the specimens must be conditioned in the atmosphere for testing as stated in Section 7.3. Specimen conditioning shall be accomplished in this case by allowing the specimens to reach moisture equilibrium in the atmosphere for testing. Equilibrium is considered to have been reached when the change in the mass of the specimen in successive weighings made at intervals of not less than two hours does not exceed 0.1 percent of the mass of the specimen. Specimen immersion requirements do not apply to specimens which are to be tested dry. Specimens tested dry must be tested in the atmosphere for testing as previously defined.



# Performance Exam Checklist

## WSDOT T 915

### Practice for Conditioning of Geotextiles for Testing

Participant Name: \_\_\_\_\_ Exam Date: \_\_\_\_\_

Record the symbols "P" for passing or "F" for failing on each step of the checklist.

Procedure Element	Trial 1	Trial 2
1. The tester has a copy of the current procedure on hand?	_____	_____
2. All equipment is functioning according to the test procedure, and if required has the current calibration/standardization/check and maintenance tags present?	_____	_____
3. Were test specimens, pre-conditioned in distilled water with not more than 0.05 % of a nonionic neutral wetting agent added at 70 ± 4° F (21 ± 2° C), thoroughly wetted and soaked for a minimum of 2 hours?	_____	_____
4. Were test specimens removed for testing and allowed to drain for 1 minute?	_____	_____
5. Was testing of specimen started before 9 minutes had elapsed from end of draining period?	_____	_____
6. If more than 9 minutes had elapsed, was test specimen returned to water bath for a minimum of 2 hours?	_____	_____
7. Was atmosphere for testing done at temperature of 70 ± 4° F (21 ± 2° C) and relative humidity of 55 ± 25%?	_____	_____
8. If dry testing is required, were the specimens conditioned according to question, number 3 above?	_____	_____
9. Was successive weighing done at intervals of 2 hours min. to determine max loss of 0.1 percent?	_____	_____

Comments: First Attempt: Pass \_\_\_\_\_ Fail \_\_\_\_\_ Second Attempt: Pass \_\_\_\_\_ Fail \_\_\_\_\_

Examiner Signature: \_\_\_\_\_ WAQTC #: \_\_\_\_\_





## WSDOT Test Method T 923

### *Thickness Measurement of Geotextiles*

#### 1. Scope

- a. This test method provides procedures for measuring the thickness of geotextiles.

#### 2. Summary of Method

- a. Specimens from the geotextile sample submitted for testing are measured for thickness and the average of those measurements is used as the multiplier in converting permittivity to permeability. The measured thickness is reported as information only in case disagreements arise concerning the permeability of the material.

#### 3. Apparatus

- a. The thickness measurement instrument shall be a precision electronic micrometer conforming to ASTM D 1777-64
- b. The specimen cutting template shall meet the requirements of ASTM D 4491 for cutting the specimens to size.

#### 4. Specimens for Testing

- a. Specimens shall be cut from the sample submitted for testing in the pattern and number specified in ASTM D 4491.

#### 5. Conditioning

- a. Thickness testing shall be done prior to conditioning the specimens for permeability testing.

#### 6. Procedure

- a. Handle the specimens carefully to avoid altering the natural state of the material.
- b. Turn the machine on and allow it to warm up for approximately five minutes. As the machine cycles, clean presser foot and base by inserting a clean, lint free cloth between presser foot and base while in the raised position. Carefully and gently pull the cloth from between presser foot and base as the foot is in lowered position. Allow the machine to cycle for several readings and if no variation, zero machine with the zero set knob. Repeat cleaning and zeroing process a second time to ensure the base and foot are clean.
- c. As the machine cycles to a raised presser foot position, (with a zero reading) quickly but carefully insert the sample under the presser foot in a centered position.
- d. The machine will cycle presser foot down. Record the reading of the first cycle only. Record the reading to 0.00030 in (0.01 mm).
- e. When the machine cycles up remove the sample and allow the machine to cycle with no sample. Check for zero reading. If machine does not read zero repeat cleaning procedure b.

- f. Continue to measure the remaining specimens using these same procedures.
- g. Average the readings and record the results.
- h. Report the average reading on the worksheet for permeability testing as the nominal thickness of the geotextile.

## **7. Calibration**

- a. The thickness measuring micrometer shall be calibrated in accordance with the manufacturers' directions once a year, and will be checked accuracy on the first working day of each month. Accuracy shall be within 0.00030 in (0.01 mm).

## **WSDOT Standard Practice T 925**

### ***Standard Practice for Determination of Long-Term Strength for Geosynthetic Reinforcement***

Summary and Use of Standard Practice

Abbreviations and Symbols

Definitions

Test Methods and Practices Used

Data Requirements for Initial Product Acceptance

1. General Product Information (required for all geosynthetic reinforcement products):
2. Installation Damage Data Requirements ( $RF_{ID}$ ):
3. Creep Data Requirements ( $RF_{CR}$  and Creep Stiffness  $J$ ):
4. Long-Term Durability Data Requirements ( $RF_D$ ):7
5. Evaluation of Product Lines

Determination of Long-term Geosynthetic Strength for Initial Product Acceptance

1. Calculation of Long-Term Strength
2. Wall or Slope Class
3. Environment Aggressiveness
4. Requirements for Class 1 Walls and Slopes to Determine  $T_{al}$
5. Requirements for Class 2 Walls and Slopes to Determine  $T_{al}$
6. Minimum Polymer and Physical Property Requirements to Allow Use of Default Reduction Factors for  $RF$  and  $RF_D$  in Nonaggressive Environments

Quality Assurance Requirements for Products that have been Through Initial Acceptance

1. Data Verification Requirements
2. Quality Assurance (QA) Testing Approach
3. Quality Assurance (QA) Sampling
4. Quality Assurance (QA) Testing
  - A. Installation Damage Testing
  - B. Creep Testing
  - C. Durability Testing

5. Quality Assurance (QA) Criteria for Comparison to Initial Product Acceptance Test Results
  - A. Short-term Index Tensile Testing
  - B. Installation Damage Testing
  - C. Creep Rupture Testing for Prediction of Creep Limit
  - D. Creep Strain Testing for Prediction of Creep Limit
  - E. Assessment of the Creep Stiffness at Low Strain
  - F. Durability Testing

References

WSDOT Test Method No. 925, Appendix A

References

WSDOT Test Method No. 925, Appendix B

- B.1 Overview of Extrapolation Approach to Determine the Ultimate Limit State Creep Limit,  $T_1$
- B.2 Step-By-Step Procedures for Extrapolating Creep Rupture Data –Conventional Method
- B.3 Procedures for Extrapolating Creep Rupture Data – Stepped Isothermal Method (SIM)
- B.4 Determination of  $RF_{CR}$
- B.5 Use of Creep Data from “Similar” Products and Evaluation of Product Lines

References

WSDOT Test Method No. 925, Appendix C

- C.1 Creep Strain Assessment Tools and Concepts
- C.2 Creep Strain Data Extrapolation
  - C.2.1 Step-By-Step Procedures for Extrapolating Creep Strain Data – Conventional Method
  - C.2.2 Step-By-Step Procedures for Extrapolating Creep Strain Data – Stepped Isothermal Method (SIM)
- C.3 Determination of  $RF_{CR}$
- C.4 Estimation of Long-Term Creep Deformation
- C.5 Estimation of Creep Stiffness for Working Stress Design
- C.6 Evaluation of Product Lines

References

WSDOT Test Method No. 925, Appendix D

References



## WSDOT Standard Practice T 925

### *Standard Practice for Determination of Long-Term Strength for Geosynthetic Reinforcement*

#### Summary and Use of Standard Practice

Through this protocol, the long-term strength of geosynthetic reinforcements can be determined. This protocol contains test and evaluation procedures to determine reduction factors for installation damage, creep, and chemical/biological durability, as well as the method to combine these factors to determine the long-term strength. The long-term strength values determined from this protocol can be compared to the required design strengths provided in the contract for the geosynthetic structure(s) in question to determine if the selected product meets the contract requirements. This protocol can be used for initial product qualification or acceptance (e.g., for inclusion in the Qualified Products List), or for quality assurance (QA) to facilitate periodic review of products for which the long-term strength has been previously determined using this Standard Practice.

This protocol has been developed to address polypropylene (PP), polyethylene (PE or HDPE), and polyester (PET) geosynthetics. For other geosynthetic polymers (e.g., polyamide or PVA), the installation damage and creep protocols provided herein are directly applicable. While the chemical and biological durability procedures and criteria provided herein may also be applicable to other polymers (for example, hydrolysis testing as described in Appendix D is likely applicable to polyamide and PVA geosynthetics), additional investigation will be required to establish a detailed protocol and acceptance criteria for these other polymers. These other polymers may be considered for evaluation using this protocol once modifications to the chemical/biological durability aspects of this protocol have been developed and are agreed upon by the approval authority.

#### Abbreviations and Symbols

*AASHTO* = American Association of State Highway and Transportation Officials

$d_{50}$  = The grain size at 50% passing by weight for the backfill.

*HDPE* = High Density Polyethylene

*MARV* = The minimum average roll value for the geosynthetic, defined as two standard deviations below the mean for the product (i.e., 97.5% of all test results will meet or exceed the MARV). For practical purposes from the user's viewpoint, the average for a sample taken from any roll in the lot shipped to the job site should meet or exceed the MARV.

*MSE* = Mechanically Stabilized Earth

*PET* = Polyester

<b><i>PP</i></b>	=	Polypropylene
<b><i>QPL</i></b>	=	Qualified Products List
<b><i>RF</i></b>	=	Combined reduction factor to account for long-term degradation due to installation damage, creep, and chemical/biological aging
<b><math>RF_{CR}</math></b>	=	Strength reduction factor to prevent long-term creep rupture of the reinforcement
<b><math>RF_D</math></b>	=	Strength reduction factor to prevent rupture of the reinforcement due to long-term chemical and biological degradation
<b><math>RF_{ID}</math></b>	=	Strength reduction factor to account for installation damage to the reinforcement
<b><math>T_{al}</math></b>	=	The long-term tensile strength which will not result in rupture of the reinforcement during the required design life, calculated on a load per unit of reinforcement width basis
<b><math>T_{ult}</math></b>	=	The ultimate tensile strength of the reinforcement determined from wide width tensile tests
<b><i>UV</i></b>	=	Ultraviolet light
<b><i>WSDOT</i></b>	=	Washington State Department of Transportation

## Definitions

<i>Apertures</i>	The open spaces formed between the interconnected network of longitudinal and transverse ribs of a geogrid.
<i>Class 1 Structure</i>	Typically includes geosynthetic walls or slopes that support bridge abutments, buildings, critical utilities, or other facilities for which the consequences of poor performance or failure would be severe. In general, geosynthetic walls greater than 6 m (20 ft) in height and reinforced slopes greater than 9.2 m (30 ft) in height will be considered to be Class 1.
<i>Class 2 Structure</i>	All geosynthetic walls and slopes not considered to be Class 1.
<i>Confined Testing</i>	Geosynthetic testing in which the specimen is surrounded and confined by soil to simulate conditions anticipated for the geosynthetic in use.
Effective Design Temperature	The temperature that is halfway between the average yearly air temperature and the normal daily air temperature for the warmest month at the wall site.
<i>Hydrolysis</i>	The reaction of water molecules with the polymer material, resulting in polymer chain scission, reduced molecular weight, and strength loss.
<i>In-isolation Testing</i>	Geosynthetic testing in which the specimen is surrounded by air or a fluid (not soil).
<i>Installation Damage</i>	Damage to the geosynthetic such as cuts, holes (geotextiles only), abrasion, fraying, etc., created during installation of the geosynthetic in the backfill soil.



<i>Load Level</i>	For creep or creep rupture testing, the load applied to the test specimen divided by $T_{lot}$ , the short-term ultimate strength of the lot or roll of material used for the creep testing.
<i>Nonaggressive Environment</i>	For geosynthetic walls and slopes, soils which have a $d_{50}$ of 4.75 mm or less, a maximum particle size of 31.5 mm or less, a pH of 4.5 to 9, and an effective design temperature of 30° C or less.
<i>Oxidation</i>	The reaction of oxygen with the polymer material, initiated by heat, UV radiation, and possibly other agents, resulting in chain scission and strength loss.
<i>Post-consumer Recycled Material</i>	Polymer products sold to consumers which have been returned by the consumer after use of the products for the purpose of recycling.
<i>Product Line</i>	A series of products manufactured using the same polymer in which the polymer for all products in the line comes from the same source, the manufacturing process is the same for all products in the line, and the only difference is in the product weight/unit area or number of fibers contained in each reinforcement element.
<i>Sample</i>	A portion of material which is taken for testing or for record purposes, from which a group of specimens can be obtained to provide information that can be used for making statistical inferences about the population(s) from which the specimens are drawn.
<i>Specimen</i>	A specific portion of a material or laboratory sample upon which a test is performed or which is taken for that purpose.
<i>Survivability</i>	The ability of a geosynthetic to survive a given set of installation conditions with an acceptable level of damage.

### **Test Methods and Practices Used**

The following test methods and practices are used or referenced by Standard Practice T 925:

1. AASHTO Bridge Standard Specifications for Highway Bridges, 17th Edition, 2002
2. AASHTO Bridge LRFD Specifications for Highway Bridges, 3rd Edition, 2004 with current interims
3. ASTM D4354 Standard Practice for Sampling of Geosynthetics for Testing
4. ASTM D4873 –Standard Guide for Identification, Storage, and Handling of Geosynthetic Rolls and Samples
5. ASTM D5261 – Standard Test method for Measuring Mass per Unit Area of Geotextiles
6. ASTM D4595 – Standard Test Method for Tensile Properties of Geotextiles by the Wide-Width Strip Method
7. ASTM D 6637 – Standard Test Method for Determining Tensile Properties of Geogrids by the Single or Multi-Rib Tensile Method.

8. ASTM D-1248 – Standard Specification for Polyethylene Plastics Extrusion Materials for Wire and Cable
9. ASTM D-4101 – Standard Specification for Polypropylene Injection and Extrusion Materials
10. WSDOT Test Method T 926 – Geogrid Brittleness Test
11. ISO/DIS 10722-1 - Procedure for simulating damage during installation. Part 1: Installation in granular materials
12. ASTM D5818 – Standard Practice for Obtaining Samples of Geosynthetics from a Test Section for Assessment of Installation Damage
13. ASTM D2488 – Standard Practice for Description and Identification of Soils (Visual-Manual Procedure)
14. ASTM D1557 – Standard Test Methods for Laboratory Compaction Characteristics of Soil Using Modified Effort (56,000 ft-lbf/ft<sup>3</sup>)(2700 kN-m/m<sup>3</sup>)
15. AASHTO T96 - Resistance to Degradation of Small-Size Coarse Aggregate by Abrasion and Impact in the Los Angeles Machine
16. ASTM D6992 – Accelerated Tensile Creep and Creep-Rupture of Geosynthetic Materials Based on Time-Temperature Superposition Using the Stepped Isothermal Method
17. ASTM D5262 – Standard Test Method for Evaluating Unconfined Tension Creep Behavior of Geosynthetics
18. *ISO/FDIS 9080:2001* - Plastic piping and ducting systems – Determination of long-term hydrostatic strength of thermoplastics materials in pipe form by extrapolation.
19. ASTM D2837 – Standard Test Method for Obtaining Hydrostatic Design Basis for Thermoplastic Pipe Materials
20. ASTM D4355 – Standard Test Method for Deterioration of Geotextiles from Exposure to Ultraviolet Light and Water (Xenon-Arc Type Apparatus)
21. ASTM D4603 – Standard Test Method for Determining Inherent Viscosity of Poly(Ethylene Terephthalate) (PET) by Glass Capillary Viscometer
22. GRI-GG7 – Carboxyl End Group Content of PET Yarns
23. GRI-GG8 – Determination of the Number Average Molecular Weight of PET Yarns Based on a Relative Viscosity Value
24. ASTM D3045 – Standard Practice for Heat Aging of Plastics Without Load
25. ASTM D 3417-99 - Enthalpies of Fusion and Crystallization of Polymers by DSC
26. ENV ISO 13438:1999 - Geotextiles and Geotextile-Related Products - Screening Test Method for Determining the Resistance to Oxidation
27. ASTM D 3895 – Standard Test Method for Oxidative-Induction Time of Polyolefins by Differential Scanning Calorimetry
28. ASTM D 5885 – Standard Test Method for Oxidative Induction Time of Polyolefins by High-Pressure Differential Scanning Calorimetry

Per mutual agreement between the testing laboratory, the geosynthetic manufacturer, and the approval authority, "equivalent" ISO standards and practices may be used in lieu of ASTM, AASHTO, or GRI standards and practices where equivalent procedures are available.

### Data Requirements for Initial Product Acceptance

1. General Product Information (required for all geosynthetic reinforcement products):
  - a. Geosynthetic type and structure.
  - b. Spacing and dimensions of geogrid elements. The receiving laboratory should verify these dimensions upon receipt of the sample(s) using hand measurement techniques. This is especially critical for strength determination based on a single or limited number of ribs in the specimens tested.
  - c. Polymer(s) used for fibers, ribs, etc.
  - d. Polymer(s) used for coating, if present.
  - e. Roll size (length, width, and area).
  - f. Typical lot size.
  - g. Polymer source(s) used for product.
  - h. For HDPE and PP, primary resin ASTM type, class, grade, and category (for HDPE use ASTM D-1248, and for PP use ASTM D-4101).
  - i. For PET, minimum production number average molecular weight (ASTM D4603 and GRI:GG8) and maximum carboxyl end group content (GRI:GG7), with supporting test data. Information regarding the laboratory where the testing was conducted and date of testing shall also be provided.
  - j. % of post-consumer recycled material by weight.
  - k. Minimum weight per unit area for product (ASTM D5261).
  - l. MARV for ultimate wide width tensile strength (ASTM D4595 or ASTM D6637), with supporting test data. Information regarding the laboratory where the testing was conducted and date of testing shall also be provided.
  - n. UV resistance at 500 hours in weatherometer (ASTM D4355), with supporting test data (as a minimum, provide supporting data for one product in the product line, preferably the lightest weight product submitted in the product line). Information regarding the laboratory where the testing was conducted and date of testing shall also be provided.
  - o. In addition, to establish a baseline for quality assurance testing, oven aging tests conducted in accordance with ENV ISO 13438:1999, Method A (PP) or B (HDPE), for polyolefin geosynthetics shall be performed. As a minimum, the lightest weight product in the product line should be tested. Unexposed and post-exposure specimens shall be tested for tensile properties (ASTM D4595 or ASTM D6637).
  - p. for geogrids, evaluation of geogrid brittleness per WSDOT Test Method T 926.

2. Installation Damage Data Requirements (RF<sub>ID</sub>):

Installation damage testing and interpretation shall be conducted in accordance with Appendix A. As a minimum, for each product tested, the following information should be obtained:

- a. Date tests were conducted.
- b. Name(s), location(s), and telephone number(s) of laboratory(ies) conducting the testing and evaluation.
- c. Identify whether installation damage testing was conducted as a site specific evaluation for an actual construction project or was conducted as a non-site specific evaluation.
- d. Description of specific procedures used to conduct the installation damage testing, including installation procedures, sample size, method of specimen selection, sample removal procedures, etc. Identify any deviations in the installation procedures relative to typical installation practice in full scale structures, if the testing was not site specific.
- q. Photographs illustrating procedures used and the conditions at the time of the testing, if available.
- r. Measured mass/unit area per ASTM D5261 for the sample tested for installation damage and for the sample used to establish the undamaged strength. Also obtain product manufacturer Quality Control (QC) data on the uncoated product (i.e., “greige -good”) for the lot used for installation damage testing.
- g. Tensile test results for the product before exposure to installation conditions (i.e., virgin material), and whether both virgin and damaged samples were taken from the same roll of material, or just from rolls within the same lot of material.
- h. Tensile test results for specimens taken from the damaged material after installation.
- i. Tensile test results for both virgin and damaged specimens should include individual test results for each specimen, typical individual load-strain curves which are representative of the specimens tested, including associated calibration data as necessary to interpret the curves (curves in which strain and load/unit width are already calculated are preferred), the average value for each sample, the coefficient of variation for each sample, and a description of any deviations from the standard tensile test procedures required by Appendix A.
- j. Gradation curves for backfill material located above and below the installation damage geosynthetic samples, including the d<sub>50</sub> size, maximum particle size, and a description of the angularity of the soil particles per ASTM D2488, including photographs illustrating the soil particle angularity, if available. Also include LA Wear test results for the backfill material used.
- k. Photographs and/or a description of the type and extent of damage visually evident in the exhumed samples and specimens.
- l. RFID, and a description of the data interpretation method used to determine RF<sub>ID</sub> for each sample.

3. Creep Data Requirements ( $RF_{CR}$  and Creep Stiffness J):

Creep testing and interpretation shall be conducted in accordance with Appendices B and C. As a minimum, for each product tested, the following information should be obtained:

- a. Date tests were conducted.
- b. Name(s), location(s), and telephone number(s) of laboratory(ies) conducting the testing and evaluation.
- c. Photographs illustrating the creep testing equipment and procedures used, as available.
- d. Tensile test results for the product before creep testing (i.e., virgin material), and whether both virgin and creep tested samples were taken from the same roll of material, or just from rolls within the same lot of material.
- e. Tensile test results should include individual test results for each specimen, typical load-strain curves which are representative of the specimens tested, including associated calibration data as necessary to interpret the curves (curves in which strain and load/unit width are already calculated are preferred), the average value for each sample, the coefficient of variation for each sample, and a description of any deviations from the standard tensile test procedures required by Appendices B and C.
- f. Creep test procedures used, especially any deviations from the procedures required in Appendices B and C.
- g. If  $RF_{CR}$  is determined using data obtained in accordance with Appendix B, provide load and time to rupture for each specimen as a minimum; however, strain data as a function of time are desirable if available.
- h. If  $RF_{CR}$  is determined using data obtained in accordance with Appendix C, provide strain data as a function of time, and strain at beginning of tertiary creep (if rupture occurred), in addition to load applied and time to rupture (if rupture occurred), is required.
- j. Creep data plots should include both major and minor gridlines for ease in viewing and interpreting the data.
- k. If elevated temperature testing is conducted, creep data before and after time/load shifting, including shift factors used and a description of how the shift factors were derived, must be provided.
- l. Data illustrating the variability of the creep test environment, including temperature and humidity, during the creep test time period, or some assurance that the creep test environment was maintained within the variation of temperature prescribed within Standard Practice T 925, must be provided.
- m. A detailed description of creep extrapolation procedures used (i.e., step-by-step procedures and theoretical/empirical justification) if procedures other than those outlined in Appendices B and C are used.

- n. Description of statistical extrapolation procedures used in accordance with Appendices B and C, if statistical extrapolation is performed.
  - o. RFCR, and a description of how  $RF_{CR}$  was determined for each product.
  - p. In addition, regardless of which approach is used to determine  $RF_{CR}$ , creep strain data at a load level that results in a strain of 2% at approximately 1,000 hours shall be submitted to determine the low strain (i.e., 2%) creep stiffness at 1,000 hours and at the specified design life (typically 75 years) using isochronous curves determined in accordance with Appendix C.
  - q. For both creep rupture and low strain creep stiffness testing, if single rib, yarn, or narrow width specimens are used, 1,000 hour creep data in accordance with Appendices B and C that demonstrates the single rib, yarn, or narrow width test results are consistent with the results from multi-rib/wide width testing.
4. Long-Term Durability Data Requirements ( $RF_D$ ):

As a minimum, the durability test data requested in part (1), which include molecular weight and CEG for PET, oven aging tests for polyolefins, and UV resistance for all polymers, shall be provided.

If it is desired to submit detailed durability performance test data to justify a lower  $RF_D$ , or to allow use in environments classified as chemically aggressive, durability testing and interpretation shall be conducted in accordance with Appendix D, and, as a minimum, for each product tested, the following information should be obtained:

- a. Date tests were conducted.
- b. Name(s), location(s), and telephone number(s) of laboratory(ies) conducting the testing and evaluation.
- c. Photographs and drawings illustrating the durability testing equipment and procedures used, as well as a summary of the specific procedures used.
- d. Tensile test results for the product before durability testing (i.e., virgin material), and whether both virgin and durability test samples were taken from the same roll of material, or just from rolls within the same lot of material.
- e. Polymer characteristics for the lot or roll of material actually tested before long-term exposure in the laboratory, including, for example, molecular weight and carboxyl end group content for PET, melt flow index and OIT for polyolefins, percent crystallinity, SEM photographs of fiber surface, etc.

**Note 1:** Percent crystallinity can be determined using Differential Scanning calorimetry (DSC). An appropriate test method is ASTM D3417-99. By definition, crystallinity (X) is calculated as follows:

$$X = \frac{\Delta H}{\Delta H^\circ} \text{ (times 100 for \%)}$$

where:

$\Delta H$  is the latent heat under the DSC melt curve

$\Delta H^\circ$  is the latent heat for a 100% crystalline polymer

Temperature scan should start 10° C below, continue through, and stop 10° C above the melt range. Recommended test parameters are as follows:

Homo-Polymer	Sample Size (mg)	Melt Range (°C)	Latent Heat, $\Delta H^\circ$ (cal/gm)	DSC Scan Speed (°C/min)
HDPE	5	100-145	68.4	10
PP	7.5	100-165	45	10
PET	10	200-245	30	10

Other values of sample size, melt range, and DSC scan speed can be used with justification.

- f. Tensile test results for specimens taken for each retrieval from the incubation chambers.
  - g. Tensile test results, including tensile strength, strain at peak load, and 5 percent secant or offset modulus, for both virgin material and degraded material should include individual test results for each specimen, typical load-strain curves which are representative of the specimens tested, including associated calibration data as necessary to interpret the curves (curves in which strain and load/unit width are already calculated are preferred), the average value for each sample, the coefficient of variation for each sample, and a description of any deviations from the standard tensile test procedures required by Appendix D.
  - h. A detailed description of the data characterization and extrapolation procedures used, including data plots illustrating these procedures and their theoretical basis.
  - i. Results of any chemical tests taken (e.g., OIT or HPOIT, molecular weight, product weight/unit area, etc.), and any scanning electron micrographs taken, to verify the significance of any degradation in strength observed.
  - j. Results of biological degradation testing, if performed.
  - k. RFD, and a description of the method used to determine  $RF_D$  for the product.
5. Evaluation of Product Lines

If determining the long-term strengths for a product line, the data required under “General Product Information” must be obtained for each product. Product specific information for creep and durability must be obtained for at least one product in the product line to qualify the product line for Class 1 structures or aggressive environments, or in the case of Class 2 structures to allow the use of a total long-term strength reduction factor of less than 7 (see description of environment aggressiveness and Class 1 and Class 2 structures in “Determination Of Long-Term Geosynthetic Strength” later in this Standard Practice). Additional product specific information for creep and durability shall also be obtained for each product in the product line in accordance with Appendices B, C and D regarding use of long-term data for “similar” products. This data is to be used to determine long-term strengths for each product in the product line.

In general, product specific installation damage data must be obtained for each product in the line. However, it is permissible to obtain installation damage data for only some of the products in the product line if interpolation of the installation damage reduction factor between products is feasible. Interpolation of the product specific installation damage reduction factor  $RF_{ID}$  between tested products can be based on the weight per unit area or undamaged tensile strength of each product, provided that the progression of weight per unit area or tensile strength as compared to the progression of  $RF_{ID}$  for each tested product is consistent. For coated geogrids, the weight of coating placed on the fibers or yarns may influence the amount of installation damage obtained (Sprague, et al., 1999). In that case, the installation damage reduction factor may need to be correlated to the coating weight instead. If it is determined that the  $RF_{ID}$  values obtained for a product line are not correlated with product weight per unit area, undamaged tensile strength, coating weight, or some other product parameter, and the variance of  $RF_{ID}$  between any two products in the product line is 0.1 or more, then each product in the product line shall be tested.

### Determination of Long-term Geosynthetic Strength for Initial Product Acceptance

#### 1. Calculation of Long-Term Strength

Reinforcement elements in MSE walls and reinforced slopes should be designed to have a durability to ensure a minimum design life of 75 years for permanent structures in accordance with AASHTO (2002, 2004). For ultimate limit state conditions:

$$T_{al} = \frac{T_{ult}}{RF} \quad (1)$$

where:

$$RF = RF_{ID} \times RF_{CR} \times RF_D \quad (2)$$

- $T_{al}$  = The long-term tensile strength that will not result in rupture of the reinforcement during the required design life, calculated on a load per unit of reinforcement width basis
- $T_{ult}$  = the ultimate tensile strength (MARV) of the reinforcement determined from wide width tensile tests
- $RF$  = a combined reduction factor to account for potential long-term degradation due to installation damage, creep, and chemical/biological aging
- $RF_{ID}$  = a strength reduction factor to account for installation damage to the reinforcement
- $RF_{CR}$  = a strength reduction factor to prevent long-term creep rupture of the reinforcement
- $RF_D$  = a strength reduction factor to prevent rupture of the reinforcement due to chemical and biological degradation

See Appendices A through D for protocols to use to determine RF from product specific data. Unless otherwise indicated in the contract specifications for a given project, the design temperature used to determine RF and  $T_{al}$  from product specific data shall be assumed to be 20° C (68° F).



The value selected for  $T_{ult}$  is the minimum average roll value (MARV) for the product to account for statistical variance in the material strength.  $T_{ult}$  should be based on a wide width tensile strength (i.e., ASTM D4595 for geotextiles or ASTM D6637 for geogrids). Other sources of uncertainty and variability in the long-term strength include installation damage (Appendix A), creep extrapolation (Appendices B and C), and chemical degradation (Appendix D). It is assumed that the observed variability in the creep rupture envelope is 100% correlated with the short-term tensile strength, as the creep strength is typically directly proportional to the short-term tensile strength within a product line (see Appendix B and Note 7 in Appendix B if this is not the case). Therefore, the MARV of  $T_{ult}$  adequately takes into account that source of variability. For additional discussion of this issue, see Note 2 below.

**Note 2:** *The product strength variability is not taken into account by using the creep limited strength,  $T_p$ , directly or in normalizing  $T_1$  by  $T_{lot}$  (see Appendix B).  $T_1$  only accounts for extrapolation uncertainty. Furthermore,  $T_{lot}$  is specific to the lot of material used for the creep testing. Normalizing by  $T_{lot}$  makes the creep reduction factor  $RF_{CR}$  applicable to the rest of the product line, as creep strength is typically directly proportional to the ultimate tensile strength, within a product line. As shown below, it is not correct to normalize the creep strength  $T_1$  using  $T_{ult}$ , the MARV of the tensile strength for the product, nor is it correct to use  $T_1$  directly in the numerator to calculate  $T_{al}$ .*

$$RF_{CR} = \frac{T_{lot}}{T_1} \neq \frac{T_{ult}}{T_1} \quad \text{and} \quad T_{al} \neq \frac{T_1}{RF_{ID} \times RF_D}$$

In the former case, the creep strength is not indexed to the actual tensile strength of the material used in the creep testing, and since there is a 50% chance that  $T_{ult}$  will be less than or equal to  $T_{lot}$ , using  $T_{ult}$  in this case would result in an unconservative determination of  $RF_{CR}$ . In the latter case, where  $T_1$  is used directly as a creep reduced strength, the product strength variability is not taken into account, since  $T_1$  is really a mean creep strength. Hence,  $RF_{CR}$  must be determined as shown in Equation B.4-1 (see Appendix B), and the MARV must be used for  $T_{ult}$  when determining  $T_{al}$ . Note that the use of the MARV for  $T_{ult}$  may not fully take into account the additional variability caused by installation damage. For the typical degree of installation damage observed in practice, this additional variability is minor and can be easily handled through the overall safety factor used in design of reinforced structures. For durability ( $RF_D$ ), additional variability does not come into play if a default reduction factor is used. If a more refined durability analysis is performed, additional variability resulting from chemical degradation may need to be considered.

The type and amount of data to be obtained, and the approach used to determine the long-term design strength, will depend on the geosynthetic wall or reinforced slope class and the aggressiveness of the environment.

## 2. Wall or Slope Class

The class of a given geosynthetic structure will be identified in the contract specifications. A Class 1 geosynthetic wall or reinforced slope typically includes walls or slopes that support bridge abutments, buildings, critical utilities, or other facilities for which the consequences of poor performance or failure would be severe. Examples of severe consequences include serious personal injury, loss of life, or significant property damage. Cost and impact to the public if a poorly performing wall or slope must be repaired or replaced may also be considered in the determination of wall or slope class. In general, geosynthetic walls greater than 6 m (20 ft) in height and reinforced slopes greater than 9.2 m (30 ft) in height will be considered to be Class 1. All other geosynthetic walls and reinforced slopes will in general be considered to be Class 2. The specific application of geosynthetic structure class shall be carried out in accordance with AASHTO (2002, 2004) and other requirements of the approval authority.

## 3. Environment Aggressiveness

A nonaggressive environment is defined based on soil gradation and particle characteristics, chemical properties of the environment, and site temperature. Normally, the backfill pH will be the key chemical property that will affect the chemical aggressiveness of the geosynthetic environment. Soil gradation and particle characteristics primarily affect potential high  $RF_{ID}$  values, chemical properties affect the potential for high  $RF_D$  values, and temperature affects potential for high  $RF_D$  and high  $RF_{CR}$  values. The aggressiveness of the soil gradation will depend on the distribution, the maximum size, the angularity, and the durability of the soil particles. In general, the more angular the soil, the more uniform its gradation, the greater the maximum particle size, and the more durable the particles, the more aggressive the soil is with regard to potential for installation damage. Installation damage for geosynthetic reinforcement has been approximately correlated to the  $d_{50}$  size of the soil, and the  $d_{50}$  size can be used as a basis to interpolate to a specific soil gradation using test results at other gradations (Elias, 2000). However, other gradation characteristics may need to be considered to more accurately interpolate to a specific soil gradation and angularity. While installation damage can be evaluated for the anticipated soil gradation and characteristics, it is generally undesirable to use soils and associated installation conditions that result in a  $RF_{ID}$  value that is greater than approximately 1.7 due to the likelihood of excessive variability in the results. The decision as to what gradation characteristics are to be considered too aggressive shall be made by the approval authority.

Regarding chemical properties of the environment surrounding the geosynthetic in the wall or slope, the pH shall be between 4.5 and 9 to be considered nonaggressive. This applies both in the reinforced backfill and at the back of the face of walls.

Regarding temperature, the effective design temperature at the wall or slope site shall be less than 30° C (85° F) for the environment to be considered nonaggressive. In all but the most southerly tier of states in the USA, all wall and slope sites are anticipated to have an effective design temperature that is below 30° C.

For most soil conditions in the USA, the environment will likely be chemically nonaggressive. A possible exception to this is immediately behind a concrete wall face, where pH levels could possibly be elevated above a pH of 9. However, recent research has indicated that for well drained backfills, the pH adjacent to a concrete face stays below 9 in the long-term (Koerner, et al., 2001, Koerner, et al., 2002). In any case, the long-term strength determination must account for the environment at the face. However, there are specific geological regions in the USA that are more likely to have chemically aggressive conditions as described in Elias (2000). Examples include salt affected soils in the arid western (especially southwest) regions of the USA, acid-sulphate soils that are commonly found in the Appalachian region of the USA, and calcareous soils commonly found in Florida, Texas, New Mexico, and many western states.

The wall or slope contract specifications will identify if the environment is anticipated to be aggressive and the reason for the aggressive environment designation (i.e., backfill gradation, site chemistry, or site temperature). If aggressive conditions are not identified in the contract specifications, and the contract specifications provide soil chemical criteria that are consistent with nonaggressive conditions as described herein, the environment should be considered to be nonaggressive to determine the longterm strength. However, the backfill should be tested prior to use to verify that it is nonaggressive.

4. Requirements for Class 1 Walls and Slopes to Determine  $T_{al}$

$RF_{ID}$  and  $RF_{CR}$  shall be determined from product specific data for all geosynthetics used in Class 1 walls and slopes. See submission requirements for installation damage and creep data provided in this document. The product specific data for these reduction factors shall be interpreted/extrapolated in accordance with Appendices A, B, and C.  $RF_D$  shall be determined from long-term product specific data, or a default value may be used as described below. See submission requirements for durability data provided herein. Long-term product specific data for  $RF_D$  should be interpreted in accordance with Appendix D. If adequate long-term durability data is not available, a default reduction factor for  $RF_D$  may be used if the environment is nonaggressive and if the product meets the minimum polymer and physical property requirements provided in Table 1. In this case, a default value for  $RF_D$  of 1.3 may be used for PET, HDPE, and PP geosynthetics.

**Note 3:** *The default value for  $RF_D$  of 1.3, which can be used for products that meet the minimum property requirements in Table 1, was determined based on FHWA (1997) and Elias, et. al. (1997) and in consideration of the relatively cool climate which exists in the state of Washington, where effective design temperatures are always less than 20° C (68° F) and are likely to be on the order of 10° C (50° F) or less. A higher default value of 1.5 for products which meet the property requirements in Table 1 may be desirable for more temperate climates which still meet the requirements for a nonaggressive environment, especially to address polyolefin oxidative degradation, as the potential for this type of degradation, even for products which meet the property requirements in Table 1, becomes more uncertain at higher temperatures due to the lack of protocols which can accurately identify the amount or effectiveness of end use antioxidants present. The UV resistance criteria provided in Table 1 only provides a rough indication of the effectiveness of end use antioxidants in polyolefins (see additional commentary following Table 1).*

If the environment is identified as aggressive due to the chemical regime or due to temperature, or if the geosynthetic product does not meet the requirements in Table 1, default reduction factors may not be used for  $RF_D$ . For chemically aggressive or elevated temperature environments,  $RF_D$  must be determined based on long-term product specific data for an environment that is as or more aggressive than the project specific environment in question. Aggressive environments need to be addressed in the product submittal only if specifically requested by the contracting agency or the geosynthetic supplier. Once the appropriate reduction factors are established, the long-term geosynthetic strength is determined using Equations 1 and 2, or as determined in Note 7 of Appendix B.

5. Requirements for Class 2 Walls and Slopes to Determine  $T_{al}$

The strength reduction factors  $RF_{ID}$ ,  $RF_{CR}$ , and  $RF_D$  may be determined based on product specific data as described for Class 1 walls and slopes. If long-term product specific data is not available, the environment is nonaggressive, and the product meets the minimum requirements provided in Table 1, a default value of 7 may be used for  $RF$  to determine the long-term strength of the product in accordance with Equations 1 and 2.

6. Minimum Polymer and Physical Property Requirements to Allow Use of Default Reduction Factors for  $RF$  and  $RF_D$  in Nonaggressive Environments

If a default reduction factor is to be used, geosynthetic products that are likely to have good resistance to installation stresses and to long-term chemical degradation are required to minimize the risk of significant long-term degradation. The physical and polymer material requirements provided in Table 1 must be met if detailed product specific data as described in Appendices A, B, C and/or D is not obtained. Polymer materials not meeting the requirements in Table 1 could be used if detailed product specific data extrapolated to the design life intended for the structure (see Appendices A, B, C and D) is provided.

**Table 1**

Minimum Requirements for Geosynthetic Products to Allow Use of Default Reduction Factor for Long-Term Degradation.

Polymer Type	Property	Test Method	Criteria to Allow Use of Default RF*
PP and HDPE	UV Oxidation Resistance	ASTM D4355	Min. 70% strength retained after 500 hrs in weatherometer
PET	UV Oxidation Resistance	ASTM D4355	Min. 50% strength retained after 500 hrs in weatherometer if geosynthetic will be buried within one week, 70% if left exposed for more than one week.
PP and HDPE	Thermo- Oxidation Resistance	ENV ISO 13438:1999, Method A (PP) or B (HDPE)	Min. 50% strength retained after 28 days (PP) or 56 days (HDPE)
PET	Hydrolysis Resistance	Inherent Viscosity Method (ASTM D4603 and GRI Test Method GG8), or Determine Directly Using Gel Permeation Chromatography	Min. Number Average Molecular Weight of 25,000
PET	Hydrolysis Resistance	GRI Test Method GG7	Max. Carboxyl End Group Content of 30
All Polymers	Survivability	<sup>1</sup> Weight per Unit Area (ASTM D5261)	<sup>1</sup> Min. 270 g/m <sup>2</sup>
All Polymers	% Post-Consumer Recycled Material by Weight	Certification of Materials Used	Maximum of 0%

\*Polymers not meeting these requirements may be used if product specific test results obtained and analyzed in accordance with Appendices A, B, C, and D are provided.

<sup>1</sup>Alternatively, a default  $RF_D = 1.3$  may be used if product specific installation damage testing is performed and it is determined that  $RF_{ID}$  is 1.7 or less, and if the other requirements in Table 1 are met.

**Note 4:** *The requirements provided in Table 1 utilize currently available index tests and are consistent with current AASHTO design specifications (AASHTO, 2004, 2002), with the exception of the oven aging test, which is a new requirement. These index tests can provide an approximate measure of relative resistance to long-term chemical degradation of geosynthetics. Values selected as “minimum” criteria to allow use without additional long-term testing are based on values for such properties reported in the literature. These values are considered indicative of good long-term performance or represent a readily available current standard within the industry that signifies that a product has been enhanced for long-term environmental exposure.*

*Though UV resistance (i.e., photo-oxidation resistance) is not a direct indicator of thermo-oxidation resistance for polypropylene and polyethylene, both photo-oxidation and thermo-oxidation are oxidation reactions, and many UV inhibitors also provide at least some long-term resistance to thermo-oxidation (Van Zanten, 1986). Regarding polyester requirements, maximum resistance to strength losses due to hydrolysis can be obtained by formulating to high molecular weights (> 25,000) and low (i.e., < 30) Carboxyl End Group numbers (Risseeuw and Schmidt, 1990; FHWA, 1997; and Elias, et. al., 1997).*

*Minimum weight/area requirements are based on the results of numerous exhumations of geosynthetics, in which it was determined that installation damage was minimal for products with a minimum of weight of 270 g/m<sup>2</sup> (8 oz/yd<sup>2</sup>) (Koerner and Koerner, 1990; Allen, 1991). This roughly corresponds to a Class 1 geotextile as specified in AASHTO M-288.*

*There is little long-term history or even laboratory data regarding the durability of geosynthetics containing a significant percentage of recycled material. Therefore, their potential long-term performance is unknown, and it is recommended that long-term data be obtained for products with significant recycled material to verify their performance before using them.*

## **Quality Assurance Requirements for Products that have been Through Initial Acceptance**

### **1. Data Verification Requirements**

The following information about each product shall be submitted for verification purposes:

- a. Geosynthetic type and structure.
- b. Spacing and dimensions of geogrid elements. The receiving laboratory should verify these dimensions upon receipt of the sample(s) using hand measurement techniques. This is especially critical for strength determination based on a single or limited number of ribs in the specimens tested.
- c. Polymer(s) used for fibers, ribs, etc.
- d. Polymer(s) used for coating, if present.
- e. Roll size (length, width, and area).
- f. Typical lot size.
- g. Polymer source(s) used for product.
- h. For HDPE and PP, primary resin ASTM type, class, grade, and category (for HDPE use ASTM D-1248, and for PP use ASTM D-4101).
- j. % post-consumer recycled material by weight.
- k. Minimum weight per unit area for product (ASTM D5261).
- l. MARV for ultimate wide width tensile strength (ASTM D4595 or ASTM D6637).

## 2. Quality Assurance (QA) Testing Approach

Results from index and performance tests will be compared to baseline index or performance test results obtained for initial product acceptance purposes. If the QA test results are within acceptable tolerances relative to the baseline results, the acceptance status of the product or product line will be maintained (e.g., the product will continue to be listed in the QPL). Re-testing must be done if there is any change in the product. If changes in the product identified through product data verification as described in part 1 above or identified through other means are such that the validity of the last complete assessment for initial acceptance is too questionable, a complete assessment of the product or product line in accordance with this Standard Practice instead of just a QA evaluation may be required by the approval authority to maintain acceptance status.

## 3. Quality Assurance (QA) Sampling

All materials and/or products to be tested will be furnished by the manufacturer/supplier at no cost to the review/approval authority. Samples will be selected for testing by Department of Transportation personnel or designated parties. As a minimum, the following shall be obtained:

- a geosynthetic product sample of sufficient size to accommodate all of the specified testing;
- information showing the manufacturer's name and description of product: (style, brand name, etc.);
- product roll and lot number;
- a sample of the polymer component(s) in sufficient quantity to conduct the specified polymer tests.

All samples for the specified QA testing shall be from the same roll of material for each product tested.

## 4. Quality Assurance (QA) Testing

Short-term ultimate tensile strength test results, and QA test results to verify the correctness of  $RF_{ID}$ ,  $RF_{CR}$ , and  $RF_D$  determined from initial product acceptance testing, shall be obtained. Short-term tensile strength shall be determined in accordance with ASTM D4595 for geotextiles and ASTM D6637 for geogrids. QA testing required to verify the correctness of  $RF_{ID}$ ,  $RF_{CR}$ , and  $RF_D$  determined from initial product acceptance testing is as follows:

### A. Installation Damage Testing

For installation damage evaluation, a field exposure trial conducted in accordance with Appendix A shall be conducted for the product in the product line with the highest  $RF_{ID}$  from the initial product acceptance testing using the soil with a  $d_{50}$  size which is equal to or larger than a  $d_{50}$  size of 4.75 mm, or other  $d_{50}$  size as determined by the approval authority, and the aggregate shall have a maximum LA Wear percent loss of 35 percent. The  $d_{50}$  size, angularity, and durability of the selected backfill should be consistent with the  $d_{50}$  size used for initial product acceptance (preferably, the same material should be used for both the acceptance testing and the quality assurance testing, if possible). Alternatively, reduced scale laboratory installation

damage tests conducted in accordance with ISO/DIS 10722-1 may be used. In this case, these laboratory installation damage tests must also be conducted during initial product acceptance testing to establish a baseline value. The ultimate tensile strength of the lot or roll of material used in the installation damage testing obtained in accordance with ASTM D4595 or ASTM D6637 using the multi-rib procedure (or ISO 10319 if ISO/DIS 10722-1 is used) shall be obtained to normalize the installation damage test results in accordance with Appendix A. If it was determined during the initial product acceptance testing, for coated geogrids, that the installation damage factor was not a function of product weight or tensile strength, the coating weight shall also be evaluated. In this case, the mass/unit area of the sample tested shall be determined in accordance with ASTM D5261. The coating weight can then be established using the lot specific mass/unit area of the uncoated product from product manufacturer Quality Control (QC) data. The information required in part 2 of “Data Requirements for Initial Product Acceptance” as it applies to the QA testing shall be obtained and included in the test report for this QA testing.

#### B. Creep Testing

For creep rupture evaluation, a minimum of three creep-rupture points shall be obtained using SIM (ASTM D6992) or conventional ASTM D5262 tests (for which elevated test temperatures may be employed to accelerate creep – see Appendix B) at a load level established at the time of initial product acceptance testing that corresponds to a minimum rupture time of 100,000 hours at the reference temperature. If elevated temperature conventional creep testing using ASTM D5262 is performed, the shift factors obtained from the conventional creep testing for the temperatures used in the QA testing conducted for initial product acceptance shall be used to extrapolate the test data to the reference temperature. A fourth SIM test (or conventional ASTM D5262 test conducted at the reference temperature) shall be performed at a load level established at the time of initial product acceptance testing that corresponds to a minimum rupture time of 500 hours at the reference temperature. Note that if initial product acceptance was based on Appendix C (creep strain testing), creep strain measurements must be obtained, and the load levels selected for the QA creep testing should be equal to the load level that results in reaching a specified strain using the creep data used to establish the initial product acceptance envelope (see Appendix C, Section C.2.2) at 500 hours (one test) and 50,000 hours (three tests), at the reference temperature. The strain level used for this purpose shall preferably be 5 to 10% or more, and be as close to the instability limit strain as possible while catching as many of the creep curves as possible. See Section 5(d) for additional explanation.

For creep stiffness evaluation, if the product acceptance testing conducted indicates that the creep is log linear at the low strain levels tested, short-term (1,000 second) ramp and hold (R+H) tests as described in ASTM D6992 may be used and extrapolated to 1,000 hours in lieu of 1,000 hour creep tests. A minimum of two R+H tests shall be conducted for one product in the product line at the load level in which 2 percent strain at 1,000 hours was achieved in the product acceptance testing. If the product acceptance testing indicates that the creep is not log linear at the low strain level tested, then a minimum of two full 1,000 hour creep tests must be conducted at that load level. These tests shall be conducted on the same width specimens as was used for the product acceptance creep stiffness testing.



If SIM is used for this creep rupture testing, it shall have been demonstrated for the initial acceptance testing that the reduced specimen width typically used for SIM testing does not have a significant effect on the creep rupture results, and provided that the validity of SIM for the product through comparison of SIM data with “conventional” creep rupture data was established for the initial product acceptance testing.

The ultimate tensile strength of the lot or roll of material used in the creep testing obtained in accordance with ASTM D4595 or ASTM D6637 shall be obtained to normalize the creep rupture loads in accordance with Appendix B or C. The information required in part 3 of “Data Requirements for Initial Product Acceptance” as it applies to the QA testing shall be obtained and included in the test report for this QA testing.

*Note 5: If “conventional” creep testing is performed for QA purposes, it is assumed that the product has not changed relative to what was tested for initial product acceptance purposes, thereby allowing the assumption to be made that the shift factors obtained through the initial product acceptance testing are valid for the QA testing. Requiring new “conventional” creep test shift factors to be re-established would result in the need to fully repeat the test program for the initial product acceptance, which would not be practical for QA purposes. Regarding the fourth creep test data point, the requirement to use only data obtained at the reference temperature if “conventional” creep testing is performed provides a second check that eliminates the need for this shift factor assumption and any inaccuracies associated with that assumption.*

### C. Durability Testing

If only index durability testing was conducted to allow use of a default value for  $RF_D$  for the initial product acceptance testing, only index durability testing need be conducted for QA purposes. In this case, durability testing for QA purposes shall consist of the determination of molecular weight based on GRI-GG7 and carboxyl end group content based on GRI-GG8 for polyesters, UV resistance based on ASTM D4355 for polyolefins and PET's), and an oven aging exposure test per ENV ISO 13438:1999 for polyolefin geosynthetics. Regarding the oven aging test, control and post-exposure specimens shall be tested for tensile properties (ASTM D4595 or ASTM D6637). The results of this oven aging testing will be used only to compare a product with itself, and to meet the minimum requirements in Table 1. In addition, geogrid brittleness shall be evaluated per WSDOT Test Method T 926.

If long-term performance durability testing was conducted to justify the use of a lower  $RF_D$  or to justify use in aggressive environments for initial product acceptance, a minimum of five specimens shall be exposed to the most aggressive environment used in the initial product acceptance testing at the highest temperature tested, for a minimum of 2,000 hours. These specimens, and unexposed specimens from the same roll of material, shall be tested for tensile properties (ASTM D4595 or ASTM D6637). In addition, for polyolefins, either oxidative induction time per ASTM D 3895 or high pressure oxidative induction time per ASTM D 5885 shall be conducted for each specimen tested (before and after exposure), and for PET's, molecular weight (ASTM D4603 and GRI:GG8) and specimen weight per unit area (ASTM D5261) shall be conducted for each specimen tested (before and after exposure).

## 5. Quality Assurance (QA) Criteria for Comparison to Initial Product Acceptance Test Results

The acceptability of the QA test results to allow a product or product line to maintain its prior acceptance status is established based on the statistical significance, or lack thereof, of the difference between the QA test results and the initial product acceptance test results. The criteria and methods for determining the statistical significance between the QA and initial product acceptance test results are as follows:

### A. Short-term Index Tensile Testing

For wide width tensile strength, the mean of the test results for the sample for each product tested shall be greater than or equal to the MARV reported for the product.

### B. Installation Damage Testing

If the mean of the average strength of the sample after damage as a percent of the undamaged strength is less than the average value obtained for the same product and condition during the product acceptance phase, the maximum difference between the two means shall be no greater than what is defined as statistically insignificant based on a one-sided student-t distribution at a level of significance of 0.05. In this case,  $t$  is determined as follows:

$$t_{\alpha/2, n_1+n_2-2} = \frac{(\bar{P}_1 - \bar{P}_2) - \delta}{\sqrt{(n_1-1)s_1^2 + (n_2-1)s_2^2}} \sqrt{\frac{n_1 n_2 (n_1 + n_2 - 2)}{(n_1 + n_2)}}$$

where,

$t_{\alpha/2, n_1+n_2-2}$	=	value of the t-distribution for the installation damage samples
$\bar{P}_1$	=	the mean of the strength retained after installation damage (i.e., $T_{\text{dam}}/T_{\text{lot}}$ ) obtained for initial product acceptance
$\bar{P}_2$	=	the mean of the strength retained after installation damage (i.e., $T_{\text{dam}}/T_{\text{lot}}$ ) obtained for QA testing
$\delta$	=	the difference in the means for the populations corresponding to the sample means $\bar{P}_1$ and $\bar{P}_2$ (assumed equal to zero for this test)
$s_1$	=	the standard deviation corresponding to $\bar{P}_1$
$s_2$	=	the standard deviation corresponding to $\bar{P}_2$
$n_1$	=	the number of data points corresponding to $\bar{P}_1$
$n_2$	=	the number of data points corresponding to $\bar{P}_2$

$t_{\alpha/2, n_1+n_2-2}$  calculated using Equation 3 shall be no greater than  $t$  determined from the applicable Student  $t$  table (or from the Microsoft EXCEL function  $TINV(\alpha, n-2)$ ) at  $\alpha = 0.05$  and  $n_1+n_2-2$  degrees of freedom. If this is not true, the difference between  $\bar{P}_1$  and  $\bar{P}_2$  is determined to be statistically significant, and  $\bar{P}_1 > \bar{P}_2$ , two additional samples from the same installation condition shall be tested and  $\bar{P}_2$  recalculated and statistically compared to  $\bar{P}_1$ . If the QA test results are still too low, a full installation damage study for initial product acceptance must be completed in accordance with Appendix A, and new values of  $RF_{ID}$  established.

### C. Creep Rupture Testing for Prediction of Creep Limit

For creep evaluation, the four creep-rupture points, one at a load level that results in an approximate rupture time, after time shifting, of 500 hours and three at a load level that results in an approximate rupture time, after time shifting, of 100,000 hours on the rupture envelope obtained for initial product acceptance purposes shall be compared to the creep data obtained for initial product acceptance purposes. The log of the rupture time for each of these four rupture points shall be equal to or greater than the 95% lower prediction limit of the variable, log time, established by the Student's *t* test of the original product acceptance data set.

The prediction limit for the regression performed for initial product acceptance is given by (Wadsworth, 1998):

$$(4) \log t_L = \log t_{reg} - \left[ t_{\alpha/2, n-2} \sqrt{1 + \frac{1}{n} + \frac{(P - \bar{P})^2}{\sum (P_i - \bar{P})^2}} \right] \times \sigma$$

and

$$\sigma = \sqrt{\frac{\sum [\log t_i - \overline{\log t}]^2 - \frac{\left\{ \sum [(P_i - \bar{P})(\log t_i - \overline{\log t})] \right\}^2}{\sum (P_i - \bar{P})^2}}{n - 2}} \quad (5)$$

where:

- $\log t_L$  = lower bound prediction limit
- $t_{reg}$  = time corresponding to the load level from the initial product acceptance creep rupture envelope at which QA creep tests were performed (e.g., at 500 and 100,000 hrs after time shifting)
- $t_{\alpha/2, n-2}$  = value of the *t* distribution determined from applicable Student *t* table (or from the Microsoft EXCEL function TINV( $\alpha, n-2$ )) at  $\alpha/2 = 0.05$  and  $n-2$  degrees of freedom (this corresponds to the 95% one-sided prediction limit)
- $n$  = the number of rupture or allowable run-out points in the original test sample (i.e., for initial product acceptance)
- $P$  = load level obtained at  $t_{reg}$  from the regression line developed from the initial product acceptance testing
- $\bar{P}$  = the mean rupture load level for the original test sample (i.e., all rupture or run-out points used in the regression to establish the rupture envelope for initial product acceptance)
- $P_i$  = the rupture load level of the *i*'th point for the rupture points used in the regression for establishing the rupture envelope for initial product acceptance
- $\log t$  = the mean of the log of the rupture time for the original test sample (i.e., all rupture or run-out points used in the regression to establish the rupture envelope for initial product acceptance)
- $t_i$  = the rupture time of the *i*'th point for the rupture points used in the regression for establishing the rupture envelope for initial product acceptance

The comparison between the QA test results and the initial product acceptance test results is illustrated conceptually in Figure 1. Once  $\log t_L$  has been determined at each specified load level, compare this value to the  $\log$  rupture time (i.e.,  $\log t_{QA}$ ) obtained for each QA creep rupture test at the specified load level (e.g., 500 and 100,000 hours). If  $\log t_{QA} < \log t_L$  for any of the QA creep rupture test results, perform two additional tests at the load level  $P$  for the specified  $t_{reg}$  where this QA criteria was not met and compare those results to  $\log t_L$ . If for these two additional tests this criterion is not met, perform adequate additional creep rupture testing to establish a new rupture envelope for the product in accordance with initial product acceptance requirements (Appendix B). This new rupture envelope will form the baseline for any future QA testing.

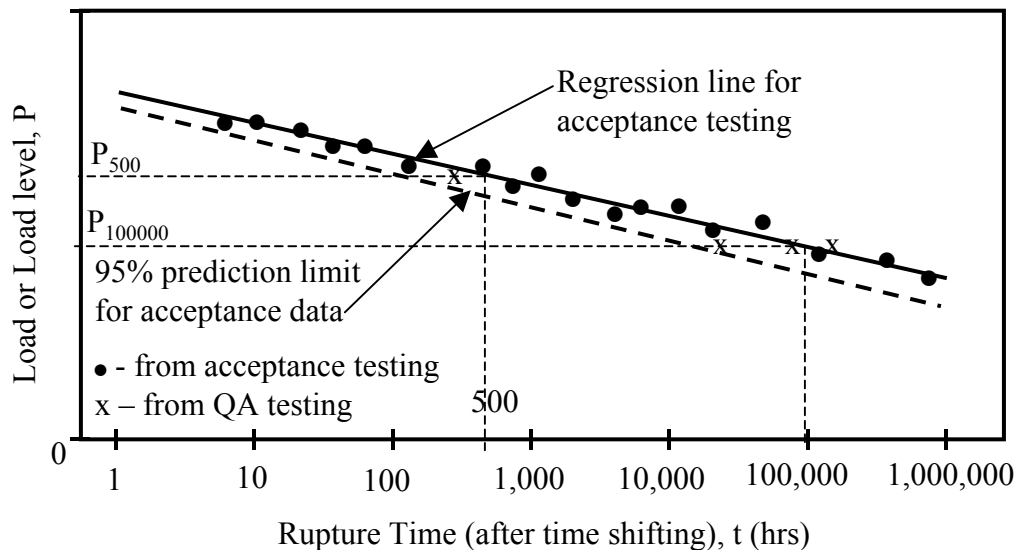

Figure 1. Conceptual illustration of the comparison of QA creep rupture test results to initial product acceptance creep rupture test results.

#### D. Creep Strain Testing for Prediction of Creep Limit

The comparison between the creep data obtained for the initial product acceptance testing and the QA creep data shall be performed at a specified strain. The specified strain will depend on the strains observed in all of the creep tests (initial product acceptance and QA). Select a strain that will intercept all of the creep curves as much as possible. Preferably, the strain level should be approximately 5 to 10% or more, and as close to the instability limit strain as possible. Where the selected strain level intersects each creep curve, determine the time required to reach the specified strain. Plot the load level as a function of the logarithm of time to reach the specified strain for the initial product acceptance data, and perform a regression for this data set. The log times to the specified strain level for the QA creep data shall be determined at a load level that corresponds to 500 hours and 50,000 hours on the initial product acceptance creep envelope. This is illustrated conceptually in Figure 2. The log of the time to reach the same specified strain for each of the four QA creep data points shall be equal to or greater than the 95% lower prediction limit of the variable, log time, established by the Student's  $t$  test of the original product acceptance data set, using Equations 4 and 5 (see part "c" above).

Once  $\log t_L$  has been determined at each specified load level, compare this value to the log time to reach the specified strain (i.e.,  $\log t_{QA}$ ) obtained for each QA creep test at the specified load level (e.g., 500 and 50,000 hours). If  $\log t_{QA} < \log t_L$  for any of the QA creep rupture test results, perform two additional tests at the load level  $P$  for the specified  $t_{reg}$  where this QA criteria was not met and compare those results to  $\log t_L$ . If for these two additional tests this criterion is not met, perform adequate additional creep testing to establish a new creep stiffness curve for the product in accordance with initial product acceptance requirements (Appendix C). This new creep stiffness curve will form the baseline for any future QA testing.

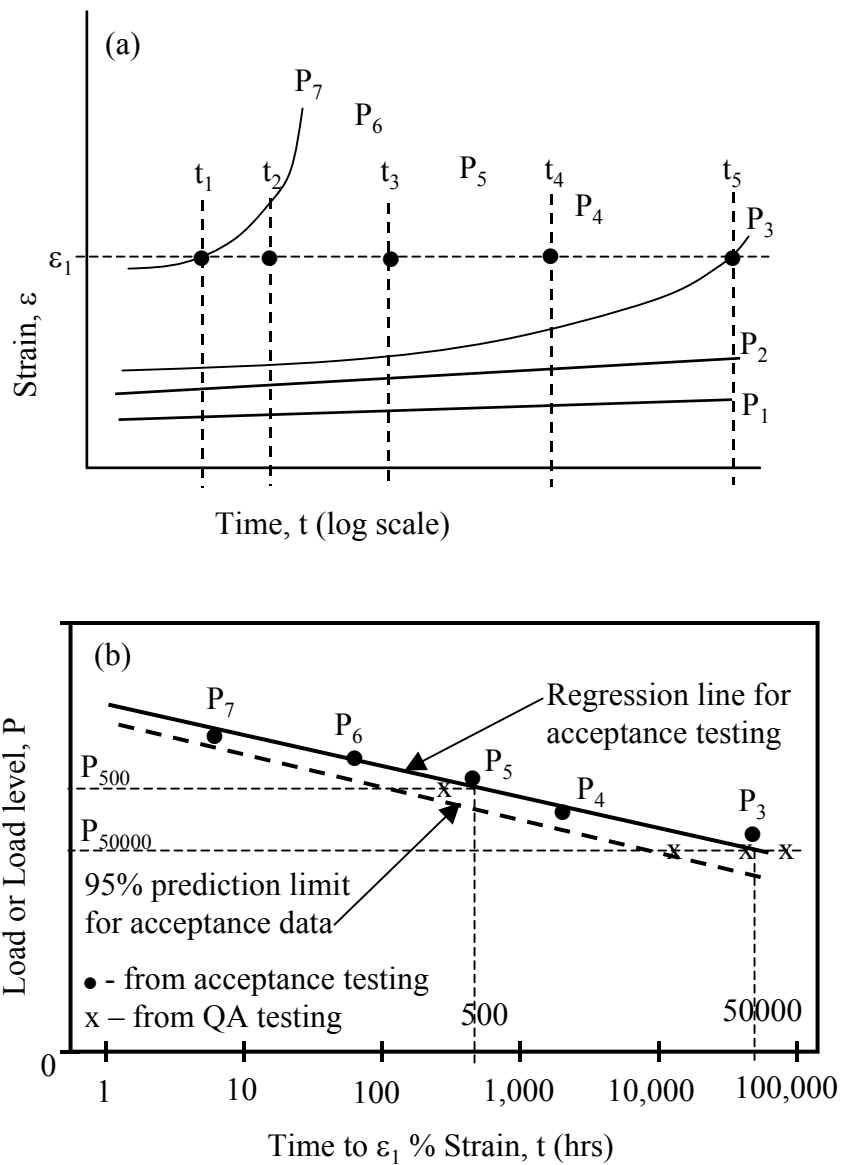

Figure 2. Conceptual illustration of the comparison of QA creep strain test results to initial product acceptance creep strain test results (a) creep strain curves, and (b) envelope of time to the specified strain.

### E. Assessment of the Creep Stiffness at Low Strain

The comparison between the creep data obtained for the initial product acceptance testing and the QA creep data shall be performed at a specified strain, in this case typically 2%. Where the selected strain level intersects each creep curve, determine the time required to reach the specified strain. Plot the load level as a function of the logarithm of time to reach the specified strain for the initial product acceptance data, and perform a regression for this data set. The log times to the specified strain level for the QA creep data shall be determined at a load level that corresponds to 1,000 hours on the initial product acceptance creep curve. The estimated time to reach the same specified strain for each of the two QA creep data points shall be equal to or greater than the 95% lower prediction limit of the variable, log time, established by the Student's  $t$  test of the original product acceptance data set, using Equations 4 and 5 (see part "c" above).

Once  $\log t_L$  has been determined at the specified load level, compare this value to the log time to reach the specified strain (i.e.,  $\log t_{QA}$ ) obtained for each QA creep test at the specified load level (e.g., 1,000 hours). If  $\log t_{QA} < \log t_L$  for any of the QA creep rupture test results, perform two additional tests at the same load level  $P$  for the specified strain and compare those results to  $\log t_L$ . If for these two additional tests this criterion is not met, perform adequate additional creep testing to establish a new low strain creep stiffness value for the product in accordance with initial product acceptance requirements (Appendix C). This new low strain creep stiffness value will form the baseline for any future QA testing.

### F. Durability Testing

For UV resistance (all polymers), molecular weight and CEG (PET only), and oven aging (PP and HDPE), the QA test results shall meet the minimum requirements provided in Table 1. For the oven aging tests (polyolefins only), compare the tensile strength retained (i.e., strength after oven exposure divided by the strength of the control specimens) to the strength observed during initial product acceptance testing. The maximum difference between the values of the changes shall be no greater than what is defined as statistically insignificant based on a one-sided student- $t$  distribution at a level of significance of 0.05, as determined using Equation 3. In this case,  $P_1$  and  $P_2$  are defined as the strength retained after oven aging.

$t_{\alpha/2, n_1+n_2-2}$  calculated using Equation 3 shall be no greater than  $t$  determined from the applicable Student  $t$  table (or from the Microsoft EXCEL function  $TINV(\alpha, n-2)$ ) at  $\alpha/2 = 0.05$  and  $n_1+n_2-2$  degrees of freedom. If this is not true, and the difference between  $P_1$  and  $P_2$  is determined to be statistically significant, and  $P_1 > P_2$ , two additional samples from the same installation condition shall be tested and recalculated and statistically compared to  $P_1$ . If the QA test results are still unacceptable, or if the product loses more than 50% of its tensile strength during the QA test, a more complete investigation performed in accordance with Appendix D shall be performed.

If long-term performance durability testing was conducted to justify the use of a lower  $RF_D$  or to justify use in aggressive environments for initial product acceptance, the statistical methodology and criteria provided above for index oven aging (i.e., that there be no statistically significant difference between the initial product acceptance test results and the QA test results at a level of significance of 0.05) shall be applied to the oxidation or hydrolysis performance test results at the maximum exposure time and environmental conditions used for the OA testing.

## References

- AASHTO, 2002, *Standard Specifications for Highway Bridges*, American Association of State Highway and Transportation Officials, Seventeenth Edition, Washington, D.C., USA.
- AASHTO, 2004, *LRFD Bridge Design Specifications, with Interims*, American Association of State Highway and Transportation Officials, Third Edition, Washington, D.C., USA.
- Allen, T.M., 1991, "Determination of Long-Term Strength of Geosynthetics: a State-of-the-Art Review", *Proceedings of Geosynthetics '91*, Atlanta, GA, USA, Vol. 1, pp. 351-379.
- Elias, V., 2000, Corrosion/Degradation of Soil Reinforcements for Mechanically Stabilized Earth Walls and Reinforced Soil Slopes, FHWA-NHI-00-044, Federal Highway Administration, Washington, D.C.
- Elias, V., DiMaggio, J., and DiMillio, A., 1997, "FHWA Technical Note on the Degradation-Reduction Factors for Geosynthetics," *Geotechnical Fabrics Report*, Vol. 15, No. 6, pp. 24-26.
- Federal Highway Administration (FHWA), 1997, "Degradation Reduction Factors for Geosynthetics," *Federal Highway Administration Geotechnology Technical Note*.
- Geosynthetic Research Institute, 1998, "Carboxyl End Group Content of Polyethylene Terephthalate (PET) Yarns," GRI Test Method GG7.
- Geosynthetic Research Institute, 1998, "Determination of the Number Average Molecular Weight of Polyethylene Terephthalate (PET) Yarns based on a Relative Viscosity Value," GRI Test Method GG8.
- Koerner, G. R., Hsuan, Y. G., and Hart, M., 2001, *Field Monitoring and Laboratory Study of Geosynthetics in Reinforcement Applications*, GRI Report #26, Geosynthetic Research Institute, Drexel University, Philadelphia, PA, USA, 116 pp.
- Koerner, G. R., Hsuan, Y. G., and Koerner, R. M., 2002, "Field Measurements of Alkalinity (pH) Levels Behind Segmental Retaining Walls, or SRW's," *7<sup>th</sup> International Geosynthetics Conference*, Nice, France, Delmas, Gourc, and Girard, ed's, Vol. 4, pp. 1443-1446.
- Koerner, R. M. and Koerner, G. R., 1990, "A quantification and assessment of installation damage to geotextiles." *Proc. Fourth Intl. Conf. on Geotextiles, Geomembranes, and Related Products*, The Hague, pp. 597-602.
- Risseuw, P, and Schmidt, H. M., 1990, "Hydrolysis of HT Polyester Yarns at Moderate Temperatures," *Proceedings of the Fourth International Conference on Geotextiles, Geomembranes, and Related Products*, The Hague, pp. 691-696.
- Sprague, C. J., Allen, S., and Thornton, S., 1999, "Installation Damage Testing, Sensitivity Assessment and Derivation of RF<sub>ID</sub>," *Geosynthetics '99*, Boston, MA, USA, pp. 1123-1132.
- Van Zanten, V., ed., 1986, *Geotextiles and Geomembranes in Civil Engineering*, Wiley-Halsted.
- Wadsworth, H., 1998, *Handbook of Statistical Methods for Engineers and Scientists*, McGraw-Hill, 688 pp.

## WSDOT Test Method No. 925, Appendix A

### **Product Specific Testing and Data Interpretation Requirements to Determine $RF_{ID}$ for Geosynthetic Reinforcements**

The effect of installation damage on geosynthetic reinforcement strength and deformation shall be determined from the results of full scale installation damage tests in accordance with ASTM D5818, except as modified herein:

1. The locations of specimens within the sample to be removed for testing after installation and exhumation should be predetermined before installation through the use of a template. The specimens shall be large enough to be used for wide width testing (ASTM D4595 for geotextiles or ASTM D6637, specimen preparation method B or C for geogrids). A minimum of 20 specimen locations should be identified using a template for each installation condition evaluated. No specimen should be located closer than 150 mm (6 in.) from the edge of the sample. The locations of the specimens should be evenly distributed throughout the sample. Each specimen should be consecutively numbered before installation. The sample size shall be large enough to obtain the minimum number of specimens (i.e., 20) of the required dimensions.
2. Place and compact 150 mm (6 in.) or more of soil (same soil as used to cover the geosynthetic) on a flat, level, relatively incompressible subgrade. The compacted layer shall simulate the roughness and compressibility of the backfill conditions in which the geosynthetic layer is likely to be placed in full scale structures.
3. Place the geosynthetic on top of the compacted soil pad. The geosynthetic shall be pulled taught with no wrinkles or folds. It may be necessary to pin the corners of the geosynthetic to maintain its position as soil is placed over the geosynthetic.
4. Place and compact 150 to 200 mm (6 to 8 in.) of backfill material (or other previously agreed upon depth to simulate actual installation conditions likely to be encountered) over the geosynthetic using the type of spreading and compacting equipment that is likely to be used in full scale structures. The backfill should be compacted to a minimum of 90 percent of Modified Proctor per ASTM D1557, or to another compaction standard typically used for geosynthetic reinforced structures if agreed upon in advance by the approval authority.
5. The sample shall be removed from the compacted fill in a way that minimizes damage to the sample caused by the excavation process. The sample removal process is generally described in ASTM D5818. In addition to the removal methods described therein, a lifting plate may be placed below the compacted soil pad below the geosynthetic layer as described in Sprague and Allen (2003) to facilitate easy removal of the soil above the geosynthetic.
6. The first nine prenumbered specimens identified on the exhumed sample shall be selected for testing. If any of these specimens were damaged due to the exhumation process, that specimen(s) shall be skipped, and the next consecutively numbered specimen(s) shall be selected for testing. If the coefficient of variation for the tensile test results of these first nine prenumbered specimens is greater than 5%, the required number of specimens shall be recomputed using the one-sided student t distribution as required by ASTM D4595 or ASTM D6637. The additional specimens shall be



7. Samples subjected to installation damage shall be tested for tensile strength and deformation characteristics in accordance with ASTM D4595, or ASTM D6637. The number of specimens tested should be in accordance with ASTM D4595 or D6637. Single rib tests such as GRI:GG1 shall not be used for installation damage evaluation, as it is difficult to assess the effect of severed ribs on the strength and stiffness of damaged materials. Test results from damaged specimens shall be compared to tensile test results obtained from undamaged (i.e., not exposed to installation conditions) specimens taken from the same lot, and preferably the same roll, of material as the damaged specimens.

8. The installation damage reduction factor  $RF_{ID}$  is then determined as follows:

$$RF_{ID} = \frac{T_{lot}}{T_{dam}} \quad (A-1)$$

where,  $T_{lot}$  is the average lot specific tensile strength before exposure to installation, and  $T_{dam}$  is the average lot specific tensile strength after installation. In no case should  $RF_{ID}$  be less than 1.1.

9. To select an appropriate reduction factor for design, the project site installation conditions must be related to the installation test conditions. To relate the installation damage test conditions to the actual site conditions, primary consideration will be given to the backfill characteristics (d50 particle size, potential for oversize material, particle angularity, and overall gradation), and to a lesser degree the method of spreading the backfill over the geosynthetic, the type of compaction equipment, and initial backfill lift thickness over the geosynthetic, provided that the initial lift thickness is 150 mm (6 in.) or more. The actual installation conditions used in the test must be clearly stated in the test report, specifically identifying any deviations from typical geosynthetic reinforcement installation practices in full scale structures, and the impact those deviations may have on the values of  $RF_{ID}$  determined. Typical installation conditions, for the purposes of this protocol, are generally described as follows:

- The geosynthetic is placed on a subgrade prepared as described in step 2.
- Backfill material is placed and spread on the geosynthetic using full scale spreading and compaction equipment commonly used in wall or reinforced slope construction (e.g., loaded dump trucks, dozers such as a D-6 or larger, etc.).
- Backfill is compacted using a full scale vibratory drum roller (i.e., one that someone can drive, not a smaller walk behind unit typically used to compact near the face of a wall to prevent distortion of facing elements during compaction).

If it is not possible to conduct the installation damage test in a way that fully simulates these “typical” installation conditions (i.e., installation conditions in the test are less severe than the conditions described above, for example, use lighter equipment, less movement of soil over the geosynthetic as the backfill is spread, etc.), data must be provided that demonstrates the effect the use of these less severe installation conditions would have on  $RF_{ID}$ .

10. If the installation damage test is conducted for a specific project, the actual backfill material planned for use in the geosynthetic structure should be used for the test. If the purpose of the installation damage testing is to generate  $RF_{ID}$  values for general use for future projects (i.e., the testing is not intended to be project specific), a range of soil backfill gradations/types should be used in the testing. The range of backfill materials selected should permit interpolation as needed to match the specific soil to be used as reinforced soil backfill. In general, the backfill materials tested should range from soil classified as a sand to coarse gravel (e.g.,  $d_{50}$  sizes ranging from 0.5 to 25 mm). The backfill materials selected should be angular to subangular and shall be durable. The coarse sand and gravel portions of the backfill material should have a Los Angeles Wear (LA Wear) percent loss after 500 revolutions (AASHTO T96) of no more than 35 percent. Additional installation damage tests may be conducted with a less durable backfill material, at the discretion of the manufacturer and the approval authority. If tests are conducted using a backfill material that does not meet the LA Wear requirement stated above, the condition of the backfill shall be evaluated for changes in angularity and gradation after each use. If changes in these two parameters are observed, the aggregate shall be immediately replaced with fresh material. This gradation/angularity evaluation should be conducted periodically even for more durable backfill material. Note that if the backfill materials available in the region for which the approval authority has jurisdiction consistently cannot meet the maximum LA Wear requirement of 35 percent loss, a less durable aggregate may be used for all the backfill materials tested, at the discretion of the approval authority.
11. Values of  $RF_{ID}$  may be estimated for a specified soil gradation using interpolation as illustrated in Figure A-1. The  $d_{50}$  size of the soil has commonly been used for interpolating between soil backfills for determination of  $RF_{ID}$ . Other combinations of soil particle size and factors that account for soil angularity and durability may be considered for this correlation and interpolation procedure per mutual agreement between the geosynthetic manufacturer and the approval authority. The range of backfill gradations, angularity, and durability will affect the range of applicability of the  $RF_{ID}$  values obtained from the testing.  $RF_{ID}$  values should not be extrapolated beyond the coarsest backfill soil tested.

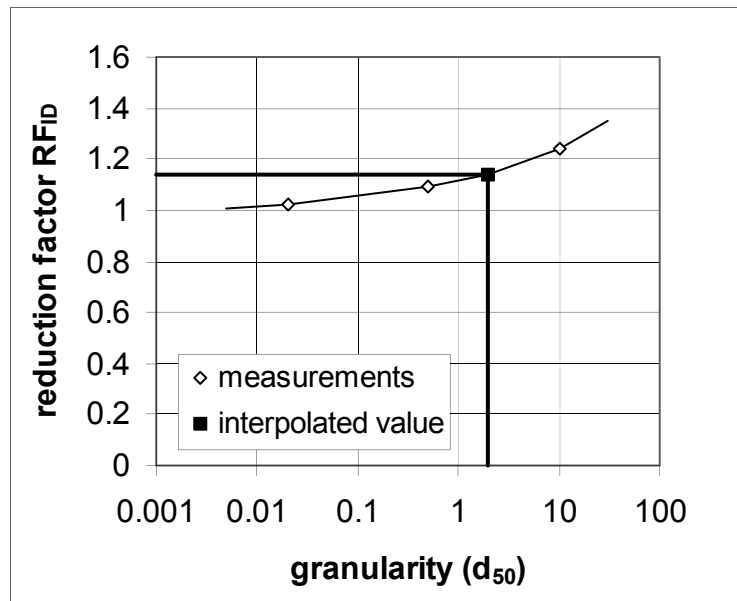
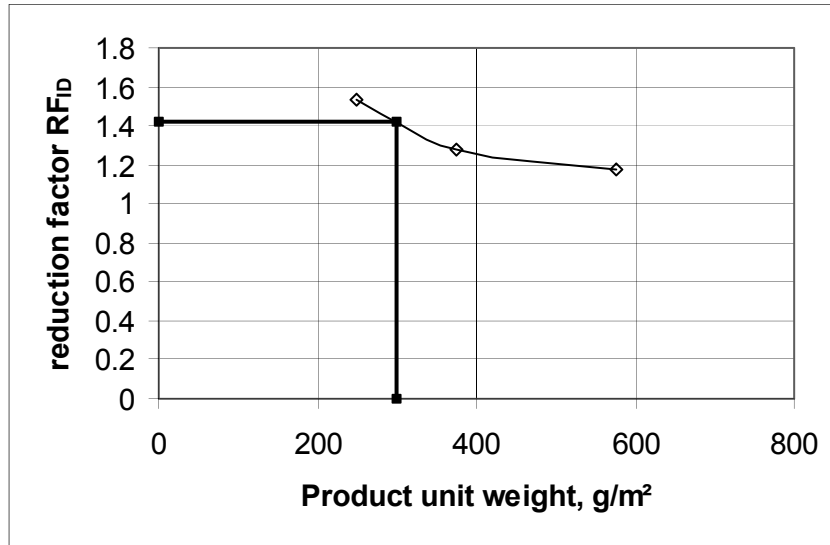

Figure A-1. Interpolation of  $RF_{ID}$  for a soil with  $d_{50} = 2$  mm from installation damage data obtained for soils with  $d_{50} = 0.02, 0.5$  and  $10$  mm (Note: 1 in. = 0.0254 mm).

12. Not all products within a product line need to be tested for installation damage. As a minimum, the weakest (lightest) and strongest (heaviest) products within the product line, plus at least one additional intermediate strength (weight) product should be used to characterize  $RF_{ID}$  for the product line (note: if the strongest product within the product line is not tested, all heavier products will be assumed to have the same value of  $RF_{ID}$  as the heaviest product tested). An example of this interpolation procedure is provided in Figure 2. For coated polyester geogrids, the coating thickness or coating mass per unit area relative to the mass per unit area of the product should be considered for the purpose of correlating  $RF_{ID}$  between products rather than product unit weight or tensile strength alone. It is acceptable to obtain the coating mass/unit area through the use of manufacturer Quality Control (QC) data on the lot specific mass/unit area of the uncoated material (i.e., the weight of the “greige-good”), subtracting that mass/unit area from the total mass/unit area of the finished product. Therefore, the total mass per unit area of the sample used in the installation damage testing should be obtained in accordance with ASTM D5261.



Figure, A-2. Example interpolation of  $RF_{ID}$  from damage measurements on products from the same line but with different weights. For a product of weight  $300 \text{ g/m}^2$ ,  $RF_{ID} = 1.42$  (Note:  $1 \text{ oz/yd}^2 = 0.0295 \text{ gm/m}^2$ ).

If it is determined that the  $RF_{ID}$  values obtained for a product line are not correlated with product weight per unit area, undamaged tensile strength, coating weight, or some other product parameter, and the variance of  $RF_{ID}$  between any two products in the product line is 0.1 or more, then each product in the product line shall be tested. If in this case (i.e., no correlation could be found), the variance of  $RF_{ID}$  between any two products in the product line is less than 0.1 and the upper bound value of  $RF_{ID}$  is selected for all products in the product line, all products in the product line do not need to be tested.

## References

Sprague, C. J., Allen, S. A., 2003, "Testing Installation Damage of Geosynthetic Reinforcement," Geotechnical Fabrics Report, Vol. 21, No. 6, pp. 24-27.

## WSDOT Test Method No. 925, Appendix B

### Creep Rupture Testing and Extrapolation Procedures

The effect of long-term load/stress on geosynthetic reinforcement strength and deformation characteristics shall be determined from the results of product specific, controlled, long-term laboratory creep tests conducted for a range of load levels and durations in accordance with ASTM D5262 adequate for extrapolation purposes to the desired design life, carried out to rupture of the geosynthetic when possible. Creep testing in accordance with ASTM D5262, but carried out to rupture where feasible, is described herein as the “conventional method.” A limited number of conventional creep tests may be supplemented and extended to longer creep rupture times using ASTM D6992 (Stepped Isothermal Method, or SIM) as described in this appendix. Specimens should be tested in the direction in which the load will be applied in use. Test results shall be extrapolated to the required structure design life. Based on the extrapolated test results, for ultimate limit state design, determine the highest load level, designated  $T_1$ , which precludes both ductile and brittle creep rupture within the required lifetime.  $T_1$  should be determined at the required design life and at the design site temperature.

In both cases, unless otherwise specified or mutually agreed upon by the geosynthetic supplier, the testing laboratory, and the owner, a baseline testing temperature of 68° F (20° C) shall be used for this testing. Higher test temperatures shall be considered as elevated temperatures to be used for the purpose of time extrapolation. ASTM D5262 requires that the testing temperature be maintained at +3.6° F (2° C). For some polymers, this degree of variance could significantly affect the accuracy of the shift factors and extrapolations determined in accordance with this appendix. For polymers that are relatively sensitive to temperature variations, this issue should be considered when extrapolating creep data using time-temperature superposition techniques, or minimized by using a tighter temperature tolerance.

Note that the procedures provided in this appendix are for in-air creep rupture testing. The procedures provided herein can likely also be applied to creep tests conducted confined in-soil. However, there is little information available, at present, on which to confirm that these procedures can be applied to in-soil creep data without modification. Therefore, procedures for use and interpretation of in-soil creep testing in compliance with this standard practice are not provided.

Single ribs for geogrids, or yarns or narrow width specimens for woven geotextiles, may be used for creep testing for the determination of  $RF_{CR}$  provided that it can be shown through a limited creep testing program conducted as described in Section B.5 later in this appendix that the rupture behavior and envelope for the single ribs, yarns, or narrow width specimens are the same as that for the full width product, with product width as defined in ASTM D5262. This comparison must demonstrate that there is no statistical difference between the full width product creep rupture regression line and the single rib, yarn, or narrow width specimen regression line at a time of 1,000 hours using a student-t distribution at a confidence level of 0.10 (see Equation B.3-1 later in this appendix).

**Note 1:** Creep results in time dependent deformation that may continue to occur as long as the reinforcement is loaded. At low to intermediate load levels, depending on the polymer type, the creep rate will continue to decrease with time and may eventually stabilize, at least within the ability to measure creep. At higher load levels, creep will continue until rupture occurs.

In general, two types of creep tests are conducted: stress or creep rupture, and creep strain. Creep strains do not have to be monitored in creep rupture testing (strain measurement in this type of test is recommended, however), though creep strain tests can be carried to rupture. Rupture data is necessary if the creep reduction factor for ultimate limit state conditions,  $RF_{CR}$ , is to be determined. Creep rupture test results, if properly accelerated and extrapolated, can also be used to investigate the effects of stress cracking and the potential for a ductile to brittle transition to occur. This transition to brittle behavior, if it occurs, can cause a geosynthetic to fail in creep at lower loads and strains than anticipated from evaluating only creep strain and rate data.

### **B.1 Overview of Extrapolation Approach to Determine the Ultimate Limit State Creep Limit, $T_1$**

Considering that typical design lives for permanent MSE structures are 75 years or more, extrapolation of creep data will be required. Current practice allows creep data to be extrapolated up to one log cycle of time beyond the available data without some form of accelerated creep testing, or possibly other corroborating evidence (Jewell and Greenwood, 1988; Koerner, 1990). Based on this, unless one is prepared to obtain 7 to 10 years of creep data, temperature accelerated creep data, or possibly other corroborating evidence, must be obtained.

It is well known that temperature accelerates many chemical and physical processes in a predictable manner. In the case of creep, this means that the creep strains under a given applied load at a relatively high temperature and relatively short times will be approximately the same as the creep strains observed under the same applied load at a relatively low temperature and relatively long times. Temperature affects time to rupture at a given load in a similar manner. This means that the time to a given creep strain or to rupture measured at an elevated temperature can be made equivalent to the time expected to reach a given creep strain or to rupture at in-situ temperature through the use of a time shift factor.

The ability to accelerate creep with temperature for polyolefins such as polypropylene (PP) or high density polyethylene (HDPE) has been relatively well defined (Takaku, 1981; Bush, 1990; Popelar, et. al., 1991). Also for polyolefins, there is some risk that a “knee” in the stress rupture envelope due to a ductile to brittle transition could occur at some time beyond the available data (Popelar, et. al., 1991). Therefore, temperature accelerated creep data is strongly recommended for polyolefins. However, in practice, a ductile to brittle transition for polyolefin geosynthetic reinforcement products has so far not been observed, likely due to the highly oriented nature of polymer resulting from the processing necessary to make fibers and ribs. In general, the degree of orientation of the polymer is an important factor regarding the potential for ductile to brittle transitions.

For polyester (PET) geosynthetics, available evidence indicates that temperature can also be used to accelerate PET creep, based on data provided by den Hoedt, et. al., 1994 and others. However, the creep rupture envelopes for PET geosynthetics tend to be flatter than polyolefin creep rupture envelopes, and accurate determination of time-shift factors can be difficult for PET geosynthetics because of this. This may require greater accuracy in the PET stress rupture data than would be required for polyolefin geosynthetics to perform accurate extrapolations using elevated temperature data. This should be considered if using elevated temperature data to extrapolate PET stress rupture data. Note that a “knee” in the stress rupture envelope of PET does not appear to be likely based on the available data and the molecular structure of polyester.

If elevated temperature is used to obtain accelerated creep data, it is recommended that minimum increments of 10° C be used to select temperatures for elevated temperature creep testing. The highest temperature tested, however, should be below any transitions for the polymer in question. If one uses test temperatures below 70 to 75° C for polypropylene (PP), high density polyethylene (HDPE), and PET geosynthetics, significant polymer transitions will be avoided. If higher temperatures must be used, the effect of any transitions on the creep behavior should be carefully evaluated. One should also keep in mind that at these high temperatures, significant chemical interactions with the surrounding environment are possible, necessitating that somewhat lower temperatures or appropriate environmental controls be used. These chemical interactions are likely to cause the creep test results to be conservative. Therefore, from the user’s point of view, potential for chemical interactions is not detrimental to the validity of the data for predicting creep limits. However, exposure to temperatures near the upper end of these ranges could affect the stress-strain behavior of the material due to loss of molecular orientation, or possibly other effects that are not the result of chemical degradation. Therefore, care needs to be exercised when interpreting results from tests performed at temperatures near the maximum test temperatures indicated above. In general, if the stiffness of the material after exposure to the environment is significantly different from that of the virgin material, the stress-strain properties, and possibly the strength, of the material may have been affected by the exposure temperature in addition to the chemical environment. If the stiffness has been affected, the cause of the stiffness change should be thoroughly investigated to determine whether or not the change in stiffness is partially or fully due to the effect of temperature, or alternatively not use the data obtained at and above the temperature where the stiffness was affected.

Unless otherwise specified or required by site specific temperature data, an effective design temperature of 20° C ( $T_{amb}$ ) should be assumed.

A number of extrapolation and creep modeling methods have been reported in the literature (Findley, et. al., 1976; Wilding and Ward, 1978; Wilding and Ward, 1981; Takaku, 1981; McGown, et. al., 1984; Andrawes, et. al., 1986; Murray and McGown, 1988; Bush, 1990; Popelar, et. al., 1991; Helwany and Wu, 1992). Many of the methods discussed in the literature are quite involved and mathematically complex.

Two creep extrapolation techniques are provided herein for creep rupture evaluation: the conventional method, which utilizes a simplified visual/graphical approach, temperature acceleration of creep, regression techniques, and statistical extrapolation, and the Stepped Isothermal Method (SIM). This does not mean that the more complex mathematical modeling techniques cannot be used to extrapolate creep of geosynthetics; they are simply not explained herein. These two techniques are described in more detail as follows:

## B.2 Step-By-Step Procedures for Extrapolating Creep Rupture Data – Conventional Method

**Step 1:** Plot the creep rupture data as log time to rupture versus log load level, as shown in Figure B.2-1. Do this for each temperature in which creep rupture data is available. For some materials, a semi-log rather than a log-log plot could be used. The plotting method that provides the best and most consistent fit of the data should be used. In general, approximately 12 to 18 data points (i.e., combined from all temperature levels tested to produce the envelope for a given product, with a minimum of 4 data points at each temperature) are required to establish a rupture envelope (Jewell and Greenwood, 1988; ASTM D2837). The data points should be evenly distributed through each log cycle of time. Rupture points with a time to rupture of less than 5 hours should in general not be used, unless it can be shown that these shorter duration points are consistent with the rest of the envelope (i.e., they do not contribute to non-linearity of the envelope). As a guide, three of the test results should have rupture times (not shifted by temperature acceleration) of 10 to 100 hours, four of the test results should have rupture times between 100 and 1,000 hours, and four of the test results should have rupture times of 1,000 to 10,000 hours, with at least one additional test result having a rupture time of approximately 10,000 hours (1.14 years) or more. It is recommended that creep strain be measured as well as time to rupture, since the creep strain data may assist with conventional time-temperature shifting and in identifying any change in behavior that could invalidate extrapolation of the results.

**Step 2:** Extrapolate the creep rupture data. Elevated temperature creep rupture data can be used to extrapolate the rupture envelope at the design temperature through the use of a time shift factor,  $a_T$ . If the rupture envelope is approximately linear as illustrated in Figure B.2-1(a), the single time shift factor  $a_T$  should be adequate to perform the time-temperature superposition.

*Note 2: This time-temperature superposition procedure assumes that the creep-rupture curves at all temperatures are linear on a semi-logarithmic or double logarithmic scale and parallel. It has been found empirically that the curves for PET are semi-logarithmic and approximately parallel, or double logarithmic and approximately parallel in the case of HDPE and PP. It should be pointed out that the theory of Zhurkov (1965), which assumes that the fracture process is activated thermally with the additional effect of applied stress, predicts that the creep-rupture characteristics should be straight when plotted on a double logarithmic diagram, and that their gradients should be stress-dependent.*



Use of a single time shift factor to shift all the creep rupture data at a given temperature, termed “block shifting,” assumes that the shift factor  $a_T$  is not highly stress level dependent and that the envelopes at all temperatures are parallel, allowing an average value of  $a_T$  to be used for all of the rupture points at a given temperature. While research reported in the literature indicates that  $a_T$  may be somewhat stress level dependent and that the curves at all temperatures are not completely parallel, this assumption tends to result in a more conservative assessment of the creep reduction factor  $RF_{CR}$  (Thornton and Baker, 2002).

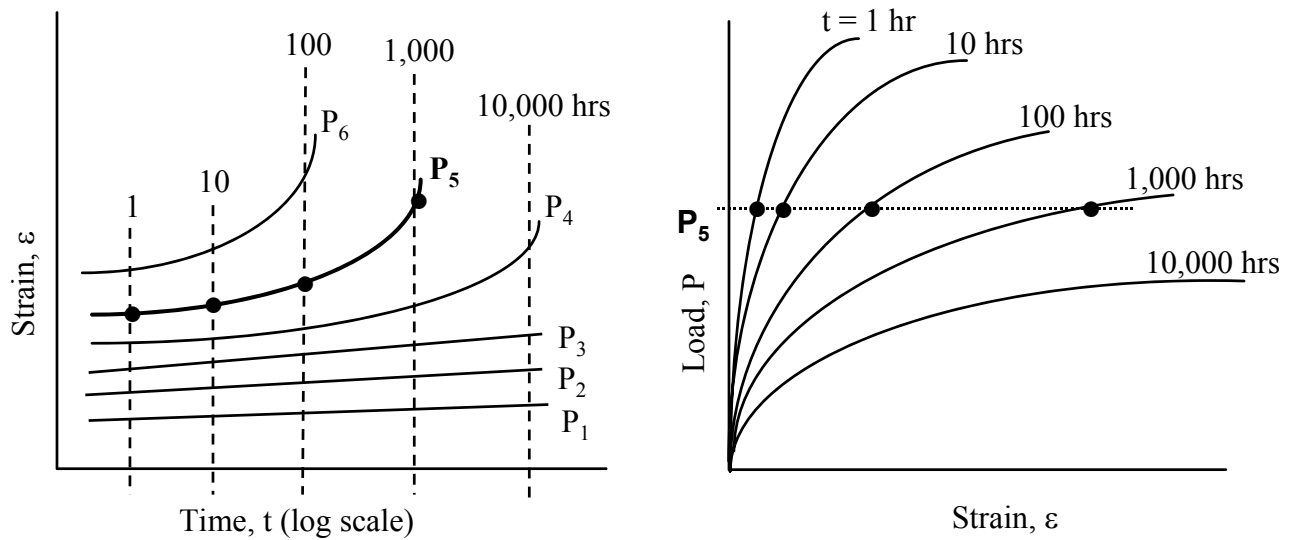

Figure B.2-1. Typical Stress Rupture Data for Geosynthetics, and the Determination of Shift Factors for Time-Temperature Superposition.

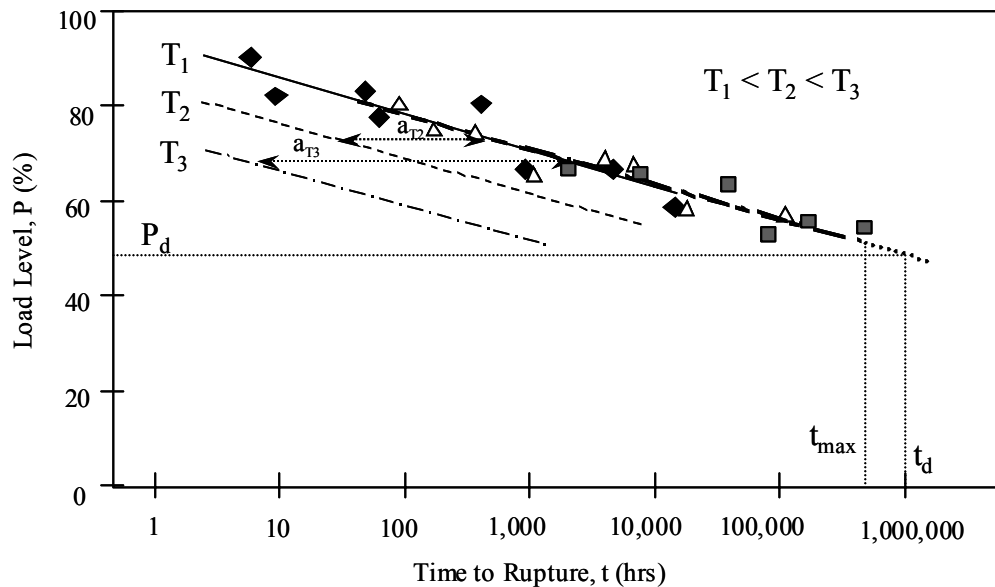

Figure B.2-2. Extrapolation of Stress Rupture Data and the Determination of the Creep Limit Load.

The time to rupture for the elevated temperature rupture data is shifted in accordance with the following equation:

$$t_{\text{amb}} = (t_{\text{elev}})(a_T) \quad (\text{B.2-1})$$

where,  $t_{\text{amb}}$  is the predicted time at the ambient or temperature to reach rupture under the specified load,  $t_{\text{elev}}$  is the measured time at elevated temperature to reach a rupture under the specified load, and  $a_T$  is the time shift factor.  $a_T$  can be approximately estimated using a visual/graphical approach as illustrated in figures B.2-1 and B.2-2. The preferred approach, however, is to use a computer spreadsheet optimization program to select the best shift factors for each constant temperature block of data to produce the highest  $R^2$  value for the combined creep rupture envelope to produce the result in Figure B.2-2.

**Note 3:** *Incomplete tests may be included, with the test duration replacing the time to rupture, but should be listed as such in the reported results, provided that the test duration, after time shifting, is 10,000 hours or more. The rule for incomplete tests is as follows. The regression should be performed with and without the incomplete tests included. If the incomplete test results in an increase in the creep limit, keep the incomplete tests in the regression, but if not, do not include them in the regression, in both cases for incomplete tests that are 10,000 hours in duration after time shifting or more. Record the duration of the longest test which has ended in rupture, or the duration of the longest incomplete test whose duration exceeds its predicted time to failure: this duration is denoted as  $t_{\text{max}}$ .*

It is preferred that creep rupture data be extrapolated statistically beyond the elevated temperature time shifted data using regression analysis (i.e., curve fitting) up to a maximum of one log cycle of time for all geosynthetic polymers (greater extrapolation using only statistical methods is feasible, but uncertainty in the result increases substantially and must be taken into account). Therefore, adequate elevated temperature data should be obtained to limit the amount of statistical extrapolation required.

**Note 4:** *There may be situations where extrapolation to create a creep rupture envelope at a lower temperature than was tested is necessary. Situations where this may occur include the need to elevate the ambient temperature to have greater control regarding the temperature variations during the creep testing (i.e., ambient laboratory temperature may vary too much), or for sites where the effective design temperature is significantly lower than the “standard” reference temperature used for creep testing (e.g., northern or high elevation climates). In such cases, it is feasible to use lower bound shift factors based on previous creep testing experience to allow the creep rupture envelope to be shifted to the lower temperature, as shift factors for the materials typically used for geosynthetic reinforcement are reasonably consistent. Based on previous creep testing experience and data reported in the literature (Chow and Van Laeken 1991; Thornton, et al. 1998; Thornton, et al. 1998a; Lothspeich and Thornton 2000; Takemura 1959; Bush, 1990; Popelar, et al. 1990; Wrigley, et al. 2000; Takaku 1980; Thornton and Baker 2000), shift factors for HDPE and PP geosynthetics are typically in the range of 0.05 to 0.18 decades (i.e., log cycles of time) per 1° C increase in temperature (i.e., a 10° C increase would result in a time shift factor of 12 to 15) and 0.05 to 0.12 decades per 1° C increase in temperature for PET geosynthetics. It is recommended that if shifting the creep rupture envelope to temperatures below the available data is necessary, that a shift factor of 0.05 decades per 1° C increase in temperature for PP, HDPE, and PET be used. This default shift factor should not be used to shift the creep rupture data more than 10° C.*

**Step 3:** Once the creep data has been extrapolated, determine the design, lot specific, creep limit load by taking the load level at the desired design life directly from the extrapolated stress rupture envelope as shown in Figure B.2-2. If statistical extrapolation beyond the time shifted stress rupture envelopes (PP or HDPE), or beyond the actual data if temperature accelerated creep data is not available, is necessary to reach the specified design life, the calculated creep load  $T_1$  should be reduced by an extrapolation uncertainty factor as follows:

$$T_1 = P_{cl}/(1.2)^{x-1} \quad (\text{B.2-3})$$

where  $P_{cl}$  is the creep limit load taken directly from the extrapolated stress rupture envelope, and “x” is the number of log cycles of time the rupture envelope must be extrapolated beyond the actual or time shifted data, and is equal to  $\log t_d - \log t_{max}$  as illustrated in Figure B.2-2. The factor  $(1.2)^{x-1}$  is the extrapolation uncertainty factor. If extrapolating beyond the actual or time shifted data less than one log cycle, set “x-1” equal to “0”. This extrapolation uncertainty factor only applies to statistical extrapolation beyond the actual or time shifted data using regression analysis and assumes that a “knee” in the rupture envelope beyond the actual or time shifted data does not occur.

**Note 5:** *A condition on the extrapolation is that there is no evidence or reason to believe that the rupture behavior will change over the desired design life. It should be checked that at long durations, and at elevated temperatures if used:*

- *There is no apparent change in the gradient of the creep-rupture curve*
- *There is no evidence of disproportionately lower strains to failure*
- *There is no significant change in the appearance of the fracture surface.*

*Any evidence of such changes, particularly in accelerated tests, should lead to the exclusion of any reading where either the gradient, strain at failure or appearance of the failure is different to those in the test with the longest failure duration. Particular attention is drawn to the behavior of unoriented thermoplastics under sustained load, where a transition in behavior is observed in long-term creep-rupture testing (i.e., the so called “ductile to brittle transition – Popelar, et al., 1991). The effect of this transition is that the gradient of the creep-rupture curve becomes steeper at the so-called “knee” such that long-term failures occur at much shorter lifetimes than would otherwise be predicted. The strain at failure is greatly reduced and the appearance of the fracture surface changes from ductile to semi-brittle. If this is observed, any extrapolation should assume that the “knee” will occur. For the method of extrapolation reference should be made to ISO/FDIS 9080:2001, ASTM D2837, and Popelar, et al. (1991).*

This extrapolation uncertainty factor also assumes that the data quality is good, data scatter is reasonable, and that approximately 12 to 18 data points which are well distributed (see Step 1 for a definition of well distributed) defines the stress rupture envelope for the product. If these assumptions are not true for the data in question, this uncertainty factor should be increased. The uncertainty factor may also need to be adjusted if a method other than the one presented in detail herein is used for extrapolation. This will depend on how well that method compares to the method provided in this appendix. This extrapolation uncertainty factor should be increased to as much as  $(1.4)^x$  if there is the potential for a “knee” in the stress rupture envelope to occur beyond the actual or time shifted data, or

if the data quality, scatter, or amount is inadequate. Furthermore, if the data quantity or distribution over the time scale is inadequate, it may be necessary to begin applying the extrapolation uncertainty factor before the end of the time shifted data.

*Note 6: Based on experience, the  $R^2$  value for the composite (i.e., time shifted) creep rupture envelope should be approximately 0.8 to 0.9 or higher to be confident that Equation B.2-3 will adequately address the extrapolation uncertainty. If the  $R^2$  value is less than approximately 0.6 to 0.7, extrapolation uncertainty is likely to be unacceptably high, and additional testing and investigation should be performed. In general, such low  $R^2$  values are typically the result of data that is too bunched up, unusually high specimen to specimen variability, or possibly poor testing technique.*

### **B.3 Procedures for Extrapolating Creep Rupture Data – Stepped Isothermal Method (SIM)**

An alternative creep strain/rupture analysis and extrapolation approach that has recently become available for geosynthetics is the Stepped Isothermal Method (SIM) proposed, illustrated, and investigated by Thornton, et. al. (1997), Thornton, et. al. (1998), Thornton, et. al. (1998), and Thornton and Baker (2002). SIM has been applied successfully to PET geogrids and PP geotextiles. SIM utilizes an approach similar to the Williams-Landell-Ferry, or WLF, approach to creep extrapolation (Ferry, 1980), where master creep curves for a given material are produced from a series of short-term tests (i.e., creep test durations on the order of a few hours) on the same specimen over a wide range of temperatures (i.e., while the load on the specimen is held constant, the temperature is increased in steps). The sections of creep curve at the individual temperatures are shifted in time and combined to form a continuous prediction of the creep strain at the starting temperature.

Though the general principles of this method have been in use for many years in the polymer industry (Ferry, 1980), it has been only recently that this approach has been used for geosynthetics. Though this approach was initially developed to extrapolate creep strain data, it has been adapted to produce stress rupture data by taking the specimen to rupture once the highest test temperature is reached. In effect, through time shifting of the creep strain data obtained prior to rupture, the rupture point obtained has an equivalent shifted time that is several orders of magnitude greater than the actual test time, which could be on the order of only a few days.

The method is conducted in accordance with ASTM D 6992. Key issues are the very short test time used for this method, potential use of temperatures that are well above transitions in the geosynthetic material, and its complexity. Key technical advantages of the method, however, include more accurate determination of time shift factors, since the same specimen is used at the same load level at all of the temperatures (the “conventional” method must deal with the effect of specimen to specimen variability when determining the shift factors), and that time shift factors between temperatures are determined at the same load level, eliminating the effect of load level in the determination of the shift factors (in the “conventional” method, the shift factors used are in fact an average value for a wide range of loads).

SIM can be considered for use in generating and extrapolating geosynthetic creep and creep rupture data provided this method is shown to produce results which are consistent with the “conventional” extrapolation techniques recommended in this appendix. To this end, creep-rupture testing shall be conducted using conventional tests (ASTM D5262) and SIM

tests (ASTM D6992). At least six SIM rupture tests and six conventional rupture tests and shall be conducted one of the products in the product line being evaluated. Of the six SIM rupture tests, four shall have rupture times (shifted as appropriate) between 100 and 2000 hours and two shall have rupture times greater than 2000 hours. All of the conventional creep rupture points shall be obtained at the reference temperature (i.e., not temperature shifted). Creep rupture plots shall be constructed, regression lines computed and the log times to rupture determined at a load level that corresponds to 1,000 hours and 50,000 hours on the conventional creep rupture envelope, for the two data sets. The log time to rupture for the SIM regression at this load level shall be within the upper and lower 90% confidence limits of the mean conventional regressed rupture time at the same load level using Student's *t* test.

The confidence limit for the regression performed for the conventional creep rupture data is given by (Wadsworth, 1998):

$$\log t_L = \log t_{reg} \pm \left[ t_{\alpha, n-2} \sqrt{\frac{1}{n} + \frac{(P - \bar{P})^2}{\sum (P_i - \bar{P})^2}} \right] \times \sigma \quad (\text{B.3-1})$$

and

$$\sigma = \sqrt{\frac{\sum [\log t_i - \overline{\log t}]^2 - \frac{[\sum [(P_i - \bar{P})(\log t_i - \overline{\log t})]]^2}{\sum (P_i - \bar{P})^2}}{n - 2}} \quad (\text{B.3-2})$$

where:

- $\log t_L$  = lower and upper bound confidence limit. The + or – term in Equation B.2-1 results in the lower and upper bound confidence limits, respectively.
- $t_{reg}$  = time corresponding to the load level from the conventional creep rupture envelope at which the comparison between the two envelopes will be made (e.g., at 1,000 and 50,000 hrs after time shifting)
- $t_{\alpha, n-2}$  = value of the *t* distribution determined from applicable Student *t* table (or from the Microsoft EXCEL function TINV( $\alpha, n-2$ )) at  $\alpha = 0.10$  and  $n-2$  degrees of freedom (this corresponds to the 90% two-sided prediction limit).
- $n$  = the number of rupture or allowable run-out points in the original test sample (i.e., the conventional creep rupture data)
- $P$  = load level obtained at  $t_{reg}$  from the regression line developed from the conventional creep rupture testing
- $\bar{P}$  = the mean rupture load level for the original test sample (i.e., all rupture or run-out points used in the regression to establish the conventional creep rupture envelope)
- $P_i$  = the rupture load level of the *i*'th point for the rupture points used in the regression for establishing the conventional creep rupture envelope
- $\log t$  = the mean of the log of rupture time for the original test sample (i.e., all rupture or run-out points used in the regression to establish the conventional creep rupture envelope)
- $t_i$  = the rupture time of the *i*'th point for the rupture points used in the regression for establishing the conventional creep rupture envelope

Once  $\log t_L$ , both upper and lower bound, has been determined at the specified load level, compare these values to the log rupture time (i.e.,  $\log t_{SIM}$ ) obtained for the SIM creep rupture envelope test at the specified load level (e.g., 1,000 and 50,000 hours). The value of  $\log t_{SIM}$  at the two specified load levels must be between the upper and lower bound confidence limits ( $\log t_L$ ). If this requirement is not met, perform two additional SIM tests at each load level  $P$  for the specified  $t_{reg}$  where this comparison was made and develop a new SIM creep rupture envelope using all of the SIM data. If for the revised SIM regression envelope resulting from these additional tests this criterion is still not met, perform adequate additional conventional creep rupture testing to establish the complete rupture envelope for the product in accordance with this appendix).

If the criterion provided above is met, the SIM testing shall be considered to be consistent with the conventional data, and SIM may be used in combination with the conventional data to meet the requirements of Section B.2 regarding the number of rupture points and their distribution in time and maximum duration. Therefore, the combined data can be used to create the creep rupture envelope as shown in Figure B.2-2. In that figure, the SIM data shall be considered to already be time shifted. Equation B.2-3 is then used to determine  $T_1$ .

#### B.4 Determination of $RF_{CR}$

The creep reduction factor,  $RF_{CR}$ , is determined by comparing the long-term creep strength,  $T_1$ , to the ultimate tensile strength (ASTM D4595 or ASTM D6637) of the sample tested for creep ( $T_{lot}$ ). The sample tested for ultimate tensile strength should be taken from the same lot, and preferably the same roll, of material that is used for the creep testing. For ultimate limit state design, the strength reduction factor to prevent long-term creep rupture is determined as follows:

$$T_{al} = \frac{P_{95}}{RF_{ID} \times RF_D} \quad (B.4-1)$$

where,  $T_{lot}$  is the average lot specific ultimate tensile strength (ASTM D4595 or ASTM D6637) for the lot of material used for the creep testing. Note that this creep reduction factor takes extrapolation uncertainty into account, but does not take into account variability in the strength of the material. Material strength variability is taken into account when  $RF_{CR}$ , along with  $RF_{ID}$  and  $RF_D$ , are applied to  $T_{ult}$  to determine the long-term allowable tensile strength, as  $T_{ult}$  is a minimum average roll value. The minimum average roll value is essentially the value that is two standard deviations below the average value.

#### B.5 Use of Creep Data from “Similar” Products and Evaluation of Product Lines

Long-term creep data obtained from tests performed on older product lines, or other products within the same product line, may be applied to new product lines, or a similar product within the same product line, if one or both of the following conditions are met:

- The chemical and physical characteristics of tested products and proposed products are shown to be similar. Research data, though not necessarily developed by the product manufacturer, should be provided which shows that the minor differences between the tested and the untested products will result in equal or greater creep resistance for the untested products.
- A limited testing program is conducted on the new or similar product in question and compared with the results of the previously conducted full testing program.

For polyolefins, similarity could be judged based on molecular weight and structure of the main polymer (i.e., is the polymer branched or crosslinked, is it a homopolymer or a blend, percent crystallinity, etc.), percentage of material reprocessed, tenacity of the fibers and processing history, and polymer additives used (i.e., type and quantity of antioxidants or other additives used). For polyesters and polyamides, similarity could be judged based on molecular weight or intrinsic viscosity of the main polymer, carboxyl end group content, percent crystallinity, or other molecular structure variables, tenacity of the fibers and processing history, percentage of material reprocessed or recycled, and polymer additives used (e.g., pigments, etc.). The untested products should also have a similar macrostructure (i.e., woven, nonwoven, extruded grid, needlepunched, yarn structure, etc.) and fiber dimensions (e.g., thickness) relative to the tested products. It should be noted that percent crystallinity is not a controlled property and there is presently no indication of what an acceptable value for percent crystallinity should be.

For creep evaluation of a similar product not part of the original product line, this limited testing program should include creep tests taken to at least 1,000 to 2,000 hours in length before time shifting if using the “conventional” creep testing approach, with adequate elevated temperature data to permit extrapolation to 50,000 hours or more. If it has been verified that SIM can be used, in accordance with Section B.3, durations after time shifting due to elevated temperature up to a minimum of 50,000 hours are required. A minimum of 4 data points per temperature level tested should be obtained to determine time shift factors and to establish the envelope for the similar product. These limited creep test results must show that the performance of the similar product is equal to or better than the performance of the product previously tested. This comparison must demonstrate that there is no statistical difference between the old product regression line and the regression line obtained for the similar product at a time of 2,000 hours (not temperature accelerated) and 50,000 hours (after time shifting) using a student-t distribution at a confidence level of 0.10 (see Equation B.3-1). If no statistical difference is observed, the results from the full testing program on the older or similar product could be used for the new/similar product. If this is not the case, then a full testing and evaluation program for the similar product should be conducted.

Similarly, for extension of the creep data obtained on one product in the product line (i.e., the primary product tested, which is typically a product in the middle of the range of products in the product line) to the entire product line as defined herein, a limited creep testing program must be conducted on at least two additional products in the product line. The combination of the three or more products must span the full range of the product line in terms of weight and/or strength. The limited test program described in the preceding paragraph should be applied to each additional product in the product line. The loads obtained for the data in each envelope should then be normalized by the lot specific ultimate tensile strength,  $T_{lot}$ . All three envelopes should plot on top of one another, once normalized in this manner, and the two additional product envelopes should be located within the confidence limits for the product with the more fully developed creep rupture envelope (i.e., the “primary” product) as described above for “similar” products. If this is the case, then the creep reduction factor for the product line shall be the lesser of the reduction factor obtained for the product with the fully developed rupture envelope and the envelope of all three products combined, and normalization using the ultimate tensile strength shall be considered acceptably accurate.

If this is not the case, then the creep rupture envelopes for the other two products, plus enough other products within the product line, to establish the trend in  $RF_{CR}$  as a function of product weight or ultimate tensile strength, so that the  $RF_{CR}$  for the other products within the product line can be accurately interpolated. Furthermore,  $T_{al}$  must be determined in accordance with Note 7.

**Note 7:** *Note that normalization using the ultimate lot specific tensile strength may not be completely accurate for some geosynthetic products regarding characterization of creep rupture behavior, and other normalization techniques may be needed (Wrigley, et al., 1999). In such cases, individual creep reduction factors for each product in the product line may need to be established through fully developed creep rupture envelopes for representative products obtained at the low, middle, and high strength end of the product series. Once the creep limited strength,  $P_{cl}$  and the creep reduction factors are established for each product, in this case, product variability must still be taken into account. In such cases,  $T_{al}$  must be the lesser of the determination from Equation 1 and the following determination:*

$$T_{al} = \frac{P_{95}}{RF_{ID} \times RF_D}$$

where,

$P_{95}$  = the tensile strength determined from the 95% lower bound prediction limit for the creep rupture envelope at the specified design life (see Equations 4 and 5 in “Quality Assurance (QA) Criteria for Comparison to Initial Product Acceptance Test Results”)



## References

- AASHTO, 2002, *Standard Specifications for Highway Bridges*, American Association of State Highway and Transportation Officials, Seventeenth Edition, Washington, D.C., USA, 686 p.
- Andrawes, K. Z., McGown, A., and Murray, R. T., 1986, "The Load-Strain-Time Behavior of Geotextiles and Geogrids," *Proceedings of the Third International Conference on Geotextiles*, Vienna, Austria, pp. 707-712.
- Bush, D.I., 1990, "Variation of Long-Term Design Strength of Geosynthetics in Temperatures up to 40°C", *Proceedings of the Fourth International Conference on Geotextiles, Geomembranes, and Related Products*, The Hague, Netherlands, pp. 673-676.
- Chow and Van Laeken 1991, "Viscoelastic Relaxation in oriented Semicrystalline Polymers," *Polymer*, Vol. 32, pp. 1798-1802.
- den Hoedt, G., Voskamp, W., van den Heuvel, C. J. M., 1994, "Creep and Time-to-Rupture of Polyester Geogrids at Elevated Temperatures," *Proceedings of the Fifth International Conference on Geotextiles, Geomembranes, and Related Products*, Singapore, pp. 1125-1130.
- Ferry, J. D., 1980, *Viscoelastic Properties of Polymers*, 3rd Edition, John Wiley and Sons, NY.
- Findley, W. N., Lai, J. S., Onaran, K., 1976, *Creep and Relaxation of Nonlinear Viscoelastic Materials*, Dover Publications, NY, 369 pp.
- Helwany, B., Wu, J. T. H., 1992, "A Generalized Creep Model for Geosynthetics," *International Symposium on Earth Reinforcement Practice*, Japan, pp.
- Jewell, R.A. and Greenwood, J.H., 1988, "Long-Term Strength and Safety in Steep Soil Slopes Reinforced by Polymer Materials", *Geotextiles and Geomembranes*, Vol. 7, Nos. 1 and 2, pp. 81-118.
- Koerner, R. M., 1990, "Determination of the Long-Term Design Strength of Stiff Geogrids," GRI Standard Practice GG4(a).
- Lothspeich, S., and Thornton, S., 2000, "Comparison of Long-term Design Reduction Factors Based on Creep Rupture and Creep Strength Criteria for Several Geosynthetic Reinforcing Materials," *EuroGeo 2*, pp. 341-346.
- McGown, A., Paine, N., and DuBois, D.D., 1984, "Use of Geogrid Properties in Limit Equilibrium Analysis", *Proceedings of the Symposium on Polymer Grid Reinforcement in Civil Engineering*, Paper No. 1.4, pp. 1-5.
- Murray, R. T., McGown, A., 1988, "Assessment of the Time Dependent Behavior of Geotextiles for Reinforced Soil Applications," *Durability of Geotextiles RILEM*, Chapman and Hall.
- Popelar, et al., 1990, "Viscoelastic Material Characterization and Modeling for Polyethylene," *Polymer Engineering and Science*, Vol. 30, no. 10, pp. 577-586.

- Popelar, C.H., Kenner, V.H., and Wooster, J.P., 1991, "An Accelerated Method for Establishing the Long Term Performance of Polyethylene Gas Pipe Materials", *Polymer Engineering and Science*, Vol. 31, pp. 1693-1700.
- Takaku, A., 1981, "Effect of Drawing on Creep Fracture of Polypropylene Fibers", *Journal of Applied Polymer Science*, Vol. 26, pp. 3565-3573.
- Takemura, 1959, Theoretical Consideration of the Effect of Crystallinity on the Viscoelastic Properties of Polyethylene," *Journal of Applied Polymer Science*, Vol. 38, pp. 471-478.
- Thornton, J. S., Allen, S. R., and Thomas, R. W., (1997) "Approaches for the Prediction of Long Term Viscoelastic Properties of Geosynthetics from ShortTerm Tests," *Geosynthetics '97*, IFAI, Long Beach, CA, Vol. 1, pp. 277-291.
- Thornton, J. S., Allen, S. R., Thomas, R. W., and Sandri, D., 1998, "The Stepped Isothermal Method for Time-Temperature Superposition and Its Application to Creep Data of Polyester Yarns," *Sixth International Conference on Geotextiles, Geomembranes, and Related Products*, Atlanta, GA, pp.699-706.
- Thornton, J. S., and Baker, T. L., 2002, "Comparison of SIM and conventional Methods for Determining Creep-Rupture Behavior of a Polypropylene Geotextile," *7<sup>th</sup> International Geosynthetics Conference*, Nice, France, Vol. 4, pp. 1545-1550.
- Thornton, J. S., Paulson, J., and Sandri, D., 1998a, "Conventional and Stepped Isothermal Methods for Characterizing Long-Term Creep Strength of Polyester Geogrids," *Sixth International Conference on Geotextiles, Geomembranes, and Related Products*, Atlanta, GA, pp.691-698.
- Wadsworth, H., 1998, *Handbook of Statistical Methods for Engineers and Scientists*, McGraw-Hill, 688 pp.
- Wilding, M.A. and Ward, I.M., 1978, "Tensile and Creep Recovery in Ultra-High Modulus Polyethylenes," *Polymer*, Vol. 19, pp.
- Wilding, M.A. and Ward, I.M., 1981, "Creep and Recovery of Ultra High Modulus Polyethylene", *Polymer*, Vol. 22, pp. 870-876.
- Wrigley, N. E., Austin, R. A., and Harrison, P. E., 1999, "The Long-Term Strength of Geogrid Reinforcement," *Geosynthetics '99*, Boston, MA, USA, Vol. 2, pp. 711-721.
- Zhurkov, S. N., 1965, "Kinetic Concept of the Strength of Solids," *International Journal of Fracture Mechanics*, Vol. 1, pp. 311-323.

## WSDOT Test Method No. 925, Appendix C

### Strain Based Creep Testing and Extrapolation

This appendix provides supplementary information to Appendix B regarding the use and extrapolation of creep strain data.

As is true for stress rupture testing, in-air long-term laboratory creep tests should be conducted for a range of load levels in accordance with ASTM D5262, adequate for extrapolation to the required design life as described in this appendix. Specimens should be tested in the direction in which the load will be applied in use. Full width specimens should be tested, unless it can be shown through a limited testing program that single rib, yarn, or narrow width specimens can be used without affecting the creep rupture envelope (see beginning of Appendix B), though in the case of creep strain testing and extrapolation, the rupture envelope is defined as the time to reach the instability limit strain (described later in Appendix C) Test results should be extrapolated to the required structure design life. Based on the extrapolated test results, for ultimate limit state design, determine the highest load level, designated  $T_1$ , at which the log time creep rate continues to decrease with time and which precludes both ductile and brittle creep rupture within the required lifetime.  $T_1$  should be determined at the required design life and at the effective design site temperature. Unless otherwise specified or required by site specific temperature data, an effective design temperature of 20° C ( $T_{amb}$ ) should be assumed.

As stated above, the application of the extrapolated creep data as described in this appendix is to estimate the highest load level within the specified design lifetime that precludes creep rupture. When using creep strain data, creep rupture is assumed to occur, or is at least eminent, when the strain exceeds the instability strain limit (see Section C.1) Creep strain data can be used for other purposes, such as to estimate long-term deformations or to estimate long-term stiffness values. The extrapolated creep strain data developed in accordance with this Appendix can be used for these purposes as well.

#### C.1 Creep Strain Assessment Tools and Concepts

Creep strain curves are typically plotted as a function of time or the logarithm of time. In general, there are up to three stages of creep observed in polymeric materials – these include primary, secondary or steady-state, and tertiary creep. Primary creep strains are characteristically linear when plotted against a logarithmic time scale and increase at a decreasing rate on an arithmetic time scale. Secondary creep strains are typically linear when plotted against an arithmetic time scale. Tertiary creep is the rupture phase of creep and is characterized by a rapidly increasing creep rate with time. Geosynthetic structure tends to dominate primary creep (at least for nonwoven geotextiles, but much less so for woven geotextiles and not at all for geogrids), and the polymer characteristics tend to dominate secondary and tertiary creep mechanisms (Allen 1991). Polyolefins (HDPE and PP) tend to exhibit all three stages of creep, depending on the load level, whereas PET tends to only exhibit primary and tertiary creep. Figure C.1-1 illustrates these concepts.

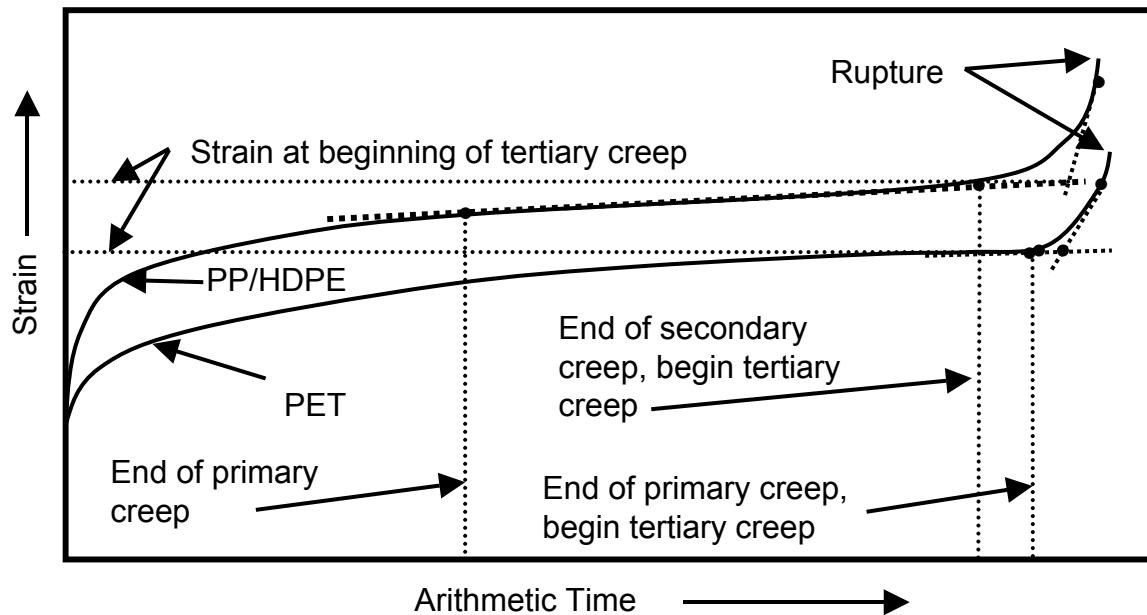
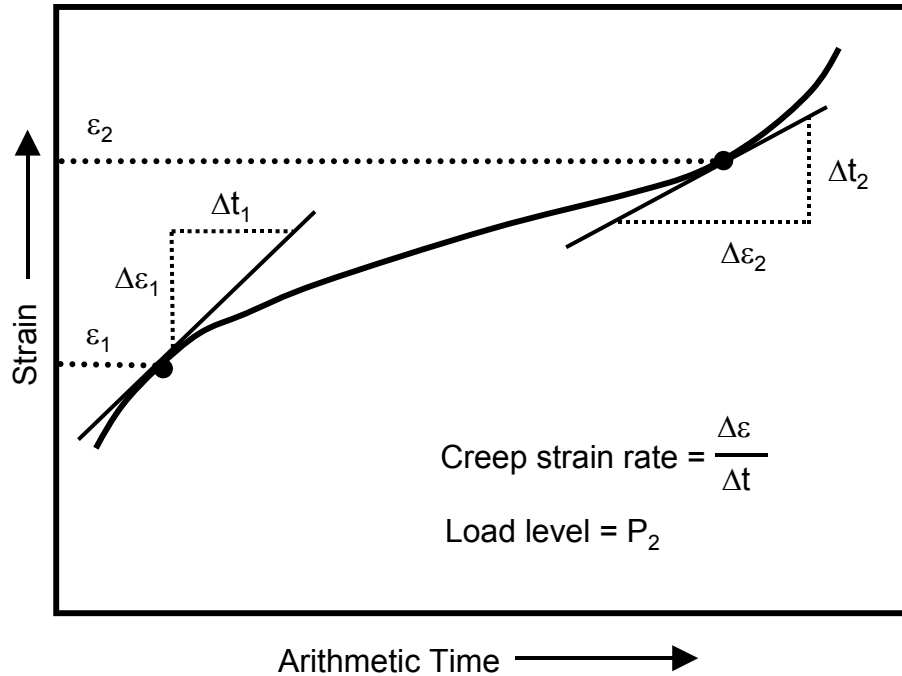

Figure C.1-1. Conceptual illustration of creep strain behavior, and the determination of the strain at the beginning of tertiary creep from creep strain data.

The instability limit strain is defined as the strain beyond which the material exhibits signs of instability, i.e., approaches failure (Andrawes, et. al., 1986). When extrapolating creep strain data, it is important to not extrapolate the data to strain levels that are in excess of the instability limit strain, as doing so would produce invalid results. The determination of this limit strain can be the most difficult part of assessing the creep rupture limit from creep strain data. The actual rupture strain, which occurs at the end of tertiary creep, for a given material at a given load level is difficult to measure as well as to identify. A more consistent and more easily measured instability limit strain would be the strain level where tertiary creep begins as illustrated in Figure C.1-1. However, if rupture occurs during the primary or secondary creep stage (e.g., PET) the instability limit strain is the rupture strain.

Another tool that can be useful in determining the strain at the beginning of tertiary creep is the Sherby-Dorn plot, as illustrated in Figure C.1-2. A Sherby-Dorn plot is a well known plotting technique used in polymer science (McGown et al. 1984a). Each curve represents a specific geosynthetic layer in a wall or a specific geosynthetic specimen tested at a specific load level. Creep strain rates observed under constant load are plotted against the total strain in the specimen or layer measured at the time the creep strain rate was calculated. The creep strain rate is simply the slope of the creep strain curve at a given point in time (see Figure C.1-2a). Curves that are linear or concave downward indicate that only primary creep is occurring, and that stabilization (no rupture) is likely. Curves that are concave upward indicate secondary or tertiary creep is occurring, and that rupture is likely. The closer the curves are located to the bottom left corner of the plot (Figure C.1-2), the better the creep performance of the material. The closer the curves are to the upper right corner, the more likely creep rupture will occur.



(a) Determination of creep strain rate.

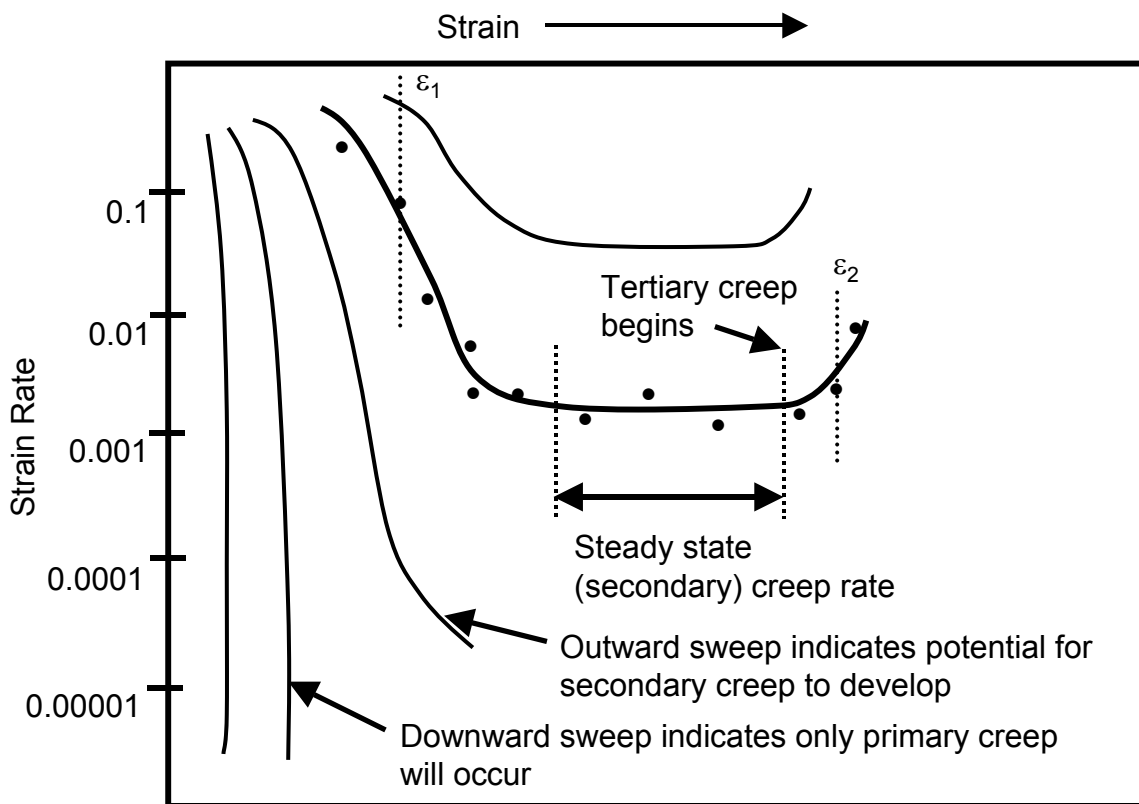

(b) Interpretation of Sherby-Dorn plots.

Figure C.1-2. Development and Use of Sherby-Dorn Plots to Analyze Creep Strain Data.

Note that some interpretation of the creep curves through curve fitting is required to determine strain rates, since local jumps in the measured creep strain curves can cause wide variations in calculated creep strain rates. The jumps in the curves are typically the result of the short increments of time used in the calculations and the small magnitude of changes in strain readings that may be at the limit of the resolution of the measuring devices. Hence, the slope of the measured creep curves must be taken over fairly long increments of time to be meaningful.

Tertiary creep begins where the creep strain rate (based on an arithmetic time scale) begins to increase. The strain at the beginning of tertiary creep is located where the creep strain rate begins to increase after reaching a minimum value, at least for polyolefin geosynthetics. A minimum and then an increasing creep strain rate is very difficult to see for polyester geosynthetics on this type of plot. Therefore, Sherby-Dorn plots tend to not be very useful for polyester geosynthetics.

To determine the long-term instability limit strain, the measured creep strain and time near creep rupture (i.e., at the beginning of tertiary creep) for various load levels must be obtained. These strains are plotted versus time to the beginning of tertiary creep (the rupture phase) on a semi-log plot (i.e., log time), or possibly a log-log plot, to establish the trend in the data. In general, strains near rupture for times to the rupture phase from 10 hours up to approximately 10,000 hours should be obtained so that the data need only be extrapolated two log cycles of time or less. A minimum of one data point per log cycle of time should be obtained to define the trend, but more data points are likely to be needed to establish the trend.

Typical near rupture strain trends for various geosynthetic polymers are illustrated in Figure C.1-3. Strain near rupture which increases as time to the rupture phase increases may be indicative of ductile behavior, whereas strain near rupture which decreases as time to the rupture phase increases may be indicative of brittle behavior (i.e., localized crack growth). If ductile behavior is observed, a transition to brittle behavior is possible. If such a shift to brittle behavior occurred, the strain near rupture increase occurring as time to the rupture phase increases (ductile behavior) could be lost as behavior becomes more brittle. Until more is known, it is recommended that strains near rupture which appear to be increasing as time to the rupture phase increases not be depended upon when assessing the long-term instability limit strain. Therefore, if the strain near rupture increases as time to the rupture phase increases, which appears to be typical of polypropylene (PP) geosynthetics (Takaku, 1981; Allen, 1991, Thornton and Baker, 2002), the short-term (i.e., rupture times on the order of 10 hours) strain near rupture should be used as the instability limit strain. If the strain near rupture decreases as time to the rupture phase increases, which appears to be typical of high density polyethylene (HDPE) geosynthetics (Ingold, et. al., 1994; Allen and Bathurst, 1996) and polyester (PET) geosynthetics (Krumm, 1988; Allen and Bathurst, 1996), extrapolate (up to a maximum of two log cycles) to the strain near rupture at the specified design life using visual extrapolation, regression analysis, or time-temperature superposition if elevated temperature data is available, and reduce that strain by a reduction factor of 1.1 to account for potential uncertainty. This reduction factor could be adjusted depending on the amount and quality of the strain near rupture data. The determination of the long-term instability strain limit is conceptually illustrated in Figure C.1-3.

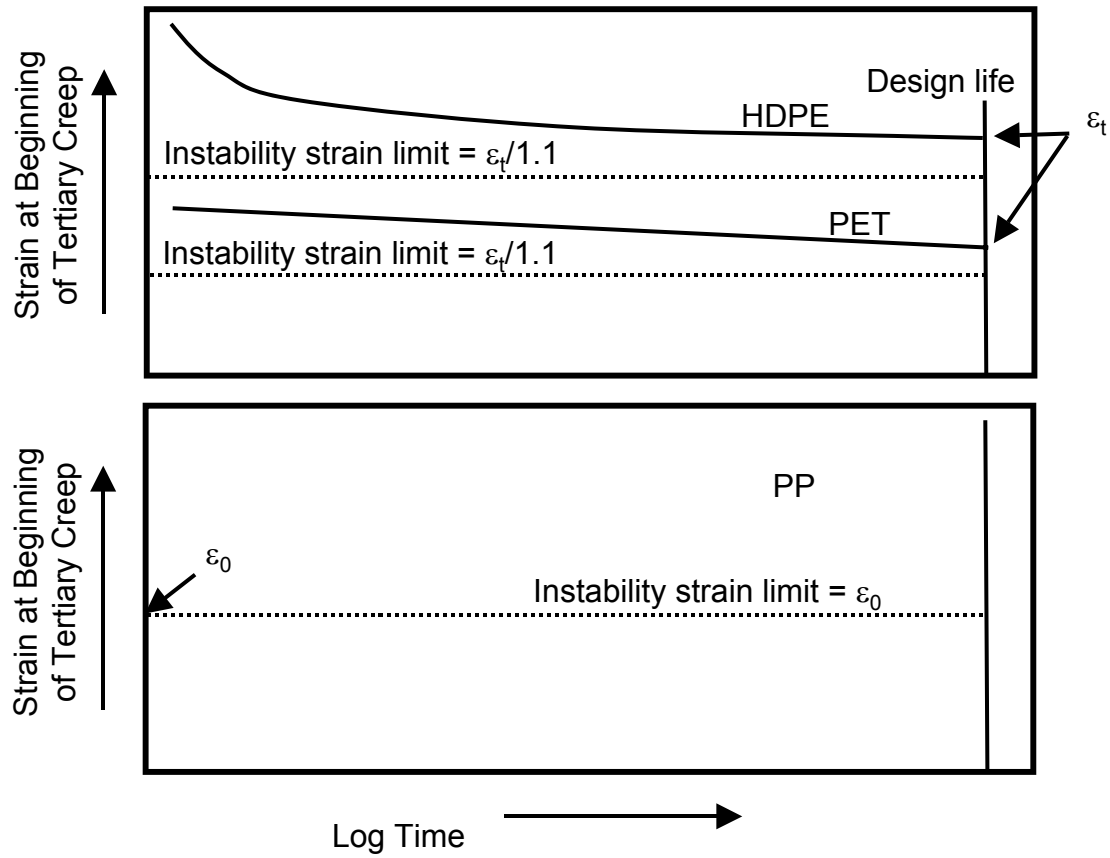

Figure C.1-3. Typical Near Rupture Behavior for Various Geosynthetic Polymers in Terms of Measured Strain.

If inadequate data is available to extrapolate measured strains near rupture to the long-term strain near rupture and the material type is likely to have strains near rupture which decrease with increasing time to the rupture phase (e.g., HDPE and PET), an acceptable alternative to estimate the instability limit strain is to take the peak strain measured from a wide width load-strain test (ASTM D4595 or ASTM D6637) and reduce it by a factor of 2.0.

Another tool that is useful for characterizing and working with creep strain data is the isochronous curve. Each isochronous (i.e., constant time) curve is created by taking load and strain levels from each creep curve at a given constant time and plotting them to form an isochronous curve. Some curve fitting may be necessary to account for specimen variability and to create a reasonably smooth curve. For HDPE, this curve fitting is reasonably straight-forward to do. However, for PET, the isochronous curves characteristically have an “s” shape at low strains resulting from load and strain dependent changes in the crystalline and between crystal arrangement of molecules within the polymer (Jewell and Greenwood, 1988; den Hoedt, et al, 1994). PP geosynthetics may also have inherent abrupt non-linearities in their isochronous curves at certain strain or load levels as observed by McGown, et al. (1984). Such changes in the curves resulting from physical processes in the polymer must be considered when constructing isochronous from creep strain data. Note that isochronous curves are not an extrapolation tool, but instead

are an interpolation tool. Isochronous curves provide a convenient method of interpolating between creep curves, which will be necessary to accomplish the creep extrapolation steps that follow.

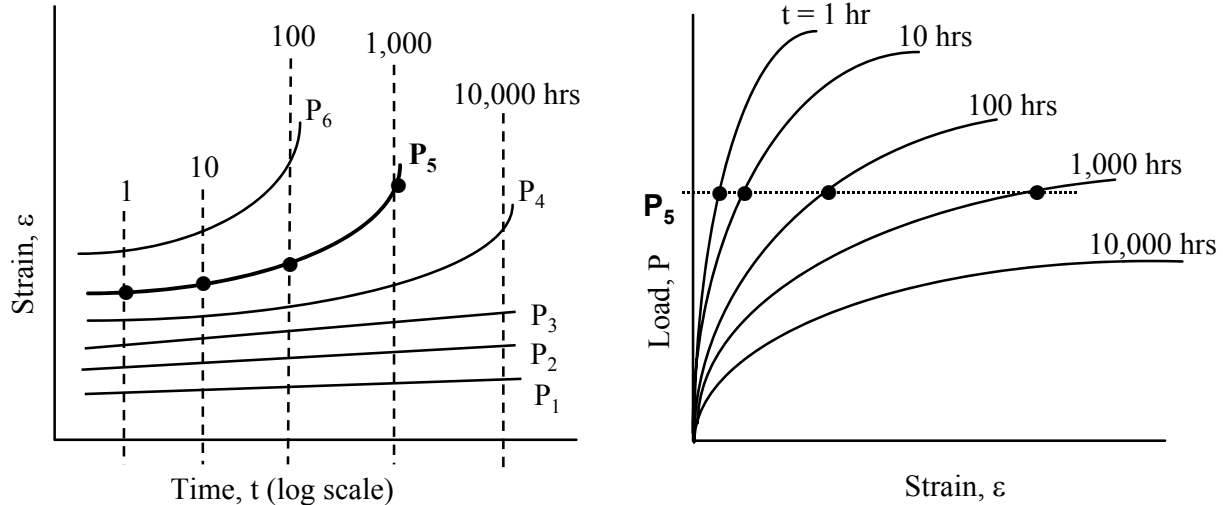

Figure C.1-4. Development of Isochronous Load-Strain Curves.

Creep stiffness curves as a function of time are also very useful to use for extrapolation purposes, or to simply estimate the long-term stiffness of the reinforcement for purposes of estimating deformation behavior. Select a constant strain or a constant load level from which to calculate the creep stiffness from the isochronous creep curves. At each point where the selected strain or load level intersects an isochronous curve, calculate the creep stiffness,  $J$ , as shown in Figure C.1-5, using the general form of the equation shown below:

$$J = P/\varepsilon \quad (C.1-1)$$

where, “ $P$ ” is the load, and “ $\varepsilon$ ” is the strain. Each isochronous curve represents the specific time associated with the calculated creep stiffness. The creep stiffness values calculated should be plotted as a function of log time as shown in Figure C.1-5. Note that creep stiffness values can be calculated directly from the creep curves (Figure C.1-1) by identifying where the specified strain intersects each creep curve, or for each creep curve estimate the strain at each selected time. As shown in Figure C.2.1-1, the load or strain level at which the creep stiffness values are calculated should be selected such that the strain near the end of the specified design life is approximately equal to or less than the instability limit strain, if it is desired to predict the maximum load level that will preclude rupture,  $T_1$ . Note that other strain or load levels could be selected to calculate the creep stiffness curves if it is desired to estimate deformations at working stress conditions or to estimate the long-term creep stiffness at working strains.



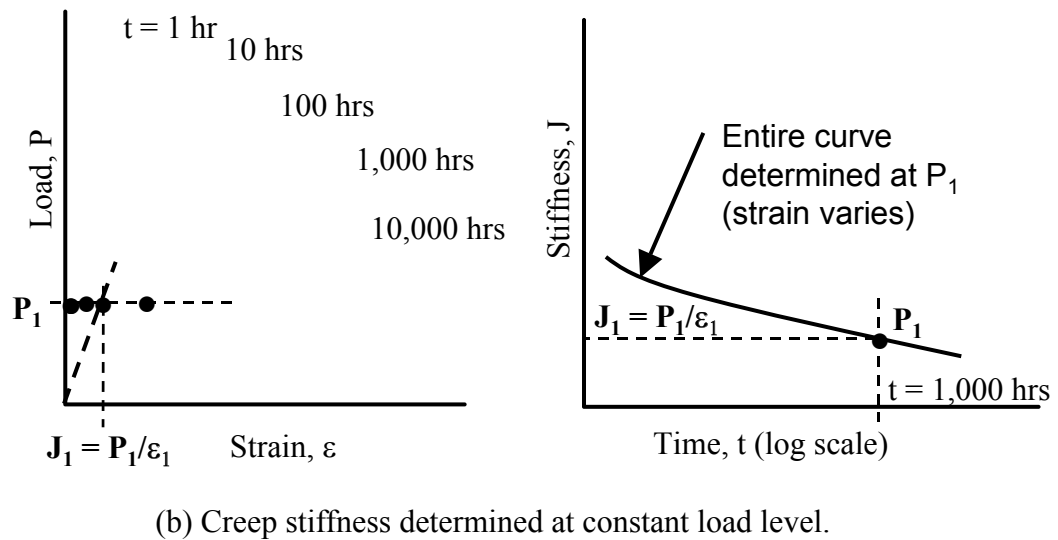
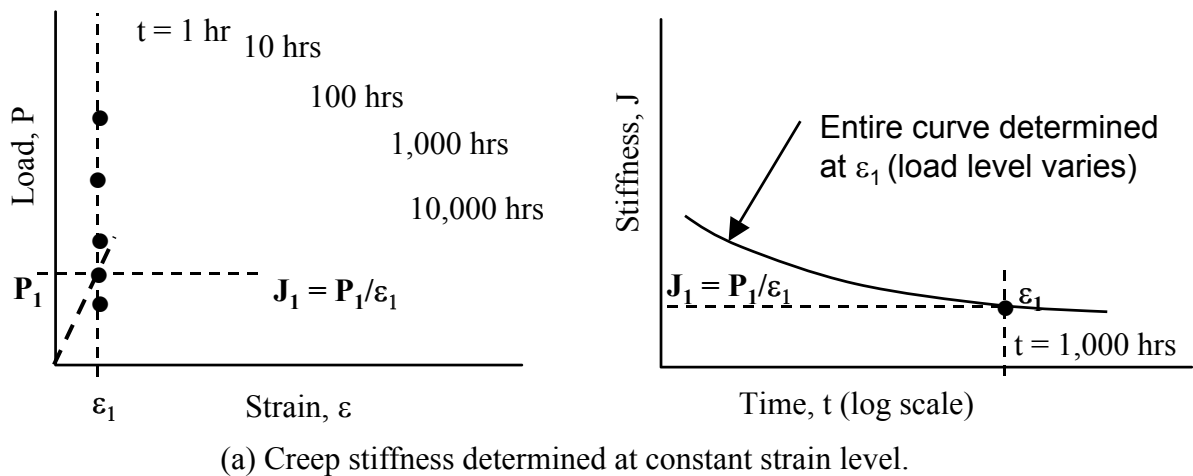

Figure C.1-5. Development of Creep Stiffness Curves.

## C.2 Creep Strain Data Extrapolation

The ability to accelerate creep with temperature for polyolefins such as polypropylene (PP) or high density polyethylene (HDPE) has been relatively well defined (Takaku, 1981; Bush, 1990; Popelar, et. al., 1991). Since the focus of the creep strain extrapolation method provided in this appendix is on the creep limit to prevent rupture during the design lifetime required, the issues affecting creep rupture data extrapolation also affect creep strain data extrapolation. Therefore, as is true for creep rupture testing, temperature accelerated creep data is strongly recommended for polyolefins. For polyester (PET) geosynthetics, evidence indicates that temperature can also be used to accelerate PET creep, based on data provided by den Hoedt, et. al., (1994), and others.

If elevated temperature is used to obtain accelerated creep data, it is recommended that minimum increments of 10° C be used to select temperatures for elevated temperature creep testing. The highest temperature tested, however, should be below any transitions for the polymer in question. If one uses test temperatures below 70 to 75° C for polypropylene

(PP), high density polyethylene (HDPE), and PET geosynthetics, significant polymer transitions will be avoided. One should also keep in mind that at these high temperatures, significant chemical interactions with the surrounding environment are possible, necessitating that somewhat lower temperatures or appropriate environmental controls be used. These chemical interactions are likely to cause the creep test results to be conservative. Therefore, from the user's point of view, potential for chemical interactions is not detrimental to the validity of the data for predicting creep limits. However, exposure to temperatures near the upper end of these ranges could affect the stress-strain behavior of the material due to loss of molecular orientation, or possibly other effects that are not the result of chemical degradation. Therefore, care needs to be exercised when interpreting results from tests performed at temperatures near the maximum test temperatures indicated above. In general, if the stiffness of the material after exposure to the environment is significantly different from that of the virgin material, the stress-strain properties, and possibly the strength, of the material may have been affected by the exposure temperature in addition to the chemical environment. If the stiffness has been affected, the cause of the stiffness change should be thoroughly investigated to determine whether or not the change in stiffness is partially or fully due to the effect of temperature, or alternatively not use the data obtained at and above the temperature where the stiffness was affected.

A number of extrapolation and creep modeling methods have been reported in the literature (Findley, et. al., 1976; Wilding and Ward, 1978; Wilding and Ward, 1981; Takaku, 1981; McGown, et. al., 1984a; Andrawes, et. al., 1986; Murray and McGown, 1988; Bush, 1990; Popelar, et. al., 1991; Helwany and Wu, 1992). Many of the methods discussed in the literature are quite involved and mathematically complex.

Two creep extrapolation techniques are provided herein for creep rupture evaluation: the conventional method, which utilizes a simplified visual/graphical approach, temperature acceleration of creep, regression techniques, and statistical extrapolation, and the Stepped Isothermal Method (SIM). This does not mean that the more complex mathematical modeling techniques cannot be used to extrapolate creep of geosynthetics; they are simply not explained herein.

The two techniques identified above are described in more detail in Appendix B, and as follows:

### **C.2.1 Step-By-Step Procedures for Extrapolating Creep Strain Data – Conventional Method**

**Step 1:** Plot the creep data. Plot the data as a semilog plot (log of time) or as an arithmetic plot (time). Do this separately for each temperature if data at elevated temperatures is available. For examples, see Figure C.1-1.

**Step 2:** Determine the instability limit strain (see Section C.1).

**Step 3:** Construct isochronous curves, as shown in Figure C.1-4.

**Step 4:** Develop creep stiffness curves for each temperature in which creep data is available, all at the same load level or strain level (see Figure C.1-5). Develop these stiffness curves at a strain level near the instability strain limit, or at a load level that results in a strain near the end of the specified design life that is approximately equal to the instability strain limit. These creep stiffness curves can then be used to perform time-

temperature superposition for the purpose of creep extrapolation. Note that more accurate time-temperature shift factors are likely to be obtained if the creep stiffness curves are produced at a constant load level (Figure C.1-5b) rather than constant strain level (Figure C.1-5a), as doing so avoids the additional uncertainty caused by the stress level dependence of the shift factors. In fact, using constant load level creep stiffness curves to determine shift factors should produce nearly identical results to the Stepped Isothermal Method (SIM), except that specimen to specimen variability will still be present (SIM eliminates the specimen to specimen variability when determining shift factors, since only one specimen is used – See Appendix B for more information on SIM).

**Step 5:** Extrapolate the creep data. For all geosynthetics, creep strain or stiffness data can be extrapolated statistically using regression analysis (i.e., curve fitting), or creep data can be accelerated by temperature to allow extrapolation using time-temperature superposition principles. It is well known that temperature accelerates many chemical and physical processes in a predictable manner. In the case of creep, this means that the creep strains under a given applied load at a relatively high temperature and relatively short times will be approximately the same as the creep strains observed under the same applied load at a relatively low temperature and relatively long times. This means that the time to a given creep strain or stiffness measured at an elevated temperature can be made equivalent to the time expected to reach a given creep strain or stiffness at in-situ temperature through the use of a time shift factor. Therefore, elevated temperature creep strain or stiffness data is made into equivalent in-situ temperature data as follows:

$$t_{\text{amb}} = (t_{\text{elev}})(a_T) \quad (\text{C.2.1-1})$$

where,  $t_{\text{amb}}$  is the predicted time at in-situ temperature to reach a specified creep stiffness or strain under the specified load,  $t_{\text{elev}}$  is the measured time at elevated temperature to reach a specified creep stiffness or strain under the specified load, and  $a_T$  is the time shift factor. For example, this means that if the time to reach a creep stiffness  $J_{c1}$  at elevated temperature is 10,000 hours, the creep stiffness will also be  $J_{c1}$  at in-situ temperature at a time of  $(10,000)(a_T)$  hours. In this way, the creep stiffness curve at in-situ temperature can be extrapolated to longer times.

The magnitude of the time shift factor can be determined graphically as illustrated in Figure C.2.1-1, or regression analysis of the composite creep stiffness curve can be used to optimize the shift factors to produce the highest  $R^2$  value for all of the time shifted data. Adjust  $a_T$  such that the creep stiffness curves at elevated temperature line up with the creep stiffness curve at the design (in-situ) temperature. Note that the magnitude of the shift factors for a given product can be different at different stages of creep (i.e., primary, secondary, or tertiary creep) and different load levels (see Appendix B). This should be considered when determining shift factors. See Note 4 in Appendix B, Section B.2 for additional considerations regarding the use of time shift factors.

**Step 6:** Once the creep data has been extrapolated, determine the design, lot specific, creep limit load as follows:

$$T_1 = (J_{c1})(\epsilon_i) \quad (\text{C.2.1-2})$$

where,  $J_{cl}$  is the creep stiffness at the desired design life and temperature, and  $\epsilon_i$  is the instability limit strain. If statistical extrapolation beyond the time shifted creep stiffness curves, or beyond the actual data if temperature accelerated creep data is not available, is necessary to reach the specified design life, the calculated creep load  $T_1$  should be reduced by an extrapolation uncertainty factor as follows:

$$T_1 = (J_{cl})(\epsilon_i)/(1.2)^{x-1} \quad (C.2.1-3)$$

where “x” is the number of log cycles of time the creep stiffness data must be extrapolated. Extrapolations greater than two log cycles of time are not recommended (see Appendix B for a more detailed explanation). The factor  $(1.2)^{x-1}$  is the extrapolation uncertainty factor. If extrapolating beyond the actual or time shifted data less than one log cycle, set “x-1” equal to “0”. This extrapolation uncertainty factor only applies to statistical extrapolation beyond the actual or time shifted data using regression analysis and assumes that a shift from ductile to brittle behavior beyond the actual or time shifted data does not occur. This extrapolation uncertainty factor also assumes that the data quality is good, data scatter is reasonable, and that a minimum of 5 load levels for each temperature are tested. The load levels should be well distributed within the load range tested, and at least one to two load levels should be high enough to produce rupture within the test time at each test temperature. If these assumptions are not true for the data in question, this uncertainty factor should be increased. The uncertainty factor may also need to be adjusted if a method other than the one presented in detail herein is used for extrapolation. This will depend on how well that method compares to the method provided in this appendix. This extrapolation uncertainty factor should be increased to as much as  $(1.4)^x$  if there is the potential for a shift from ductile to brittle behavior to occur beyond the actual or time shifted data, or if the data quality, scatter, or amount is inadequate (see Appendix B, Notes 5 and 6). Furthermore, if the data quality is inadequate, it may be necessary to begin applying the extrapolation uncertainty factor before the end of the time shifted data.

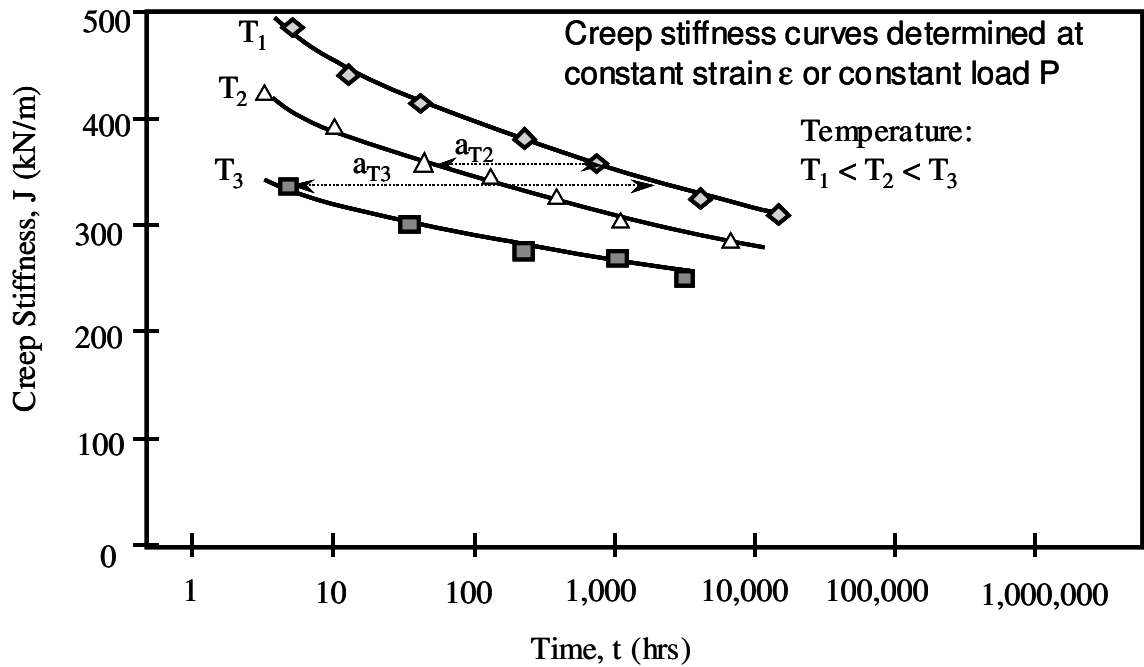

(a) Creep stiffness curves and determination of shift factors.

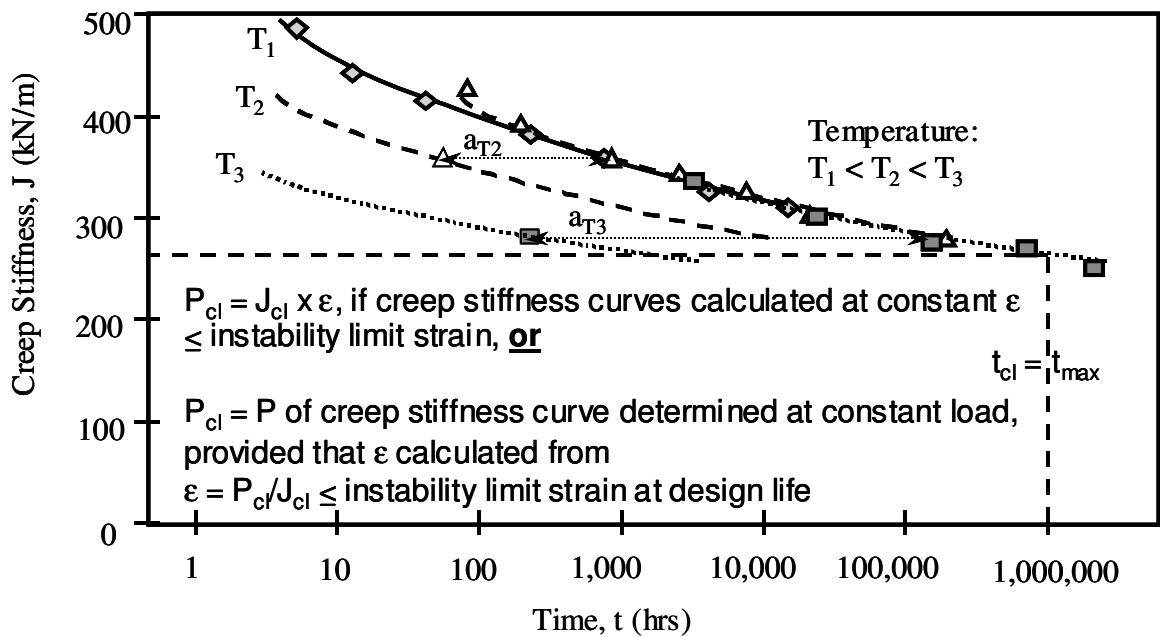

(b) Extrapolation of creep stiffness curves and determination of creep limit.

**Use of Time-Temperature Superposition to Extrapolate Creep Stiffness Curves.**  
**Figure C.2.1-1**

### C.2.2 Step-By-Step Procedures for Extrapolating Creep Strain Data – Stepped Isothermal Method (SIM)

See Appendix B for details regarding the description of SIM and issues regarding its use. SIM can be considered for use in generating and extrapolating geosynthetic creep data provided this method is shown to produce results which are consistent with the “conventional” extrapolation techniques recommended in this appendix. To this end, creep testing shall be conducted using conventional tests (ASTM D5262) and SIM tests (ASTM D6992). At least six SIM creep tests and six conventional creep tests shall be conducted on at least one of the products in the product line being evaluated. The load levels selected for the SIM tests and the conventional tests shall be the same. The range of load levels for both types of tests shall be evenly distributed between loads near the creep limit typical for the type of geosynthetic and polymer tested and load levels high enough to result in failure in approximately 100 hours or less (shifted time for SIM, unshifted time for conventional tests). All of the conventional creep tests shall be obtained at the reference temperature (i.e., not temperature shifted). The minimum duration of all of the tests shall be 1,000 hours or more (unshifted for conventional tests and time shifted for SIM).

The comparison between the SIM and conventional creep tests data shall be performed at a specified strain. The specified strain will depend on the strains observed in all of the creep tests (SIM and Conventional). Select a strain that will intercept all of the creep curves as much as possible. Preferably, the strain level should be approximately 5 to 10% or more. Where the selected strain level intersects each creep curve, determine the time required to reach the specified strain. Plot the load level as a function of the logarithm of time to reach the specified strain for each set of data, and perform a regression for each data set. Use the confidence limit test for comparing SIM to conventional data as described in Appendix B, using Equations B.3-1 and B.3-2. The log times to the specified strain level shall be determined at a load level that corresponds to 1,000 hours and 50,000 hours on the conventional creep envelope, for both data sets. The log time to rupture for the SIM regression at this load level shall be within the upper and lower 90% confidence limits of the mean conventional regressed time to the specified strain at the same load level using Student’s *t* test (see Appendix B for details regarding how to calculate this).

If this requirement is not met, perform two additional SIM tests at each load level *P* for the specified  $t_{reg}$  where this comparison was made and develop a new SIM time to the specified creep strain envelope using all of the SIM data. If for the revised SIM regression envelope resulting from these additional tests this criterion is still not met, perform adequate additional conventional creep rupture testing to adequately establish  $T_1$  for the product in accordance with this appendix.

If the criterion provided above is met, the SIM testing shall be considered to be consistent with the conventional data, and SIM may be used in combination with the conventional data to meet the requirements of this appendix regarding the number and duration of creep tests. In this case, the SIM data can be used to establish an isochronous curve at the specified design life (see Figure C.1-4). Once established, using a strain level equal to the instability strain limit for the product determined in accordance with Figure C.1-3 and

Section C.1, determine the load  $P_{cl}$  directly from the isochronous curve and calculate the creep limit load  $T_1$ .

### C.3 Determination of $RF_{CR}$

The creep reduction factor,  $RF_{CR}$ , is determined by comparing the long-term creep strength,  $T_1$ , to the ultimate tensile strength (ASTM D4595 or ASTM D6637) of the sample tested for creep. The sample tested for ultimate tensile strength should be taken from the same lot, and preferably the same roll, of material that is used for the creep testing. For ultimate limit state design, the strength reduction factor to prevent long-term creep rupture is determined as follows:

$$RF_{CR} = \frac{T_{lot}}{T_1} \quad (C.3-1)$$

where,  $T_{lot}$  is the average lot specific ultimate tensile strength (ASTM D4595 or ASTM D6637) for the lot of material used for the creep testing. Note that this creep reduction factor takes extrapolation uncertainty into account, but does not take into account variability in the strength of the material. Material strength variability is taken into account when  $RF_{CR}$ , along with  $RF_{ID}$  and  $RF_D$ , are applied to  $T_{lot}$  to determine the long-term allowable tensile strength, as  $T_{ult}$  is a minimum average roll value. The minimum average roll value is essentially the value that is two standard deviations below the average value.

### C.4 Estimation of Long-Term Creep Deformation

In-isolation creep strain data can be used to estimate post-construction strains and deformations (see Allen and Bathurst, 2002b). Since load levels in full scale structures as a percent of the ultimate tensile strength are generally quite low, adequate creep data must be obtained at low load levels (typically in the range of 2 to 20% of ultimate). The key to accurate estimation of creep strains in full scale structures is an accurate prediction of the load level.

**Step 1:** Estimate the load levels in the reinforcement layer(s). Current design specifications (AASHTO 2004, 2002) use the Simplified Method to estimate reinforcement loads in walls, or slope stability analysis techniques (Elias, et al., 2001) to assess reinforcement loads in reinforced slopes. Loads should be estimated for this purpose without any factor of safety or load factor applied. Based on the results obtained by Allen and Bathurst (2002a), the methods provided in current design specifications and guidelines tend to significantly over-predict reinforcement load levels in geosynthetic structures. A new method (the K-Stiffness Method) has been developed by Allen et al. (2003) that appears to predict reinforcement loads in geosynthetic structures much more accurately.

**Step 2:** From the available creep strain data, create isochronous curves (see Section C.1 and Figure C.1-4).

**Step 3:** Use the isochronous curves to create a creep strain curve at the desired load level, by selecting the strains at each time at the selected constant load level.

**Step 4:** Select the portion of the creep strain curve that is applicable to the post-construction strains in the full scale structure, accounting for the time required to build the structure (see Figure C.4-1).

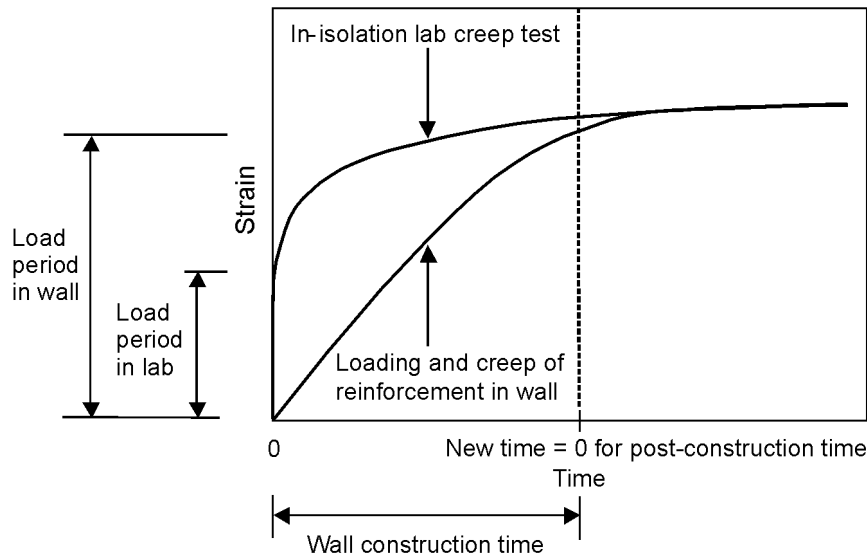

Figure C.4-1. Conceptual illustration showing adjustment of reinforcement creep strains measured in walls to in-isolation laboratory creep data (after Allen and Bathurst, 2002b).

**Step 5:** The creep strain is calculated as the strain at the desired design life plus the time required for the construction of the geosynthetic structure minus the strain at the end of the geosynthetic structure construction.

### C.5 Estimation of Creep Stiffness for Working Stress Design

Strains for working stress design, such as when using the K-Stiffness Method (Allen et al., 2003) are typically small (i.e., approximately 2%). Since reinforcement stiffness is generally a nonlinear function of strain, it is important to obtain the creep stiffness at the appropriate strain level. The primary purpose of this stiffness calculation is to provide input data for working stress methods such as the K-Stiffness method (Allen, et al., 2003), or for more sophisticated analyses such as finite element or finite difference numerical simulations. Typically, the stiffness at the end of structure construction ( $J_{EOC}$ ) or at the end of the structure design life ( $J_{DL}$ ) would be required as input for this type of analysis. Either “conventional” creep testing may be used, or SIM may be used if SIM is determined to be consistent with the conventional data as described in Section C.2.2.

The load application rate during creep load ramp up should be consistent with the application rate used in the governing tensile test method (e.g., ASTM D4595 or D6637). If it is not possible to accurately apply the load at a specified rate (e.g., if dead weight is applied through the use of a jack), the actual application rate should be measured and recorded.

If it has been shown that single rib/narrow width specimens can be used in lieu of full width specimens for creep testing at high load levels (see beginning of this appendix), single rib/narrow width specimens may also be used for low strain creep stiffness testing if respective short-term tensile tests also indicate no significant specimen width effects. The maximum difference between the mean values of the load at 2 percent strain in the single rib/narrow width tensile tests and the full width tensile tests must be no greater than what is considered statistically insignificant based on a one sided student-t distribution at a level of



The slack tension,  $T_0$ , applied to the specimen based on the governing tensile test (e.g., ASTM D4595 or D6337) will likely be too large for creep stiffness testing due to the very low loads that are likely for this type of testing. A maximum slack tension of approximately 10 percent of the anticipated load at 2 percent strain or 9 N (2 lbf), whichever is less, is recommended for single rib or narrow width specimens. For full width specimens (i.e., per ASTM D5262), a maximum slack tension of approximately 10 percent of the anticipated load at 2 percent strain or 70 N (15 lbf), whichever is less, is recommended. Since these maximum slack tension values differ from what is specified in ASTM D4595 and ASTM D6637, a special set of tensile tests may need to be conducted for use with the low strain creep stiffness testing program. ASTM D4595 and ASTM D6637 allow both the slack tension and the slack displacement,  $d_0$ , to be set to zero for calculation purposes. For low strain creep stiffness testing, the slack displacement should be set to zero, but the slack tension should be left at its full value for stiffness calculation purposes.

**Step 1:** Obtain creep strain data for at least one load level low enough to produce a strain level at the end of structure construction (assume to be 1,000 hrs unless otherwise specified by the approval authority). Per agreement between the approval authority and the reinforcement manufacturer, load levels to produce additional 1,000 hour strain levels may be tested. A minimum of two specimens per product at each load level shall be tested.

To establish the load levels needed to produce the desired 1,000 hour strains for each product, conduct a series of 1,000 second ramp and hold (R+H) tests. An initial estimate of the load levels needed for the R+H tests can be obtained from the tensile tests used to establish  $T_{lot}$  for each product tested. Test a load level that is likely to produce a strain of approximately 2 percent at 1,000 hours, and then two other load levels to bracket the 2 percent load level (e.g., at load levels that would yield approximately 1 percent strain and 3 to 4 percent strain at 1,000 hours). Do three replicate R+H tests at each of those load levels, plotting the load level as a function of the estimated strain at 1,000 hours, assuming a log linear extrapolation is valid for the R+H test results. Perform a regression analysis of that data to obtain a more accurate estimation of the load level required to produce a strain of 2 percent at 1,000 hours, and run three replicate R+H tests at that load level. If one of the load levels used for the R + H tests does not produce an estimated strain of 2 percent at 1,000 hours, a fourth set of three replicate R+H tests may be needed, estimating the load level based on a regression of the R+H tests for the first three load levels. Then conduct two full 1,000 hour creep tests at the R+H load level that results in the closest estimate to 2 percent strain at 1,000 hours.

**Note 1:** It is desirable to conduct the full 1,000 hour creep tests at the R+H load levels tested so that a direct comparison can be made between the 1,000 hour creep tests and the R+H tests. If the creep observed in the 1,000 hour creep tests is in fact log linear, the R+H tests can then be used for quality assurance testing in the future.

**Step 2:** Use the 1,000 hour creep test results, and any other available creep strain data for the same lot of material, to create isochronous creep curves as shown in Figure C.1-4, if the 1,000 hour creep stiffness tests do not achieve a strain of 2 percent (or other specified strain) at 1,000 hours..

**Step 3:** Create creep stiffness curves at the desired constant strain level (typically 2%) as shown in Figure C.1.5, and extrapolate to the desired time as necessary using the “conventional” approach illustrated in Figure C.2.1-1 or using SIM, if SIM has been determined to be applicable. In general, extrapolation should not be necessary if the “conventional” approach is used. Be sure to extrapolate the creep stiffness curve to the desired effective design temperature. The “conventional” approach (ASTM D 5262) shall be used unless comparative testing is conducted that demonstrated SIM (ASTM D6992) is providing results that are consistent with the “conventional” approach as defined in T 925.

**Step 4:** Obtain the creep stiffness,  $J_{EOC}$  or  $J_{DL}$ , at the desired time from the creep stiffness curve as shown in Figure C.2.1-1.

### C.6 Evaluation of Product Lines

Appendix B Section B.5 shall be used as the basis to apply creep strain data to product lines for determination of  $RF_{CR}$ . For creep stiffness assessment, a minimum of three products in the product line spanning the range of products in the line shall be tested as described in Section C.5. To interpolate to other products between the products tested, determine  $T_{lot}$  for each product tested, plotting the creep stiffness values obtained in Section C.5 as a function of  $T_{lot}$ . Creep stiffness values for other products in the product line not tested can be interpolated based on their tensile strength.

## References

- Allen, T.M., 1991, "Determination of Long-Term Strength of Geosynthetics: a State-of-the-Art Review", *Proceedings of Geosynthetics '91*, Atlanta, GA, USA, Vol. 1, pp. 351-379.
- Allen, T. M., and Bathurst, R. J., 1996, "Combined Allowable Strength Reduction Factor for Geosynthetic Creep and Installation Damage", *Geosynthetics International*, Vol. 3, No. 3, pp. 407-439.
- Allen, T.M., and Bathurst, R.J., 2002a, "Soil Reinforcement Loads in Geosynthetic Reinforced Walls at Working Stress Conditions", *Geosynthetics International*, *Geosynthetics International*, Vol. 9, Nos. 5-6, pp. 525-566.
- Allen, T.M., and Bathurst, R.J., 2002b, "Observed Long-Term Performance of Geosynthetic Walls, and Implications for Design", in press with *Geosynthetics International*, *Geosynthetics International*, Vol. 9, Nos. 5-6, pp. 567-606.
- Allen, T.M., Bathurst, R.J., Lee, W. F., Holtz, R. D., and Walters, D.L., 2003, "A New Working Stress Method for Prediction of Reinforcement Loads in Geosynthetic Walls", *Canadian Geotechnical Journal*, Vol. 40, No. 5, pp. 976-994.
- Andrawes, K. Z., McGown, A., and Murray, R. T., 1986, "The Load-Strain-Time Behavior of Geotextiles and Geogrids," *Proceedings of the Third International. Conference on Geotextiles*, Vienna, Austria, pp. 707-712.
- Bush, D.I., 1990, "Variation of Long-Term Design Strength of Geosynthetics in Temperatures up to 40°C", *Proceedings of the Fourth International. Conference on Geotextiles, Geomembranes, and Related Products*, The Hague, Netherlands, pp. 673-676.
- den Hoedt, G., Voskamp, W., van den Heuvel, C. J. M., 1994, "Creep and Time-to-Rupture of Polyester Geogrids at Elevated Temperatures," *Proceedings of the Fifth International. Conference on Geotextiles, Geomembranes, and Related Products*, Singapore, pp. 1125-1130.
- Ferry, J. D., 1980, *Viscoelastic Properties of Polymers*, 3rd Edition, John Wiley and Sons, NY.
- Ingold, T.S., Montanelli, F., and Rimoldi, P., 1994, "Extrapolation Techniques for Long Term Strengths of polymer Geogrids," *Proceedings of the Fifth International. Conference on Geotextiles, Geomembranes, and Related Products*, Singapore, pp. 1117-1120.
- Jewell, R.A. and Greenwood, J.H., 1988, "Long-Term Strength and Safety in Steep Soil Slopes Reinforced by Polymer Materials", *Geotextiles and Geomembranes*, Vol. 7, Nos. 1 and 2, pp. 81-118.
- Koerner, R. M., 1990, "Determination of the Long-Term Design Strength of Stiff Geogrids," GRI Standard Practice GG4(a).
- Krumm, G., 1988, *Der einfluss mechanischer schadigung auf das kriechverhalten von technischem filament - garn aus polyethylenterphthalat*, Diplomarbeit TU - Aachen.
- McGown, A., Andrawes, K. Z., Yeo, K. C. and DuBois, D.D., 1984, "The Load-Strain-Time Behavior of Tensar Geogrids", *Proceedings of the Symposium on Polymer Grid Reinforcement in Civil Engineering*, Paper No. 1.2, pp. 1-7.

- McGown, A., Paine, N., and DuBois, D.D., 1984a, "Use of Geogrid Properties in Limit Equilibrium Analysis", *Proceedings of the Symposium on Polymer Grid Reinforcement in Civil Engineering*, Paper No. 1.4, pp. 1-5.
- Popelar, C.H., Kenner, V.H., and Wooster, J.P., 1991, "An Accelerated Method for Establishing the Long Term Performance of Polyethylene Gas Pipe Materials", *Polymer Engineering and Science*, Vol. 31, pp. 1693-1700.
- Takaku, A., 1981, "Effect of Drawing on Creep Fracture of Polypropylene Fibers", *Journal of Applied Polymer Science*, Vol. 26, pp. 3565-3573.
- Thornton, J. S., Allen, S. R., and Thomas, R. W., 1997, "Approaches for the Prediction of Long Term Viscoelastic Properties of Geosynthetics from Short Term Tests," *Geosynthetics '97*, IFAI, Long Beach, CA, Vol. 1, pp. 277-291.
- Thornton, J. S., Allen, S. R., Thomas, R. W., and Sandri, D., 1998, "The Stepped Isothermal Method for Time-Temperature Superposition and Its Application to Creep Data of Polyester Yarns," *Sixth International Conference on Geotextiles, Geomembranes, and Related Products*, Atlanta, GA, pp. 699-706.
- Thornton, J. S., Paulson, J., and Sandri, D., 1998, "Conventional and Stepped Isothermal Methods for Characterizing Long-Term Creep Strength of Polyester Geogrids," *Sixth International Conference on Geotextiles, Geomembranes, and Related Products*, Atlanta, GA, pp. 691-698.

## WSDOT Test Method No. 925, Appendix D

### ***Product Specific Testing and Data Interpretation Requirements to Determine $RF_D$ for Geosynthetic Reinforcements***

This appendix provides guidance regarding the performance of long-term product specific durability testing that may be conducted for product acceptance in lieu of the durability index testing as described in “Determination of Long-term Geosynthetic Strength for Initial Product Acceptance” as provided in this protocol. The procedures that follow are required if it is desired to use a value of  $RF_D$  less than the default minimum of 1.3, or to determine  $RF_D$  for environments that are defined as aggressive.

This appendix has been developed to address polypropylene (PP), polyethylene (PE or HDPE), and polyester (PET) geosynthetics. While the chemical and biological durability procedures and criteria provided herein may also be applicable to other polymers (for example, hydrolysis testing as described herein is likely applicable to polyamide and PVA geosynthetics), additional investigation will be required to establish a detailed protocol and acceptance criteria for these other polymers. These other polymers may be considered for evaluation using this protocol once modifications to the chemical/biological durability aspects of this protocol have been developed and are agreed upon by the approval authority.

The product specific durability studies for the determination of  $RF_D$  should be conducted in, or if necessary extrapolated to, the chemical/biological environment anticipated in the reinforced backfill. The anticipated temperature of the environment is also a key variable in assessing the durability of a given product, as temperature can have an exponential effect on the rate of product property change. For the purposes of these guidelines, the effective design temperature is defined as the temperature that is halfway between the average yearly air temperature and the normal daily air temperature for the highest month at the wall site. Higher design temperatures may need to be considered for structures with southern exposures. The effective design temperature will be assumed to be 20° C (68° F), if the design temperature is not specifically identified in the contract specifications. Therefore, determine  $RF_D$  at a temperature of 20°C (68° F) as a minimum. Determination of  $RF_D$  at higher temperatures is optional.

Standards are currently not available for determining the effect of chemical/biological activity on long-term geosynthetic reinforcement strength. However, long-term product specific durability testing can be conducted in a manner that is likely to produce safe results. Geosynthetic durability can be evaluated using either retrieval and testing of geosynthetics in actual installations, or through long-term accelerated laboratory testing. Use of field retrieval data from actual installations requires that the baseline, in terms of tensile strength before and immediately after installation, and possibly other properties, be known with certainty, and that the observation period be of sufficient length to permit extrapolation to the desired design life. The field retrieval approach is in general fraught with practical and technical difficulties (see Allen and Elias, 1996, Elias, 2000, and Elias, 2001). Furthermore, long periods of time may be needed for polyolefins to establish trends that can be extrapolated due to the presence of antioxidants, as no loss in strength will be observed until the antioxidants are used up. Elias (2001) suggests that 30 years of in-service time may be required to obtain adequate observational data for polyolefins, and

even PET products may require 20 years of in-service observations or more to accomplish this. Because of the very long observation periods required, long-term laboratory durability testing is the more practical approach to dealing with the durability issue. An overview of an appropriate laboratory testing approach for each geosynthetic polymer type is provided.

For polyolefin products in which the fibers/ribs do not exhibit micro-cracks or crazes as manufactured, long-term chemical durability testing may consist of elevated temperature oven aging tests to evaluate potential for oxidation effects (FHWA, 1997; Elias, et. al., 1997; Salman, et. al., 1998; Elias, et al., 1999). A magnification of x2,000 to x3,000 may be needed to observe whether or not micro-cracks or crazes are present (Salman, et. al., 1997). If micro-cracks or crazes are present, elevated temperatures may significantly affect the molecular structure of polyolefins in the vicinity of the micro-cracks/crazes, making extrapolation of elevated temperature oxidation behavior to the behavior of the as-manufactured product at ambient temperatures very difficult (Salman, et. al., 1998). For polyolefins in which the fibers/ribs exhibit micro-cracks or crazes, a means other than elevated temperature may be needed to accelerate oxidation behavior. Salman, et. al. (1998) suggest that elevated oxygen concentration and pressure at ambient temperature may prove to be an effective accelerator in lieu of elevated temperature, especially for geosynthetic products in which the fibers/ribs exhibit micro-cracks or crazes as manufactured. In addition, Schröder et al (2002) have performed extensive testing and development of a protocol utilizing elevated oxygen pressure to address this issue. However, long-term validation of the protocol and final development of the protocol as a test standard are yet to be performed.

If oven aging tests are conducted, a forced air oven is strongly recommended to keep the environment inside the oven as uniform as possible during the entire test duration and to keep oxidation products from building up inside the oven, considering the long durations that are likely to be required. Temperature uniformity inside the oven should be maintained at + 1%. An oven with horizontal air flow is recommended. Specimens should be placed in the oven parallel to the air flow and spaced no closer together than 13 mm (0.5 in.) apart (Allen and Elias, 1996; Elias, et al., 1999). The specimens should not be framed to prevent shrinkage, if shrinkage occurs, as doing this will create load in the specimen, making the resulting data difficult to interpret. Note that oxidation testing using forced air ovens will produce conservative estimates of long-term product strength due to the rapid air circulation and the relatively high oxygen content in the oven relative to the oxygen content in the ground. If the geosynthetic supplier wishes to submit data at a lower oxygen content than that of air (approximately 21% O<sub>2</sub>), use of such data for approval of a given product may require that the structure be declared experimental, requiring that instrumentation be placed in the ground to verify the actual oxygen content in the structure backfill. Alternatively, the geosynthetic supplier could submit data from previously constructed structures with similar backfill in which the actual oxygen content in the structure backfill was measured.

For polyesters, long-term chemical durability testing should consist of elevated temperature immersion tests to evaluate potential for hydrolysis effects. A reactor similar to that illustrated in Elias, et al. (1999) is recommended for incubating the geosynthetic specimens. A description of the test protocol is provided by Elias, et al. (1999). The reactor should be capable of maintaining temperature uniformity (+ 1%) and stability during long-term use. A minimum solid/liquid ratio of 1:40 should be used to size the reactor and to determine the maximum number of specimens that can be placed in the reactor. Measures should be taken to minimize possibilities for oxidation and reaction with carbon dioxide during the long-term incubation (e.g., replace any air inside the reactor with nitrogen, use de-aired water, keep system well sealed, etc.). Specimens should be suspended in the solution on a hanger made of a material that will not react with or contaminate the immersion fluid and specimens (e.g., Teflon, stainless steel, etc.). The specimens should not be framed to prevent shrinkage, if shrinkage occurs so that an unknown amount of tension is not placed on the specimens. Specimens should each be separated by a distance of at least 13 mm (0.5 in.). The solution should be intensively stirred to ensure solution uniformity. For coated polyester products, the immersion tests should be conducted without the coating or the coated specimen ends should not be recoated (i.e., the ends of the core polymer should be left exposed to the immersion liquid). Elevated temperatures should be used to accelerate the degradation process, which allows the data to be extrapolated to the desired design life. Hydrolysis data should be submitted for the product at a pH of approximately 7 (i.e., neutral conditions - distilled water), at a pH of 9 or more, and at a pH of 4 or less to facilitate the determination of  $RF_D$ .  $RF_D$  should be determined at a pH of 7 and at an alkaline pH (i.e., a pH of 9) as a minimum. If very acidic soils are anticipated (i.e., a pH near the bottom limit of pH = 4 for conditions defined as nonaggressive),  $RF_D$  should be determined at a pH of 4 as well.

Note that EPA 9090 testing, or the ASTM equivalent (ASTM D5322), is not considered adequate for a laboratory testing program to provide an estimate of  $RF_D$ . However, EPA 9090 or ASTM D5322 testing can be used as a first cut screening tool. That is, if any significant degradation of the strength of the product in question is observed for the chemical environment tested, the product would be disqualified for use in that chemical environment unless longer term testing conducted in accordance with this appendix is performed. EPA 9090 testing (or ASTM D5322) could also be used verify the effects of certain environmental variables which are known, based on the literature, to not significantly affect the given material. For example, low or high pH is known, based on the literature, to have little effect on polyolefins. This type of testing could be used to verify that the low or high pH does not affect the tensile strength of a polyolefin product, to allow that product to be used in environments that have a pH outside the range defined as a nonaggressive environment.

The long-term chemical durability testing program should be conducted and interpreted using the following guidelines:

- Incubation temperatures for the testing should be high enough to adequately accelerate the degradation process but below any major transitions in polymer behavior (e.g., glass transition, melting). Maximum recommended test temperatures to avoid major transitions are on the order of 70 to 75° C for polypropylene, high density polyethylene, and polyester, except as discussed above for polyolefin products which have micro-cracks or crazes as manufactured. However, exposure to temperatures near the upper end of these ranges could affect the stress-strain behavior of the material due to loss of molecular orientation, or possibly other effects that are not the result of chemical degradation. Therefore, care needs to be exercised when interpreting results from strength testing after exposure to temperatures near the maximum test temperatures indicated above. In general, if the stiffness of the material after exposure to the environment is significantly different from that of the virgin material, the stress-strain properties, and possibly the strength, of the material may have been affected by the exposure temperature in addition to the chemical environment. If the stiffness has been affected, the cause of the stiffness change should be thoroughly investigated to determine whether or not the change in stiffness is partially or fully due to the effect of temperature, or alternatively not use the data obtained at and above the temperature where the stiffness was affected. It is additionally recommended that the Arrhenius plot of the data be checked for linearity (see the discussion of Arrhenius modeling which follows). As a minimum, two to three data points above and below the suspected transition should be obtained and the plot checked for linearity through the entire range of temperatures, if it is desired to validate the use of data above the suspected transition for Arrhenius modeling and extrapolation purposes.
- A minimum of three to four test temperatures are recommended, typically spaced monotonically at 10° C increments (e.g., see ASTM D3045), except as discussed above for some polyolefin products.
- At the lowest test temperature (e.g., 30 to 50° C), incubation times of 2 to 4 years should be anticipated to get data adequate for long-term extrapolation.
- Enough retrievals (e.g., a minimum of three to four retrievals) should be made at a given test condition to adequately define the property loss as a function of incubation time.
- As a minimum, degradation should be tracked using the tensile strength of the specimens retrieved from the incubation chambers. Full wide width (ASTM D4595 or ASTM D6637) specimens are preferred; however, single rib or yarn specimens can be used.
- It is also recommended that degradation be tracked by chemical means, if possible, as well as through the use of scanning electron microscope (SEM) micrographs to verify the significance of the mechanical property degradation observed.



- The statistical variation of the measured properties after degradation are likely to be greater than what would be observed for the virgin material. This may require that the number of specimens per retrieval be greater than what the property variation for the virgin material would indicate.
- Extrapolation of chemical durability data for polymers typically utilizes an Arrhenius approach, though there is evidence which suggests that the Arrhenius model does not always work well for geosynthetics. Assuming Arrhenius modeling is appropriate, the slope of the strength degradation versus time plots (transformed mathematically to be linear through zero, first, or second order Arrhenius equations) can be used to characterize the degradation behavior as a function of temperature, allowing the slope at the desired design temperature to be estimated through the Arrhenius extrapolation. The equation order which best fits the data should be used (see Salman, et. al., 1998, for details). The strength retained at a given time at the design temperature can be calculated directly from the linear equation with the extrapolated slope. Note that Arrhenius modeling could also be conducted as a function of reactant (oxygen) concentration and pressure instead of temperature (Shelton and Bright, 1993; Salman, et. al., 1998). The extrapolation concept would be similar to that used for temperature. See Shelton and Bright (1993), Salman, et. al. (1997), and Salman, et. al. (1998), Elias, et al. (1999), Elias (2000) for guidance on Arrhenius modeling techniques as applied to geosynthetics. Also note that since the extrapolation is being conducted over several log cycles of time, uncertainty in the data should be considered when determining the retained strength at the design life and design environment.
- For polyolefin oxidation, Arrhenius modeling will likely need to be conducted in two steps, as there are two main phases in the oxidation process for polyolefins: 1) the induction phase, where antioxidant consumption is the primary activity and little, if any, product strength loss occurs, and 2) the main polymer oxidation phase, where oxidative degradation of the polyolefin occurs, resulting in strength loss, and can generally be described by the kinetics of a Basic Auto-oxidation Scheme (Salman, et. al., 1997; Elias, et al., 1999). An Arrhenius model for the first phase should be developed so that the induction period  $t^{\text{ind}}$  at the design temperature or reactant (i.e., oxygen) concentration can be estimated. A second Arrhenius model should then be developed using only the data after the induction period, and time in this case would begin at the end of the induction period at each temperature or reactant concentration tested. This second Arrhenius model is then extrapolated to the design temperature or reactant concentration to estimate the strength loss anticipated at the desired design life minus the induction period. Analysis of the remaining antioxidant content provides an additional method of measuring the duration of Step 1, particularly at lower temperatures and long durations, since changes in the antioxidant content take place ahead of the reduction in strength. Note that if the estimated induction period at the design environment is greater than the desired design life, this second phase Arrhenius modeling is unnecessary.

- Once the tensile strength at a given design life and design temperature has been estimated from the test data, determine  $RF_D$  as follows:

$$RF_D = \frac{T_{lot}}{T_D} \quad (D-1)$$

where,  $T_{lot}$  is the average lot specific ultimate tensile strength for the lot of material used for the durability testing, and  $T_D$  is the extrapolated (i.e., to the required design life) lot specific tensile strength after degradation based on the laboratory aging tests. In no case should  $RF_D$  be less than 1.1.

Biological degradation has not proved a serious factor in the service life of geosynthetics. This is because the high molecular weight polyethylene, polyester, polypropylene and polyamide used are not easily broken down by bacteria and fungi. The high tensile strength of soil reinforcements prevents them from damage by roots of burrowing animals such as rabbits. For this reason it is not in general necessary to apply consider biological degradation in defining  $RF_D$ . However, the possibility of biological degradation should be reviewed if new polymers other than those described are used. Biological durability, if specifically requested by the approval authority, should be evaluated based on ASTM D3083-89, except the test should be modified to use ASTM D4595 or ASTM D6637 as the tensile test method. If any significant tensile strength loss is observed, as determined using ASTM D4595 or ASTM D6637, additional longer term testing should be performed before the product is further considered for use in reinforcement applications (see Bright, 1993).

If, as an alternative to long-term laboratory testing, the geosynthetic manufacturer prefers to submit data from long-term field retrievals, the following requirements must be met:

- A minimum of three retrievals must be obtained over a minimum time period adequate to permit extrapolation to the required design life (i.e., the first retrieval is taken right after installation, the second retrieval is taken at some time during the middle of this period, and the third retrieval is taken at the end of the minimum study period).
- The retrieved samples shall be evaluated both physically and chemically to determine changes in strength, fiber/yarn/rib appearance, and polymer chemistry. Lot specific baseline data for the exhumed geosynthetic regarding strength and polymer properties must be available for comparison. The soil environment in which the geosynthetic was placed must also be well defined in terms chemistry, moisture, temperature, gradation, and approximate geosynthetic stress level. Enough specimens for each retrieval must be taken to account for statistical variance in the properties measured. See Elias (2000, 2001) for a more detailed description of the procedures required to obtain the needed information to determine  $RF_D$  using this approach.
- The polymer and physical characteristics of the exhumed material must meet the requirements for use in determining  $RF_D$  for “similar” products as described later in this appendix.

**Note 1:** *Chemical degradation of geosynthetics is a result of both environmental factors and polymer compositional factors. For a given polymer type, one can expect the greatest amount of chemical degradation to occur, in general, with polymers which have low molecular weights, low percent crystallinity, low density, and low draw ratios (Elias, 1990). Polymer additives also influence the degradation rate. Regarding environmental factors, one can expect the greatest amount of degradation to occur, in general, at relatively high temperatures, in moderate to high moisture conditions, in soils which are active chemically (especially in terms of pH and certain types of ions present), and with the geosynthetic under stress (Elias, 1990). Thickness of the polymer fibers may also have a strong influence on the degradation rate, as degradation mechanisms are dependent on diffusion processes or exposure and removal of surface material (Wrigley, 1987). Key chemical degradation mechanisms in typical soil environments include oxidation, hydrolysis, and environmental stress cracking (ESC).*

*The oxidation reaction can either be initiated by ultraviolet (UV) radiation or thermal energy. The rate of oxidation will be governed by chemical rate kinetics and by the rate of diffusion of the oxygen, the antioxidants and the degradation products. Diffusion (or migration) is frequently the controlling factor. Where the geosynthetic is buried, thermally activated oxidation is of most interest. UV activated oxidation is of importance only where the geosynthetic is exposed to light, such as at the wall face. In general, the wall face is covered from light with a permanent facing. Of the polymers used in geosynthetics, relatively speaking, polypropylene (PP) is potentially the most susceptible to oxidation, followed by high density polyethylene (HDPE) and polyester (PET) which have a relatively low susceptibility. Though in actuality a rather complex reaction, conceptually, polyolefin (i.e., PP and HDPE) oxidation is the reaction of free radicals within the polymer with oxygen, resulting in breakdown and/or crosslinking of the molecular chains and embrittlement of the polymer.*

*Antioxidants are typically added to the polymer (sometimes multiple types are added to increase effectiveness) to prevent oxidation during processing and use. Broad classes of antioxidants often used in geosynthetics include phenolic stabilizers and hindered amine light stabilizers (HALS). As the antioxidants are used up, resistance of the polymer to oxidation will decrease. The rate of polymer oxidation is dependent on how much and what type of antioxidant is present initially, at what rate it is used up, and how well it is distributed within the polymer (Van Zanten, 1986). Environmental factors which affect the rate of oxidation include temperature, oxygen concentration which in soil can vary from 21% in gravels at shallow depth to on the order of 1% in fine-grained soils at deeper depths (Yanful, 1993; Yanful, et. al., 1993), and the presence of transition metal ions such as iron (most common) or copper which act as a catalyst and accelerate the oxidation reaction. Thermal oxidation at typical in-soil temperatures appears to be quite slow.*

*Of the polymers mentioned above, only PET is potentially susceptible to hydrolysis. Hydrolysis occurs when water molecules react with the polymer molecules, resulting in chain scission, reduced molecular weight, and strength loss. Hydrolysis is simply the very slow inverse reaction of the synthesis of PET when water is present. The specifics of the reaction vary depending on the pH of the liquid. This results in high pH (alkaline) hydrolysis being relatively rapid, whereas neutral or low pH conditions can result in a slow hydrolysis rate. The rate of hydrolysis is also highly temperature dependent and*

can become relatively rapid at high temperatures in the vicinity of the glass transition temperature or above for the polymer, which is on the order of 70° C to 80° C (160° F to 180° F). The polymer does not need to be submerged for hydrolysis to occur, as hydrolysis can occur in moderate to high humidity conditions, though the reaction rate becomes slower as the humidity decreases (McMahon, et. al., 1959).

Hydrolysis appears to be the result of both a surface erosional phenomenon as well as a diffusional process of water to the polymer fiber core. These two phenomena have given rise to the terms “outer” and “inner” hydrolysis. Outer, or surficial, hydrolysis is dominant in high pH conditions and is characterized by loss in fiber cross-sectional area with minimal reduction in the molecular weight of the polymer that remains (Anderson, et. al., 1992; Jailloux, et. al., 1992). Inner, or diffusional controlled hydrolysis is dominant in neutral and acidic conditions and is characterized by significant losses in molecular weight of the polymer with minimal surficial erosion or damage (Anderson, et. al., 1992; Jailloux, et. al., 1992).

Rupture of a polymer when under stress is either ductile or brittle in nature. The ductile failure mode occurs when stresses are high enough to cause tie molecules to stretch out, lamellae to separate and start unfolding, resulting in fracture of the spherulites and plastic flow of the molecular structure (Lustiger, 1983). When failure occurs in a brittle manner, stress levels are usually lower, allowing sufficient time for tie molecules to slowly disentangle themselves from adjacent spherulites, initiating crack formation followed by slow crack growth (Bright, 1993).

ESC is the result of an accelerated crack initiation and growth process occurring when a polymer is subjected concurrently to a particular chemical environment and long-term stress. This accelerated crack initiation and growth process can result in premature brittle failure. ESC results in molecular chain disentanglement rather than chain breakage or chemical change.

Evaluation of ESC has been focused on polyethylene due to its use in various critical applications (e.g., telephone transmission cables, natural gas pipe) and the potential sensitivity of some polyethylenes to this phenomenon. The literature indicates that other polymers used for geosynthetics may also experience some sensitivity to this phenomenon (Bright, 1993).

The results of previous studies show that polyethylene resistance to ESC can be improved by increasing its average molecular weight, decreasing its molecular weight distribution, increasing its crystalline content, reducing the crystallite and/or spherulite size, increasing the degree of orientation, and using copolymerization (Wrigley, 1987). Therefore, the potential for ESC in a given polymer can be controlled.

ESC is closely related to the more general phenomenon of stress cracking. The difference between the two is that the chemical present for ESC accelerates the chain disentanglement process, whereas in stress cracking no accelerating chemical is present. Chemicals identified in the literature that can accelerate the stress cracking process include water, weak acids and bases, alcohols, metallic soaps, and solvents (Wrigley, 1987). Water, and to some extent weak acids and bases, are “chemicals” which need to be considered for ESC in typical in-soil environments.

*An extensive long-term laboratory study of oxidation and hydrolysis as applied to geosynthetic reinforcement has been carried out (Elias, et al., 1999). Field studies have been carried out to evaluate many of the longer-term installations in which some baseline data was available (Elias, 2001). In most cases, degradation has been minimal, if it is even significant enough be measurable. These laboratory studies appear to corroborate the lack of degradation that has been observed in the field (Elias, 2001). The protocols for oxidation and hydrolysis evaluation provided in this appendix, as well as the durability evaluation criteria provided elsewhere in Standard Practice T925, have been developed based on results from the laboratory and field studies conducted by Elias, et al. (1999) and Elias (2001).*

### **Use of Durability Data from “Similar” Products**

Long-term chemical/biological durability data obtained from tests performed on older product lines, or other products within the same product line, may be applied to new product lines, or a similar product within the same product line, if one or both of the following conditions are met:

- The chemical and physical characteristics of tested products and proposed products are shown to be similar. Research data, though not necessarily developed by the product manufacturer, should be provided which shows that the minor differences between the tested and the untested products will result in equal or greater chemical/biological degradation resistance for the untested products.
- A limited testing program is conducted on the new or similar product in question and compared with the results of the previously conducted full testing program.

For polyolefins, similarity could be judged based on molecular weight and structure of the main polymer (i.e., is the polymer branched or crosslinked, is it a homopolymer or a blend, percent crystallinity, etc.), percentage of material reprocessed, tenacity of the fibers and processing history, and polymer additives used (i.e., type and quantity of antioxidants or other additives used). For polyesters and polyamides, similarity could be judged based on molecular weight or intrinsic viscosity of the main polymer, carboxyl end group content, percent crystallinity, or other molecular structure variables, tenacity of the fibers and processing history, percentage of material reprocessed or recycled, and polymer additives used (e.g., pigments, etc.). The untested products should also have a similar macrostructure (i.e., woven, nonwoven, extruded grid, needlepunched, yarn structure, etc.) and fiber dimensions (e.g., thickness) relative to the tested products. It should be noted that percent crystallinity is not a controlled property and there is presently no indication of what an acceptable value for percent crystallinity should be.

For chemical durability evaluation, the limited testing program could consist of laboratory aging tests with a 1,000 to 2,000 hour incubation period in the same environment used for the full testing program conducted previously, conducted at a temperature near but slightly below any major property transitions. These limited durability test results must show that the durability performance of the new or similar product is equal to or better than the performance of the product previously tested. If so, the results from the full testing program on the older or similar product could be used for the new/similar product. If not, then a full testing and evaluation program for the new product should be conducted.

## References

- AASHTO, 2002, *Standard Specifications for Highway Bridges*, American Association of State Highway and Transportation Officials, Seventeenth Edition, Washington, D.C., USA, 686 p.
- Allen, T. M., and Elias, V., 1996, *Durability of Geosynthetics for Highway Applications - Interim Report*, FHWA-RD-95-016, Washington, D.C.
- Anderson, P. L., Jailloux, J.-M., and White, D. F., 1992, "Testing Durability of Polyester to Be Used in Earth-Reinforced Structures," *Earth Reinforcement Practice*, Balkema, Rotterdam, pp. 9-12.
- American Society for Testing and Materials (ASTM), 1994, *Annual Book of Standards*, Vol. 8.04, Elastic Pipe and Building Materials, ASTM, Philadelphia, PA, USA.
- American Society for Testing and Materials (ASTM), 1994, *Annual Book of Standards*, Vol. 4.08 and 4.09, Soil and Rock, ASTM, Philadelphia, PA, USA.
- Bright, D. G., 1993, "The Environmental Stress Cracking of Polymers Used in Geosynthetic Products," *Geosynthetics '93 Conference*, Vancouver, B.C., pp. 925-934.
- Elias, V., 1990, *Durability/Corrosion of Soil Reinforced Structures*, FHWA/RD-89/186, Federal Highway Administration, Washington, D.C.
- Elias, V., 2000, *Corrosion/Degradation of Soil Reinforcements for Mechanically Stabilized Earth Walls and Reinforced Soil Slopes*, FHWA-NHI-00-044, Federal Highway Administration, Washington, D.C.
- Elias, V., 2001, *Long-Term Durability of Geosynthetics Based on Exhumed Samples from Construction Projects*, FHWA Report FHWA RD-00-157, 53 pp.
- Elias, V., Salman, A., Juran, I., Pearce, E., and Lu, S. 1999, *Testing Protocols for Oxidation and Hydrolysis of Geosynthetics*, FHWA Report FHWA RD-97-144, 200 pp.
- Elias, V., DiMaggio, J., and DiMillio, A., 1997, "FHWA Technical Note on the Degradation-Reduction Factors for Geosynthetics," *Geotechnical Fabrics Report*, Vol. 15, No. 6, pp. 24-26.
- Federal Highway Administration (FHWA), 1997, "Degradation Reduction Factors for Geosynthetics," *Federal Highway Administration Geotechnology Technical Note*.
- Jailloux, J.-M., Anderson, P. L., and Thomas, R., 1992, "Chemical Compatibility Studies of Polyester Fibers and Yarns to Be Used in Geocomposites," *Geotextiles and Geomembranes*, Vol. 11, No. 3, pp. 277-290.
- Jewell, R.A. and Greenwood, J.H., 1988, "Long-Term Strength and Safety in Steep Soil Slopes Reinforced by Polymer Materials", *Geotextiles and Geomembranes*, Vol. 7, Nos. 1 and 2, pp. 81-118.
- Lustiger, A., 1983, "The Molecular Mechanism of Slow Crack Growth in Polyethylene," *Proceedings, Eighth Plastic Fuel Gas Pipe Symposium*, American Gas Association: Arlington, Virginia, pp. 54-56.

- McMahon, W., Birdsall, H. A., Johnson, G. R., and Camilli, C. T., 1959, "Degradation Studies of Polyethylene Terephthalate," *Journal Chemical Engineering Data*, Vol. 4, No. 1, pp. 57-79.
- Murray, R. T. and Farrar, D. M., 1988, "Temperature Distributions in Reinforced Soil Retaining Walls," *Geotextiles and Geomembranes*, No. 7, pp. 33-50.
- Salman, A., Elias, V., Juran, I., Lu, S., and Pearce, E., 1997, "Durability of Geosynthetics Based on Accelerated Laboratory Testing," *Geosynthetics '97*, IFAI, San Diego, CA, pp. 217-234.
- Salman, A., Elias, V., and DiMillio, A., 1998, "The Effect of Oxygen Pressure, Temperature, and manufacturing Processes on Laboratory Degradation of Polyolefin Based Geosynthetics," *Sixth International Conference on Geotextiles, Geomembranes, and Related Products*, Atlanta, GA (in press).
- Schröder H. F., Bahr H., Lorenz E., Kneip E., Schmücking I., Zeylanov E. B., "Resistance of polyolefin geosynthetics to oxidation – a new accelerated test working at elevated oxygen pressure. Geosynthetics – State of the art – Recent developments," eds Delmas P., and Gourc J P., *Proceedings of the Seventh International Conference on Geosynthetics*, Nice, France. Balkema, Lisse, Netherlands, 2002, pp 1455-1458.
- Shelton, W. S., and Bright, D. G., 1993, "Using the Arrhenius Equation and Rate Expressions, to Predict the Long-Term Behavior of Geosynthetic Polymers," *Geosynthetics '93 Conference*, Vol. 2, Vancouver, B.C., pp. 789-802.
- Van Zanten, V., ed., 1986, *Geotextiles and Geomembranes in Civil Engineering*, Wiley-Halsted.
- Wisse, J.D.M., Broos, C.J.M., and Boels, W.H., 1990, "Evaluation of the Life Expectancy of Polypropylene Geotextiles Used in Bottom Protection Structures Around the Ooster Schelde Storm Surge Barrier - A Case Study", *Proceedings of the Fourth International Conference on Geotextiles, Geomembranes, and Related Products*, The Hague, Netherlands, pp. 679-702.
- Wrigley, N. E., 1987, "Durability and Long-Term Performance of Tensar Polymer Grids for Soil Reinforcement," *Materials Science and Technology*, Vol. 3, pp. 161-170.
- Yanful, E. K., 1993, "Oxygen Diffusion Through Soil Covers on Sulphidic Mine Tailings," *ASCE Journal of Geotechnical Engineering*, Vol. 119, No. 8, pp. 1207-1228.
- Yanful, E. K., Riley, M. D., Woyshner, M. R., and Duncan, J., 1993, "Construction and Monitoring of a Composite Soil Cover on an Experimental Waste-Rock Pile near Newcastle, New Brunswick, Canada," *Canadian Geotechnical Journal*, No. 30, pp. 588-599.







## WSDOT Test Method T 926

### Geogrid Brittleness Test

#### Purpose and Scope

The purpose of this test to determine whether or not the product is likely to exhibit brittle behavior (rapid crack growth) when bent. This test is applicable to geogrids made of High Density Polyethylene (HDPE), polypropylene (PP) fiberglass, or other relatively stiff geogrid materials.

#### Equipment

The testing device shall have two planes tangent to a  $0.5 \pm 0.025$  inch radius curve fixed at a  $90 \pm 2$  degree angle, such as shown in Figure 1.

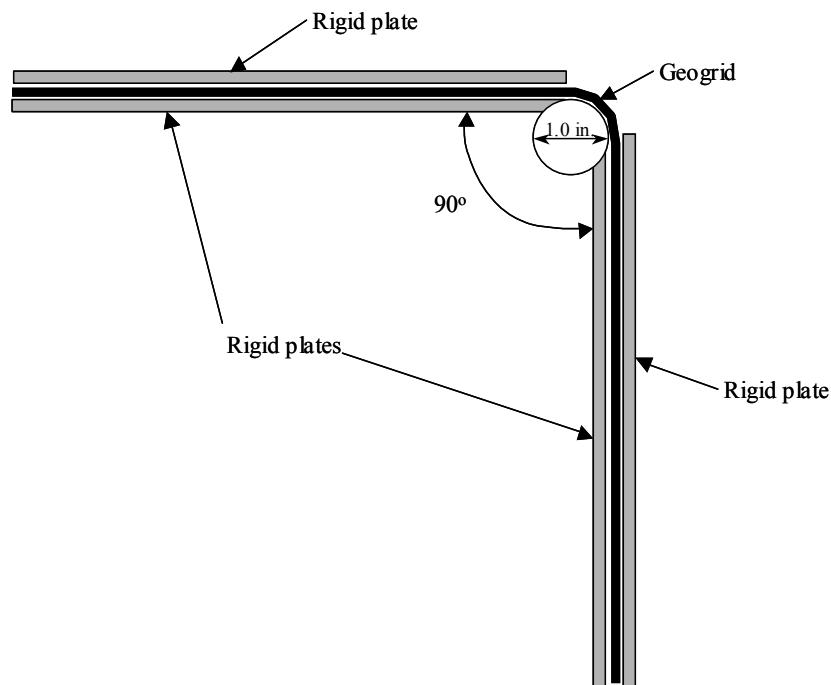

Geogrid bend test setup.  
Figure 1

#### Sampling and Specimens

Sampling shall be in conformance to WSDOT Test Method 914.

Six specimens shall be taken at random locations throughout the sample. The specimens shall be one rib wide, with a minimum length of 12 inches, and approximately 2 inches of the cross-ribs shall remain attached to the rib being tested. No specimen should be located closer than 6 inches from the edge of the sample.

## Procedure

The laboratory shall be  $70\pm 4$  degrees F. Samples shall be allowed to remain at the laboratory temperature for a minimum of 1 hour before testing.

Place the geogrid rib on the bending template as shown in Figure 1. Apply the top cover plate on the geogrid, and apply uniform pressure on the plate and the geogrid specimen. Once the upper plate is in position and fixed, place the vertical cover plate over the geogrid, applying uniform pressure, causing the geogrid rib to conform to the 0.5 inch radius in approximately 3 seconds. Hold the geogrid in place for a minimum of  $10\pm 1$  seconds.

If any geogrid specimen breaks or otherwise exhibits cracking the full width of the rib or the cracking extends into the cross-rib at the bend at any time during the 10 second hold period, the geogrid sample has failed the test.

## Report

Identify the number of specimens that failed, if any, in the sample. Close-up photographs of any failed specimen shall be taken and maintained at the testing lab until the contract is completed.

# WSDOT Test Method for ASTM C 939<sup>1</sup>

## ***Flow of Grout for Preplaced-Aggregate Concrete (Flow Cone Method)***

This standard is issued under the fixed designation C 939; the number immediately following the designation indicates the year of original adoption or, in the case of revision, the year of last revision. A number in parentheses indicates the year of last reapproval. A superscript epsilon ( $\epsilon$ ) indicates an editorial change since the last revision or reapproval. *This specification has been approved for use by agencies of the Department of Defense.*

### **1. Scope**

- 1.1 This test method covers a procedure, used both in the laboratory and in the field, for determining the time of efflux of a specified volume of fluid hydraulic cement grout through a standardized flow cone and used for preplaced-aggregate (PA) concrete; however, the test method may also be used for other fluid grouts.
- 1.2 It is for use with neat grout and with grouts containing fine aggregate all passing a No. 8 (2.36 mm) sieve.
- 1.3 This test method is intended for use with grout having an efflux time of 35 s or less.
- 1.4 When efflux time exceeds 35 s, flowability is better determined by flow table, found in Test Method C 109, using 5 drops in 3 s.
- 1.5 The values stated in SI units are to be regarded as the standard.
- 1.6 *This standard does not purport to address all of the safety concerns, if any, associated with its use. It is the responsibility of the user of this standard to establish appropriate safety and health practices and determine the applicability of regulatory limitations prior to use.*

### **2. Referenced Documents**

#### 2.1 ASTM Standards:

C 109/C109M Test Method for Compressive Strength of Hydraulic Cement Mortars  
(Using 2 in or 50 mm Cube Specimens)

C 938 Practice for Proportioning Grout Mixtures for Preplaced-Aggregate Concrete

### **3. Summary of Test Method**

- 3.1 The time of efflux of a specified volume of grout from a standardized flow cone is measured.

### **4. Significance and Use**

- 4.1 This test method is applicable to the determination of the fluidity of various fluid grout mixtures.

### **5. Interferences**

- 5.1 The presence of solid particles retained on the No. 8 (2.36 mm) sieve or lumps of unmixed material in the grout may cause the grout to flow unevenly through the discharge tube of the flow cone or stop the flow completely. Uneven flow will result in slower transit of the grout, thereby indicating a false consistency.

---

<sup>1</sup> This Test Method is based on ASTM C 939-97.

## 6. Apparatus

6.1 *Flow Cone*. The body and discharge tube can be stainless steel, cast aluminum, or other essentially non-corroding metal.

**Note 1:** Cones with high-density polyethylene bodies are acceptable for field use in situations where precision as described in this test method is not required.

6.2 *Receiving Container*, capacity 2000 mL, minimum.

6.3 *Ring Stand* or other device, capable of supporting the flow cone in a vertical, steady position over the receiving container.

6.4 *Level*, carpenter's or similar.

6.5 *Stop Watch*, least reading of not more than 0.2 s.

6.6 *Grout Mixer*, conforming to Practice C 938.

## 7. Test Sample

7.1 The grout test sample shall be in excess of 1725 mL and shall be representative of the grout in the mixer.

7.2 When sampling and testing is being done for the purpose of proportioning or comparing mixes or for qualifying materials, the temperature of the dry materials and mixing water shall be such that the temperature of the freshly mixed grout is  $73.4 \pm 3^{\circ}\text{F}$  ( $23 \pm 1.7^{\circ}\text{C}$ ), unless otherwise specified.

## 8. Calibration of Apparatus

8.1 Mount the flow cone firmly in such a manner that it is free of vibration. Level the top to assure verticality. Close the outlet of the discharge tube with a finger or a stopper. Introduce  $1725 \pm 5$  mL of water into the cone. Adjust the point gage to indicate the level of the water surface. Then allow the water to drain.

8.2 Before first use of the flow cone with grout and periodically thereafter, check the accuracy of the cone by filling it with water as described in 8.1. After checking or adjusting the point gage, start the stop watch and simultaneously remove the finger. Stop the watch at the first break in the continuous flow of water. The time indicated by the stop watch is the time of efflux of water. If this time is  $8.0 \pm 0.2$  s, the cone may be used for determining the time of efflux of grout.

**Note:** It is imperative that the water be completely still prior to allowing it to flow from the cone, any movement will cause the time of efflux to increase.

## 9. Procedure

- 9.1 Moisten the inside of the flow cone by filling the cone with water and, 1 min before introducing the grout sample, allow the water to drain from the cone. Close the outlet of the discharge tube with a finger or a stopper. Introduce the grout into the cone until the grout surface rises to contact the point gage, start the stop watch, and simultaneously remove the finger or stopper. Stop the watch at the first break in the continuous flow of grout from the discharge tube, then look into the top of the cone; if the grout has passed sufficiently, such that light is visible through the discharge tube, the time indicated by the stop watch is the time of efflux of the grout. If light is not visible through the discharge tube, then the use of the flow cone is not applicable for grout of this consistency. At least two tests having times of efflux within 1.8 s of their average shall be made for each grout mixture.
- 9.2 The test for time of efflux shall be made within 1 min of drawing of the grout from the mixer or transmission line. When grout is being placed over a significant period of time, the time of efflux may be determined at selected intervals to demonstrate that the consistency is suitable for the work.

## 10. Report

10.1 Report the following information:

- 10.1.1 Identification of sample,
- 10.1.2 Identification of materials in the sample, the proportions, and whether laboratory prepared or taken from the field production mix,
- 10.1.3 Average time of efflux to nearest 0.2 s and time interval from completion of mixing at which the test was made, and  
**Note 2:** Other means of indicating grout level may be used as long as accurate indication of grout level on volume is obtained.
- 10.1.4 Temperature, ambient and of the sample at the time of test.

## 11. Precision and Bias

- 11.1 Precision – The following within-laboratory, multiple-operator precision applies. The single laboratory standard deviation has been found to be 0.88 s. Therefore, results from two properly conducted tests on the same material should not differ by more than 2.49 s.
- 11.2 *Bias* – No statement on bias can be prepared because there are no standard reference materials.

## 12. Keywords

- 12.1 flow cone; grout; preplaced—aggregate concrete; time of efflux



## **WSDOT FOP for ASTM C1231**

### ***Use of Unbonded Caps in Determination of Compressive Strength of Hardened Cylindrical Concrete Specimens***

WSDOT has adopted the published ASTM C1231.

*AASHTO Test Methods cannot be included in Materials Manual due to copyright infringement.*

*WSDOT employees can access AASHTO and ASTM test methods in the following web address:*

[wwwi.wsdot.wa.gov/tools-services/library-services/access-aashto-publications-and-astm-aci-or-sspc-standards](http://wwwi.wsdot.wa.gov/tools-services/library-services/access-aashto-publications-and-astm-aci-or-sspc-standards)

*Non-WSDOT employees can order AASHTO's Standard Specifications for Transportation Materials and Methods of Sampling and Testing, using the following web address:*

<https://store.transportation.org>





## Performance Exam Checklist

### ASTM C 1231

#### *Use of Unbonded Caps in Determination of Compressive Strength of Hardened Cylindrical Concrete Specimens*

Participant Name: \_\_\_\_\_ Exam Date: \_\_\_\_\_

Record the symbols "P" for passing or "F" for failing on each step of the checklist.

Procedure Element	Trial 1	Trial 2
1. The tester has a copy of the current procedure on hand?	_____	_____
2. All equipment is functioning according to the test procedure, and if required has the current calibration/standardization/check and maintenance tags present?	_____	_____
3. Depressions in specimen ends checked?	_____	_____
4. Neoprene pads meet dimensional requirements?	_____	_____
5. Neoprene pads do not exceed the maximum reuse limits?	_____	_____
6. Unbonded caps not used for concrete with compressive strength below 1500 psi or above 12,000 psi?	_____	_____
7. If recommended, pads and specimen ends dusted with corn starch or talcum powder prior to testing?	_____	_____

Comments: First Attempt: Pass \_\_\_\_\_ Fail \_\_\_\_\_ Second Attempt: Pass \_\_\_\_\_ Fail \_\_\_\_\_

Examiner Signature: \_\_\_\_\_ WAQTC #: \_\_\_\_\_



# WSDOT FOP for ASTM C 1611

## *Standard Test Method for Slump Flow of Self-Consolidating Concrete*

### 1. Scope

- 1.1 This test method covers the determination of slump flow of self-consolidating concrete.
- 1.2 The values stated in either inch-pound units or SI units are to be regarded separately as standard. Within the text, the SI units are shown in brackets. The values stated in each system are not exact equivalents; therefore, each system shall be used independently of the other. Combining values from the two systems may result in nonconformance with the standard.
- 1.3 This standard does not purport to address all of the safety concerns, if any, associated with its use. It is the responsibility of the user of this standard to establish appropriate safety and health practices and determine the applicability of regulatory limitations prior to use. (**Warning:** Fresh hydraulic cementitious mixtures are caustic and may cause chemical burns to skin and tissue upon prolonged exposure.)
- 1.4 The text of this standard references notes and footnotes that provide explanatory material. These notes and footnotes (excluding those in tables and figures) shall not be considered as requirements of the standard.

### 2. Referenced Documents

#### 2.1 ASTM Standards

C 143/C 143M

Test Method for Slump of Hydraulic-Cement Concrete

C 172 Practice for Sampling Freshly Mixed Concrete

C 173/C 173M

Test Method for Air Content of Freshly Mixed Concrete by the Volumetric Method

C 670 Practice for Preparing Precision and Bias Statements for Test Methods for Construction Materials

#### 2.2 AASHTO Standards

T 119M/T 119

Standard Test Method for Slump of Hydraulic-Cement Concrete

T 347 Slump Flow of Self-Consolidating Concrete (SCC)

#### 2.3 WAQTC Standards

TM 2

Sampling Freshly Mixed Concrete

### 3. Terminology

#### 3.1 Definitions of terms specific to this standard:

- 3.1.1 *halo, n* – An observed cement paste or mortar ring that has clearly separated from the coarse aggregate, around the outside circumference of concrete after flowing from the slump cone.
- 3.1.2 *spread, n* – The distance of lateral flow of concrete during the slump-flow test.
- 3.1.3 *stability, n* – The ability of a concrete mixture to resist segregation of the paste from the aggregates.
- 3.1.4 *viscosity, n* – Resistance of a material to flow under an applied shearing stress.

### 4. Summary of Test Method

- 4.1 A sample of freshly mixed concrete is placed in a mold shaped as the frustum of a cone. The concrete is placed in one lift without tamping or vibration. The mold is raised, and the concrete allowed to spread. After spreading ceases, two diameters of the concrete mass are measured in approximately orthogonal directions, and slump flow is the average of the two diameters.

### 5. Significance and Use

- 5.1 This test method provides a procedure to determine the slump flow of self-consolidating concrete in the laboratory or the field.
- 5.2 This test method is used to monitor the consistency of fresh, unhardened self-consolidating concrete and its unconfined flow potential.
- 5.3 It is difficult to produce self-consolidating concrete that is both flowable and nonsegregating using coarse aggregates larger than 1 in (25 mm). Therefore, this test method is considered applicable to self-consolidating concrete having coarse aggregate up to 1 in (25 mm) in size.

### 6. Apparatus

- 6.1 **Mold** – The mold used in this test method shall conform to that described in FOP for AASHTO T 119.
- 6.2 **Base Plate** – The base plate on which the mold rests shall be nonabsorbent, smooth, rigid, and have a minimum diameter of 36 in (915 mm).

**Note 1:** Field experience and results from the round robin test program have shown that base plates made from sealed/laminated plywood, acrylic plastic, or steel are suitable for performing this test.

- 6.3 **Strike-off Bar** – As described in FOP for WAQTC T 152.

### 7. Sample

- 7.1 The sample of concrete from which test specimens are made shall be representative of the entire batch. Sample in accordance with FOP for WAQTC TM 2.

## 8. Procedure

- 8.1 The slump-flow test shall be performed on a flat, level, nonabsorbent base plate. Position and shim the base plate so it is fully supported, flat, and level.
- 8.2 Filling the Mold – WSDOT requires the use of Procedure B.
- 8.2.1 Filling Procedure B (Inverted Mold) – Dampen and place the mold, with the smaller opening of the mold facing down, in the center of a flat, moistened base plate or concrete surface. Using a suitable container, fill the entire mold continuously (Note 2). The mold shall be held firmly in place during filling. Do not rod or tamp the SCC. Slightly overfill the mold.
- Note 2:** Filling the mold with concrete by using multiple scoops or by pouring from a bucket or similar container has been found to be acceptable.
- 8.3 Strike off the surface of the concrete level with the top of the mold by a sawing motion of the strike-off bar. Remove concrete from the area surrounding the base of the mold to preclude interference with the movement of the flowing concrete. Remove the mold from the concrete by raising it vertically. Raise the mold a distance of  $9 \pm 3$  in ( $225 \pm 75$  mm) in  $3 \pm 1$  seconds by a steady upward lift with no lateral or torsional motion. Complete the entire test from start of the filling through removal of the mold without interruption within an elapsed time of  $2\frac{1}{2}$  minutes.
- 8.4 Wait for the concrete to stop flowing and then measure the largest diameter of the resulting circular spread of concrete to the nearest  $\frac{1}{4}$  in (5 mm). When a halo is observed in the resulting circular spread of concrete, it shall be included as part of the diameter of the concrete. Measure a second diameter of the circular spread at an angle approximately perpendicular to the original measured diameter.
- 8.5 If the measurement of the two diameters differs by more than 2 in (50 mm), the test is invalid and shall be repeated.

## 9. Calculation

- 9.1 Calculate the slump flow using Eq 1:

$$\text{Slump flow} = \frac{(d^1 + d^2)}{2}$$

where:

- $d^1$  = the largest diameter of the circular spread of the concrete, and  
 $d^2$  = the circular spread of the concrete at an angle approximately perpendicular to  $d^1$

- 9.2 Record the average of the two diameters to the nearest  $\frac{1}{4}$  in (5 mm).

## 10. Report

- 10.1 Report the slump flow to the nearest  $\frac{1}{4}$  in (5 mm).
- 10.2 Report results on concrete delivery ticket (i.e., Certificate of Compliance).
- 10.3 The name of the tester who performed the field acceptance test is required on concrete delivery tickets containing test results.

## 11. Precision and Bias

See ASTM C1611/C 1611M for precision and bias.



# Performance Exam Checklist

## WSDOT FOP for ASTM C 1611/C 1611M

### Standard Test Method for Slump Flow of Self-Consolidating Concrete

Participant Name: \_\_\_\_\_ Exam Date: \_\_\_\_\_

Record the symbols "P" for passing or "F" for failing on each step of the checklist.

Procedure Element	Trial 1	Trial 2
1. The tester has a copy of the current procedure on hand?	_____	_____
2. All equipment is functioning according to the test procedure, and if required, has the current calibration/verification tags present?	_____	_____
3. Sample was taken per WSDOT FOP for WAQTC TM 2?	_____	_____
4. Molds and base plate dampened and base plate is flat, level, and fully supported?	_____	_____
5. Mold filled completely (slightly overfilled)?	_____	_____
6. Mold struck off level with top opening?	_____	_____
7. Excess material removed from base plate and mold raised $9 \pm 3$ inches, in $3 \pm 1$ seconds?	_____	_____
8. After flow stabilized, measured largest diameter (including halo if necessary)?	_____	_____
9. Second measurement taken approximately perpendicular to first measurement?	_____	_____
10.. First and second measurements agree within 2"?	_____	_____
11. Slump flow was reported as an average of the two measurements?	_____	_____
12. Slump flow reported to the nearest $\frac{1}{4}$ "?	_____	_____

Comments: First Attempt: Pass \_\_\_\_\_ Fail \_\_\_\_\_ Second Attempt: Pass \_\_\_\_\_ Fail \_\_\_\_\_

Examiner Signature: \_\_\_\_\_ WAQTC #: \_\_\_\_\_





# WSDOT FOP for ASTM C 1621/C 1621M<sup>1</sup>

## Standard Test Method for Passing Ability of Self-Consolidating Concrete by J-Ring

### 1. Scope

- 1.1 This test method covers determination of the passing ability of self-consolidating concrete by using the J-Ring in combination with a slump cone mold. The test method is limited to concrete with maximum size of aggregate of 1 in (25 mm).
- 1.2 The values stated in either inch-pounds or SI units are to be regarded separately as standard. Within the text, the SI units are shown in brackets. The values stated in each system are not exact equivalents; therefore, each system shall be used independently of the other. Combining values from the two systems may result in nonconformance with the standard.
- 1.3 The text of this standard references notes that provide explanatory material. These notes (excluding those in tables and figures) shall not be considered as requirements of the standard.
- 1.4 This standard does not purport to address all of the safety concerns, if any, associated with its use. It is the responsibility of the user of this standard to establish appropriate safety and health practices and determine the applicability of regulatory limitations prior to use. (**Warning:** Fresh hydraulic cementitious mixtures are caustic and may cause chemical burns to skin and tissue upon prolonged exposure.)

### 2. Referenced Documents

#### 2.1 ASTM Standards

- C 125 Terminology Relating to Concrete and Concrete Aggregates
- C 143/C 143M  
Test Method for Slump of Hydraulic-Cement Concrete
- C 172 Practice for Sampling Freshly Mixed Concrete
- C 173/C 173M  
Test Method for Air Content of Freshly Mixed Concrete by the Volumetric Method
- C 1611/C 1611M  
Test Method for Slump Flow of Self-Consolidating Concrete

---

<sup>1</sup>This Test Method is based on ASTM C 1621/C 1621M and has been modified per WSDOT standards. To view the redline modifications, contact the WSDOT Quality Systems Manager at 360-709-5412.

### 3. Terminology

#### 3.1 Definitions

3.1.1 For definitions of terms used in this test method, refer to Terminology C 125.

#### 3.2 Definitions of terms specific to this standard:

3.2.1 **Halo** – An observed cement paste or mortar ring that has clearly separated from the coarse aggregate, around the outside circumference of concrete after flowing from the slump cone.

3.2.2 **J-ring** – An apparatus consisting of a rigid ring supported on sixteen  $\frac{5}{8}$  in (16 mm) diameter rods equally spaced on a 12 in (300 mm) diameter circle 4 in (100 mm) above a flat surface as shown in [Figure 1](#).

3.2.3 **J-ring flow** – The distance of lateral flow of concrete using the J-Ring in combination with a slump cone.

3.2.4 **Passing ability** – The ability of self-consolidating concrete to flow under its own weight (without vibration) and fill completely all spaces within intricate formwork, containing obstacles, such as reinforcement.

### 4. Summary of Test Method

4.1 A sample of freshly mixed concrete is placed in a slump mold (inverted position) that is concentric with the J-Ring ([Figure 2](#)). The concrete is placed in one lift without tamping or vibration. The mold is raised, and the concrete is allowed to pass through J-Ring and subside ([Figure 3](#)).

The diameters of the concrete, in two directions approximately perpendicular to each other, are measured and averaged to obtain the J-Ring flow. The test is repeated without the J-Ring to obtain the slump flow.

The difference between the slump flow and J-Ring flow is an indicator of the passing ability of the concrete.

## 5. Significance and Use

- 5.1 This test method provides a procedure to determine the passing ability of self-consolidating concrete mixtures. The difference between the slump flow and J-Ring flow is an indication of the passing ability of the concrete. A difference less than 1 in (25 mm) indicates good passing ability and a difference greater than 2 in (50 mm) indicates poor passing ability. The orientation of the slump cone for the J-Ring test and for the slump flow test without the J-Ring shall be the same.

**Figure 1**

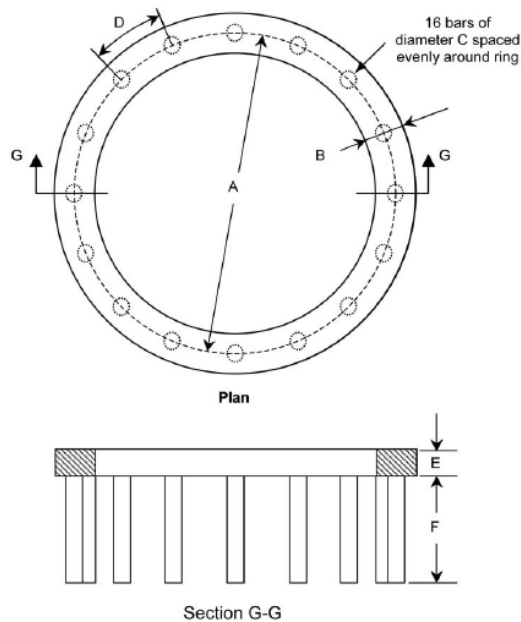

Dimension	in	mm
A	12.0 ± 0.13	300 ± 3.3
B	1.5 ± 0.06	38 ± 1.5
C	0.625 ± 0.13	16 ± 3.3
D	2.36 ± 0.06	58.9 ± 1.5
E	1.0 ± 0.06	25 ± 1.5
F	4.0 ± 0.06	200 ± 1.5

- 5.2 This test method is applicable for laboratory use in comparing the passing ability of different concrete mixtures. It is also applicable in the field as a quality control test.

## 6. Apparatus

- 6.1 J-Ring – The apparatus shall consist of a steel (or equivalent nonabsorbent, rigid material) ring measuring 12 in (300 mm) in diameter at the center of the ring and 1 in (25 mm) in thickness, and sixteen  $\frac{5}{8}$  in (16 mm) diameter smooth steel rods spaced evenly around the ring measuring 4 in (100 mm) in length (see [Figure 1](#)).
- 6.2 Mold – The mold (slump cone) used in this test method is as described in FOP for AASHTO T 119.
- 6.3 Base Plate – A nonabsorbent, rigid plate having a diameter of at least 36 in (915 mm).
- Note 1:** Field experience has shown that base plates made from sealed or laminated plywood, rigid plastic, or steel are suitable for performing this test.
- 6.4 Strike Off Bar – As described in FOP for WAQTC T 152.
- 6.5 Measuring Device – A ruler, metal roll-up measuring tape, or similar rigid or semi-rigid length measuring instrument marked in increments of  $\frac{1}{4}$  in (5 mm) or less.

## 7. Sample

- 7.1 The sample of concrete from which test specimens are made shall be representative of the entire batch. It shall be obtained in accordance with FOP for WAQTC TM 2.

## 8. Procedure

- 8.1 Perform the test on a flat, level, and nonabsorbent base plate. Position and shim the base plate so that it is fully supported and level. Pre-moisten base-plate with a damp towel, rag, or sponge. Rest the J-Ring at the center of the base plate.

**Figure 2 J-Ring Setup with Inverted Mold Filled with Concrete**

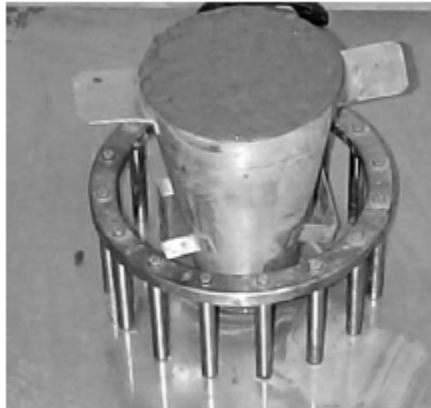

**Figure 3 Ring Flow**



- 8.2 WSDOT uses only Procedure B.

- 8.1.2 Filling Procedure B (Inverted Mold) – Dampen the mold, and place it on the base plate with the smaller opening facing down and concentric with the J-Ring. Support the mold and fill the mold in one lift (Note 2). Heap the concrete above the top of the mold.

**Note 2:** Filling the mold with concrete by using multiple scoops or by pouring from a bucket or similar container has been found to be acceptable.

- 8.3 Strike off the surface of the concrete level with the top of the mold by a sawing motion of the strike off bar. Remove concrete from the area surrounding the mold to preclude interference with the movement of the flowing concrete. Raise the mold a distance of  $9 \pm 3$  in ( $230 \pm 75$  mm) in  $3 \pm 1$  s by a steady vertical lift with no lateral or torsional motion. Complete the entire procedure from start of the filling through removal of the mold without interruption within an elapsed time of 2½ min.
- 8.4 Wait for the concrete to stop flowing and then measure the largest diameter ( $d_1$ ) of the resulting circular flow of concrete. When a halo is observed in the resulting circular flow of concrete, it shall be included as part of the diameter of the concrete. Measure a second diameter ( $d_2$ ) of the circular flow at approximately perpendicular to the first measured diameter ( $d_1$ ). Measure the diameters to the nearest ¼ in (5 mm). Determine the J-Ring flow in accordance with Section 9 of this test method.
- 8.5 Conduct a slump flow test without the J-Ring in accordance with Test Method C 1611/ C 1611M. Use the same filling procedure as used with the J-Ring. Complete the tests with and without the J-Ring within 6 min.

## 9. Calculation

9.1 Calculate J-Ring flow according to the following equation:

$$\text{J-Ring flow} = \frac{d^1 + d^2}{2}$$

9.2 Calculate the slump flow according to the following equation:

$$\text{Slump flow} = \frac{d^1 + d^2}{2}$$

9.3 Calculate the difference between slump flow and J-Ring flow to the nearest ½ in (10 mm). This number represents the passing ability of the concrete.

## 10. Blocking Assessment

10.1 Identify blocking assessment according to [Table 1](#).

**Table 1** Blocking Assessment

Difference Between Slump Flow and J-Ring Flow	Blocking Assessment
0 to 1 in (0 to 25 mm)	No visible blocking
> 1 to 2 in (>25 to 50 mm)	Minimal to noticeable blocking
> 2 in (>50 mm)	Noticeable to extreme blocking

## 11. Report

11.1 Report the filling procedure (A or B) that was used.

11.2 Report the J-Ring flow as the average of the two measured diameters to the nearest ½ in (10 mm).

11.3 Report the slump flow (without the J-Ring) as the average of the two measured diameters to the nearest ½ in (10 mm).

11.4 Report the passing ability as the difference between the slump flow and J-Ring flow to the nearest ½ in (10 mm). Identify the blocking assessment.

11.5 Report results on concrete delivery ticket (i.e., Certificate of Compliance).

11.6 The name of the tester who performed the field acceptance test is required on concrete delivery tickets containing test results.

## 12. Precision and Bias

See ASTM C 1621/C 1621M for precision and bias.



# Performance Exam Checklist

## WSDOT FOP for ASTM C 1621/C 1621M

### Standard Test Method for Passing Ability of Self-Consolidating Concrete by J-Ring

Participant Name: \_\_\_\_\_ Exam Date: \_\_\_\_\_

Record the symbols "P" for passing or "F" for failing on each step of the checklist.

Procedure Element	Trial 1	Trial 2
1. The tester has a copy of the current procedure on hand?	_____	_____
2. All equipment is functioning according to the test procedure, and if required, has the current calibration/verification tags present?	_____	_____
3. Sample was taken per WSDOT FOP for WAQTC TM 2?	_____	_____
4. Molds and base plate dampened and base plate is flat, level and fully supported?	_____	_____
5. Mold is centered in J-Ring and centered on base plate?	_____	_____
6. Mold filled completely in one lift (slightly overfilled)?	_____	_____
7. Mold struck off level with top opening?	_____	_____
8. Excess material removed from base plate and mold raised $9 \pm 3$ inches, in $3 \pm 1$ seconds?	_____	_____
9. After flow has stabilized, measure largest diameter (including halo)?	_____	_____
10. Second measurement taken approximately perpendicular to first measurement?	_____	_____
11. Measurements made to nearest $\frac{1}{4}$ "?	_____	_____
12. Test performed within 6 minutes of FOP for ASTM C 1611?	_____	_____
13. All calculations performed correctly?	_____	_____
14. Results reported to the nearest $\frac{1}{2}$ "?	_____	_____

Comments: First Attempt: Pass \_\_\_\_\_ Fail \_\_\_\_\_ Second Attempt: Pass \_\_\_\_\_ Fail \_\_\_\_\_

Examiner Signature: \_\_\_\_\_ WAQTC #: \_\_\_\_\_





## Performance Exam Checklist

### ASTM D 2628 AASHTO M220

#### Test for High and Low Temperature Recovery of Elastomeric Joint Seals for Concrete Pavements

Participant Name: \_\_\_\_\_ Exam Date: \_\_\_\_\_

Record the symbols "P" for passing or "F" for failing on each step of the checklist.

Procedure Element	Trial 1	Trial 2
1. Sample is cut into 5-inch pieces?	_____	_____
2. Specimens for high and low temperature recovery tests (2 each) lightly dusted with talc?	_____	_____
3. Specimens deflected between parallel plates to 50% of the nominal width using a compression device clamp assembly?	_____	_____
<b>High Temperature Recovery</b>		
1. Clamp assembly containing the compressed specimens placed in an oven capable of maintaining $212 \pm 2^\circ\text{F}$ ( $100 \pm 1^\circ\text{C}$ ) and kept there for 70 hours?	_____	_____
2. Clamp assembly removed from the oven after 70 hours?	_____	_____
3. Unclamped the assembly and carefully removed the specimens?	_____	_____
4. Specimens allowed to rest on a wooden surface at room temperature for 1 hour?	_____	_____
5. Recovered width of the specimens measured in the center of the 5-inch length at the top of the longitudinal edge using a dial caliper or other measuring device?	_____	_____
6. Data entered into the computer data base where % Recovery is automatically calculated?	_____	_____
<b>Low Temperature Recovery</b>		
1. Clamp assembly containing the compressed specimens placed in a refrigerated chamber capable of maintaining $-20 \pm 2^\circ\text{F}$ ( $-29 \pm 1^\circ\text{C}$ ) and kept there for 22 hours?	_____	_____
2. Clamp assembly removed from the chamber after 22 hours?	_____	_____
3. Unclamped the assembly and carefully removed the specimens?	_____	_____
4. Specimens transferred to a wooden surface in the chamber and allowed to recover for 1 hour?	_____	_____
5. Specimens removed from the chamber and measured the recovered width in the center of the 5-inch length at the top of the longitudinal edge using a dial caliper or other measuring device?	_____	_____
6. Data entered into the computer data base where % Recovery is automatically calculated?	_____	_____

Recovery, % = recovered width  $\times$  100/nominal width

Comments: First Attempt: Pass \_\_\_\_\_ Fail \_\_\_\_\_ Second Attempt: Pass \_\_\_\_\_ Fail \_\_\_\_\_

Examiner Signature: \_\_\_\_\_ WAQTC #: \_\_\_\_\_

## **ASTM D 4354 (Modified)**

### ***Standard Practice for Sampling of Geosynthetics for Testing***

ASTM D 4354 has been adopted by WSDOT with the following changes and/or additions:

Geotextiles tested in the Materials Laboratory will be conditioned in accordance with WSDOT Method T 915 in preparation for testing rather than the conditioning prescribed in the ASTM test procedures. This will be identified on all Geotextile Test Reports.



# WSDOT FOP for ASTM D 6931

## Standard Test Method for Indirect Tensile (IDT) Strength of Asphalt Mixtures

WSDOT has adopted ASTM D 6931 as published at [www.wsdot.wa.gov/tools-services/library-services/access-aashto-publications-and-astm-aci-or-sspc-standards](http://www.wsdot.wa.gov/tools-services/library-services/access-aashto-publications-and-astm-aci-or-sspc-standards) with the following changes:

### 6. Specimens

6.1 Laboratory-Molded Specimens – Prepare the 150 mm (5.9 in) laboratory-molded specimens in accordance with WSDOT FOP for AASHTO T 312, to a height of  $62 \pm 1.0$  mm ( $2.44 \pm 0.04$  in). A minimum of three replicates shall be prepared for each mixture.

6.1.1 Air void (Va) of test specimen shall be  $7.0 \pm 1.0$  %.

### 7. Procedure

7.1 Section 7.1 shall be deleted in its entirety.

### 8. Calculation

8.1 Calculate the IDT strength as follows:

$$S_T = \frac{2F}{3.14 (hd)}$$

Where:

- $S_T$  = Indirect tensile strength (psi)
- F = Total applied vertical load at failure (lbs)
- h = Height of specimen (inches)
- d = Diameter of specimen (inches)



# Tester Qualification Practical Exam Checklist

## Determining Indirect Tensile Strength of Compacted Bituminous Mixtures

### FOP for ASTM D 6931

Participant Name: \_\_\_\_\_ Exam Date: \_\_\_\_\_

Record the symbols "P" for passing or "F" for failing on each step of the checklist.

Procedure Element	Trial 1	Trial 2
1. The tester has a copy of the current procedure on hand?	_____	_____
2. All equipment is functioning according to the test procedure, and if required, has the current calibration/verification tags present?	_____	_____
3. Specimen height is $62 \pm 1.0$ mm ( $2.44 \pm 0.04$ in) or 38.1 mm (1.5 in) minimum for cores?	_____	_____
4. Specimen meets air void tolerance of 7.0 + 1.0 %?	_____	_____
5. Specimen placed in water bath at $77 + 2^{\circ}\text{F}$ ( $25 + 1^{\circ}\text{C}$ ) for a minimum of 30 minutes but not longer than 120 minutes?	_____	_____
6. Press turned on and operating at a deformation rate of 2 in per minute?	_____	_____
7. Specimen placed on lower loading strip?	_____	_____
8. Upper loading strip lowered onto specimen with light contact?	_____	_____
9. Upper and lower loading strips parallel with each other?	_____	_____
10. Load applied at 2 in per minute?	_____	_____
11. Total applied vertical load recorded?	_____	_____
12. Indirect tensile strength in psi calculated and recorded correctly?	_____	_____

Comments: First Attempt: Pass \_\_\_\_\_ Fail \_\_\_\_\_ Second Attempt: Pass \_\_\_\_\_ Fail \_\_\_\_\_

Examiner Signature: \_\_\_\_\_ WAQTC #: \_\_\_\_\_

## Tester Qualification Practical Exam Checklist

### FOP for ASTM D 6931

#### *Determining Indirect Tensile Strength of Compacted Bituminous Mixtures*

Participant Name: \_\_\_\_\_ Exam Date: \_\_\_\_\_

Record the symbols "P" for passing or "F" for failing on each step of the checklist.

Procedure Element	Trial 1	Trial 2
1. The tester has a copy of the current procedure on hand?	_____	_____
2. All equipment is functioning according to the test procedure, and if required, has the current calibration/verification tags present?	_____	_____
3. Specimen height is $62 \pm 1.0$ mm ( $2.44 \pm 0.04$ in) or 38.1 mm (1.5 in) minimum for cores?	_____	_____
4. Specimen meets air void tolerance of $7.0 + 1.0$ %?	_____	_____
5. Specimen placed in water bath at $77 + 2^\circ\text{F}$ ( $25 + 1^\circ\text{C}$ ) for a minimum of 30 minutes but not longer than 120 minutes?	_____	_____
6. Press turned on and operating at a deformation rate of 2 in per minute?	_____	_____
7. Specimen placed on lower loading strip?	_____	_____
8. Upper loading strip lowered onto specimen with light contact?	_____	_____
9. Upper and lower loading strips parallel with each other?	_____	_____
10. Load applied at 2 in per minute?	_____	_____
11. Total applied vertical load recorded?	_____	_____
12. Indirect tensile strength in psi calculated and recorded correctly?	_____	_____

Comments: First Attempt: Pass \_\_\_\_\_ Fail \_\_\_\_\_ Second Attempt: Pass \_\_\_\_\_ Fail \_\_\_\_\_

Examiner Signature: \_\_\_\_\_ WAQTC #: \_\_\_\_\_





## **WSDOT FOP for ASTM D 7012**

### ***Standard Test Method for Unconfined Compressive Strength of Intact Rock Core Specimens***

ASTM D 7012 has been adopted by WSDOT with the following changes and/or additions:

The standard preparation of specimens for the above test will be as described below.

#### **4. Test Specimens**

- 4.1 Specimen arrives cut to length, ready for testing
- 4.2 Specimens are measured for length to the nearest 0.01 in (0.25 mm) at the centers of the faces.
- 4.3 Specimens are measured for diameter to the nearest 0.01 in (0.25 mm) by averaging two diameters measured at right angles to each other at about mid height of the specimen.
- 4.4 The specimen ends are checked that they are at right angles to the longitudinal axis. The ends are recut if greater than 5 degrees different from a right angle.
- 4.5 The specimen shall have a length to diameter ratio of 2.0 to 2.5 and the diameter shall be greater than 1 $\frac{7}{8}$  inch (48 mm).



## Performance Exam Checklist

### *Nondestructive Measurement of Thickness of Nonmagnetic Coatings on a Ferrous Base*

#### *FOP for ASTM D 7091/SSPC Procedure 2 (Field)*

Participant Name \_\_\_\_\_ Exam Date \_\_\_\_\_

<b>Procedure Element</b>	<b>Yes</b>	<b>No</b>
1. The tester has a copy of the current procedure on hand?		
2. All equipment is functioning according to the test procedure, and if required, has the current calibration/verification tags present?		
3. Instrument calibrated in accordance with the manufacturer's instructions before use employing a suitable thickness standard?		
4. Several readings taken and recorded taking into account edge and curvature effects?		
5. (Laboratory) The average thickness converted to oz. ft <sup>2</sup> (g/m <sup>2</sup> ) using appropriate conversion factor?		
6. (Field) Average thickness reported in mils?		

First Attempt: Pass      Fail                      Second Attempt: Pass      Fail

Signature of Examiner \_\_\_\_\_

Comments:



## Performance Exam Checklist

### FOP for ASTM D 7091/SSPC Procedure 2 (Field)

#### *Nondestructive Measurement of Thickness of Nonmagnetic Coatings on a Ferrous Base*

Participant Name: \_\_\_\_\_ Exam Date: \_\_\_\_\_

Record the symbols "P" for passing or "F" for failing on each step of the checklist.

Procedure Element	Trial 1	Trial 2
1. The tester has a copy of the current procedure on hand?	_____	_____
2. All equipment is functioning according to the test procedure, and if required, has the current calibration/verification tags present?	_____	_____
3. Instrument calibrated in accordance with the manufacturer's instructions before use employing a suitable thickness standard?	_____	_____
4. Several readings taken and recorded taking into account edge and curvature effects?	_____	_____
5. (Laboratory) The average thickness converted to oz. ft <sup>2</sup> (g/m <sup>2</sup> ) using appropriate conversion factor?	_____	_____
6. (Field) Average thickness reported in mils?	_____	_____

Comments: First Attempt: Pass \_\_\_\_\_ Fail \_\_\_\_\_ Second Attempt: Pass \_\_\_\_\_ Fail \_\_\_\_\_

Examiner Signature: \_\_\_\_\_ WAQTC #: \_\_\_\_\_

