

# ESA 4d Regional Road Maintenance Program Guidelines BMPs

## Contents

BMP Aqua Barrier .....	5
BMP Back of Slope Planting .....	8
Cofferdam .....	10
Coir Fabric .....	13
Coir Log .....	15
Concrete Containment (1) .....	18
Concrete Containment (2) .....	21
Construction Access Road.....	23
Continuous Berm .....	26
Curb Inlet Sediment Trap.....	29
Dewatering.....	34
Diaper Netting.....	36
Ditch Lining .....	38
Diversion Berm.....	40
Diversion Channel .....	42
Dust Control .....	45
Excelsior Filled Log .....	47
Filter Fabric .....	49
Grass Lined Channel.....	51
Gravel Filled Sump .....	55
Half Round Filter .....	56
Hand Seeding .....	58
Hydroseeding .....	60
Inlet Protection .....	62
Kimble Filter Pipe .....	69
Large Woody Debris.....	71
Mulching .....	79
Plastic Covering.....	81
Plywood Work Platform.....	83
Rip Rap .....	85
Rock Check Dam.....	87

Sandbag.....	90
Sediment Sump.....	94
Silt Mat.....	98
Siltation Pond.....	100
Soil Stabilization.....	103
Straw Bale Barrier 1.....	108
Straw Bale Barrier 2.....	112
Straw Bale Barrier 3.....	117
Straw Log.....	120
Stream Bank Stabilization - Bioengineering.....	123
Stream Bypass.....	124
Streambed Gravel.....	128
Surface Roughening.....	130
Sweeping.....	134
Temporary Sediment Trap.....	136
Triangular Silt Dike.....	139
Turbidity Curtain.....	143
Vactoring.....	147
Vegetative Buffer.....	149
Washed Rock.....	151
Absorbent Pads.....	152
Bridge Containment System.....	154
Bucket Tram.....	156
Carbon Dioxide for Cement Leachate.....	158
Divers.....	161
Drain Cover.....	163
Fiber Rolls.....	165
Flushing.....	168
Gravel Washing.....	170
Hand Work.....	172
HEPA Filter Vacuum.....	174
Material and Equipment Use Over Water.....	176
Pocket Pond.....	178
Pull Dozer.....	180
Pump Intake Screen.....	184

Pump Intake Screen and Pump Outlet Energy Dissipater.....	185
Secondary Containment Pumps.....	188
Silt Fence Sediment Basin .....	189
Skip Ditching.....	191
Soil Compaction .....	193
Sump .....	195
Supersacks.....	196
Suspender Cable Cleaning and Painting .....	200
Terrestrial & Non-Marine Species Guide .....	204
Culvert Plug.....	207
Filter Sock Energy Dissipater.....	209
Water-filled Tubular Bladder .....	210
Wood Strand Erosion Control Mulch .....	212
Spring Berm.....	214
Water Barrier .....	215







## **BMP AQUA BARRIER**

---

### **DESCRIPTION**

An aqua barrier is a manufactured vinyl tube filled with water to provide a temporary/portable dam or barrier positioned to contain or divert the movement of water.

### **PURPOSE**

The purpose of this BMP includes, but is not limited to:

- Providing a dry construction area in a stream or waterway.
- Providing a bypass for a stream or waterway.
- Temporary reservoirs for water storage.
- Excluding waters from work area under and around bridges or piers.

### **APPLICATIONS**

This BMP may be used for stream diversion at a construction site. It may be used in fish habitat restoration, flood control, erosion control through diversion or containment of flowing water, silt containment, sedimentation collection or settling ponds, and/or as a portable dam.

### **LIMITATIONS**

This BMP should not be used:

- To cross more than 2/3 of the main flow of any salmonid bearing water at the time of the year when any life history stage of salmonids are expected to be present. (unless required by permit)
- Other than specified by the manufacturer's guidelines.

### **CONSTRUCTION GUIDELINES**

- When used in watercourses or streams, aqua barriers must be used in accordance with permit requirements.
  - Refer to Appendix B for Fish Exclusion Protocols.
  - Follow manufacturer recommendations and guidelines for installation and safety measures.
  - Knives shall be worn by workers for emergency deflation.
  - Keep a repair kit on site in case of small punctures.
-



- Remove any visible rocks or sharp objects prior to installing barrier.
- The aqua barrier can be deployed on dry ground, in standing and/or flowing water.
- Multiple aqua barriers can be joined with connections.

*Aqua barrier used as  
coffer dam*

### **BMP MAINTENANCE**

- Inspect BMPs several times daily during the workweek. Schedule additional inspections during storm events. Any required repairs shall be made.
- Repair punctures with repair kit immediately.
- Allow to dry before rolling up for storage.
- Store away from chemicals, and above 10° F.

### **BMP REMOVAL**

- Follow manufacturer recommendations for removal.
- Remove BMP (recycle and/or reuse if applicable).
- Water discharged from water barrier shall meet water quality temperature standards at the point of discharge.



*Installing aqua barrier in river to provide a dry construction area*



## **BMP BACK OF SLOPE PLANTING**



---

### **DESCRIPTION**

Back of slope planting requires leaving the roadway slope clear for public safety. This BMP includes planting grass, forbs, small trees and brush. This BMP provides long term soil stabilization and/or reduces water velocity/erosive forces.

### **PURPOSE**

The purpose of this BMP includes, but is not limited to:

- Ditch slopes vegetated with grass and forbs to reduce exposed soil.
- Planting trees and brush outside of the ditch on the back of the slope allowing plants to grow over the ditch or channel.
- Providing shade as long as it does not become a public safety hazard (No trees larger than 4-inches allowed in clear zone or recovery area).

### **APPLICATIONS**

This BMP may be used in ditches (including ditches which are watercourses or streams) parallel to roadways or at road crossings. Revegetation plans will be done in accordance with permit requirements and federal highway safety design or standards. It may be used in combination with other BMPs.

This BMP provides long term soil stabilization once plantings have been established. Soil stabilization can only be achieved in combination with other BMPs. For example; Grasses and forbs on shoulder and in ditch slopes with brush, shrubs or trees behind the ditch.

### **LIMITATIONS**

This BMP should not be used:

- If it creates a potential public safety hazard.
- In clear zone areas.
- If it could cause water flow problems that may result in flooding of the roadway..

### **CONSTRUCTION GUIDELINES**

- Select appropriate native vegetation for the location.
-



- Review planting guidelines; plant at the appropriate time of year.
- Planting must be done in accordance with design and/or permit conditions.

### **BMP MAINTENANCE**

- Inspect during plant establishment period. Replant, due to plant mortality, as necessary.

### **BMP REMOVAL**

- BMP removal is not necessary.

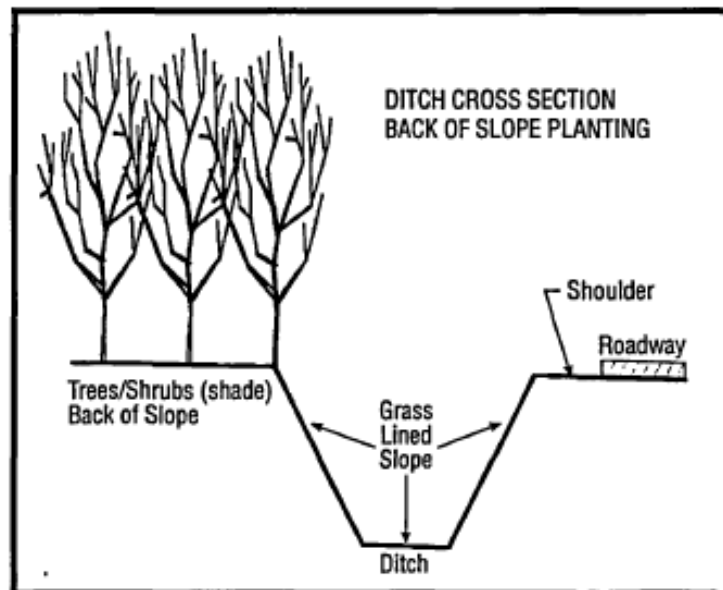

# Cofferdam

## **BMP COFFERDAM**



---

### **DESCRIPTION**

A cofferdam is a temporary structure built into a waterway to enclose a construction area and reduce sediment pollution from construction work in and under water. Cofferdams can be made of steel, rock, sand bags, wood or aqua barriers.

### **PURPOSE**

The purpose of this BMP includes, but is not limited to:

- Dewatering construction areas.

### **APPLICATIONS**

This BMP may be used in construction activities such as culvert installation, bridges, piers, or abutments. It may be used in combination with other barriers and is commonly used in conjunction with stream bypass and/or pumps.

### **LIMITATIONS**

This BMP should not be used:

- In deep water unless designed or reviewed by an engineer.

### **CONSTRUCTION GUIDELINES**

- When used in watercourses or streams, cofferdams must be used in accordance with permit requirements.
- Refer to Appendix B for Fish Exclusion Protocols.
- Construction guidelines depend on cofferdam material selection. See pictures for construction details.

### **BMP MAINTENANCE**

- During construction, inspect BMPs daily during the workweek. Schedule additional inspections during storm events. Make any required repairs.
- Repair gaps, holes or scour.



### **BMP REMOVAL**

- Evaluate site to determine BMP is no longer needed (the area has stabilized—potential of sediment laden water exiting the area has passed).
- Remove sediment buildup in front of BMP.
- Remove BMP (recycle and/or re-use if applicable).
- Re-vegetate area disturbed by BMP removal (if applicable).



*Sandbags used as a cofferdam*



## SANDBAG COFFER DAM DETAIL

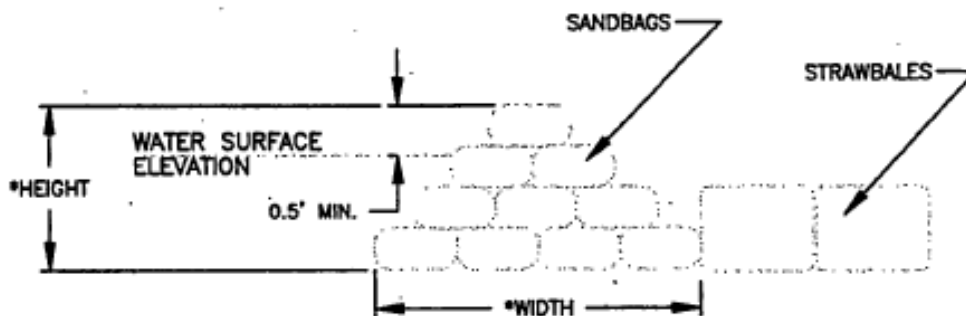

\* HEIGHT AND WIDTH OF COFFER DAM SHALL BE DETERMINED BY THE WATER SURFACE ELEVATION AT THE TIME OF CONSTRUCTION.

### NOTES:

1. SANDBAGS SHALL BE USED IN ACCORDANCE WITH APPLICABLE PERMITS.
2. INSTALL COFFER DAM AND DEWATER SITE PRIOR TO CONSTRUCTION
3. PROVIDE ADEQUATE FREEBOARD.

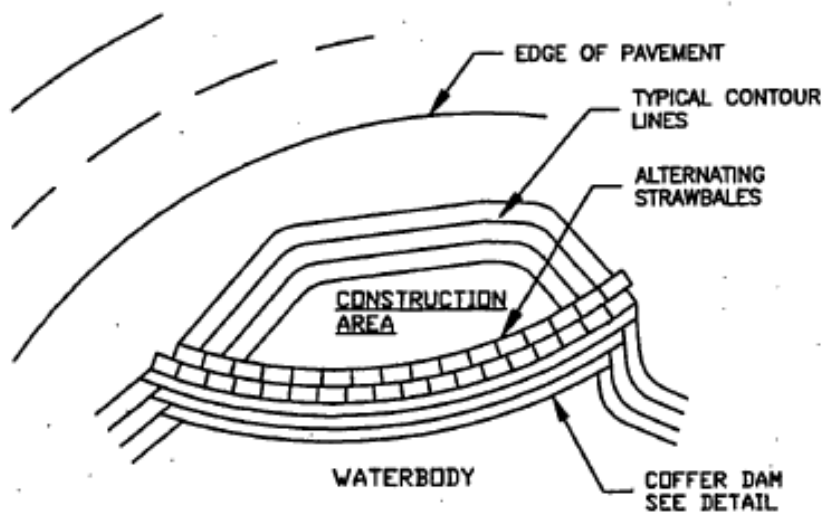





## **BMP COIR FABRIC**

---

### **DESCRIPTION**

Coir Fabric is a geo-textile product made from coconut fibers loosely woven into a fabric usually packaged in roll form. This fabric can be used to provide a reduction in water velocity/erosive forces and/or habitat protection/maintenance.

### **PURPOSE**

The purpose of this BMP includes, but is not limited to:

- Decreasing bank erosion in high flow/high velocity channels.
- Long term slope stabilization.
- Stream and riverbank stabilization.
- Revegetation projects.

### **APPLICATIONS**

This BMP may be used in areas to provide stabilization/protection to the soil surface of steep slopes, stream and/or river banks. It can be used in combination with vegetation to reinforce soil in high flow/high velocity waters and on slopes as steep as 1 horizontal to 1 vertical. It may be used as bank stabilization before vegetation/re-vegetation has occurred.

### **LIMITATIONS**

This BMP should not be used:

- In the streambed of a channel.
- When short term biodegradability is required.

### **CONSTRUCTION GUIDELINES**

- When used in water courses or streams, this BMP must be used in accordance with permit requirements.
  - The fabric may be laid out horizontally or vertically on a slope.
  - Use stakes or staples to anchor fabric to ground. Use anchoring devices on the edges and in the field of the fabric.
  - Lay loosely on the surface so fabric makes contact with the ground. (Don't stretch the fabric.)
-



- If the seam is perpendicular with water flow, overlap fabric at least 18-inches in the direction of water flow.
- If the seam is parallel with the water flow, overlap edges at least 8-inches, staking both edges securely.
- The fabric should be trenched at least 12" deep at top and bottom ends of the installation to prevent undercutting of the fabric.
- Hand Seeding and/or Hydroseeding should occur prior to coir fabric placement.
- Live staking may be done after coir fabric placement by piercing fabric.

### **BMP MAINTENANCE**

- During construction, inspect BMPs daily during the work week. Schedule additional inspections during storm events. Make any required repairs.

### **BMP REMOVAL**

- BMP removal is not necessary.



*Coir fabric*

---



## **BMP COIR LOG**

---

### **DESCRIPTION**

A coir log is a manufactured coconut fiber log used as a structural and rooting mechanism for bioengineered systems. These logs can be used to provide filter/perimeter protection, settling, reduction in water velocity/erosive forces and habitat protection/maintenance. They may be cut or folded, to the appropriate length, to fit the desired location.

### **PURPOSE**

The purpose of this BMP includes, but is not limited to:

- Intercepting sheet flow.
- Intercepting and detaining small amounts of water from disturbed areas during construction operations in order to promote settling of soil particles.
- Filtering soil particles, and debris.
- Trapping topsoil and retaining moisture from rainfall, which aids in growth of seedlings planted along the upslope side of the rolls.

### **APPLICATIONS**

This BMP may be used for temporary check dams in ditches of any dimension, temporary soil stockpile protection, drop inlet protection, temporary interceptor dike and swale, check dam in ditches and/or bank stabilization. Coir logs may also be used for habitat protection at the toe of a bank and can be incorporated with vegetative planting. This BMP may be used for perimeter sediment control. This BMP is particularly useful in areas where the effects of soil disturbance need to be minimized. It may be used in combination with other BMPs.

### **LIMITATIONS**

This BMP should not be used:

- Where flow volume or velocity inhibit BMP function.
- When maintenance activities conducted in locations could reduce actual or potential high flow salmonid refuge functions, this BMP will be used if required by permit conditions.



---

## **CONSTRUCTION GUIDELINES**

- Coir log installation must be done in accordance with applicable design and/or permit conditions.
- Install to prevent water from going around or under BMP.
- BMP must be staked (wood only) to insure soil particle containment.
- When using as a check dam, prior to installation, cut or fold to proper length.

## **BMP MAINTENANCE**

- During construction, inspect BMPs daily during the workweek. Schedule additional inspections during storm events. Make any required repairs.
- Sediment should be removed when deposits reach one-half the height of the BMP.

## **BMP REMOVAL**

- Evaluate site to determine BMP is no longer needed (the area has stabilized—potential of sediment laden water exiting the area has passed).
- Remove sediment buildup in front of BMP.
- Removal of BMP may not always be necessary.
- Depending upon BMP placement, re-vegetation of site may be necessary.



*Coir logs used as habitat protection at the toe of a bank*



*Coir log used to allow settling and to decrease water velocity/erosive forces*

---

## Concrete Containment (1)

### **BMP CONCRETE CONTAINMENT (1)**



---

#### **DESCRIPTION**

**C**oncrete containment is the method(s) of containing uncured concrete that is pumped or poured into forms while repairing structures in or around watercourses.

#### **PURPOSE**

The purpose of this BMP includes, but is not limited to:

- Reducing uncured concrete and chemicals from leaving the work site and entering the adjacent body of water.

#### **APPLICATIONS**

This BMP may be used when dewatering is not possible for bridge repair work. Concrete containment devices may include fiberglass/steel column forms, a "Sea-form" bag system and/or steel plates to line work area. It may be used in combination with other BMPs such as cofferdams, turbidity curtains and/or dewatering/silt ponds.

#### **LIMITATIONS**

- Limitations are site specific.

#### **CONSTRUCTION GUIDELINES**

- When used in watercourses or streams, this BMP must be used in accordance with permit requirements.
  - Concrete containment systems should be designed or reviewed by an engineer.
  - Identify work site.
  - Isolate work area. If possible, dewater construction area.
  - As conditions allow, provide approved secondary containment.
  - Have adequate fuel supply and backup pumps in the event of emergency or mechanical failure.
  - For tool and/or equipment cleanup onsite, a temporary sump may be used to contain water from cleanup.
  - Remove material from sump after cleanup is complete.
-



**BMP MAINTENANCE**

- Inspect structure during construction for leaks.
- Repair any leaks in structure.
- Contain and remove any excess materials, such as chemicals and/or concrete.

**BMP REMOVAL**

- Remove BMP as concrete and permit conditions require; this may be immediately or it may be up to 10 days after the concrete is cured (recycle and/or re-use if applicable).

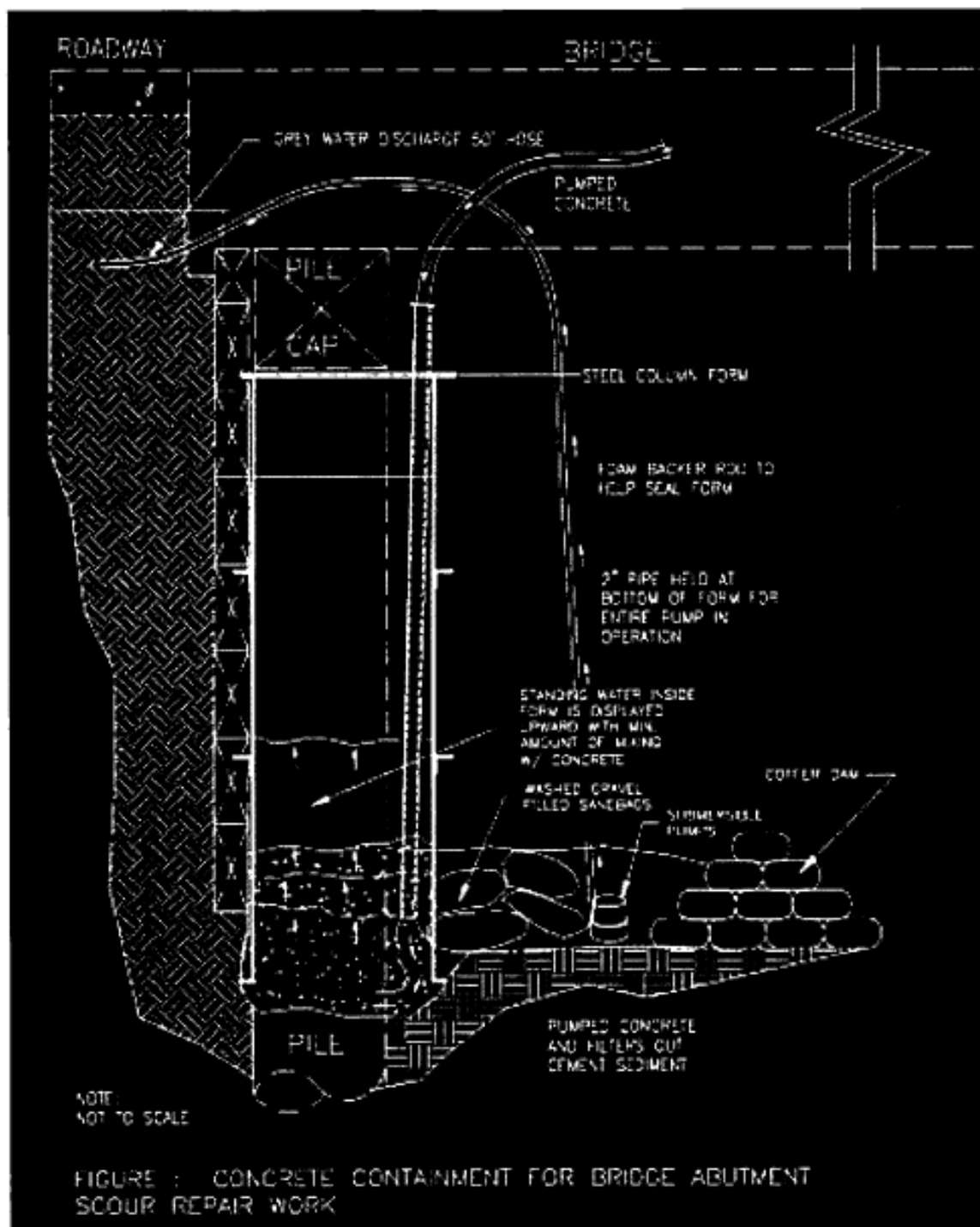





## **BMP CONCRETE CONTAINMENT (2)**

---

### **DESCRIPTION**

**C**oncrete containment is a method of containing uncured concrete pumped or poured into forms while constructing and/or repairing structures, such as sidewalks, curbs, gutters, manholes and catch basins.

### **PURPOSE**

The purpose of this BMP includes, but is not limited to:

- Containing uncured concrete and chemicals from leaving the work site.
- Containing water from exposed aggregate work areas.
- Containing water from equipment cleanup.

### **APPLICATIONS**

This BMP may be used when performing flatwork, curb and gutter or utility concrete repair work. It may be used in combination with other BMPs.

### **LIMITATIONS**

- Limitations are site specific.

### **CONSTRUCTION GUIDELINES**

- When used in watercourses or streams, this BMP must be used in accordance with permit requirements.
- Locate work area.
- Isolate work area.
- Install drain protection downslope, for example, filter fabric, drainage plug and/or use a Vactor truck.
- Cover catch basins adjacent to work area with filter fabric.
- For tool and/or equipment cleanup onsite, a temporary sump may be used to contain water from cleanup.
- Remove material from sump after cleanup is complete.



### **BMP MAINTENANCE**

- Contain and remove any excess materials, such as chemicals and/or concrete.
- Make sure onsite cleanup sump is of adequate size and overflow does not occur.
- Remove sediment buildup as required.

### **BMP REMOVAL**

- Remove waste material.
- Re-vegetate and/or restore area disturbed by BMP.



## **BMP CONSTRUCTION ACCESS ROAD**

---

### **DESCRIPTION**

A construction access road is a stabilized rock (or an alternative material) pad located at points of vehicular ingress and egress at a construction site. The construction access road may include a fabric underliner.

### **PURPOSE**

The purpose of this BMP includes, but is not limited to:

- Allowing stability for vehicle access to construction sites.
- Limiting mud and debris deposited on roadways from adjacent construction sites.

### **APPLICATIONS**

This BMP may be used at construction sites with unstable soils and/or steep slopes to gain traction, especially during wet weather. It may be used in combination with other BMPs.

### **LIMITATIONS**

This BMP should not be used:

- As the sole BMP.

### **CONSTRUCTION GUIDELINES**

- Unsuitable material should be excavated prior to placement of fabric and rock.
- Place an optional "fabric underliner" the full width and length of the access road, as required by design.
- Compact road as appropriate.

### **BMP MAINTENANCE**

- During construction, inspect BMPs daily during the workweek. Schedule additional inspections during storm events. Make any required repairs.
  - Materials spilled, dropped or tracked from vehicles onto roadways should be removed.
  - Water trucks will not be used to remove dropped, spilled, or tracked materials, unless the water can be treated by other BMPs.
-



---

### **BMP REMOVAL**

- Remove BMP if appropriate (recycle and/or re-use if applicable).
- Re-vegetate and/or restore area disturbed by BMP.



*Access road installation*



BMP: CONSTRUCTION ACCESS ROAD (continued)

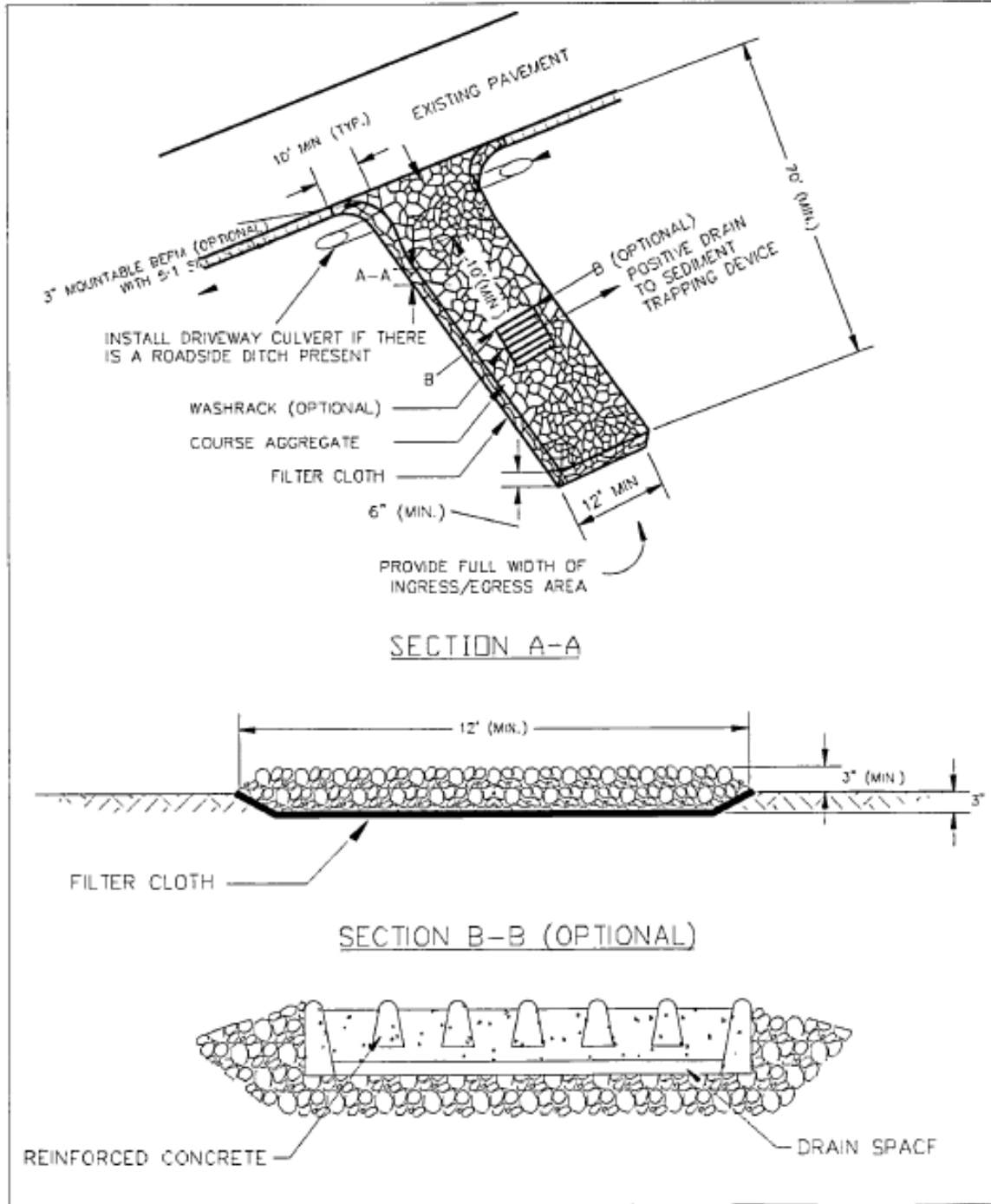

Construction access road detail

# Continuous Berm

## **BMP CONTINUOUS BERM**



---

### **DESCRIPTION**

A continuous berm is a temporary diversion dike or sediment barrier constructed with infill material, either soil, sand or gravel, encased within geosynthetic fabric. This BMP requires a Continuous Berm Machine (CBM) for filling and placing. A continuous berm can be used to provide filter/perimeter protection, settling, and reduction in water velocity/erosive forces.

### **PURPOSE**

The purpose of this BMP includes, but is not limited to:

- Diverting sheet flow.
- Intercepting sheet flow.
- Intercepting and detaining small amounts of water from disturbed areas during construction operations in order to allow settling of soil particles.
- Decreasing down slope sheet flow velocity.
- Retaining soil particles/debris on site.

### **APPLICATIONS**

This BMP may be used for perimeter sediment control. It may be used in combination with other BMPs.

This BMP may be used below disturbed areas subject to sheet and rill erosion where drainage area is no greater than .25 acre per 100 lineal feet of barrier and the slope behind the barrier should be no steeper than 2 horizontal feet to 1 vertical foot. On relatively flat slopes the maximum disturbed slope distance should not exceed 100 feet. The allowable disturbed slope distance decreases as the slope gets steeper.

### **LIMITATIONS**

This BMP should not be used:

- Directly in perennial streams or water courses.
  - In front of storm outlets.
-



### **CONSTRUCTION GUIDELINES**

- Use a Continuous Berm Machine (follow operating manual).
- Apply to relatively smooth surfaces to form a tight seal with ground.
- A source of infill material is required (sand, gravel, or local soils).
- Increase the elevation at the ends of the BMP installation to prevent "end runs."

### **BMP MAINTENANCE**

- During construction, inspect BMPs daily during the workweek. Schedule additional inspections during storm events. Make any required repairs.
- Repair any damaged BMPs due to end runs or undercutting.
- Sediment should be removed when deposits reach one-half the height of the BMP.

### **BMP REMOVAL**

- Evaluate site to determine BMP is no longer needed (the area has stabilized—potential of sediment laden water exiting the area has passed).
- Remove sediment buildup in front of BMP.
- Remove BMP (recycle and/or re-use is applicable).
  - Removal consists of slitting and removing the fabric.
  - Remove the infill material from the site or grade infill material into the existing shoulder or soil.
- Depending upon BMP placement, re-vegetation of site may be necessary.



*Continuous berm*



*Continuous berm machine*



*Continuous berm retaining soil particles and debris*



*Continuous berm intercepting water from construction area*



# Curb Inlet Sediment Trap



## **BMP CURB INLET SEDIMENT TRAP**

---

### **DESCRIPTION**

A curb inlet sediment trap is a temporary barrier constructed from concrete blocks, gravel, filter fabric or gravel bag filter. Geotextile grade covers and geotextile collectors (inserts) are available pre-manufactured. Curb inlet sediment traps can be used to provide filtering and settling of soil particles.

### **PURPOSE**

The purpose of this BMP includes, but is not limited to:

- Reducing the soil particles discharged into storm drains by settling and/or filtering the runoff.
- Allowing for overflow from high runoff events.
- Allowing the ponded water to filter rapidly through gravel.

### **APPLICATIONS**

These BMPs are used at curb inlets on gently sloping streets where water can pond and allow particles to filter or settle.

### **LIMITATIONS**

This BMP should not be used:

- Where the ponding area will encroach into the travel lanes or pedestrian walkways.
- Steep grades.

### **CONSTRUCTION GUIDELINES**

- A spillway structure shall be constructed with the sandbags to allow overflow.
  - Place sandbags in a curved row from the top of curb at least 3 feet into the street; curve the ends upward.
  - Overlap several layers of bags and pack tightly.
  - Leave a one-sandbag gap at the upstream end in the top row to act as a spillway.
  - Slope runoff should flow over blocks and gravel and not be bypassed over the curb.
-



- Install pre-manufactured grade covers and geo-textile collectors in accordance with manufacturer specifications.
- Install grade covers, geo-textile collects, or filter fabric on top of or in front of the inlet. Construct a small dam immediately downstream of the inlet to stop flow.

### **BMP MAINTENANCE**

- Sediment shall be removed.
- If the gravel becomes clogged with sediment, it must be carefully removed from the inlet and either cleaned or replaced.
- During construction, inspect BMPs daily during the workweek. Schedule additional inspections during storm events. Make any required repairs.

### **BMP REMOVAL**

- Evaluate site to determine BMP is no longer needed (the area has stabilized—potential of sediment laden water exiting the area has passed).
- Remove sediment buildup in front of BMP.
- Remove BMP (recycle and/or re-use if applicable).
- Use vacuum sweeper or hand broom to clean road surface.
- Use "Vactor-Truck" to clean drainage system.



*A silt sock installed in a catch basin to trap/filter waterborne soil particles*

---



### BLOCK AND GRAVEL DROP INLET SEDIMENT FILTER

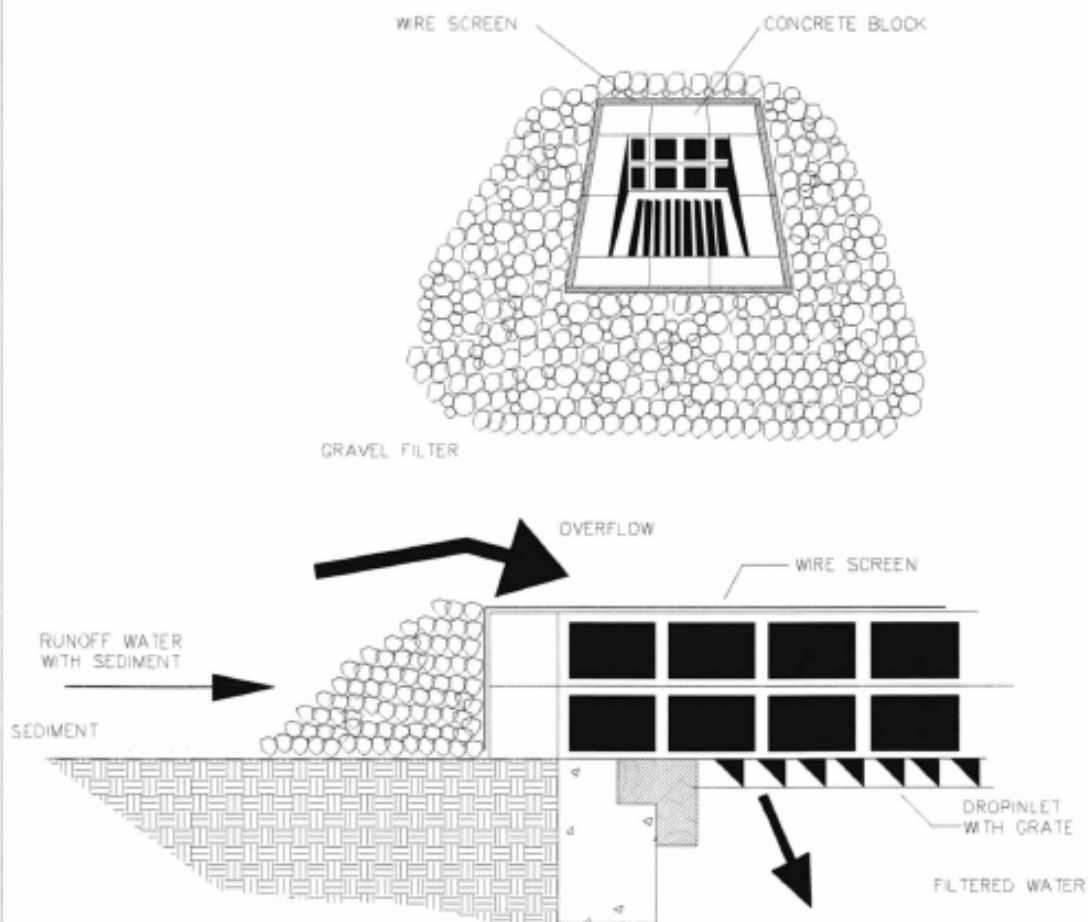

#### SPECIFIC APPLICATION

THIS IS APPLICABLE WHERE HEAVY FLOWS ARE EXPECTED AND WHERE AN OVERFLOW CAPACITY IS NECESSARY TO PREVENT EXCESSIVE PONDING AROUND THE STRUCTURE

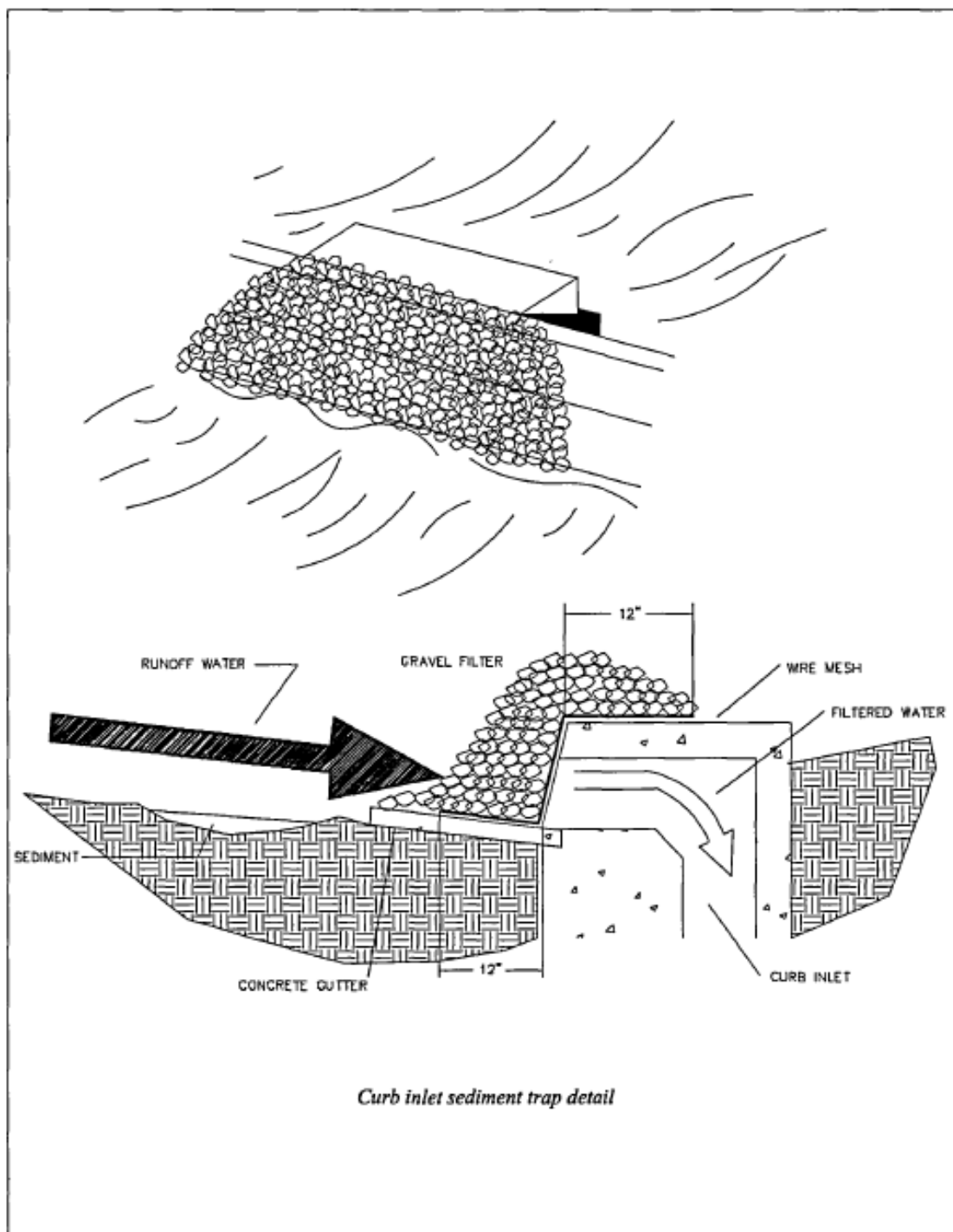



BMP: CURB INLET SEDIMENT TRAP (continued)

*Curb inlet sediment trap detail*

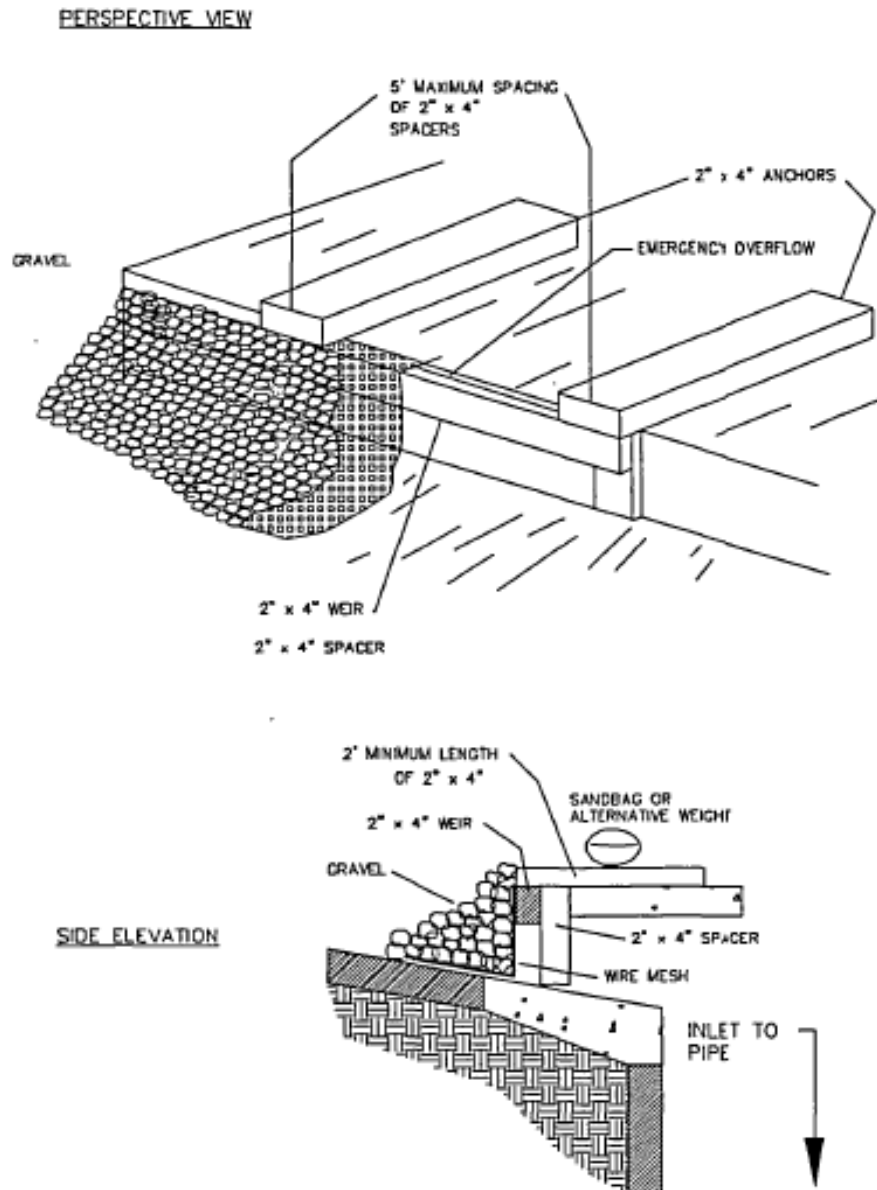

SPECIFIC APPLICATION

THIS IS APPLICABLE TO CURB INLETS WHERE A STURDY, COMPACT INSTALLATION IS DESIRED. EMERGENCY OVERFLOW CAPABILITIES ARE MINIMAL. EXPECT SIGNIFICANT PONDING WITH THIS MEASURE.

## Dewatering

### **BMP DEWATERING**



---

#### **DESCRIPTION**

**D**eewatering can be used to keep water from a work area by using any or all of the following: pump, barrier, vector, or bypass culvert.

#### **PURPOSE**

The purpose of this BMP includes, but is not limited to:

- Allowing work to be performed in dewatered conditions.
- Reducing the transport of soil particles by flowing water.
- Reducing the liquefaction of soils.

#### **APPLICATIONS**

This BMP may be used in, but not limited to, ditches, watercourses or streams, channels, swales and excavations. It will generally be used in combination with other BMPs.

#### **LIMITATIONS**

This BMP should not be used:

- Where flows are greater than pump capacity.

#### **CONSTRUCTION GUIDELINES**

- Determine if the project will require continuous dewatering.
  - Schedule pumping, monitoring, equipment and maintenance activities accordingly.
  - Dewatering must be used in accordance with applicable design and/or permit conditions.
  - Refer to Appendix B for Fish Exclusion Protocols.
  - Install a "Keep Water from Work Area" BMP.
  - Install dewatering devices.
  - Install site specific barrier, prior to dewatering, to prevent exterior water from entering construction area.
  - Ensure water discharged from the site reduces erosion.
  - Dewatered water will be discharged to:
    - A containment device.
-



#### BMP: DEWATERING (continued)

---

- A sanitary sewage system.
- Other BMPs to reduce water borne soil particles prior to the water being reintroduced to a storm drainage system, water course or stream.

#### **BMP MAINTENANCE**

- Schedule pumping, monitoring, equipment and maintenance activities in accordance with dewatering needs.
- During construction, inspect BMPs daily during the workweek. Schedule additional inspections during storm events. Make any required repairs as needed.
- Inspect bypass, pump, and barrier periodically. Make necessary repairs.
- Check for erosion at discharge. Repair or move as necessary.
- Have adequate fuel supply and backup pumps in the event of mechanical failure.

#### **BMP REMOVAL**

- Remove BMP (recycle and/or re-use if applicable).
- Reintroduce water gradually.
- Re-vegetate area disturbed by BMP removal (if applicable).

# Diaper Netting

## **BMP** **DIAPER NETTING**



---

### **DESCRIPTION**

**D**iaper/netting is a fine mesh netting or canvas suspended under a bridge, pipeline or pier to catch debris during construction or maintenance activities.

### **PURPOSE**

The purpose of this BMP includes, but is not limited to:

- Catching and containing falling debris (concrete, wood chips, sawdust, slag and metal) from entering water during construction, maintenance and repair activities.

### **APPLICATIONS**

This BMP is used in bridge, pipeline or pier construction and repairs. It may also be used in maintenance activities such as cleaning and painting. It may be used in combination with other BMPs.

### **LIMITATIONS**

This BMP should not be used:

- During periods of high winds that reduce the effectiveness of the BMP.

### **CONSTRUCTION GUIDELINES**

- Multiple nets with different mesh sizes may be required, depending upon the work tasks performed. Mesh size gets progressively smaller from top to bottom.
- Attach diaper/netting securely prior to starting work.
- Remove diaper/netting carefully after work, not allowing debris to fall.
- Maintain separation between diaper/netting and water surface.

### **BMP MAINTENANCE**

- During construction, inspect BMPs daily during the workweek. Schedule additional inspections during storm events. Make any required repairs.
  - Crew must provide progressive clean up of debris during the day.
-





### **BMP REMOVAL**

- Evaluate site to determine BMP is no longer needed.
- Remove debris on BMP.
- Remove BMP (recycle and/or re-use if applicable).
- Inspect after job is complete to make sure diaper/netting is in good repair for next project.



*Diaper netting under bridge*



*Netting with suspended framework*

---

## **BMP DITCH LINING**



---

### **DESCRIPTION**

**D**itch lining provides a long/short-term erosion resistant lining of the ditch flow line and side slopes utilizing biodegradable or non-biodegradable geo-textile fabrics and/or angular rock to stabilize ditches and channels from erosion and soil particle movement.

### **PURPOSE**

The purpose of this BMP includes, but is not limited to:

- Protecting the soil from erosive forces of concentrated runoff.
- Slowing the velocity of concentrated runoff while enhancing the potential for infiltration and vegetation growth.
- Stabilizing slopes adjacent to ditches which have seepage problems and/or non-cohesive soils.

### **APPLICATIONS**

This BMP may be used in ditches, channels, swales and banks or slopes. It may be used in conjunction with other BMPs.

### **CONSTRUCTION GUIDELINES**

- When used in watercourses or streams, this BMP must be used in accordance with permit requirements.
- Plan for site specific uses.
- Use design specifications when available.
- Channels should be constructed with a wide and shallow cross section.
- Use of angular rock in applications where turbulent water is present.

### **BMP MAINTENANCE**

- During the initial establishment, inspection should occur and any necessary repair made.
  - Grass seed should be applied in accordance with manufacturer specifications.
  - After implementation, the channel should be inspected periodically to determine if channel is withstanding flow velocities without damage.
-



BMP: DITCH LINING (continued)

---

- Check the channel for debris, scour, or erosion and make necessary repairs.
- Remove all significant sediment accumulations to maintain the desired flow line and capacity during maintenance activity.
- Check channel slopes, outlets and all road crossings for bank stability and evidence of erosion, during maintenance activity, and make repairs as necessary.

**BMP REMOVAL**

- Evaluate site to determine BMP is no longer needed (the area has stabilized—potential of sediment laden water exiting the area has passed).
- Remove BMP (recycle and/or re-use if applicable).
- BMP removal is not always necessary.

## Diversion Berm

### **BMP DIVERSION BERM**



---

#### **DESCRIPTION**

A diversion berm is a temporary ridge of compacted soil constructed at the top or base of a disturbed slope.

#### **PURPOSE**

The purpose of this BMP includes, but is not limited to:

- Diverting storm runoff from upslope drainage areas away from unprotected disturbed areas and toward a stabilized outlet.
- Diverting sediment-laden runoff from a disturbed area to a sediment-containment facility such as a sediment trap or a sediment basin.

#### **APPLICATIONS**

This BMP may be used wherever stormwater runoff must be temporarily diverted away from a disturbed slope and toward a sediment containment facility. These structures generally have a life expectancy of 18 months or less. This BMP may be used in combination with other BMPs.

#### **LIMITATIONS**

This BMP should not be used:

- If water flow is likely to erode the berm.
- If there is inadequate space for construction.

#### **CONSTRUCTION GUIDELINES**

- Berms should be installed as a first step in the land-disturbing activity.
- The berm should be adequately compacted to prevent failure.
- Minimum freeboard can be 0.3 feet.
- Temporary seeding and mulch can be applied to the berm following construction of the berm.
- Clear plastic may be used as an additional erosion control method. See "Plastic Covering" BMP construction guidelines.

#### **BMP MAINTENANCE**

- During construction, inspect BMPs daily during the workweek.
-



## BMP: DIVERSION BERM (continued)

Schedule additional inspections during storm events. Make any required repairs.

- During long term implementation inspect once every two weeks, whether a storm has occurred or not.

### BMP REMOVAL

- Evaluate site to determine BMP is no longer needed (the area has stabilized—potential of sediment laden water exiting the area has passed).
- Remove sediment buildup.
- Remove BMP (recycle and/or re-use if applicable).
- Re-vegetate area disturbed by BMP removal (if applicable).

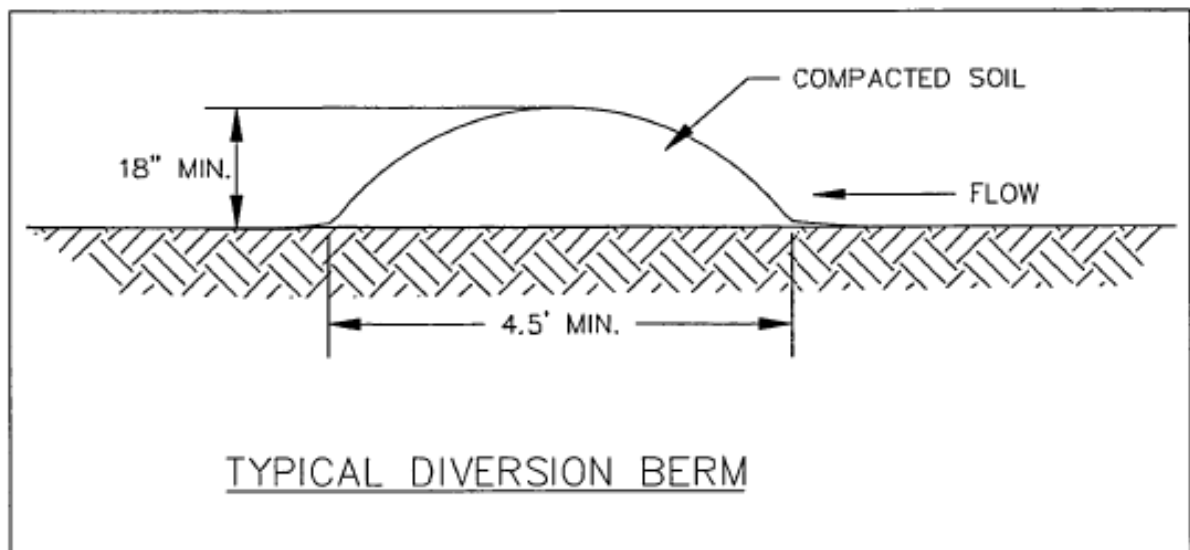

*Diversion berm detail*

## Diversion Channel

### **BMP DIVERSION CHANNEL**



---

#### **DESCRIPTION**

A diversion channel is constructed across a slope with a supporting earthen ridge on the lower side.

#### **PURPOSE**

The purpose of this BMP includes, but is not limited to:

- Reducing slope length.
- Intercepting and diverting stormwater runoff to stabilized outlets at non-erosive velocities.
- Intercepting sheet flow.
- Decreasing down slope sheet flow velocity.

#### **APPLICATIONS**

This BMP may be used where runoff from areas of higher elevation may damage property, cause erosion, or interfere with the establishment of vegetation on downslope areas. It may also be used where surface and/or shallow subsurface flow is damaging a slope and where the slope length needs to be reduced to minimize soil loss. This BMP may be used in combination with other BMPs.

#### **LIMITATIONS**

This BMP should not be used:

- If the downslope is greater than 2 horizontal by 1 vertical.
- If water flow is likely to erode the channel.
- If there is inadequate space for construction.

#### **CONSTRUCTION GUIDELINES**

- The diversion channel shall be excavated or shaped to line, grade and cross-section as required:
    - Side slopes of the channel shall be no steeper than 2 horizontal by 1 vertical.
    - Minimum freeboard shall be 0.3 feet.
  - Compact fill material as needed to prevent unequal settlement.
-



- Temporary seeding and mulch can be applied to the channel following construction of the channel.
- Clear plastic may be used as an additional erosion control method. See "Plastic Covering" BMP construction guidelines.

#### **BMP MAINTENANCE**

- During construction, inspect BMPs daily during the workweek. Schedule additional inspections during storm events. Make any required repairs.
- Seeded areas which fail to establish a vegetative cover shall be reseeded as necessary.
- During long term implementation inspect once every two weeks, whether a storm has occurred or not.

#### **BMP REMOVAL**

- Evaluate site to determine BMP is no longer needed (the area has stabilized—potential of sediment laden water exiting the area has passed).
- Remove sediment buildup.
- Remove BMP (recycle and/or re-use if applicable).
- Re-vegetate area disturbed by BMP removal (if applicable).

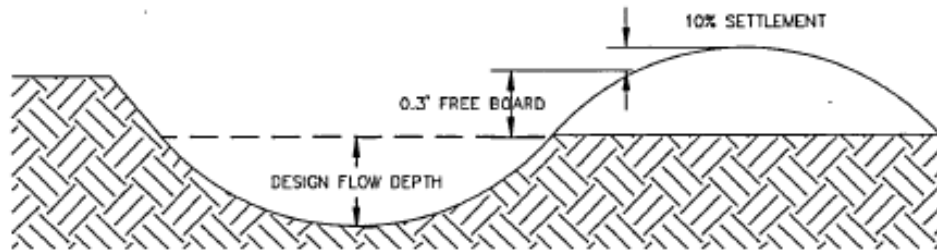

TYPICAL PARABOLIC DIVERSION

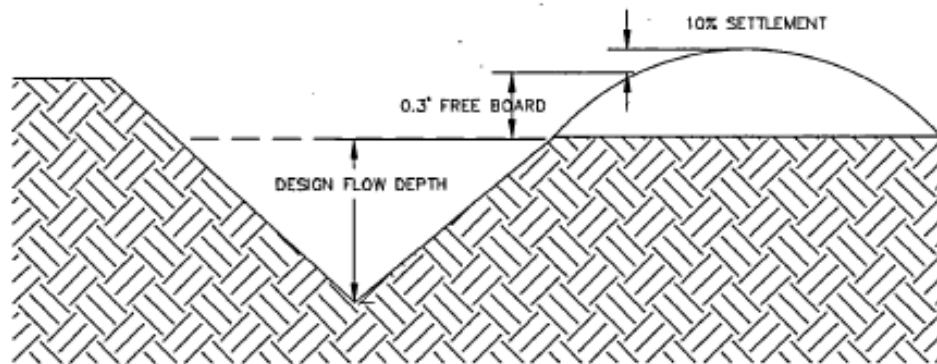

TYPICAL V-SHAPED DIVERSION

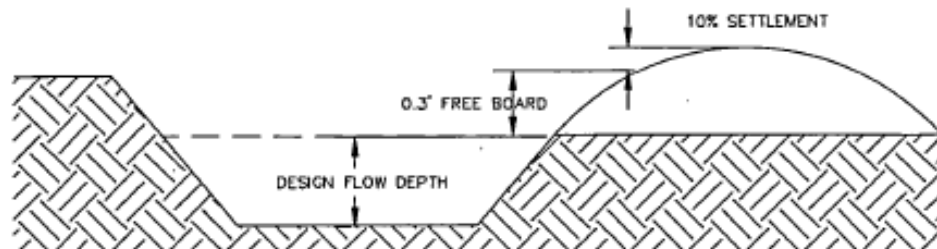

TYPICAL TRAPEZOIDAL DIVERSION





## **BMP DUST CONTROL**

---

### **DESCRIPTION**

**D**ust control is the use of water, products, and/or measures for reducing wind erosion. Particles moved by wind may cause air pollution, soil loss and/or water quality degradation.

### **PURPOSE**

The purpose of this BMP includes, but is not limited to:

- Reducing soil particle travel by wind due to construction or maintenance operation activities.
- Reducing air and water pollution.

### **APPLICATIONS**

This BMP may be used on construction sites, roads, shoulders, operating headquarters or pit/quarry sites. It may be used in combination with other BMPs. Protecting the soil surface is accomplished through measures such as roughening the soil to reduce the surface wind velocity, applying straw/mulch, water, matting, hydroseeding, plastic covering, Lignum derivative, or Magnesium Chloride.

### **LIMITATIONS**

This BMP should not be used:

- With straw in locations where compaction is required (for example, roadway shoulders or road bases).
- If a chemical suppressant could enter watercourses or streams.

### **CONSTRUCTION GUIDELINES**

- Water, Lignum derivative, or Magnesium Chloride can be applied by mechanical means.
  - A temporary straw covering may be applied by hand to a small area of exposed soil where compaction is not required.
  - Surface roughening may be accomplished by using a machine.
  - Create a berm downslope to control possible runoff from watering.
-



### **BMP MAINTENANCE**

- During the construction period, inspect BMPs daily during the workweek. Make any required repairs.
- Reapply BMP as needed.

### **BMP REMOVAL**

- Evaluate site to determine BMP is no longer needed (the area has stabilized—potential of wind erosion has passed).
- Straw removal may be necessary if the area is to be re-vegetated.
- Re-vegetate area disturbed by BMP removal.



*Water wagon wetting down field for dust control*



*Wetting down stockpiles to reduce airborne soil particles*



## **BMP** **EXCELSIOR FILLED LOG**

---

### **DESCRIPTION**

An excelsior filled log is a manufactured log filled with curled wood excelsior. When cut or folded to appropriate length, these logs can be used to provide filter/perimeter protection, settling, reduction in water velocity/erosive forces and habitat protection/maintenance.

### **PURPOSE**

The purpose of this BMP includes, but is not limited to:

- Reducing slope length to capture and retain sediment on the slope.
- Temporarily stabilizing slopes by reducing soil creep, sheet and rill erosion until permanent vegetation can be established.
- Trapping topsoil and retaining moisture from rainfall, which aids in growth of seedlings planted along the upslope side of the rolls.
- Intercepting and detaining small amounts of water from disturbed areas during construction operations in order to promote settling of soil particles.
- Filtering soil particles and debris.
- Reducing water velocity and erosive forces.

### **APPLICATIONS**

This BMP may be used in ditches or across culvert ends of any dimension. Excelsior filled logs may also be used for habitat protection at the toe of a bank and can be incorporated with vegetative planting. It may be used instead of straw logs, coir logs, or straw bale filtering systems. Excelsior filled logs may also be used for perimeter sediment control.

This BMP may be used in gullies and stream channels as check dams in conjunction with gabions, rip rap, articulated block, or cellular confinement systems. It may be used to anchor and enhance the effectiveness of willow wattles (fascines), turf reinforcement mats, coir mats, continuous berms and other erosion control material. Excelsior filled logs may be used to replace silt fences or straw bales on steep slopes. It may be used in combination with other BMPs.



---

## LIMITATIONS

This BMP should not be used:

- Where flow volume or velocity inhibit BMP function.
- For long term applications.
- When maintenance activities conducted in locations could reduce actual or potential high flow salmonid refuge functions, this BMP will be used if required by permit conditions.

## CONSTRUCTION GUIDELINES

- Excelsior filled log must be placed in accordance with applicable design and/or permit conditions.
- Logs are placed and staked along the contour of newly constructed or disturbed slopes, in 2-3 inch deep trench.
- Spacing depends on soil type and slope steepness.
- Tightly abut any adjacent logs.
- Install to prevent water from going around or under BMP.
- See "Live Staking", "Handseeding" and/or "Hydroseeding" BMP for planting.

## BMP MAINTENANCE

- During construction, inspect BMPs daily during the workweek. Schedule additional inspections during storm events. Make any required repairs.
- Sediment should be removed when deposits reach one-half the height of the BMP.

## BMP REMOVAL

- Evaluate site to determine BMP is no longer needed (the area has stabilized—potential of sediment laden water exiting the area has passed).
  - Remove sediment buildup in front of BMP.
  - Depending upon BMP placement, re-vegetation of site may be necessary.
  - BMP removal may not be necessary.
-



## **BMP FILTER FABRIC**

---

### **DESCRIPTION**

**F**ilter fabric is a permeable material made with synthetic fibers. It may be a woven or non-woven fabric and is usually packaged in roll form. This fabric can be used to reduce potential for soil becoming water borne, filter/perimeter protection and/or settling.

### **PURPOSE**

The purpose of this BMP includes, but is not limited to:

- Filtering soil particles from water.
- Stabilizing and reinforcing soils.

### **APPLICATIONS**

This BMP may be used in drainage filtration, to reinforce paved and unpaved roads, stabilize access or haul roads and to separate soils.

### **LIMITATIONS**

This BMP should not be used:

- In the streambed of a channel.
- When short term biodegradability is required.

### **CONSTRUCTION GUIDELINES**

- When used near watercourses or streams, this BMP must be used in accordance with permit requirements.
- Some applications may be designed or reviewed by an engineer.
  - Woven filter fabric should only be used for soil separation, road reinforcement and soil separation.
  - Non-woven filter fabric should only be used for drainage filtration although it may be used under unpaved roads in certain circumstances.
  - Use according to manufacturers details.

### **BMP MAINTENANCE**

- During construction, inspect BMPs daily during the workweek.
-



BMP: FILTER FABRIC (continued)

---

Schedule additional inspections during storm events. Make any required repairs.

#### **BMP REMOVAL**

- Evaluate site to determine BMP is no longer needed (the area has stabilized—potential of sediment laden water exiting the area has passed).
- If used as a filter, remove sediment buildup from in front of the BMP.
- Re-vegetate area disturbed by BMP removal (if applicable).
- BMP removal may not be necessary when it is part of the final structure.



## **BMP GRASS LINED CHANNEL**

---

### **DESCRIPTION**

**A** grass lined channel is the vegetative lining of a ditch, watercourse, stream, or swale to protect it from erosion and to provide filter/perimeter protection.

### **PURPOSE**

The purpose of this BMP includes, but is not limited:

- Reducing erosion by providing ground cover, binding soil particles with roots, and lowering water velocity.
- Providing filter/perimeter protection.
- Providing habitat for primary production.
- Providing habitat for prey base organisms such as macro-invertebrates.

### **APPLICATIONS**

This BMP may be used where a vegetative lining can provide sufficient stability for the channel grade by decreasing velocity; where site conditions require establishment of vegetation (climate, soil and topography are present). This BMP may be used in combination with other bank stabilizing methods.

### **LIMITATIONS**

This BMP should not be used:

- When maintenance activities are conducted in locations which could reduce actual or potential high flow salmonid refuge functions.
- In locations where there is frequent turbulence with flows likely to rip out grass lining, creating erosion and downstream plugging of system.

### **CONSTRUCTION GUIDELINES**

- This BMP must be used in accordance with applicable permit requirements.



### **BMP MAINTENANCE**

- During initial vegetation establishment, inspection should occur and any necessary repairs made.
- After vegetation establishment, the channel should be inspected periodically to determine if the channel is withstanding flow velocities without damage.
- Check the channel for debris, scour, or erosion and make repairs.
- Remove all significant sediment accumulations to maintain the designed carrying capacity. Debris such as litter, car parts, appliances and items that pose a risk to public safety should be removed. Any LWD that falls into the channel and does not pose a threat to public safety or structure damage should be left in place.
- Check channel outlet and all road crossings for bank stability, evidence of piping or scour holes and make repairs.

### **BMP REMOVAL**

- BMP removal is not necessary.



*Grass lined channel: reducing erosion by providing ground cover*



*Grass lined channel: providing a filter*





BMP: GRASS LINED CHANNEL (continued)

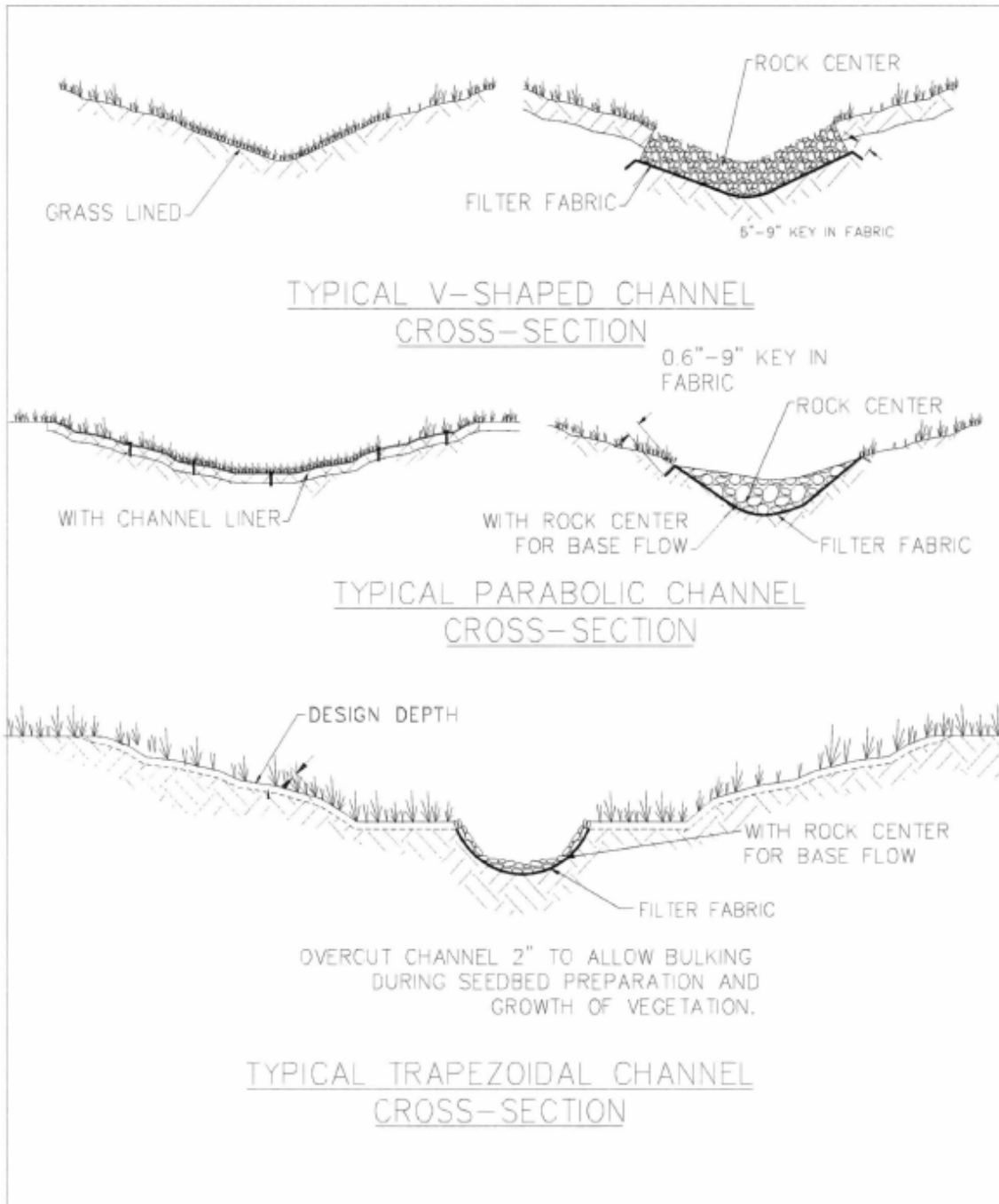



BMP: GRASS LINED CHANNEL (continued)

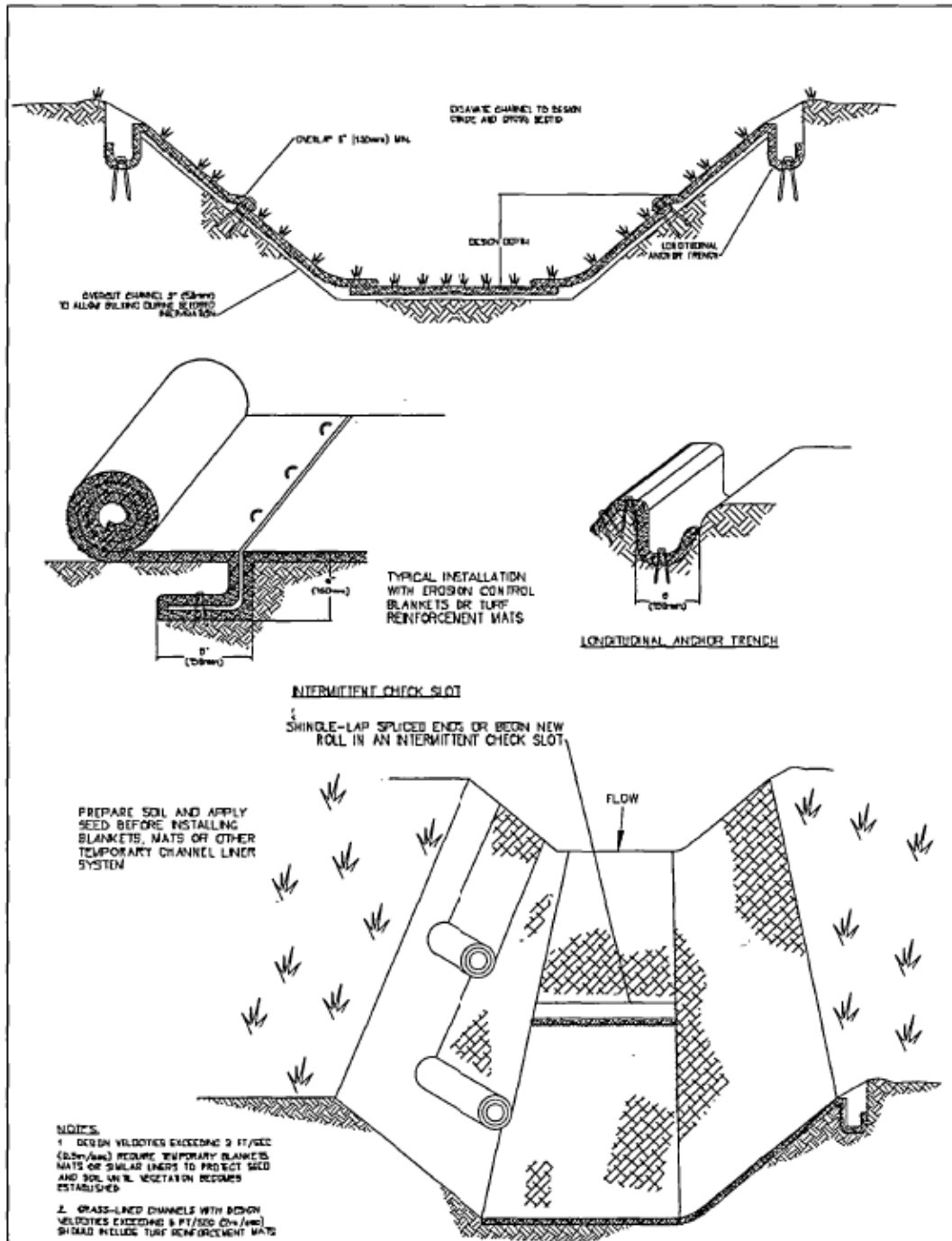



### **BMP GRAVEL FILLED SUMP**

---

#### **DESCRIPTION**

A gravel filled sump is a constructed sump filled with gravel and a standing perforated pipe or bucket that allows pumping filtered water out of a non-erosive location.

#### **PURPOSE**

The purpose of this BMP includes, but is not limited to:

- Dewatering construction sites.
- Filtering sediment from water.

#### **APPLICATIONS**

This BMP is used in conjunction with flow bypass.

#### **LIMITATIONS**

This BMP should not be used:

- When peak flows exceed the pump capacity.

#### **CONSTRUCTION GUIDELINES**

- Excavate hole at least 3 feet deep.
- Line the base and sides of the hole with filter fabric.
- Place perforated pipe inside the hole.
- Shore up pipe by adding washed rock to space between hole and pipe exterior.
- Have adequate fuel supply and backup pumps in the event of mechanical failure.

#### **BMP MAINTENANCE**

- Inspect bypass, pump, and sump periodically. Repair any leaks immediately.
- Check for scour at bypass outfall. Repair or move as necessary.
- Provide downstream sediment filtration.

#### **BMP REMOVAL**

- Remove BMP when in water work is complete.
  - Remove BMP (recycle and/or re-use if applicable).
  - Re-vegetate area disturbed by BMP removal (if applicable).
-

## Half Round Filter

### **BMP HALF ROUND FILTER**



---

#### **DESCRIPTION**

The half round filter BMP is one-half section of perforated pipe cut lengthwise (with optional filter fabric lining) and filled with washed rock.

#### **PURPOSE**

The purpose of this BMP includes, but is not limited to:

- Filtering sediment from water.
- Reducing water velocity.

#### **APPLICATIONS**

This BMP may be used at construction sites to filter sediment-laden water pumped from construction area. This BMP may be used with other sediment control BMPs.

#### **LIMITATIONS**

This BMP should not be used:

- In fast flowing water.
- To filter water with a high percentage of fines.
- As the sole BMP.

#### **CONSTRUCTION GUIDELINES**

- Make sure pump head (if used) is secured within washed rock.
- Make sure length of pipe and amount of rock is sufficient for site.
- Have additional washed rock available on site.
- Have adequate fuel supply and backup pumps in the event of mechanical failure.

#### **BMP MAINTENANCE**

- Evaluate half round filter and pump (if used) periodically to ensure BMP is functioning properly.
  - Check for scour at outfall.
  - Check outlet to make sure water is running clear. If not, add washed rock.
-



### **BMP REMOVAL**

- Evaluate site to determine BMP is no longer needed (the area has stabilized—potential of sediment laden water exiting the area has passed).
- Remove sediment buildup.
- Remove BMP (recycle and/or re-use if applicable).
- Re-vegetate area disturbed by BMP removal (if applicable).

## **BMP HAND SEEDING**



---

### **DESCRIPTION**

**H**and seeding is broadcasting grass seed on disturbed areas by hand or a hand seeding device. This BMP is used to reduce potential for soil becoming water or air borne, to reduce water velocity/erosive forces after vegetation establishment and to aid in habitat protection/maintenance.

### **PURPOSE**

The purpose of this BMP includes, but is not limited to:

- Establishing vegetation in sparse, bare and/or exposed soil areas.
- Decreasing soil erosion.

### **APPLICATIONS**

This BMP may be used after soil disturbance is completed at construction sites. This BMP may be used in areas that need to be permanently or temporarily vegetated. It may be used in conjunction with other BMPs.

### **LIMITATIONS**

This BMP should not be used:

- In months when seed germination will not occur. (In winter months, see "Mulching" and/or "Plastic Covering" BMPs).

### **CONSTRUCTION GUIDELINES**

- Seed mixes vary. Seed selection should be based on the intended use of the area it is applied to, for example, low growing grass versus ditch bank grass.
- Spread seed uniformly and according to manufacturers recommendations.
- Cover with other methods as needed to protect surface (for example, light application of mulch, jute matting).

### **BMP MAINTENANCE**

- Inspect during seed establishment period. Re-seed, due to mortality, as necessary.
  - Schedule additional inspections during storm events and/or heavy
-



**BMP: HAND SEEDING (continued)**

---

rainfall. Check for scour and sloughing; any required repairs shall be made.

**BMP REMOVAL**

- BMP removal is not necessary.

# Hydroseeding

## **BMP** **HYDROSEEDING**



---

### **DESCRIPTION**

**H**ydroseeding is broadcasting grass seed, tackifier, wood fiber mulch and water on disturbed areas by using a hydroseeding machine. This BMP is used to reduce potential for soil becoming water or air borne, to reduce water velocity/erosive forces after vegetation establishment and to aid in habitat protection/maintenance.

### **PURPOSE**

The purpose of this BMP includes, but is not limited to:

- Establishing vegetation in sparse, bare and/or exposed soil areas over a large site.
- Decreasing soil erosion.

### **APPLICATIONS**

This BMP may be used after soil disturbance is completed at construction sites. This BMP may be used in areas that need to be permanently or temporarily vegetated. It may be used in conjunction with other BMPs.

### **LIMITATIONS**

This BMP should not be used:

- In months when seed germination will not occur. (In winter months, see "Mulching" and/or "Plastic Covering" BMPs).
- During strong winds or freezing weather.

### **CONSTRUCTION GUIDELINES**

- Seed mixes vary. Seed selection should be based on the intended use of the area it is applied to. i.e. low growing grass versus ditch bank grass.
- Spread seed uniformly and according to manufacturer's recommendations.
- Cover hydroseeded area with other methods as needed.
- Hydroseeding should be applied after finish grading and/or surface roughening. Application may depend on slope, soil, exposure and time of year.
- Tackifier and/or moisture retention agent may need to be added, per state standard.





### **BMP MAINTENANCE**

- Inspect during seed establishment period. Re-seed, due to mortality, as necessary.
- Schedule additional inspections during storm events and/or heavy rainfall. Check for scour and sloughing; any required repairs shall be made.

### **BMP REMOVAL**

- BMP removal is not necessary.



*Erosion protection and vegetation establishment after maintenance work*

## Inlet Protection

### **BMP** **INLET PROTECTION**



---

#### **DESCRIPTION**

**I**nlet protection is a sediment filter located at the inlet to a storm drainage conveyance. It may be an external structure such as a filter fence box or a gravel berm. Inlet protection may also be an internal device such as a silt sock or a silt trap.

#### **PURPOSE**

The purpose of this BMP includes, but is not limited to:

- Reducing soil particles from entering storm drainage systems.

#### **APPLICATIONS**

This BMP may be used in ditches at the inlet to enclosed drainage systems. They may also be used in manholes or catch basins. This BMP may be used in combination with other BMPs.

#### **LIMITATIONS**

This BMP should not be used:

- Where there are traffic conflicts.
- In areas where it creates excessive ponding.
- To remove excessive fines.

#### **CONSTRUCTION GUIDELINES**

- Refer to sketches on following pages for details and specific construction guidelines.

#### **BMP MAINTENANCE**

- During construction, inspect BMPs daily during the workweek. Schedule additional inspections during storm events. Make any required repairs.
- Sediment should be removed when deposits reach one-half the height of the BMP.



### **BMP REMOVAL**

- Evaluate site to determine BMP is no longer needed (the area has stabilized—potential of sediment laden water exiting the area has passed).
- Remove sediment buildup in front of BMP.
- Remove BMP (recycle and/or re-use if applicable).
- Re-vegetate area disturbed by BMP removal (if applicable).



*Inlet protection: filter fence surrounding catch basin to reduce soil particles from entering drainage system*

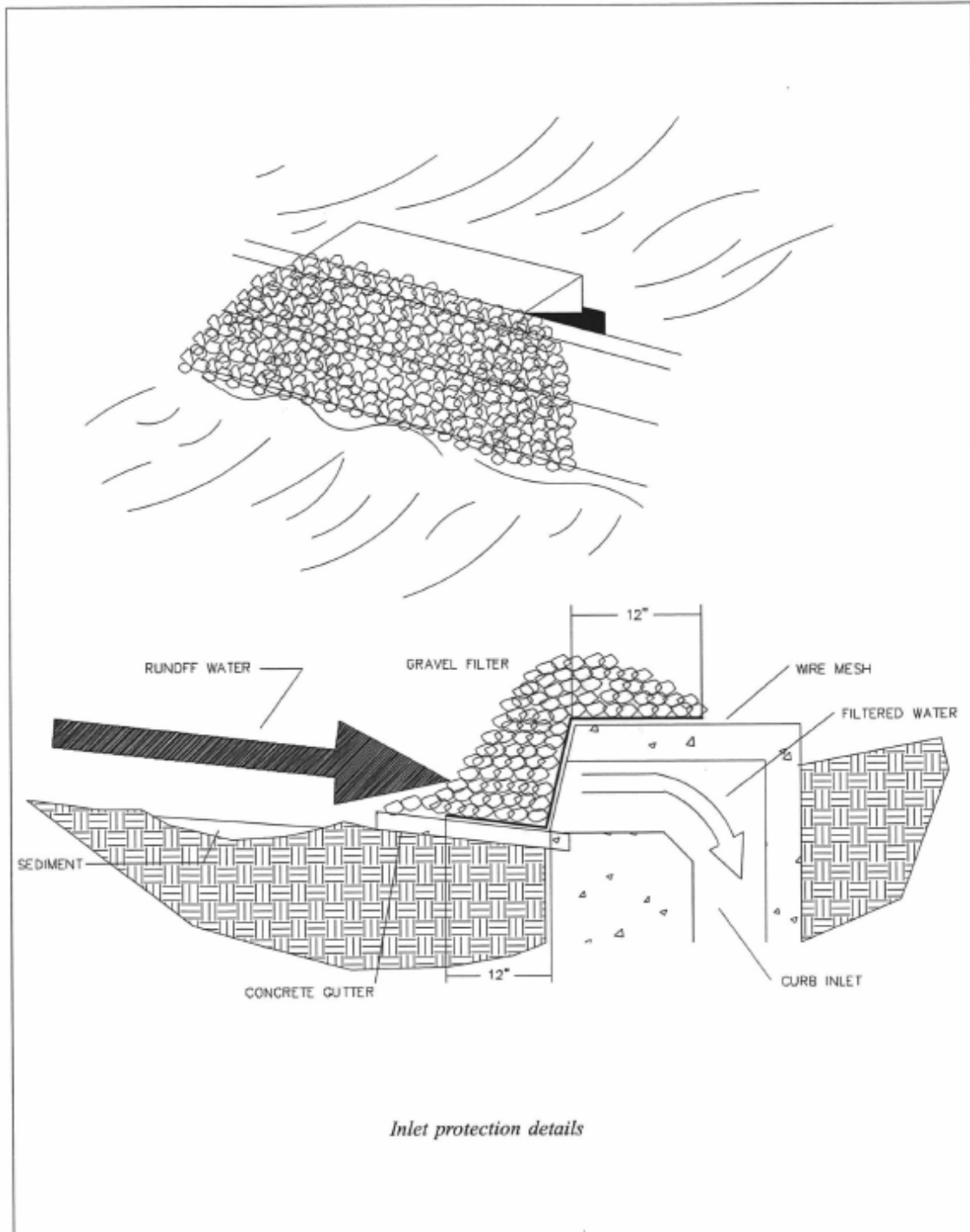



## SILT FENCE DROP INLET PROTECTION

### PERSPECTIVE VIEWS

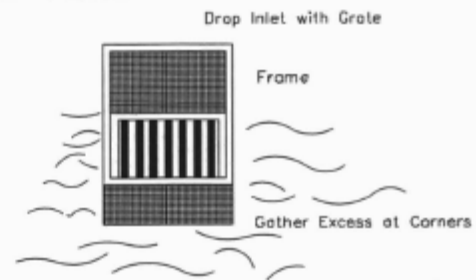
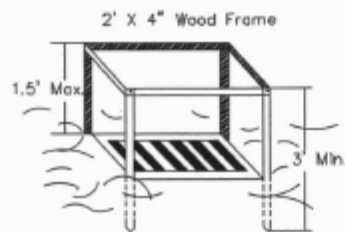

### ELEVATION OF STAKE AND FABRIC ORIENTATION

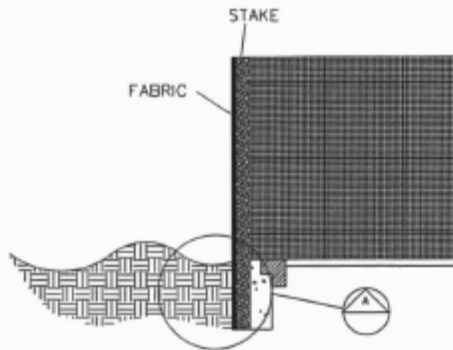

### DETAIL A

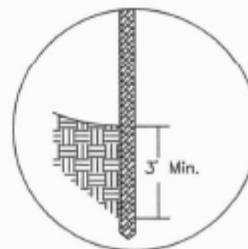

### SPECIFIC APPLICATION

THIS METHOD OF INLET PROTECTION IS APPLICABLE WHERE THE INLET DRAIN IS A RELATIVELY FLAT AREA (SLOPE CANNOT EXCEED 5%). WHERE INLET SHEET OR OVERLAND FLOWS ARE TYPICAL AND CANNOT EXCEEDING 1 CFS. THIS METHOD SHALL NOT BE USED WHERE THE INLETS ARE RECEIVING CONCENTRATED FLOWS, SUCH AS IN STREETS OR HIGHWAY MEDIANS



### BLOCK AND GRAVEL DROP INLET SEDIMENT FILTER

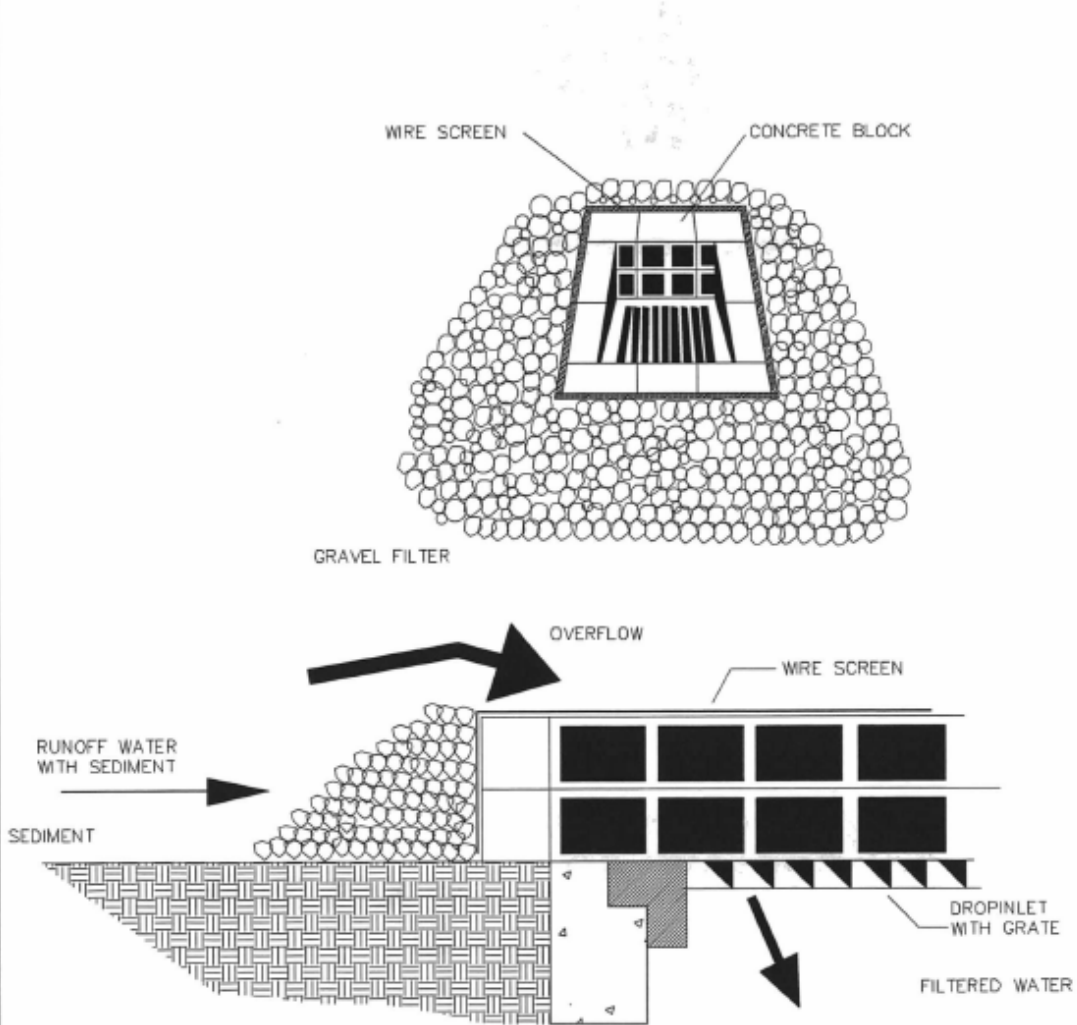

SPECIFIC APPLICATION

THIS IS APPLICABLE WHERE HEAVY FLOWS ARE EXPECTED AND WHERE AN OVERFLOW CAPACITY IS NECESSARY TO PREVENT EXCESSIVE PONDING AROUND THE STRUCTURE



BMP: INLET PROTECTION (continued)

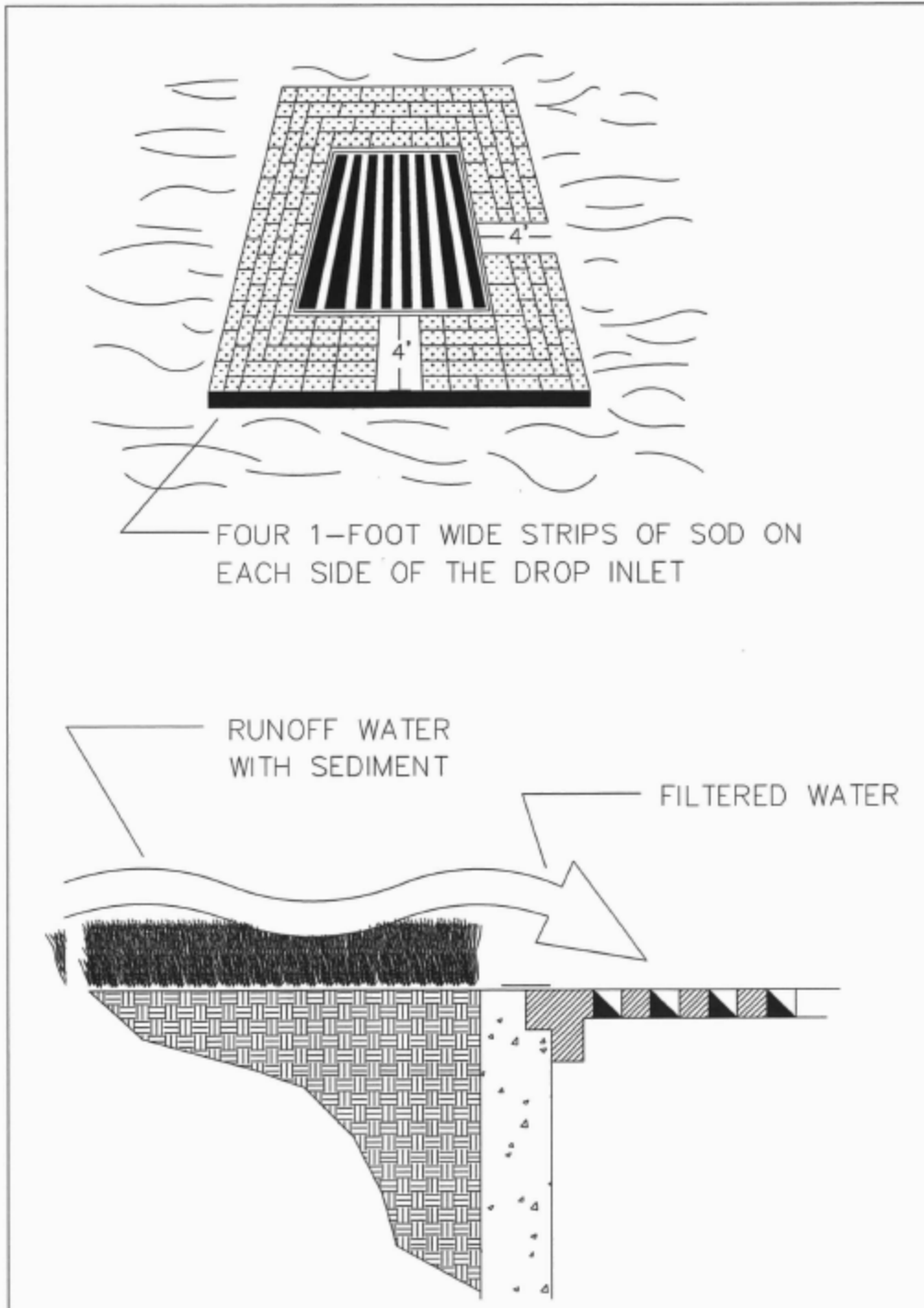

*Inlet protection detail*

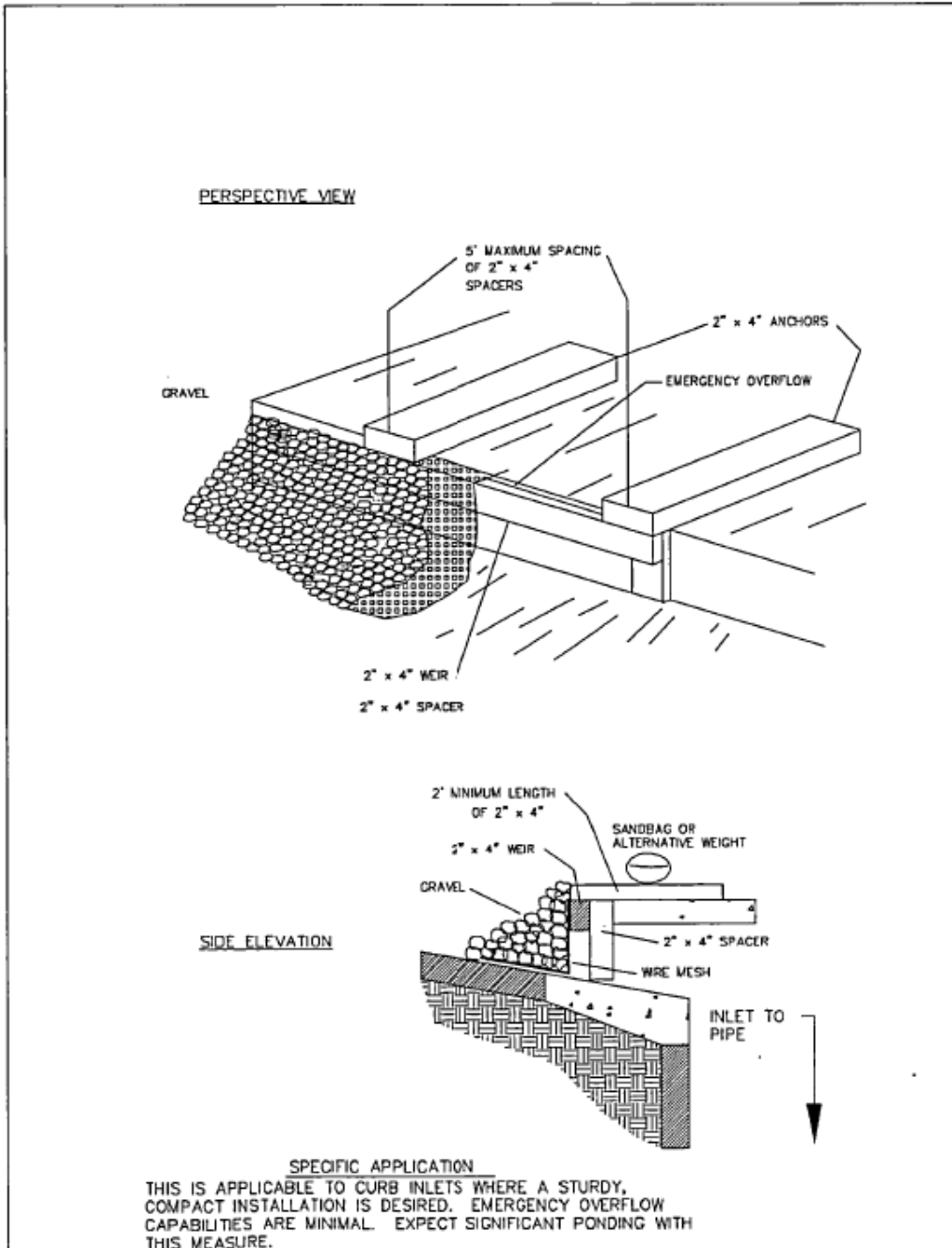

*Inlet protection detail*





## **BMP KIMBLE FILTER PIPE**

---

### **DESCRIPTION**

**A** Kimble filter is a perforated pipe (with an optional filter fabric wrap, depending on soil types) added to an existing inlet pipe, surrounded by washed rock.

### **PURPOSE**

The purpose of this BMP includes, but is not limited to:

- Filtering sediment from water entering existing pipe at construction area.

### **APPLICATIONS**

This BMP may be used in open drainage system maintenance and in conjunction with other BMPs.

### **LIMITATIONS**

This BMP should not be used:

- When the inlet elevation for the perforated pipe extension exceeds the surrounding bank height.
- To remove excessive fines unless the optional filter fabric is used.

### **CONSTRUCTION GUIDELINES**

- Secure perforated pipe onto existing pipe and wrap in filter fabric as needed.
- Fill washed rock high enough to ensure filtration.

### **BMP MAINTENANCE**

- Check outfall periodically. Revise methods if water is not running clear.

### **BMP REMOVAL**

- Evaluate site to determine BMP is no longer needed (the area has stabilized—potential of sediment laden water exiting the area has passed).
- Remove sediment buildup in front of BMP.
- Remove BMP (recycle and/or re-use if applicable).
- Re-vegetate area disturbed by BMP removal (if applicable).

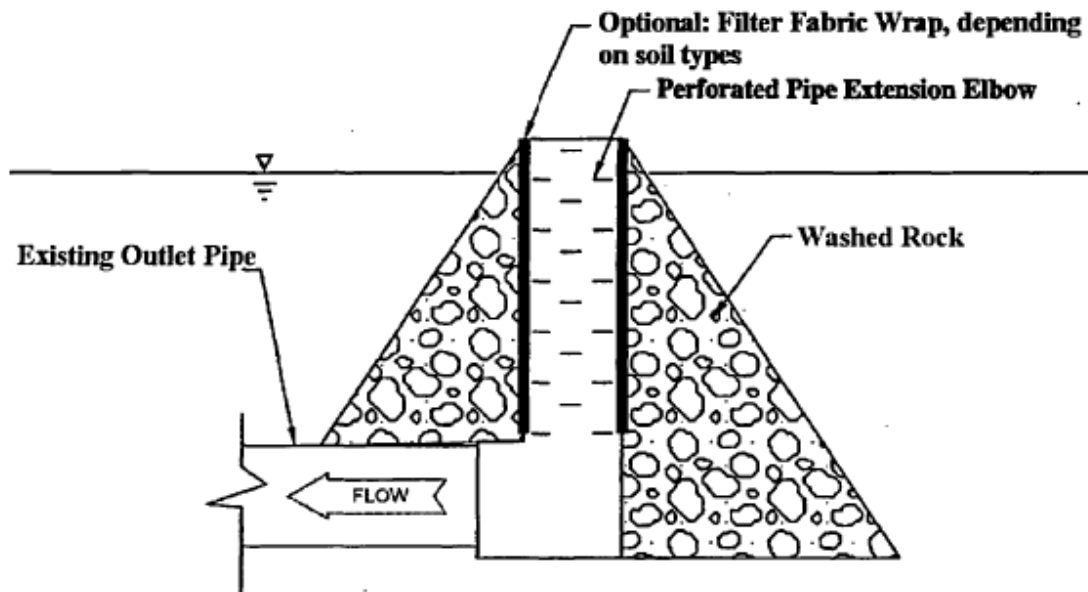

*Kimble filter detail*



## **BMP LARGE WOODY DEBRIS**

---

### **DESCRIPTION**

**L**arge woody debris is any large piece of woody material (including the trunk and root mass) that intrudes or is imbedded in the stream channel. Woody debris affects local flow velocities, streambed and streambank stability, and local stream characteristics. For example: see DOE, WSDFW, and/or King County Bank Stabilization Guidelines. Large Woody Debris is used to reduce water velocity/erosive forces and to provide habitat for fish.

### **PURPOSE**

The purpose of this BMP includes, but is not limited to:

- Improving aquatic habitat by re-directing flows away from eroding banks, providing cover, creating pools and storing sediment.
- Providing stream bed and bank stabilization.

### **APPLICATIONS**

When incorporating woody material into projects, it is necessary to identify the desired engineering performance and the desired habitat benefits. Each project must be specifically tailored to meet the engineering objectives identified for the habitat requirements of the target species. It can be used in combination with other BMPs.

### **LIMITATIONS**

This BMP should not be used:

- When the specific design requirements and desired habitat benefits have not been identified.
- Without consideration of the factors that influence the relative permanence of the wood in the stream channel.

### **CONSTRUCTION GUIDELINES**

- These will vary based on existing site conditions, design features, size and shape of the wood, its exposure to the forces exerted by moving water, and its resistance to movement because of wedging, or embedding with adjacent materials.
  - Construct in accordance with design, specifications and permit conditions.
-



### **BMP MAINTENANCE**

- Monitor the large woody debris to ensure it remains "as built" during construction.
- Consult a qualified biologist for specific repairs.

### **BMP REMOVAL**

- BMP removal is not applicable.



*Large woody debris placed in streambed to provide salmonid refuge. Note use of streambed gravel, dewatering with pump, and mulching*



BMP: LARGE WOODY DEBRIS (continued)

---



*Large woody debris placed in a streambed to provide salmonid refuge. Note use of turbidity curtain , streambed gravel, silt fence, coir fabric, mulching, and stream bypass*



*Large woody debris placed in streambed to provide fish refuge. Note use of streambed gravel, mulch, and coir fabric*

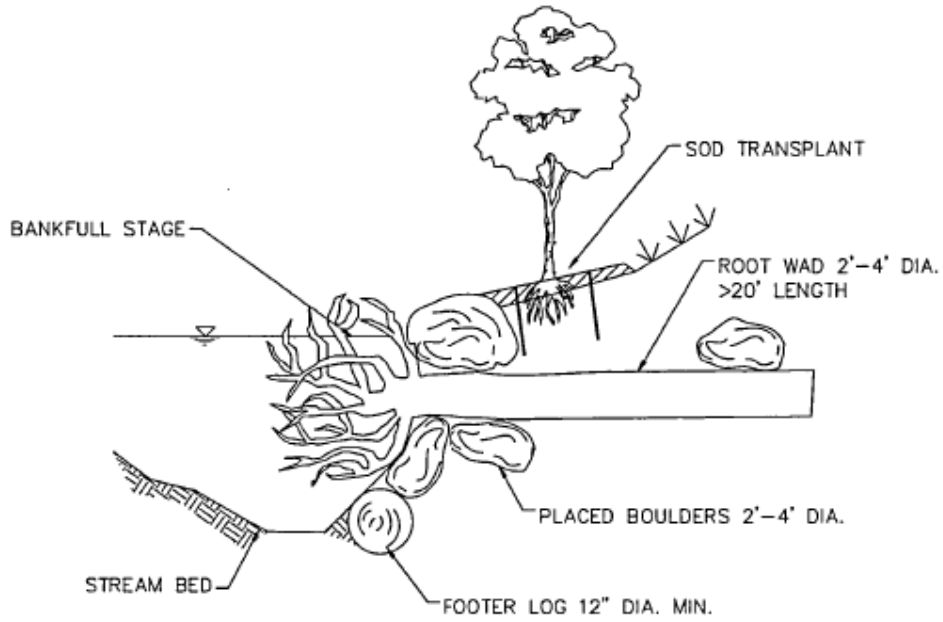

ROOT WAD: PLAN VIEW

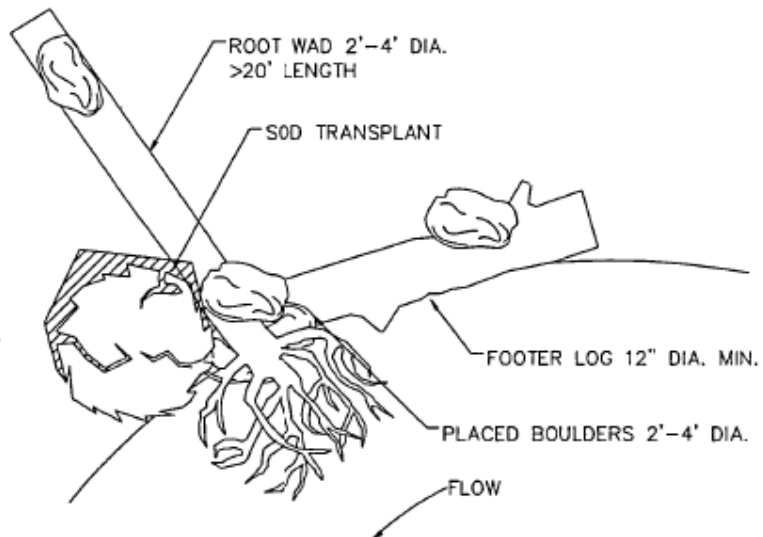

TYPICAL CROSS SECTION – NATURAL MATERIAL REVETMENT

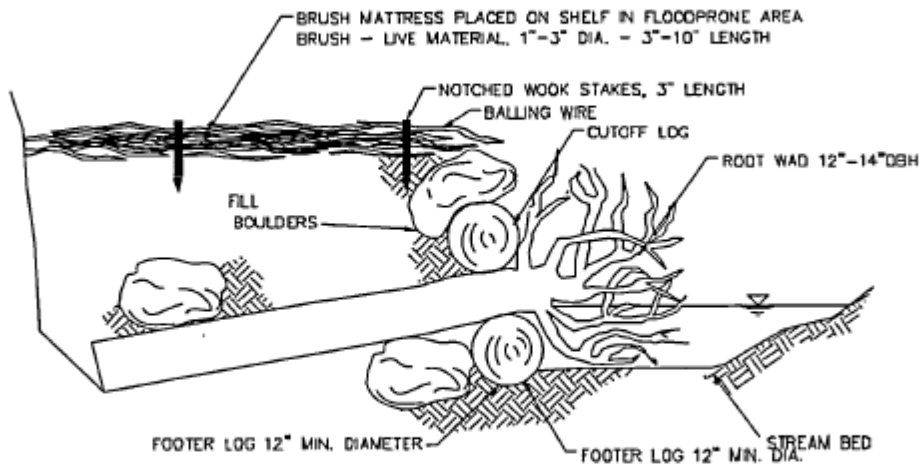

TYPICAL PLAN VIEW – NATURAL MATERIAL REVETMENT

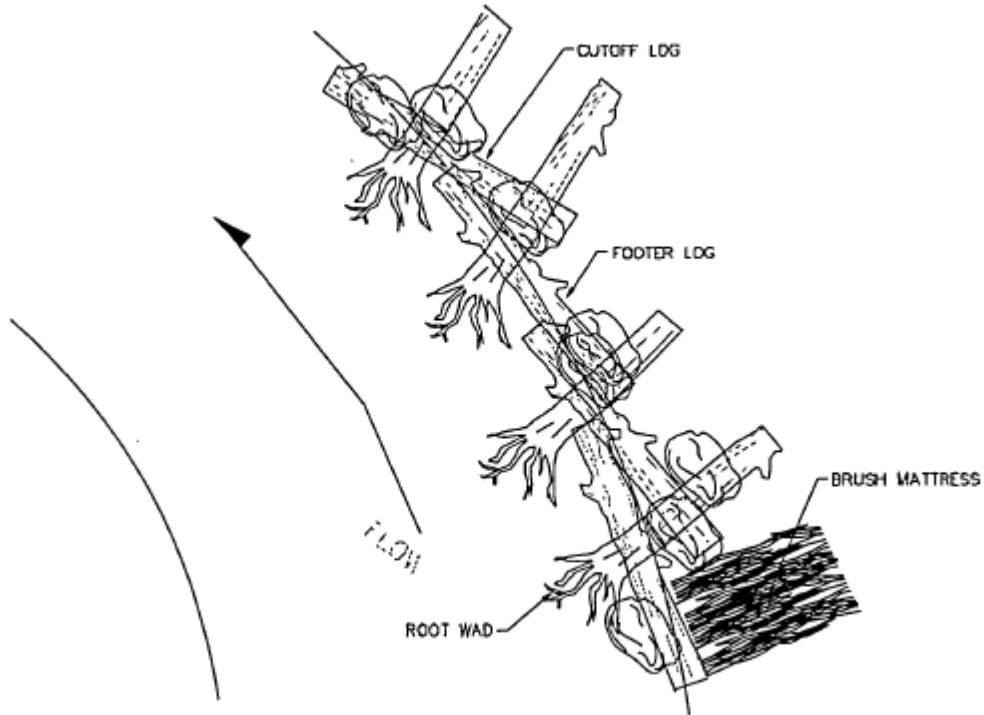

## **BMP LIVE STAKING**



---

### **DESCRIPTION**

**L**ive stake planting involves the insertion of live, vegetative cuttings into the ground in a manner that allows the cutting (stake) to take root and grow. This BMP is used to reduce potential for soil becoming water borne, to reduce water velocity/erosive forces after vegetation establishment, and to aid in habitat protection/maintenance.

### **PURPOSE**

The purpose of this BMP includes, but is not limited to:

- Using a system of live stakes to create a root mat that stabilizes the soil by reinforcing and binding soil particles together.
- Using it in conjunction with other practices to provide for an increase in site stability.
- Providing habitat and shade when planted along stream and/or watercourse banks.
- Providing habitat for primary production.
- Providing habitat for prey base organisms such as macro-invertebrates.

### **APPLICATIONS**

This BMP may be used to repair small earth slips and slumps. It may be used to reinforce or enhance stream channel banks. Live staking may be used to anchor and enhance the effectiveness of willow wattles (fascines), excelsior filled logs, backslope planting, coir logs/fabric, or other erosion control material.

### **LIMITATIONS**

This BMP should not be used:

- Where vegetation growth will interfere with maintenance and/or facility access.
- Where vegetation growth will interfere with sight distance and/or create safety issues.
- For immediate soil stabilization results.





### **CONSTRUCTION GUIDELINES**

- Live staking must be done in accordance with design and/or permit conditions.
- Harvesting and planting should optimally occur during the dormant season (late fall to early spring).
- Use healthy live wood that is at least one year old.
- Make a clean angular cut at the butt end. Cutting should be a minimum of 24-inches long (for best results, use 36-inch long cutting) and up to 3" in diameter.
- For best results, prior to installation, soak cuttings in water for a minimum of 24 hours.
- Use a pilot bar (or similar device) in firm soils to establish a planting hole.
- Plantings should be inserted into the ground 2/3 the length of the stake. Re-cut any damaged or split ends after installation.
- Tamp soil around stake.

### **BMP MAINTENANCE**

- Periodic inspection, repair and maintenance will be done in accordance with permit requirements. If no permits are required, vegetation will be monitored until the vegetation is established.
- Staked area may need to be watered during summer months.

### **BMP REMOVAL**

- BMP removal is not necessary.



*Staked streambank to provide vegetative cover once vegetation has established*



*Using straw and live staking to reduce erosion and provide vegetative cover once vegetation has established*

# Mulching

## BMP MULCHING



---

### DESCRIPTION

**M**ulching is the application of straw, wood chips, or other suitable materials on the soil surface applied manually or by machine. This BMP is used to reduce potential for soil becoming water or air borne and to reduce water velocity/erosive forces after vegetation establishment.

### PURPOSE

The purpose of this BMP includes, but is not limited to:

- Reducing erosion by protecting the soil surface from raindrop impact or wind.
- Decreasing surface water or wind velocity impacts.
- Fostering the growth of vegetation by increasing available moisture and providing insulation against extreme heat and cold.

### APPLICATIONS

This BMP can be used in areas to provide protection to the soil surface. Areas that have been seeded can be mulched to provide additional protection. This BMP may be used in combination with plantings of trees, shrubs, certain ground covers or in conjunction with seeding.

### LIMITATIONS

This BMP should not be used:

- On slopes steeper than 2 horizontal to 1 vertical.
- In watercourse and streams.
- In ditches where water flow is continuous.

### CONSTRUCTION GUIDELINES

- When used near watercourses or streams, this BMP must be used in accordance with permit requirements.
- Mulch should be applied so that the soil is covered sufficiently enough to allow seeds to germinate, but also protects the soil from erosion.
- Nets and matting may be used in combination with mulch.
- Various types and sizes of mulch are available.



- If used to stabilize soil from wind forces, the mulch needs to be tilled or incorporated into the soil.

### **BMP MAINTENANCE**

- During construction, inspect BMPs daily during the workweek. Schedule additional inspections during storm events. Make any required repairs.
- Additional mulch should be applied where erosion or scouring occurs.
- If a tear occurs in the cover netting or matting, repair as necessary.

### **BMP REMOVAL**

- BMP removal is not necessary under normal circumstances.



*Using straw to reduce erosion in a slide area prior to a major stabilizing project*

# Plastic Covering

## **BMP** **PLASTIC COVERING**



---

### **DESCRIPTION**

**P**lastic covering is used to cover exposed areas, which need immediate protection from erosion.

### **PURPOSE**

The purpose of this BMP includes, but is not limited to:

- Providing immediate temporary erosion protection to slopes, piles and disturbed areas that cannot be covered by mulching.
- Protecting exposed surfaces from water and/or wind erosion.
- Used in winter months as a temporary erosive control device when grass seed will not germinate.

### **APPLICATIONS**

This BMP may be used in disturbed areas, which require immediate erosion protection, areas seeded during winter and spring to aid in germination and for protection from heavy rain. Plastic covering may be used on steep slopes, construction sites and on stockpiles and/or excess materials. It may be used in combination with other BMPs.

### **LIMITATIONS**

This BMP should not be used:

- For long term erosion control.
- Without controlling surface water runoff from the plastic covered area.

### **CONSTRUCTION GUIDELINES**

- Plastic must be secured by staking or using weight (i.e. sandbag or tires) to prevent movement. Rebar must not be used as a staking mechanism.
- Plastic covering must be "keyed" in at the top of the slope.
- Additional BMPs, such as a berm and/or sediment control, must be used to control surface water runoff from plastic.

### **BMP MAINTENANCE**

- During construction, inspect BMPs daily during the workweek.
-



Schedule additional inspections during storm events. Make any required repairs.

- Replace damaged sections of plastic.

### BMP REMOVAL

- Evaluate site to determine BMP is no longer needed (the area has stabilized—potential of sediment laden water exiting the area has passed).
- Remove BMP (recycle and/or re-use if applicable).
- Re-vegetate area disturbed by BMP removal (if applicable).



*Plastic covering used as erosion protection on a slope at construction/repair area. Note additional use of mulch in area*

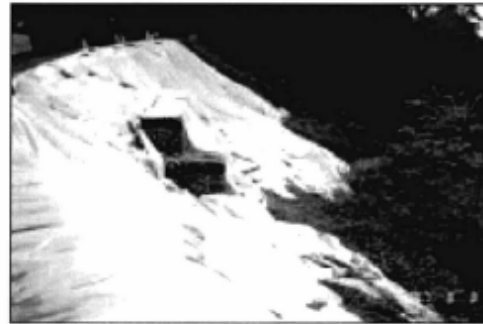

*Plastic covering used to protect exposed surface from erosion during construction/repair activities*



*Plastic covering used as a temporary erosion control on slope at slide area after storm and before repair*

# Plywood Work Platform

## **BMP** **PLYWOOD WORK PLATFORM**



---

### **DESCRIPTION**

A plywood work platform is a temporary work area under bridges or piers consisting of framework, plywood, scaffolding and/or tarps. This BMP is used to reduce the potential for debris and contaminants falling into water.

### **PURPOSE**

The purpose of this BMP includes, but is not limited to:

- Providing a safe and efficient working environment.
- Containing fallen debris (concrete, wood chips, sawdust, slag and metal) from entering water during construction, maintenance and repair activities.

### **APPLICATIONS**

This BMP may be used under most small timber bridges, pipelines or piers. It may be used in combination with other BMPs.

### **LIMITATIONS**

This BMP should not be used:

- Where spans exceed 16 feet from bent to bent.

### **CONSTRUCTION GUIDELINES**

- Framework is usually 4 in. x 6 in. joists 16 inches on center which span the stream.
- 3/4 in. x 4 ft. x 8 ft. plywood is placed flat and tight, edge to edge, on joists, and tacked with 6 d nails for easy removal.
- Tarps are placed over the plywood deck and draped vertically approximately 36 in. high at the abutment wall of the deck and over the hand rails at the other edges.
- A truck mounted bridge work platform may be an option, depending on location and scope of work.
- A fire extinguisher shall be on hand at all times for spark and fire suppression.
- Ensure that plywood platform and tarp do not enter the water.



### **BMP MAINTENANCE**

- During construction, inspect BMPs daily during the workweek. Schedule additional inspections during storm events. Make any required repairs.
- Crew must provide frequent clean up of debris during the day.
- Rips or tears in the tarp must be repaired.

### **BMP REMOVAL**

- Evaluate site to determine BMP is no longer needed.
- Remove debris on BMP.
- Remove BMP (recycle and/or re-use if applicable).
- Re-vegetate bridge abutment area disturbed by maintenance activities (if applicable).



*Plywood work platform providing a safe work environment and containing fallen debris from entering water during construction, maintenance, and repair activities*





---

## DESCRIPTION

**R**ip rap is a long-term, erosion-resistant ground cover. It is composed of large, loose, angular rock which may be used to stabilize embankments and ditches. An optional filter fabric or granular underlining may be used.

## PURPOSE

This BMP includes, but is not limited to:

- Protecting the soil from the erosive forces of concentrated runoff.
- Reducing the velocity of runoff while enhancing the potential for infiltration.

## APPLICATIONS

This BMP may be used for stabilization of steep slopes with seepage problems and/or unstable soils that need armoring to prevent sloughing, downstream turbidity, and roadway or shoulder failure. This BMP should be used as a last resort in locations where planting or other stabilizing methods are impracticable. Rip rap may also be used to fill minor washouts along ditch lines, at culvert exits and entrances and shoulders. It may be used in combination with other BMPs.

## LIMITATIONS

This BMP should not be used in watercourses or streams:

- Without permit review and approval.
- When maintenance activities could reduce actual or potential high flow salmonid refuge functions, this BMP will only be used if:
  - Required or allowed by permit conditions.
  - Required by other regulations.

For applications outside of watercourses or streams, there are no limitations, other than design constraints.

## CONSTRUCTION GUIDELINES

- In locations where permits are required, rip rap must be placed in accordance with design and/or permit conditions.



BMP: RIP RAP (continued)

---

- Remove unstable and unusable soil.
- Shape the sub-base to conform to site.
- Install fabric (if applicable).
- Place rip rap.

**MAINTENANCE**

- Inspect periodically to determine if high flows have caused scour beneath the rip rap or filter fabric.

**BMP REMOVAL**

- BMP removal may not be necessary. If BMP is removed, it should be done in accordance with design and applicable permits.



*Rip rap placed on slope for increased stability*



*Rip rap used to provide bank stability*

---

# Rock Check Dam

## BMP

### ROCK CHECK DAM



---

#### DESCRIPTION

A rock check dam is a small temporary or permanent dam constructed across a swale or drainage ditch. A rock check dam can be used to provide settling of soil particles and reduction in water velocity/erosive forces.

#### PURPOSE

The purpose of this BMP includes, but is not limited to:

- Reducing water velocity/erosive forces.
- Trapping soil particles generated from adjacent areas or the drainage ditch.

#### APPLICATIONS

Rock check dams may be used to aid in sediment trapping from a work site. It may be used in combination with other BMPs.

#### LIMITATIONS

This BMP should not be used:

- When maintenance activities could reduce actual or potential high flow salmonid refuge functions, this BMP will only be used if:
  - Required or allowed by permit conditions.
  - Required by other regulations.

For applications outside of watercourses or streams, there are no limitations, other than design constraints.

#### CONSTRUCTION GUIDELINES

- The maximum height of the dam shall be 3 feet.
  - The center of the check dam must be at least 6 inches lower than the outer edges.
  - For added stability, the base of the check dam can be keyed into the soil approximately 6 inches.
  - Maximum spacing between the dams should be such that the toe of the upgrade dam is at the same elevation as the top of the downgrade dam.
  - Filter fabric may be used under the stone to provide a stable foundation and to facilitate the removal of the rock.
-



- Use in small open channels.
- Refer to sketches on following pages for details.

#### **BMP MAINTENANCE**

- During construction, inspect BMPs daily during the workweek. Schedule additional inspections during storm events. Make any required repairs.
- Repair damaged BMPs due to end runs or undercutting.
- Sediment should be removed when deposits reach one-half the height of the BMP.
- Inspection on a regular basis should ensure that the center of the dam is lower than the edges. Erosion around the edges of the dam should be corrected.

#### **BMP REMOVAL**

- Evaluate site to determine BMP is no longer needed (the area has stabilized—potential of sediment laden water exiting the area has passed).
- Remove sediment buildup in front of BMP.
- Remove BMP (recycle and/or re-use if applicable).
- Re-vegetate area disturbed by BMP removal (if applicable).



*Rock check dam in ditch to provide reduction in water velocity*

---



### ROCK CHECK DAM

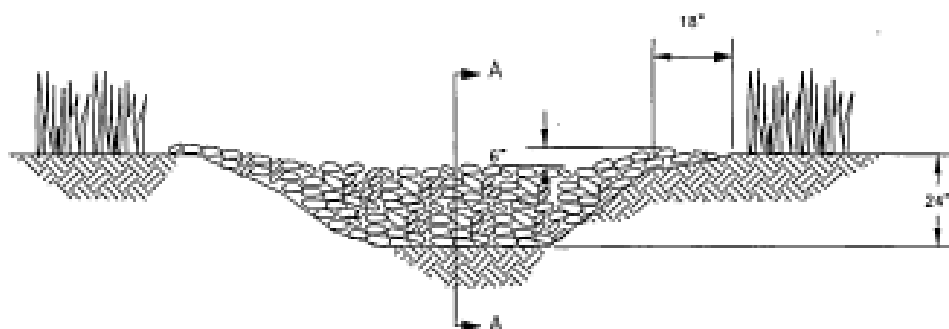

**NOTE**

KEY STONES INTO CHANNEL BANKS AND EXTEND IT BEYOND THE ABUTMENTS 18" (MIN.) TO PREVENT FLOW AROUND DAM.

### SPACING BETWEEN CHECK DAMS

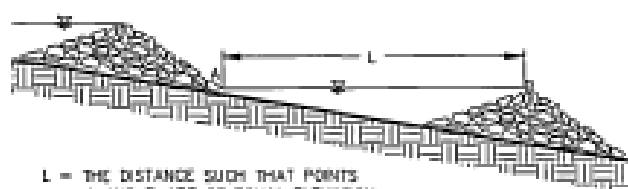

L = THE DISTANCE SUCH THAT POINTS A AND B ARE OF EQUAL ELEVATION

### SECTION A-A

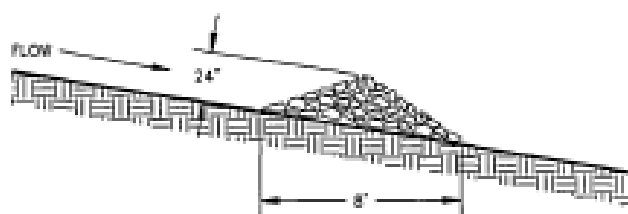

# Sandbag

## **BMP** **SANDBAG**



---

### **DESCRIPTION**

A sandbag is a pre-manufactured cloth or plastic bag (polypropylene) filled with sand or gravel. Sandbags can be used to keep water from the work area, for settling and reduction in water velocity/erosive forces.

### **PURPOSE**

The purpose of this BMP includes, but is not limited to:

- A barrier.
- A protective barrier against flooding.
- Using in combination with other methods, to form a cofferdam.
- Using as a sediment filter (when used with clean pea gravel).
- Using as a ballast.
- Other multi-purpose situations.

### **APPLICATIONS**

Sandbags may be used during emergencies to build walls and control the flow and level of water. It may be used in combination with other barriers.

This BMP may be used during construction to form walls in dewatered areas, for example, cofferdams, and for various other impromptu situations.

### **LIMITATIONS**

This BMP should not be used:

- Where permit conditions state otherwise.
- When maintenance activities conducted in locations could reduce actual or potential high flow salmonid refuge functions, this BMP will be used if required by permit conditions.

### **CONSTRUCTION GUIDELINES**

- When used in watercourses or streams, this BMP must be used in accordance with permit requirements.
- Refer to Appendix B for Fish Exclusion Protocols.
- If sandbag filling is to be used as streambed gravel, it must be washed prior to filling bags, appropriately sized according to design and placed in accordance with permit conditions. Wash rock off-site (at a location where washed water can not enter watercourses, streams or wetlands) until water runs clear.
- Secure ends of sandbags to ensure material does not scatter.



- When used as a barrier, stack bags tightly together and in alternating, brick-layer fashion.

#### **BMP MAINTENANCE**

- During construction, inspect BMPs daily during the workweek. Schedule additional inspections during storm events. Make any required repairs.
- Replace damaged sandbags.
- Repair damaged sandbag berm due to end runs or undercutting.
- Sediment should be removed when deposits reach one-half the height of the BMP.
- Check bags often for seepage and replace or add as needed.

#### **BMP REMOVAL**

- Evaluate site to determine BMP is no longer needed (the area has stabilized—potential of sediment laden water exiting the area has passed).
- Remove sediment buildup in front of BMP.
- Remove BMP (recycle and/or re-use if applicable).
- Re-vegetate area disturbed by BMP removal (if applicable).
- Gravel filled bags may be split and the contents left in place, in streams, when so stated in the specific permit conditions (Bags are to be removed from job site).



*Sandbags acting as a barrier*



*A sandbag barrier used to decrease water velocity. Note use of silt mat and hydroseeding to decrease erosion and to increase vegetation in channel*



*Sandbags holding bypass pipe in place and detaining sediment laden water on site*





*Sandbags filled with washed rock acting as a filter*



*Sandbags used in combination with plastic and strawbales serving as a barrier*

# Sediment Sump

## **BMP SEDIMENTATION SUMP**



---

### **DESCRIPTION**

**S**edimentation sumps provide a sump within the flow line of ditches, swales, or channels to allow soil particles to collect and settle.

### **PURPOSE**

The purpose of this BMP includes, but is not limited to:

- Collecting soil particles by settlement.

### **APPLICATIONS**

This BMP may be used in areas where water quantity or velocities within steeper sloped ditches, swales, or channels are transporting sediment or material and impacting structures or habitat. It may be used in conjunction with other BMPs.

### **LIMITATIONS**

This BMP should not be used:

- To remove excessive fines.

### **CONSTRUCTION GUIDELINES**

- Place rim of structure at flow line elevation.
- Structures can be sized based on the quantity of soil particles and space availability within the transport facility.
- Structures can be placed with other BMPs such as ditch linings or grass lining.
- Structures can be placed in transport facilities where they collect sediment prior to pipe crossings into streams, wetlands, sensitive areas, or structures that easily plug with sediment.

### **BMP MAINTENANCE**

- Structures should be monitored after rainfall events for determination of cleaning schedule and frequency.
- Structures can be cleaned when necessary utilizing vactor truck used in cleaning of catch basins.

### **BMP REMOVAL**

- BMP removal is not necessary.



## **BMP SILT FENCE**

---

### **DESCRIPTION**

A silt fence is a temporary sediment barrier consisting of fabric stretched across and attached to supporting posts and entrenched into the soil. It is generally installed perpendicular to the flow direction to slow or stop water and to allow filter/perimeter protection, settling of soil particles, and/or reduce water velocity/erosive forces.

### **PURPOSE**

The purpose of this BMP includes, but is not limited to:

- Intercepting sheet flow.
- Intercepting and detaining small amounts of water from disturbed areas during construction operations in order to allow for filtering or settling of soil particles.
- Decreasing down slope sheet flow velocity.
- Retain soil particles on site.

### **APPLICATIONS**

This BMP may be used for perimeter protection. It may be used in combination with other BMPs.

This BMP may be used below disturbed areas subject to sheet and rill erosion where drainage area is no greater than .25 acre per 100 lineal feet of barrier and the slope behind the barrier should be no steeper than 2 horizontal feet to 1 vertical foot. On relatively flat slopes, the maximum disturbed slope distance should not exceed 100 feet. The allowable disturbed slope distance decreases as the slope gets steeper.

### **LIMITATIONS**

This BMP should not be used:

- Where rock or hard surfaces prevent the full and uniform anchoring of the barrier.
- Directly in perennial streams or water courses.
- Around drop inlets.
- In front of storm drain inlets.
- As a diversion dam.

### **CONSTRUCTION GUIDELINES**

- The BMP should be placed along contours.
-



- The bottom of the fabric must be continuously and securely anchored for its entire length to prevent undermining.
- The height of the fence shall be adequate to reduce the potential of silt from leaving the job site.
- There must be at least a 3-foot overlap at vertical seams to avoid leakage. Both ends of the overlap must be securely attached to posts.
- Increase the elevation at the ends of the BMP installation to prevent "end runs."

### **BMP MAINTENANCE**

- During construction, inspect BMPs daily during the workweek. Schedule additional inspections during storm events. Make any required repairs.
- Replace damaged sections of fabric.
- Repair damaged BMPs due to end runs or undercutting.
- Sediment should be removed when deposits reach one-half the height of the BMP.

### **BMP REMOVAL**

- Evaluate site to determine BMP is no longer needed (the area has stabilized- potential of sediment laden water exiting the area has passed).
- Remove sediment buildup in front of BMP.
- Remove BMP (recycle and/or re-use if applicable).
- Re-vegetate area disturbed by BMP removal.



*Silt fence being installed on a temporary access road; used as perimeter protection*



BMP: SILT FENCE (continued)

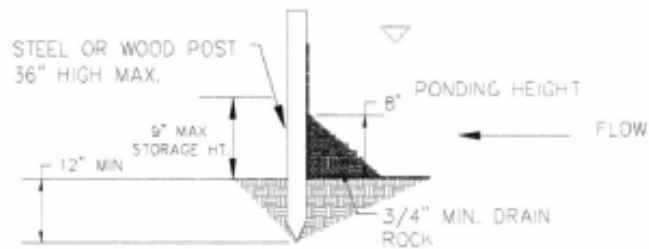
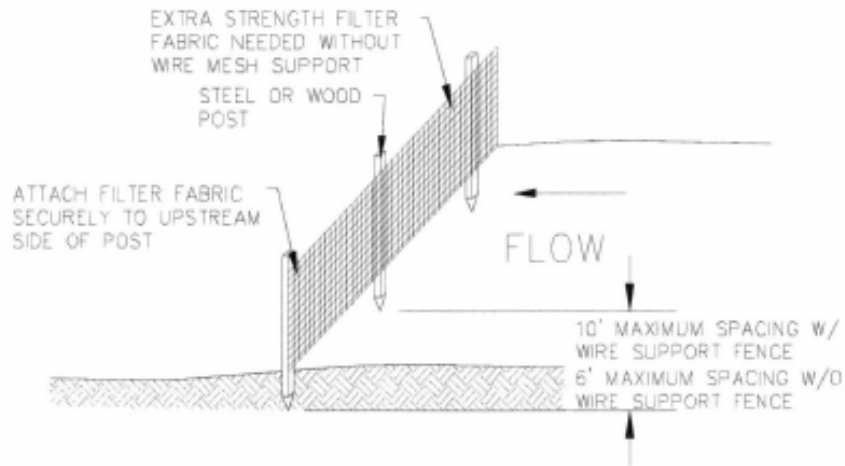

INSTALLATION WITHOUT TRENCHING

NOTES

1. SILT FENCE SHALL BE PLACED ON SLOPE CONTOURS TO MAXIMIZE PONDING EFFICIENCY.
2. AFTER STORM EVENT, INSPECT AND REPAIR FENCE. REMOVE SEDIMENT AS NECESSARY. 9" MAX. STORAGE HEIGHT IS RECOMMENDED.
3. REMOVED SEDIMENT SHALL BE DEPOSITED TO AN AREA THAT WILL NOT CONTRIBUTE SEDIMENT OFF-SITE AND THAT CAN BE STABILIZED.

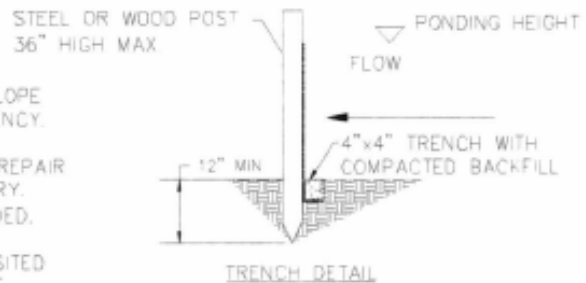

## **BMP SILT MAT**



---

### **DESCRIPTION**

A silt mat is a flat pre-manufactured pad made in three layers: jute mesh, excelsior, and burlap. The pads are 4 feet by 10 feet and are biodegradable. Sediment passes through the mat layers and is held by the burlap layer. Silt mats can be used to provide filter/perimeter protection, settling and reduction in water velocity/erosive forces.

### **PURPOSE**

The purpose of this BMP includes, but is not limited to:

- Intercepting and detaining small amounts of soil particles.
- Preventing erosion at discharge points.

### **APPLICATIONS**

It may be used at pump discharges, pipe outlets, and/or downstream of work sites to retain soil particles and provide stabilization. It may also be used in ditch lines. It may be used in combination with other BMPs.

### **LIMITATIONS**

This BMP should not be used:

- As the only BMP when excessive soil particles are present.
- In high flow rates.

### **CONSTRUCTION GUIDELINES**

- This BMP may be used singly or in a group on the streambed immediately downstream of a work site.
- Silt mats should be installed with either staples or stakes.
- There is no need for disposal. Place on adjacent slope or leave in place after use and add seed and mulch to stabilize the slope.
- Joints need to be overlapped according to flow.

### **BMP MAINTENANCE**

- During construction, inspect BMPs daily during the workweek. Schedule additional inspections during storm events. Make any required repairs.
-



- Sediment loads should be monitored frequently to ensure the silt mat's capacity load is not exceeded. Replace silt mats before capacity is reached. (Unless used in conjunction with re-vegetation).
- Check periodically for gaps.

### **BMP REMOVAL**

- Evaluate site to determine BMP is no longer needed (the area has stabilized—potential of sediment laden water exiting the area has passed).
- Remove BMP (recycle and/or re-use if applicable).
- Silt mat may be incorporated into permanent stabilization/re-vegetation process.
- Re-vegetate area disturbed by BMP removal (if applicable).



*Silt mat installed in ditch to decrease erosion  
and allow settlement of suspended solids*

# Siltation Pond

## **BMP** **SILTATION POND/SETTLING TANK**



---

### **DESCRIPTION**

A siltation pond/settling tank is a temporary containment structure or area for silt laden water to be initially discharged. After sufficient settling, the water may be discharged to sanitary sewer, storm drainage system or other BMP.

### **PURPOSE**

The purpose of this BMP includes, but is not limited to:

- Allowing soil particles to settle prior to water being discharged off-site.
- Settling water borne soil particles on site.
- Controlling the flow of water through a settling tank may require a control structure such as a tee fitting, an oil water separator or an orifice.

### **APPLICATIONS**

This BMP may be used wherever silt laden water must be removed from a construction site. It may be used in combination with other BMPs.

### **LIMITATIONS**

This BMP (Siltation Pond) should not be used:

- In soils that are not compatible for filtration, unless a liner is used.
- If there is inadequate space to process the volume of sediment-laden water.

### **CONSTRUCTION GUIDELINES**

- Silt ponds must be installed according to applicable permit requirements.
- Water discharged from siltation pond/settling tank shall meet permit requirements at the point of discharge.
- If an existing Retention/Detention facility or Settling Pond is near by, it may be utilized.
- Check site to determine if there is adequate space for pond excavation.
- Portable tanks may be used where ponds can not be constructed.
- Siltation pond should be designed according to surface water design standards.





- An optional liner may be used in ponds where soils are incompatible with filtration.

### **BMP MAINTENANCE**

- During construction, inspect BMPs daily during the workweek. Schedule additional inspections during storm events. Make any required repairs.
- Inspect filtering or control devices frequently. Repair or replace them to ensure that the structure functions as designed.

### **BMP REMOVAL**

- Evaluate site to determine pond/tank is no longer needed (the area has stabilized—potential of sediment laden water exiting the area has passed).
  - Follow engineer's recommendations for removal of BMP.
  - Recycle excess construction materials if feasible.
  - When siltation pond is removed it shall be in such a manner as to minimize disturbance. Remaining sediment shall be removed and/or disposed of according to permit conditions.
- Re-vegetate area disturbed by BMP removal according to permit (if applicable).



*Large silt pond with turbidity curtain in place*



*A settling tank in use to allow onsite containment of water borne soil particles*



*Settling tank*



### **BMP SOIL STABILIZATION (BLANKETS AND MATTING)**

---

#### **DESCRIPTION**

Soil stabilization can be accomplished through the installation of a protective blanket (covering) or a soil stabilization mat on a prepared planting area, a steep slope, channel and/or shoreline.

#### **PURPOSE**

The purpose of this BMP includes, but is not limited to:

- Reducing erosion.
- Providing a microclimate that protects young vegetation and promotes its establishment.
- "Reinforcing the turf" to resist the forces of erosion during storm events.

#### **APPLICATIONS**

This BMP may be used on short, steep slopes where erosion hazard is high and planting is likely to be slow in establishment. It may also be used on stream banks or tidal shorelines where moving water is likely to wash out new plantings. Soil stabilization blankets and matting may be used in combination with other BMPs.

#### **LIMITATIONS**

This BMP should not be used:

- In watercourses or streams without proper permits.

#### **CONSTRUCTION GUIDELINES**

- Installation is site specific.
- See following drawings and specifications.

#### **BMP MAINTENANCE**

- If vegetation is incorporated, inspect during the plant establishment period. Re-plant, due to mortality, as necessary.
- Schedule additional inspections during storm events. Check for erosion or undermining; any required repairs shall be made.

#### **BMP REMOVAL**

- BMP removal is not necessary.
-



*Stabilizing the soil in a sensitive area using blankets*



*Lining a ditch with soil stabilization matting to reduce erosion*



*Stabilizing the soil using matting and hydroseeding*



BMP: SOIL STABILIZATION (BLANKETS AND MATTING) (continued)

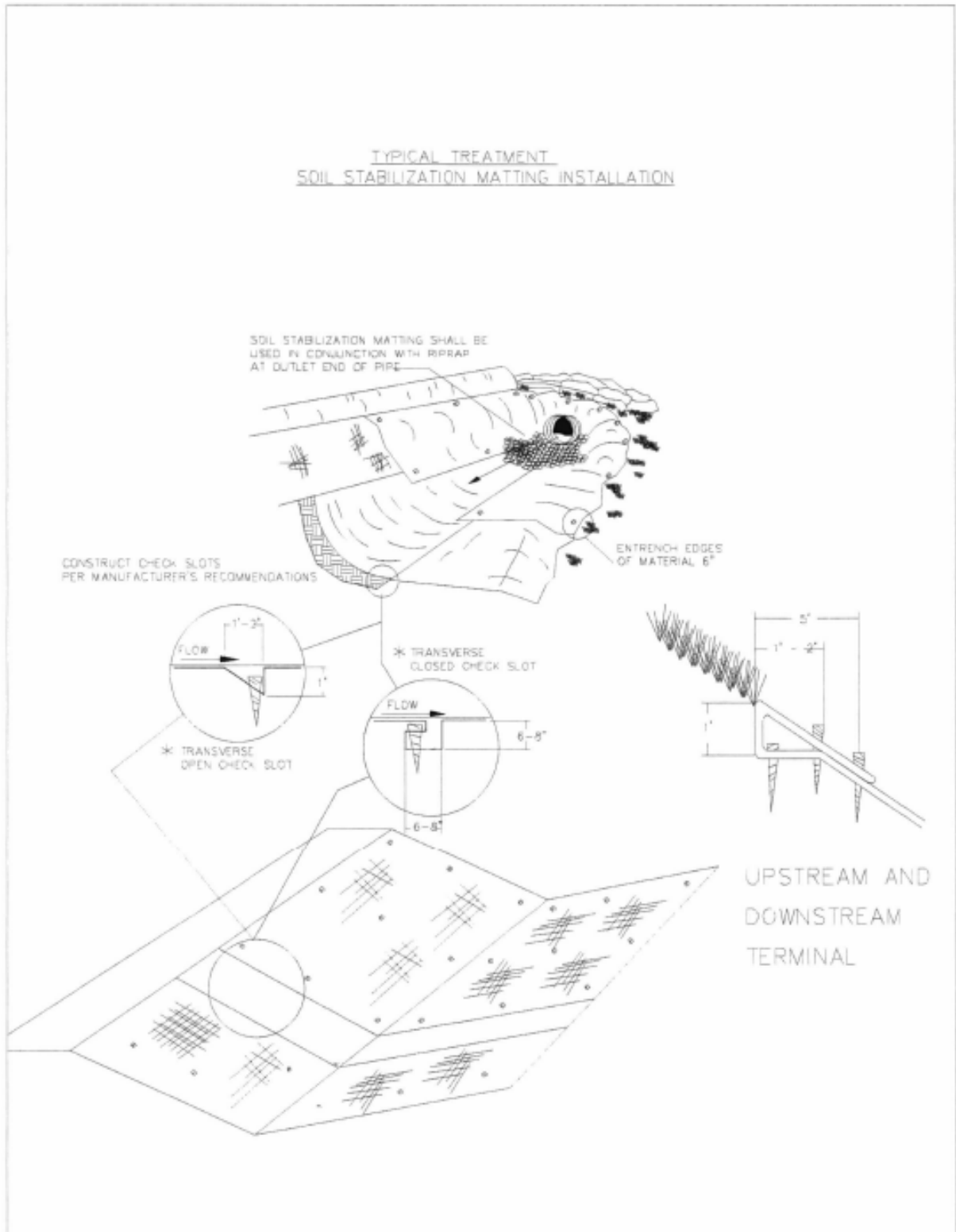



BMP: SOIL STABILIZATION (BLANKETS AND MATTING) (continued)

TYPICAL TREATMENT  
SOIL STABILIZATION MATTING SLOPE INSTALLATION

FILL SLOPE SECTION

SOIL STABILIZATION MATS SHOULD BE INSTALLED VERTICALLY DOWNSLOPE.

NOTE: SLOPE SURFACE SHALL BE SMOOTH AND FREE OF ROCKS, LIMPS OF DIRT, GRASS AND STICKS. MAT SHALL BE PLACED FLAT ON SURFACE TO ENSURE PROPER SOIL CONTACT.

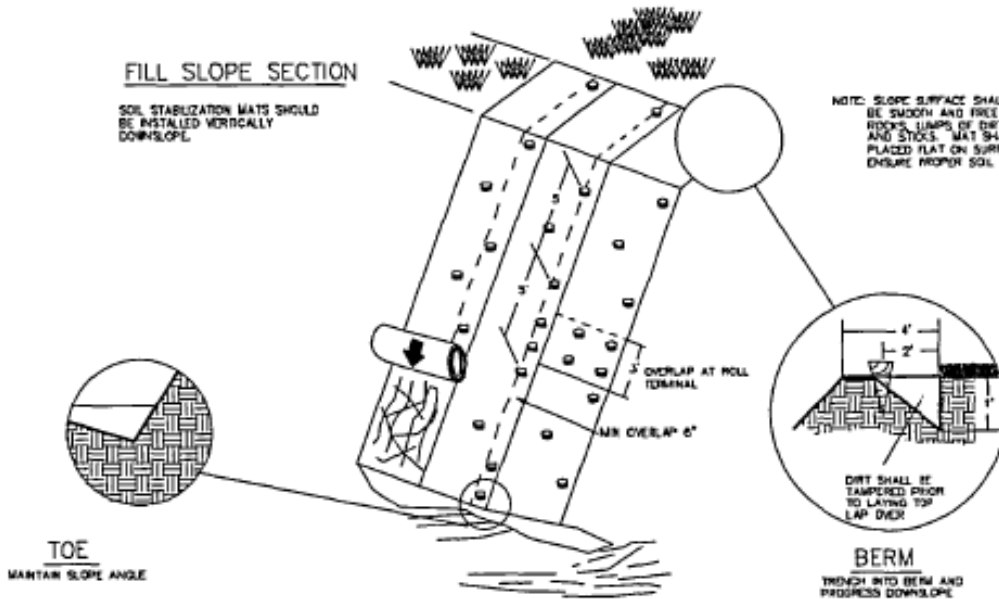

SLOPE LINING  
(WET SLOPE)

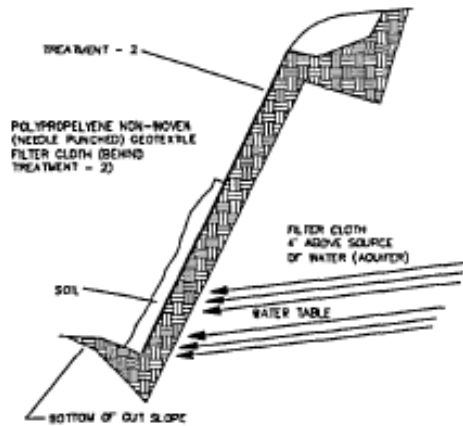

SLOPE LINING  
(DRY SLOPE)

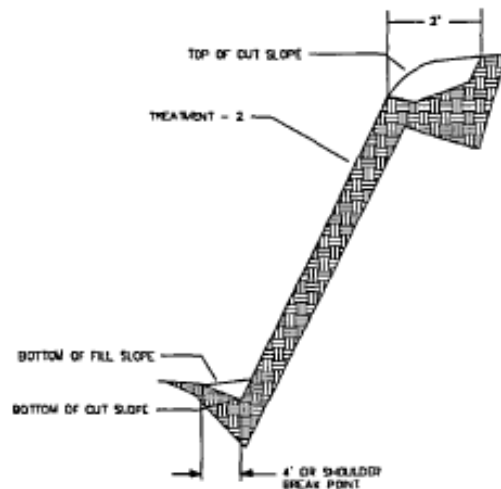

# GENERAL STAPLE PATTERN GUIDE AND RECOMMENDATIONS AND (SOIL STABILIZATION MATTING)

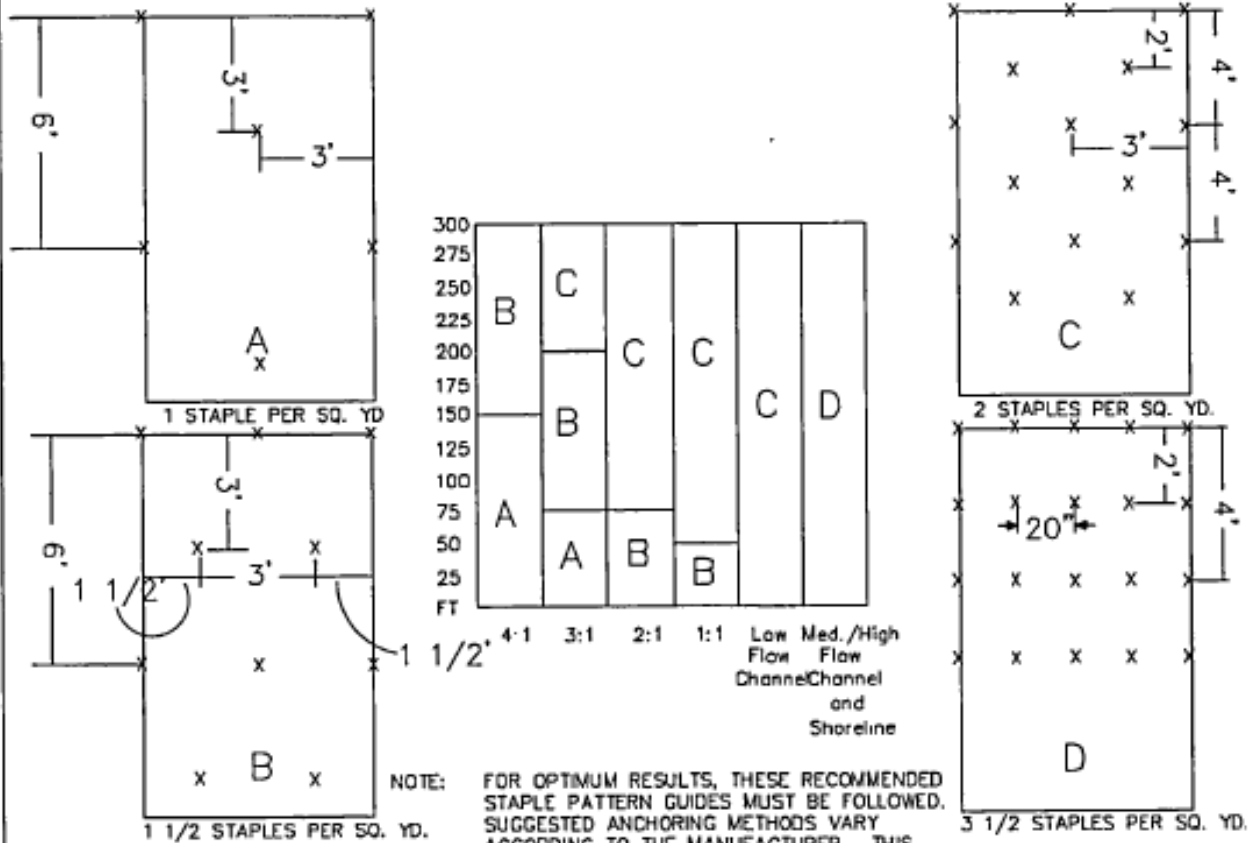

## **BMP STRAW BALE BARRIER (1)**



---

### **DESCRIPTION**

**A** strawbale barrier (1) is a small temporary barrier constructed across a non-fish bearing swale, gully, or drainageway. It is generally installed perpendicular to the flow direction to slow or stop water and to allow filter/perimeter protection, settling of soil particles, and/or reduce water velocity/erosive forces.

### **PURPOSE**

The purpose of this BMP includes, but is not limited to:

- Intercepting sheet flow.
- Intercepting and detaining small amounts of soil particles from disturbed areas during construction operations in order to allow settling of soil particles.
- Decreasing down slope sheet flow velocity.
- Retaining soil particles on site.

### **APPLICATIONS**

This BMP may be used in areas where permanent stabilization cannot be accomplished immediately. It may be used in combination with other BMPs.

### **LIMITATIONS**

This BMP should not be used:

- Where rock or hard surfaces prevent the full and uniform anchoring of the barrier.
- When maintenance activities could reduce actual or potential high flow salmonid refuge functions, this BMP will only be used if:
  - Required or allowed by permit conditions.
  - Required by other regulations.
- Where flow volume or water velocity inhibit BMP function.

### **CONSTRUCTION GUIDELINES**

- Place bales in a single row perpendicular to the flow, with ends tightly abutting one another.





## BMP: STRAW BALE BARRIER (1) (continued)

---

- The bottoms of the end bales should be placed higher in elevation than the top of the middle bale spillway to ensure sediment-laden runoff will flow over the barrier, and not around it.
- Bales shall be installed so that bindings are oriented around the sides rather than on the tops and bottoms, to prevent deterioration.
- Bales shall be entrenched a minimum of 4 inches.
- Gaps between bales shall be sealed by wedging straw in the space to limit escaping water.
- Bales shall be securely anchored by at least two stakes driven into the ground a minimum depth of 18 inches.
- See following pages for construction guidelines and additional detail.

### **BMP MAINTENANCE**

- During construction, inspect BMPs daily during the workweek. Schedule additional inspections during storm events.
- Any required repairs shall be made. (Repair any damaged BMPs due to end runs or undercutting).
- Sediment should be removed when deposits reach one-half the height of the BMP.

### **BMP REMOVAL**

- Evaluate site to determine BMP is no longer needed (the area has stabilized—potential of sediment laden water exiting the area has passed).
- Remove sediment buildup in front of BMP.
- Remove BMP.
- Re-vegetate area disturbed by BMP removal.





### PROPERLY INSTALLED STRAW BALE (CROSS SECTION)

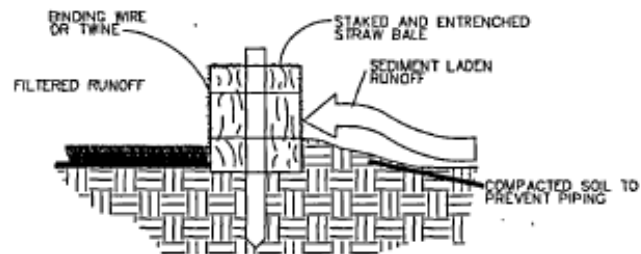

### CONSTRUCTION OF STRAW BALE BARRIER

1. EXCAVATE THE TRENCH

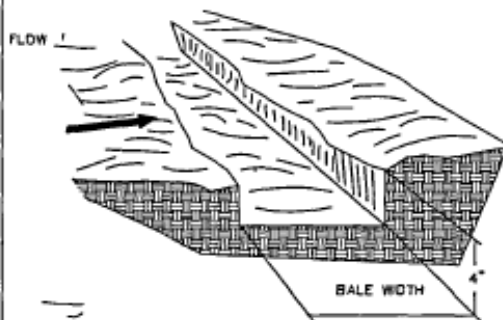

2. PLACE AND STAKE STRAW BALES

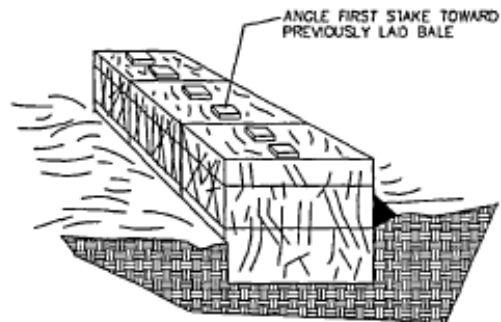

WEDGE LOOSE STRAW BETWEEN BALES

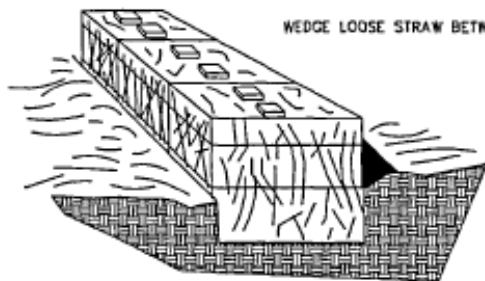

3. WEDGE LOOSE STRAW BETWEEN BALES

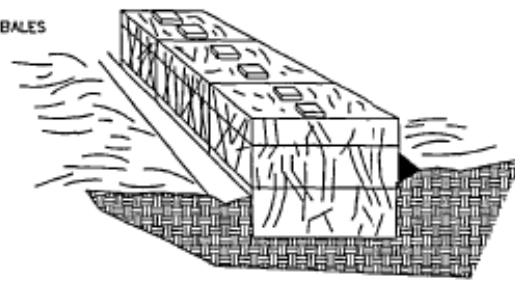

4. BACKFILL AND COMPACT THE EXCAVATED SOIL



## **BMP STRAW BALE BARRIER (2)**

---

### **DESCRIPTION**

A straw bale barrier (2) is a temporary sediment barrier consisting of a row of entrenched and anchored straw bales. It is generally installed perpendicular to the flow direction to slow or stop water and to allow filter/perimeter protection, settling of soil particles, and/or reduce water velocity/erosive forces.

### **PURPOSE**

The purpose of this BMP includes, but is not limited to:

- Intercepting sheet flow.
- Intercepting and detaining small amounts of water from disturbed areas during construction operations in order to allow settling of soil particles.
- Decreasing down slope sheet flow velocity.
- Retaining sediment on site.

### **APPLICATIONS**

This BMP may be used for perimeter sediment control. It may be used in combination with other barriers.

This BMP may be used below disturbed areas subject to sheet and rill erosion where drainage area is no greater than .25 acre per 100 lineal feet of barrier and the slope behind the barrier should be no steeper than 2 horizontal to 1 vertical. On relatively flat slopes the maximum disturbed slope distance should not exceed 100 feet. The allowable disturbed slope distance decreases as the slope gets steeper.

### **LIMITATIONS**

This BMP should not be used:

- Where rock or hard surfaces prevent the full and uniform anchoring of the barrier.
  - Directly in watercourses or streams when fish are present.
  - When maintenance activities could reduce actual or potential high flow salmonid refuge functions, this BMP will only be used if:
    - Required or allowed by permit conditions.
-



- Required by other regulations.
- Where flow volume or water velocity inhibit BMP function.

### **CONSTRUCTION GUIDELINES**

- Bales shall be placed in a single row, lengthwise on the contour, with ends of adjacent bales tightly abutting one another. (If area does not allow a single row, additional rows need to be installed in a staggered fashion).
- Bales shall be installed so that bindings are oriented around the sides rather than on the tops and bottoms, to prevent deterioration.
- Bales shall be entrenched a minimum of 4 inches.
- Bales shall be securely anchored by at least two stakes driven into the ground a minimum depth of 18 inches.
- Gaps between bales shall be sealed by wedging straw in the space to limit escaping water.
- Loose straw scattered over the area immediately uphill from the bale may increase barrier efficiency.
- See following pages for construction guidelines and additional detail.

### **BMP MAINTENANCE**

- During construction, inspect BMPs daily during the workweek. Schedule additional inspections during storm events.
- Any required repairs shall be made. (Repair any damaged BMPs due to end runs or undercutting).
- Sediment should be removed when deposits reach one-half the height of the BMP.

### **BMP REMOVAL**

- Evaluate site to determine BMP is no longer needed (the area has stabilized—potential of sediment laden water exiting the area has passed).
- Remove sediment buildup in front of BMP.
- Remove BMP (recycle and/or re-use if applicable).
- Re-vegetate area disturbed by BMP removal.



BMP: STRAW BALE BARRIER (2) (continued)

---



*Straw Bale Barrier (2) reducing water velocity and erosive forces. Note other BMPs also being used*



## STRAW BALE CHECK DAM

PLAN

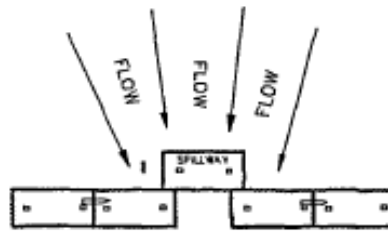

VIEW LOOKING UPSTREAM

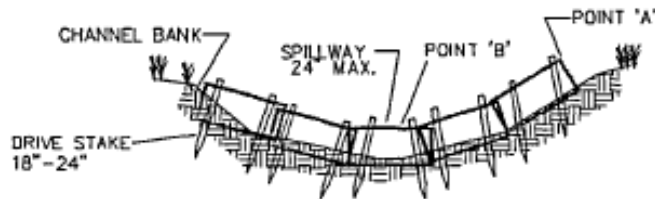

SECTION A - A

SPACING BETWEEN CHECK DAMS

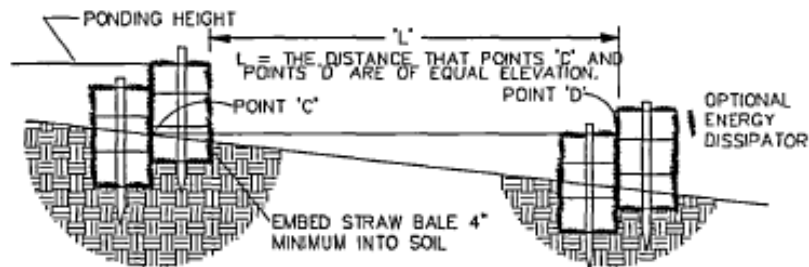

NOTES:

1. EMBED BALES 4" INTO THE SOIL AND 'KEY' BALES INTO THE CHANNEL BANKS.
2. POINT 'A' MUST BE HIGHER THAN POINT 'B' (SPILLWAY HEIGHT).
3. PLACE BALES PERPENDICULAR TO THE FLOW WITH ENDS TIGHTLY ABUTTING
4. SPILLWAY HEIGHT SHALL NOT EXCEED 24".



BMP: STRAW BALE BARRIER (2) (continued)

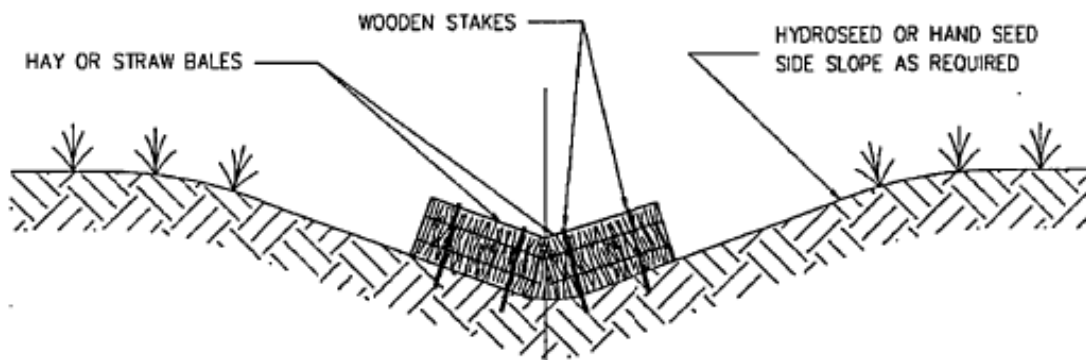
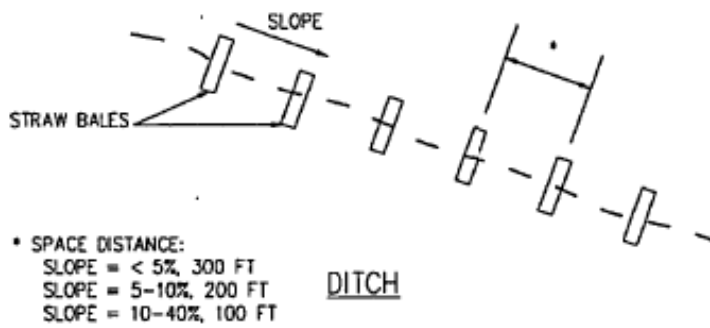
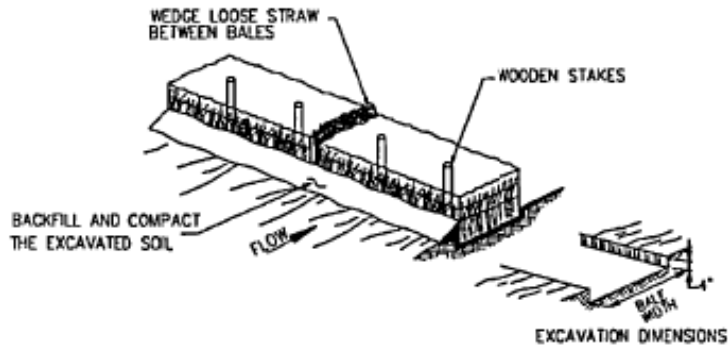

STRAW BALE BARRIER

N.T.S.



## Straw Bale Barrier 3

### **BMP** **STRAW BALE BARRIER (3)**



---

#### **DESCRIPTION**

A straw barrier (3) is a temporary barrier consisting of straw bales and a rock spillway placed across small drainage areas or gently sloping swales. It is generally installed perpendicular to the flow direction to slow or stop water and to allow filter/perimeter protection, settling of soil particles, and/or reduce water velocity/erosive forces.

#### **PURPOSE**

The purpose of this BMP includes, but is not limited to:

- Intercepting sheet flow.
- Intercepting and detaining small amounts of water from disturbed areas during construction operations in order to allow settling of soil particles.
- Allowing runoff to flow through or over the barrier.
- Decreasing runoff velocity.
- Retaining sediment on site.

#### **APPLICATIONS**

This BMP may be used in small channel flow situations. The rock size used in the spillway can be enlarged to accommodate larger flows.

#### **LIMITATIONS**

This BMP should not be used:

- Where rock or hard surfaces prevent the full and uniform anchoring of the barrier.
- Directly in watercourses or streams when fish are present.
- When maintenance activities could reduce actual or potential high flow salmonid refuge functions, this BMP will only be used if:
  - Required or allowed by permit conditions.
  - Required by other regulations.
  - Where flow volume or water velocity inhibit BMP function.

#### **CONSTRUCTION GUIDELINES**

- Maximum height of the spillway shall be 2 feet.



- See following pages for construction guidelines and additional detail.
- Bales shall be installed so that bindings are oriented around the sides rather than on the tops and bottoms, to prevent deterioration.
- Bales shall be entrenched a minimum of 4-inches.
- Bales shall be securely anchored by at least two stakes driven into the ground a minimum depth of 18 inches.

### **BMP MAINTENANCE**

- Inspect bales periodically and after each significant rainfall.
- Sediment shall be removed when it reaches one-half the height of the bale.

### **BMP REMOVAL**

- Evaluate site to determine BMP is no longer needed (the area has stabilized—potential of sediment laden water exiting the area has passed).
- Remove sediment buildup in front of BMP.
- Remove BMP (recycle and/or re-use if applicable).
- Re-vegetate area disturbed by BMP removal.



*Straw Bale Barrier (3) being used with a rock spillway decreasing runoff velocity and retaining sediment onsite*



## SEMI-PERVIOUS STRAW BALE SEDIMENT BARRIER

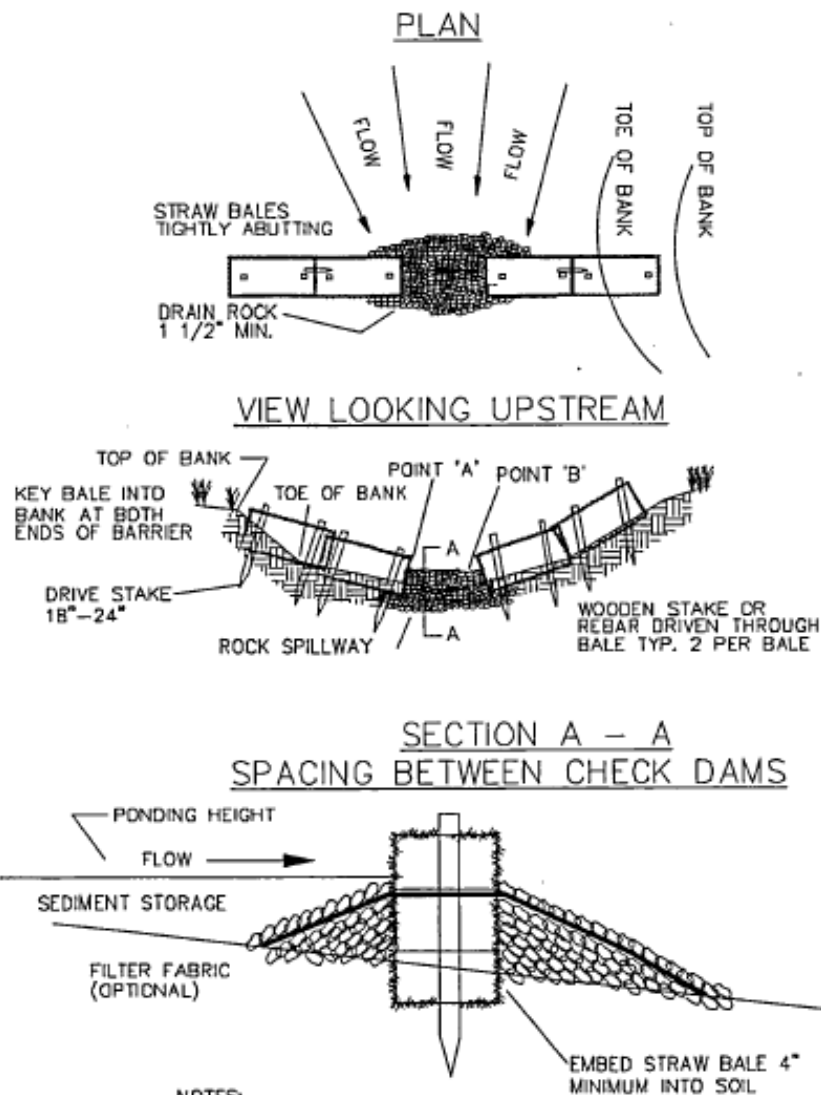

**NOTES:**

1. EMBED BALES 4" INTO THE SOIL AND 'KEY' BALES INTO THE CHANNEL BANKS. PREVENT FLOW AROUND BALES
2. POINT 'A' MUST BE HIGHER THAN POINT 'B' (SPILLWAY HEIGHT).
3. PLACE BALES PERPENDICULAR TO THE FLOW WITH ENDS TIGHTLY ABUTTING
4. SPILLWAY HEIGHT SHALL NOT EXCEED 24".



## **BMP STRAW LOG**

---

### **DESCRIPTION**

**S**traw logs are manufactured from straw (or flax) wrapped in plastic netting. Logs are placed and staked along the contour of newly constructed or disturbed slopes, in shallow trenches. When cut or folded to appropriate length, these logs can be used to provide filter/perimeter protection, settling, reduction in water velocity/erosive forces.

### **PURPOSE**

The purpose of this BMP includes, but is not limited to:

- Reducing slope length to capture and retain sediment on the slope.
- Temporarily stabilizing slopes by reducing soil creep, sheet and rill erosion until permanent vegetation can be established.
- Trapping topsoil and retaining moisture from rainfall, which aids in growth of seedlings planted along the upslope side of the rolls.
- Intercepting and detaining small amounts of water from disturbed areas during construction operations in order to promote settling of soil particles.
- Filtering soil particles and debris.
- Reducing water velocity and erosive forces.

### **APPLICATIONS**

This BMP may be used in ditches or across culvert ends of any dimension. It may be used instead of excelsior filled logs, coir logs, or straw bale filtering systems. Straw logs may also be used for perimeter sediment control. This BMP is particularly useful in areas where the effects of soil disturbance need to be minimized.

This BMP may be used in gullies and stream channels as check dams; in conjunction with gabions, rip rap, articulated block, or cellular confinement systems. It may be used to anchor and enhance the effectiveness of willow wattles (fascines), turf reinforcement mats, coir mats, continuous berms and other erosion control material. Straw logs may be used to replace silt fences or straw bales on steep slopes. It may be used in combination with other BMPs.



---

## LIMITATIONS

This BMP should not be used:

- Where flow volume or water velocity inhibit BMP function.
- For permanent applications. (Other than vegetation).
- When maintenance activities could reduce actual or potential high flow salmonid refuge functions, this BMP will only be used if:
  - Required or allowed by permit conditions.
  - Required by other regulations.

## CONSTRUCTION GUIDELINES

- Logs are placed and staked along the contour of newly constructed or disturbed slopes, in 2-3 inch deep trench.
- Spacing depends on soil type and slope steepness.
- Tightly abut any adjacent logs.
- Install to prevent water from going around or under BMP.
- See "Live Staking", "Handseeding" and/or "Hydroseeding" BMP for planting.

## BMP MAINTENANCE

- During construction, inspect BMPs daily during the workweek. Schedule additional inspections during storm events. Make any required repairs.
- Sediment should be removed when deposits reach one-half the height of the BMP.

## BMP REMOVAL

- Evaluate site to determine BMP is no longer needed (the area has stabilized—potential of sediment laden water exiting the area has passed).
- Remove sediment buildup in front of BMP.
- Depending upon BMP placement, re-vegetation of site may be necessary.
- BMP removal may not be necessary.



BMP: STRAW LOG (continued)

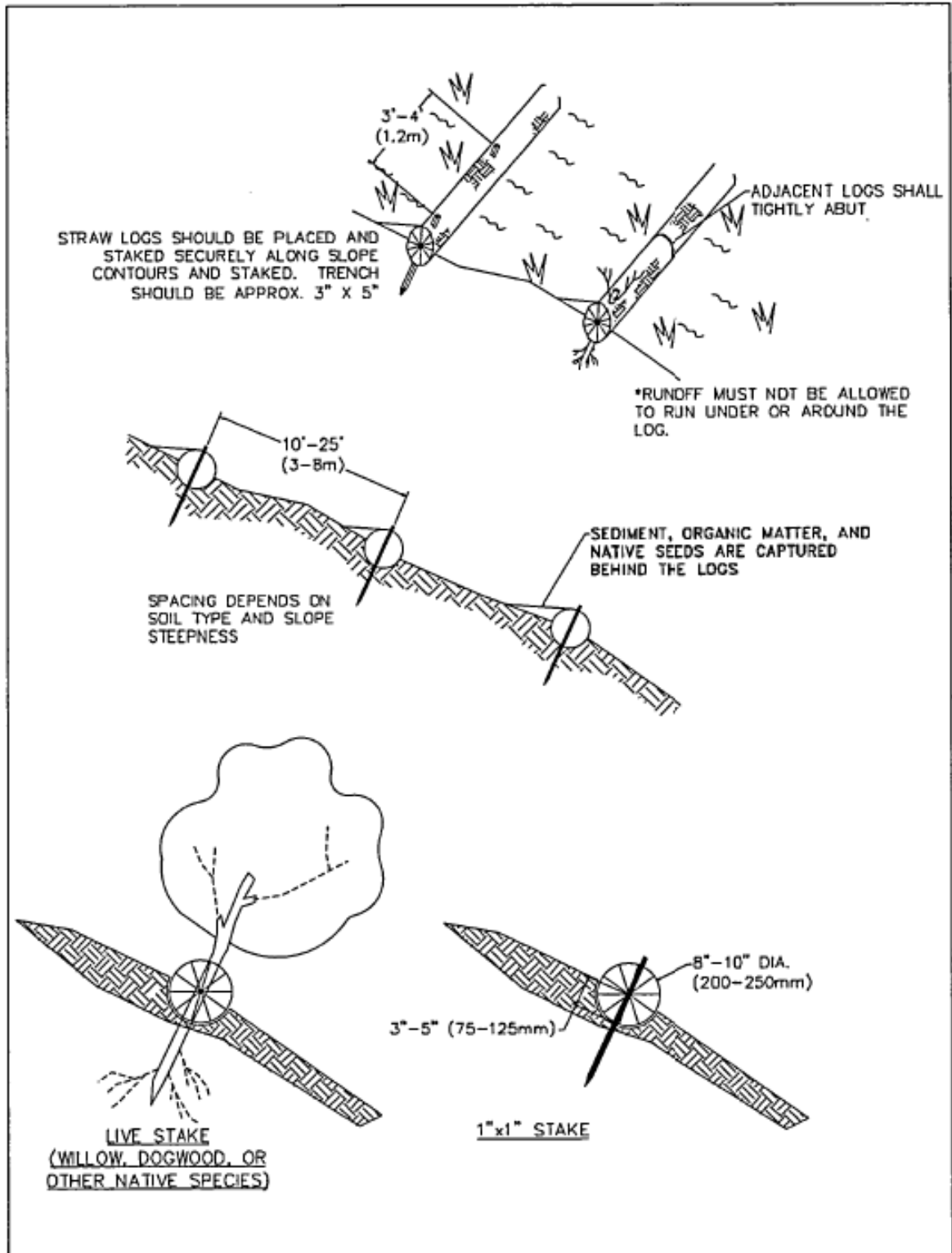

# Stream Bank Stabilization - Bioengineering

## **BMP** **STREAM BANK STABILIZATION** **(BIO-ENGINEERING)**



---

### **DESCRIPTION**

This BMP utilizes vegetation as a method of stabilizing stream banks. Use of stream bank stabilization requires design. For example: see DOE, WSDFW, and/or King County Bank Stabilization Guidelines.

### **PURPOSE**

The purpose of this BMP includes, but is not limited to:

- Protecting stream banks from the erosive forces of flowing water, thereby, reducing silts and sedimentation.
- Using it in conjunction with other practices to provide for an increase in site stability.
- Providing habitat and shade when planted along stream and/or watercourse banks.
- Providing habitat for primary production.
- Providing habitat for prey base organisms such as macro-invertebrates.



*Stabilizing the stream bank by using coir logs, hydroseeding, and live staking.  
Streambed gravel installed to provide a natural spawning substrate*



## **BMP STREAM BYPASS**

---

### **DESCRIPTION**

A stream bypass is a method of diverting the main flow of a stream to a temporary alternate route during construction. It is used in conjunction with a cofferdam and pumps. A stream bypass may be constructed by various methods or combination of methods such as earthen berms, sand bags, ecology blocks and aqua barriers.

### **PURPOSE**

The purpose of this BMP includes, but is not limited to:

- Diverting flowing water away from or around a construction site.
- Minimizing sedimentation.
- In limited cases, it may provide for fish passage.

### **APPLICATIONS**

This BMP may be used at stream crossings during culvert replacement, at bridge repair sites, and other sites where the stream flow cannot be interrupted. It may be used in combination with other barriers.

### **CONSTRUCTION GUIDELINES**

- Stream bypass BMPs must be installed according to applicable permit requirements.
- Refer to Appendix B for Fish Exclusion Protocols.
- Determine best method for specific site.
- Discuss strategy with crew.
- Work quickly to avoid water contamination by sediment.
- Ensure pipe outlet is stabilized to prevent scour and erosion.
- Pump and bypass should be designed or reviewed by an engineer to ensure capacity can handle peak flows.

### **BMP MAINTENANCE**

- Inspect bypass, pump, and dam periodically. Repair any leaks.
- Check for scour at bypass outfall. Repair or move as necessary.
- Have adequate fuel supply and backup pumps in the event of mechanical failure.





- Inspect fish isolation nets to ensure complete exclusion. Remove any accumulated debris from isolation net.

### **BMP REMOVAL**

- Remove BMP when in-water work is complete.
- Remove BMP (recycle and/or re-use if applicable).
- Re-vegetate area disturbed by BMP removal (if applicable).



*A stream bypass used to divert water around a construction site*



BMP: STREAM BYPASS (continued)

---



*A stream bypass used to divert water around a construction site*



*STREAM BYPASS DETAILS*

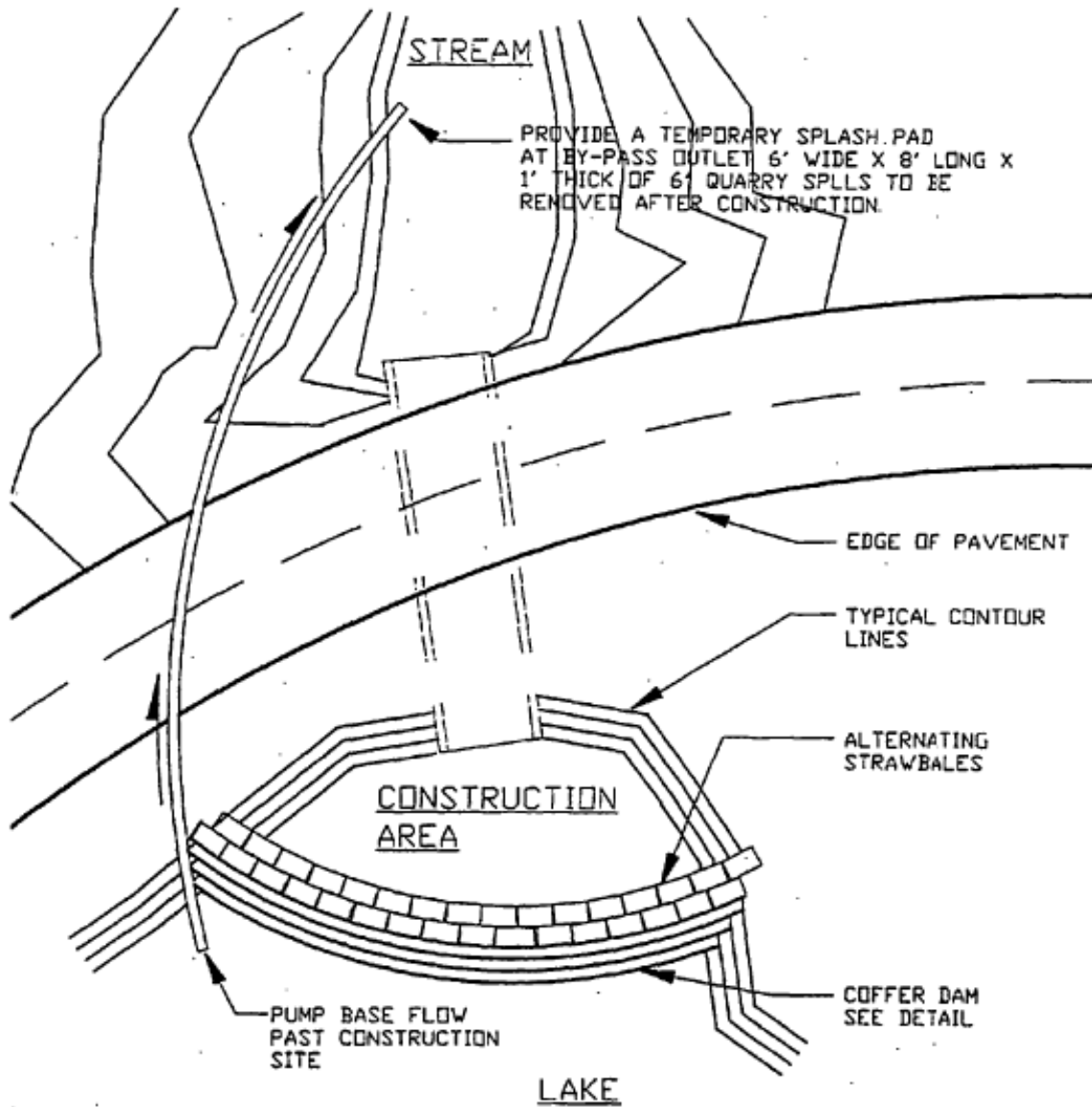



## **BMP STREAMBED GRAVEL**

---

### **DESCRIPTION**

**S**treambed gravel is sediment free, non-angular gravel of variable sizes used for habitat protection/maintenance or culvert replacements (which may be watercourses or streams).

### **PURPOSE**

The purpose of this BMP includes, but is not limited to:

- Providing a natural substrate.
- Minimizing siltation in ditches and/or stormwater facilities.

### **APPLICATIONS**

This BMP may be used to provide fish habitat in sensitive areas, culverts or ditches used by fish. It may be used in combination with other BMPs.

### **LIMITATIONS**

This BMP should not be used:

- If the gravel does not meet design specifications.

### **CONSTRUCTION GUIDELINES**

- Streambed gravel must be placed in accordance with applicable design and/or permit conditions.
- Check gravel gradation to ensure it meets design specifications.
- If gravel does not meet specifications because of excessive fines, wash rock off-site (at a location where washed water can not enter watercourses, streams or wetlands) until water runs clear.
- Haul material in clean truck bed.
- Dump cleaned rock onto tarped area on-site.
- Place a cover and berm around clean rock stockpiles.

### **BMP MAINTENANCE**

- Inspect piles of cleaned rock periodically. If rock becomes sediment-laden re-wash rock prior to use.

### **BMP REMOVAL**

- BMP removal is not applicable.



*Placing streambed gravel inside a newly installed cross culvert to provide a natural substrate for fish*



## **BMP** **SURFACE ROUGHENING**

---

### **DESCRIPTION**

**S**urface roughening is roughening a bare, sloped soil surface with horizontal grooves running across the slope. Grooves can be large-scale, such as grooving with disks, tiller, or other machinery, or with heavy track machinery which should be reserved for sandy, noncompressible soils. Roughening aids the establishment of vegetative cover, improves water infiltration, and decreases runoff velocity. This BMP is intended to keep soil from becoming water borne and reduces water velocity/erosive forces.

### **PURPOSE**

The purpose of this BMP includes, but is not limited to:

- Reducing runoff velocity and increasing infiltration.
- Reducing erosion and providing for sediment trapping.
- Aiding in establishment of vegetative cover with seed.
- Reducing wind velocity at the soil surface.

### **APPLICATIONS**

This BMP should be used as a temporary technique. It may be used in areas to reduce surface runoff or wind velocity until other BMPs can be installed. This BMP may be used on steeper slopes where revegetation is establishing. This BMP may be used in combination with other BMPs.

### **LIMITATIONS**

This BMP should not be used:

- On slopes with a rock surface.
- On excessively roughened slopes where mowing is planned.
- In sensitive areas with hydric soils, due to heavy compaction.
- On steep slopes without simultaneous revegetation.

### **CONSTRUCTION GUIDELINES**

- Surface roughening shall be done by operating tracked equipment up and down the slope to leave traverse depressions in the soil.
  - As few passes as possible should be made to minimize soil compaction.
-



- 
- The surface should be roughened to a depth of 2 to 4 inches.

#### **BMP MAINTENANCE**

- During construction, inspect BMPs daily during the workweek. Schedule additional inspections during storm events. Check for erosion, scour and sloughing, make any required repairs.

#### **BMP REMOVAL**

- BMP removal is not applicable.



## SURFACE ROUGHENING

### TRACKING

TRACKING WITH MACHINERY UP AND DOWN THE SLOPE PROVIDES GROOVES THAT WILL CATCH SEED RAINFALL AND REDUCE RUNOFF

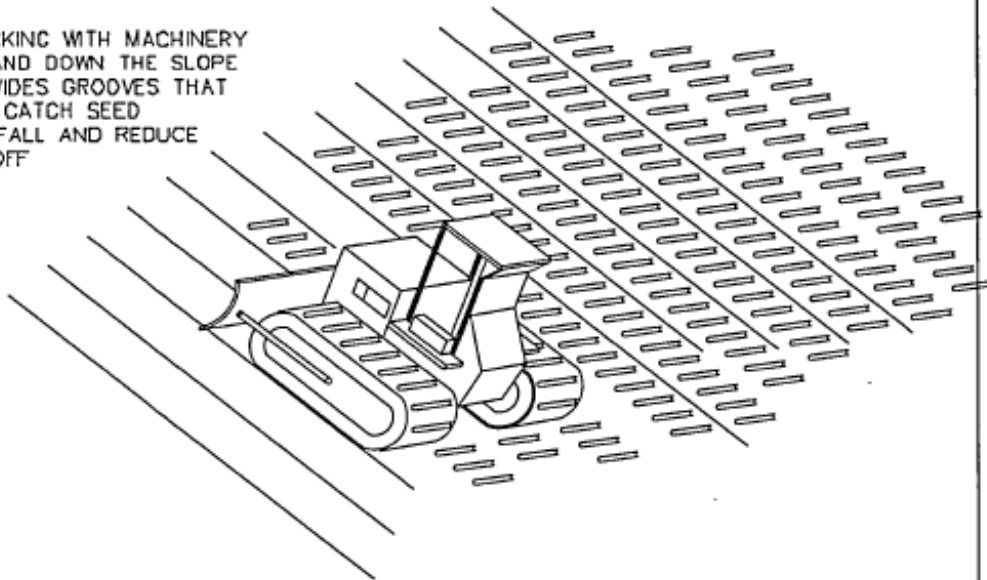

### CONTOUR FURROWS

GROOVES WILL CATCH SEED, FERTILIZER, MULCH, RAINFALL, AND DECREASE RUNOFF.

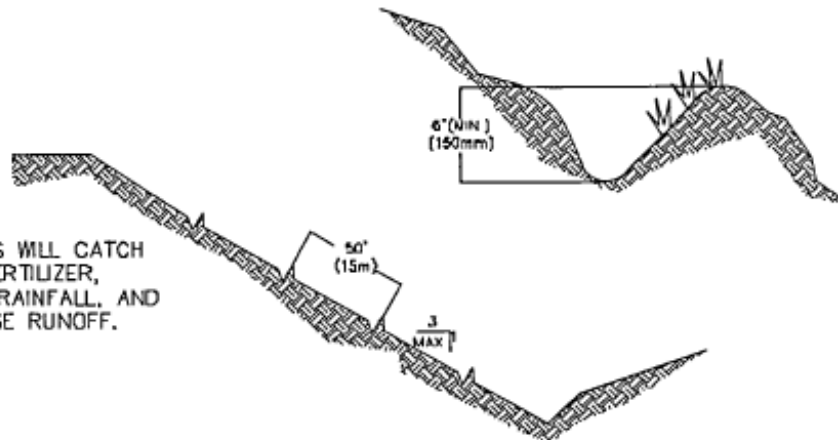





TRACKING

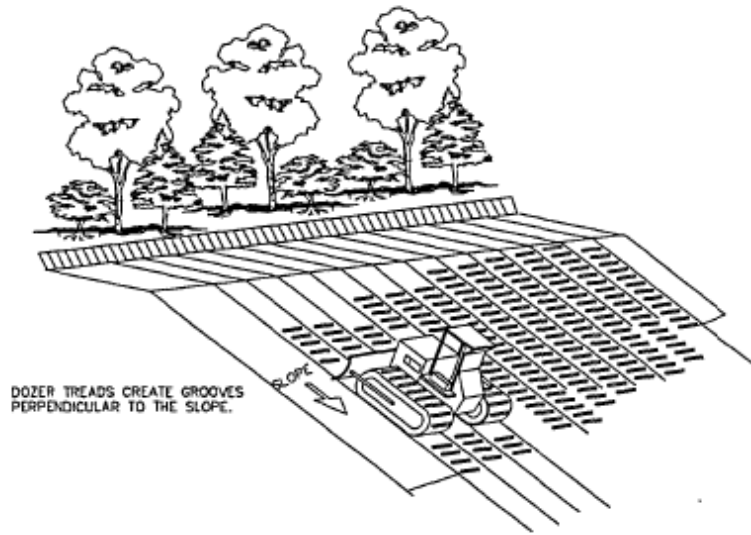

DOZER TREADS CREATE GROOVES PERPENDICULAR TO THE SLOPE.

FILL SLOPE TREATMENT

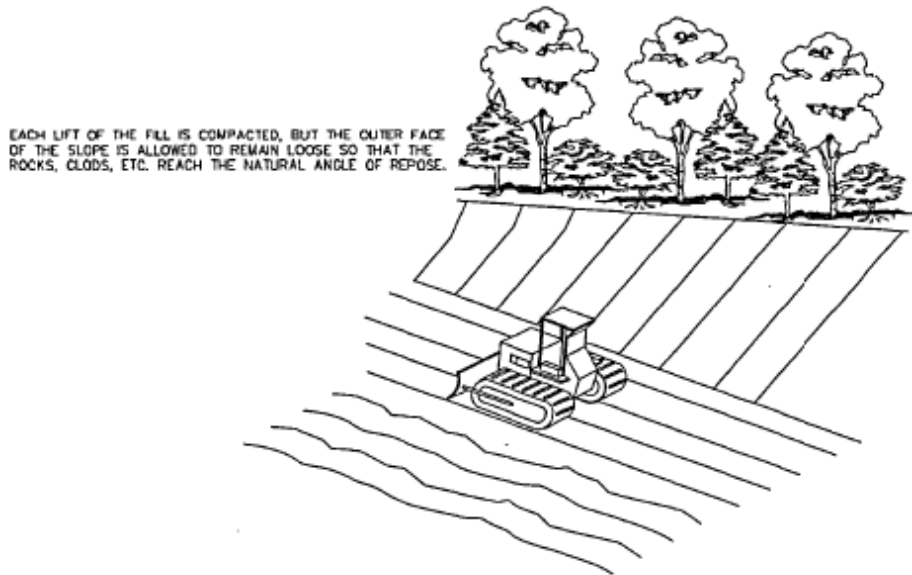

EACH LIFT OF THE FILL IS COMPACTED, BUT THE OUTER FACE OF THE SLOPE IS ALLOWED TO REMAIN LOOSE SO THAT THE ROCKS, CLODS, ETC. REACH THE NATURAL ANGLE OF REPOSE.



## **BMP SWEEPING**

---

### **DESCRIPTION**

**S**weeping is done by hand or mechanical means. A sweeper is a vehicle with brushes and/or a vacuum system and a water spray system used on the roadways to remove debris and soil particles.

### **PURPOSE**

The purpose of this BMP includes, but is not limited to:

- Removing soil particles and debris before entering drainage systems, streams or watercourses.
- Suppressing dust on roadways and at construction sites.
- Removal of snow sand after snow and ice control operations.

### **APPLICATIONS**

This BMP may be used to remove soil particles, debris and/or snow sand from paved surfaces. It may be used in combination with other BMPs.

### **LIMITATIONS**

- All street sweeping is a benefit. There are no limitations.

### **CONSTRUCTION GUIDELINES**

- Use pickup brooms in sensitive areas.
- Always use water with mechanical brooms.
- Schedule snow sand removal as part of the snow and ice emergency response.
- Dispose of collected material.

### **BMP MAINTENANCE**

- BMP maintenance is not applicable.

### **BMP REMOVAL**

- BMP removal is not applicable.
-



*A sweeper picking up debris and soil particles on a paved access road*

# Temporary Sediment Trap

## **BMP TEMPORARY SEDIMENT TRAP**



---

### **DESCRIPTION**

**A** temporary sediment trap is a small ponding area formed by constructing an earthen embankment with a rock outlet to allow for soil particle settling.

### **PURPOSE**

The purpose of this BMP includes, but is not limited to:

- Intercepting and detaining small amounts of water from disturbed areas during construction operations in order to allow settling of soil particles.
- Retaining sediment on site.

### **APPLICATIONS**

This BMP may be used below disturbed areas where the total contributing drainage area is less than 3 acres. It may also be used where the sediment trap will be used no longer than 18 months. This BMP may be used in combination with other BMPs.

### **LIMITATIONS**

This BMP should not be used:

- In areas where the total contributing drainage area is more than 3 acres.

### **CONSTRUCTION GUIDELINES**

- The area under the embankment shall be cleared and stripped of any vegetation and root mat.
- Fill material shall be free of roots or other woody vegetation, organic material and other unsuitable material.
- All embankment slopes shall be not steeper than 2 horizontal to 1 vertical.
- The embankment shall be seeded.

### **BMP MAINTENANCE**

- During construction, inspect BMPs daily during the workweek. Schedule additional inspections during storm events. Make any required repairs.



BMP: TEMPORARY SEDIMENT TRAP (continued)

---

- Sediment shall be removed when it has accumulated to one-half the original dimension.

**BMP REMOVAL**

- Evaluate site to determine BMP is no longer needed (the area has stabilized—potential of sediment laden water exiting the area has passed).
- Remove sediment buildup from BMP.
- Remove BMP (recycle and/or re-use if applicable).
- Re-vegetate area disturbed by BMP removal (if applicable).



BMP: TEMPORARY SEDIMENT TRAP (continued)

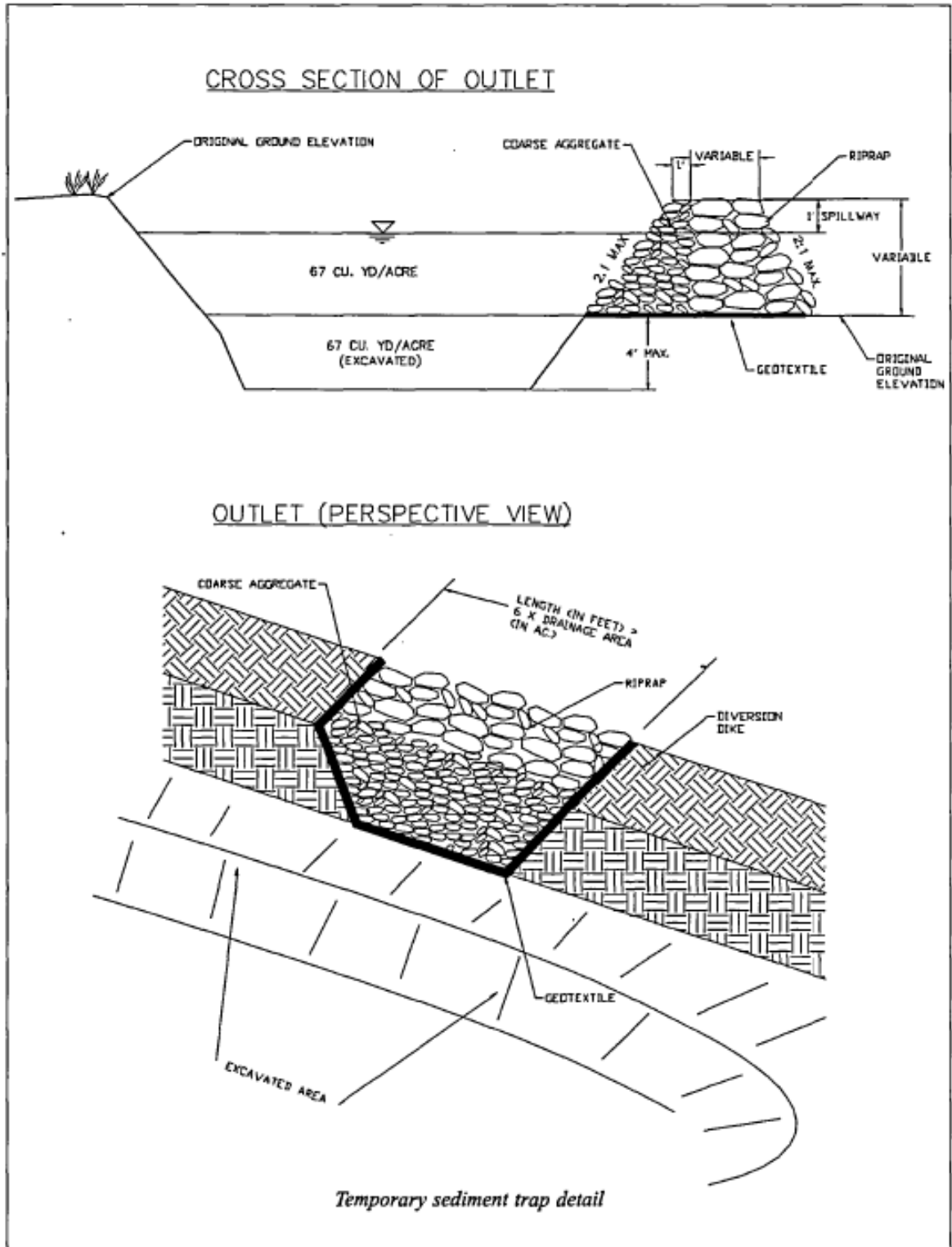



## **BMP TRIANGULAR SILT DIKE**

---

### **DESCRIPTION**

**A** triangular silt dike is a sediment control device made of foam sewn into a woven geo-synthetic fabric. It is triangular in shape, 10 in. to 14 in. high in the center, with a 20 in. to 28 in. base. An apron extends beyond both sides of the triangle along its standard section of 7 ft. A sleeve at one end allows attachment of additional sections as needed. This BMP can be used to provide settling and/or reduction in water velocity/erosive forces.

### **PURPOSE**

The purpose of this BMP includes, but is not limited to:

- Intercepting sheet flow.
- Intercepting and detaining small amounts of water from disturbed areas during construction operations in order to allow settling of soil particles.
- Decreasing down slope sheet flow velocity.
- Retaining soil particles on site.

### **APPLICATIONS**

This BMP may be used for temporary check dams in ditches of any dimension. This BMP may be used for perimeter protection. It may be used in combination with other barriers.

This BMP may be used below disturbed areas subject to sheet and rill erosion where drainage area is no greater than .25 acre per 100 lineal feet of barrier and the slope behind the barrier should be no steeper than 2 horizontal to 1 vertical. On relatively flat slopes the maximum disturbed slope distance should not exceed 100 feet. The allowable disturbed slope distance decreases as the slope gets steeper.

### **LIMITATIONS**

This BMP should not be used:

- Where flow volume or velocity inhibit BMP function.
  - As a filter.
  - When maintenance activities could reduce actual or potential high flow salmonid refuge functions, this BMP will only be used if:
-



- Required or allowed by permit conditions.
- Required by other regulations.

### **CONSTRUCTION GUIDELINES**

- Install with the long flap upstream.
- Install to prevent water from going around or under BMP.
- BMP should be placed along contours.
- BMP must be anchored with adhesive on asphalt or other hard surfaces or staples or stakes on soil or soft surfaces.

### **BMP MAINTENANCE**

- During construction, inspect BMPs daily during the workweek. Schedule additional inspections during storm events. Make any required repairs.
- Sediment should be removed when deposits reach one-half the height of the BMP.

### **BMP REMOVAL**

- Evaluate site to determine BMP is no longer needed (the area has stabilized—potential of sediment laden water exiting the area has passed).
- Remove sediment buildup in front of BMP.
- Remove BMP (recycle and/or re-use if applicable).
- Use sweeper or hand broom to clean road surface.
- Depending upon BMP placement, re-vegetation of site may be necessary.





BMP: TRIANGULAR SILT DIKE (continued)

---



*A triangular silt dike detaining water and allowing soil particles to settle*



*A triangular silt dike in place with accumulated sediment being retained on site, prior to cleaning*

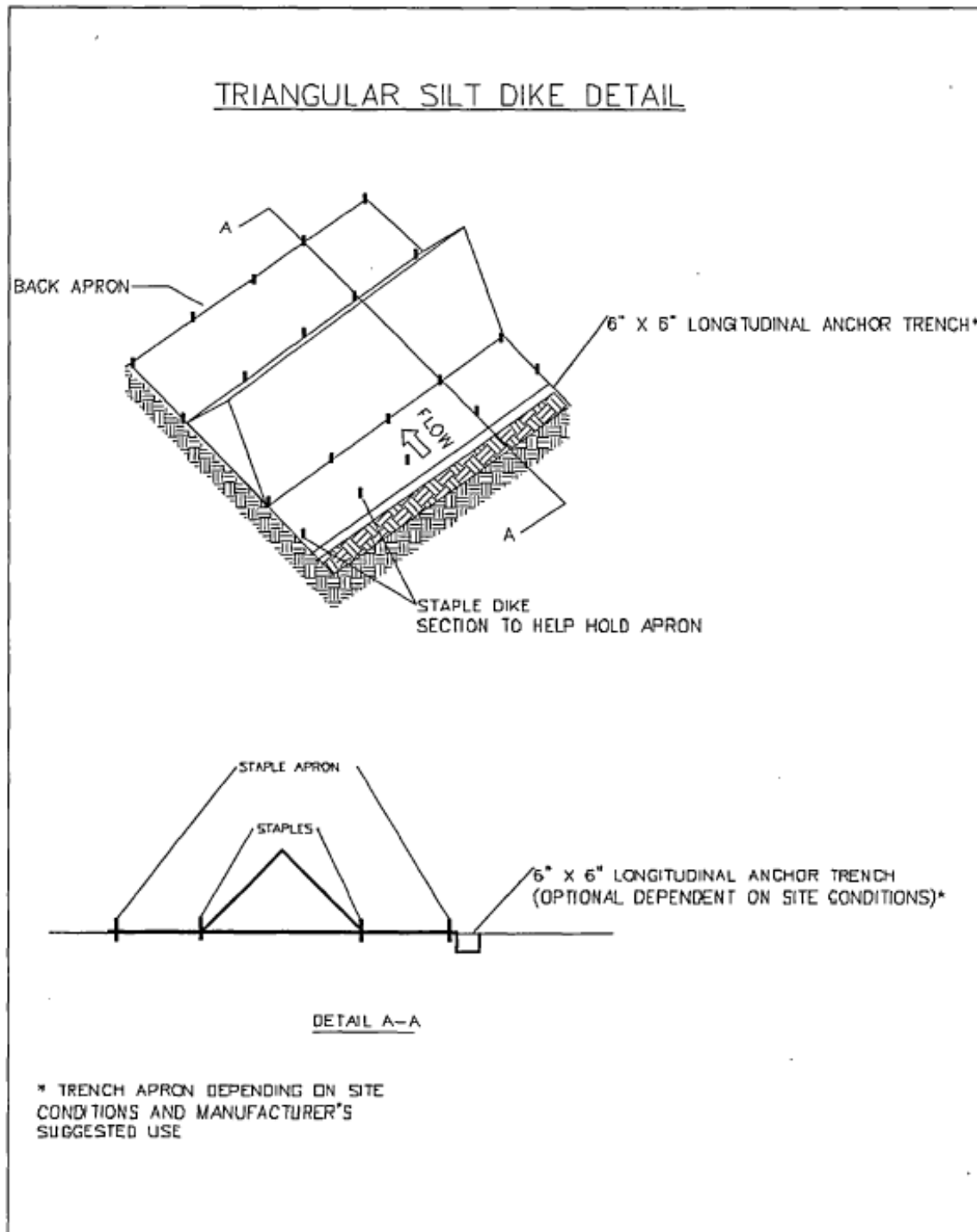



## **BMP TURBIDITY CURTAIN**

---

### **DESCRIPTION**

**A** turbidity curtain is a pre-manufactured floating geotextile structure which minimizes turbidity transport from a disturbed area adjacent to or within a body of water. This device allows for settling of suspended solids and/or reducing water velocity.

### **PURPOSE**

The purpose of this BMP includes, but is not limited to:

- Minimizing the mixing of turbid water with the adjacent clean water.
- Containing soil particles during construction and/or repair activities.

### **APPLICATIONS**

This BMP may be used in water including open drainage systems, non-tidal and tidal watercourses where construction activities create turbidity.

### **LIMITATIONS**

This BMP should not be used:

- Or placed across the main flow of a significant body of water.
- To cross more than 2/3 of the main flow of any salmonids bearing water at the time of the year when any life history stage of salmonids are expected to be present.
- Where flow volume or water velocity inhibit BMP function.

### **CONSTRUCTION GUIDELINES**

- Turbidity curtains must be installed according to applicable permit requirements.
  - Follow manufacturer recommendations and guidelines for installation and safety measures.
  - Turbidity curtains are available in various heights. The units are preassembled in 50-foot lengths and are used by connecting the number of units required.
  - Add a suitable weight or anchoring system to the bottom of the curtain.
  - See drawings on following pages.
-



- The turbidity curtain can be deployed in standing and/or in flowing water (see limitations).

### **BMP MAINTENANCE**

- During construction, inspect BMPs daily during the workweek. Schedule additional inspections during storm events. Make any required repairs.
- Inspect daily.
- If repairs are required, follow directions in repair kit instructions.

### **BMP REMOVAL**

- Remove BMP (recycle and/or reuse if applicable).
- Follow manufacturer recommendations for removal.
- When curtain is removed it shall be in such a manner as to minimize turbidity. Remaining soil particles shall be sufficiently settled before removing the curtain.
- Water discharged from turbidity curtain shall meet permit requirements at the point of discharge.



*A river repair project in progress using a turbidity curtain to contain turbid water*



BMP: TURBIDITY CURTAIN (continued)

TURBIDITY CURTAIN TYPE III

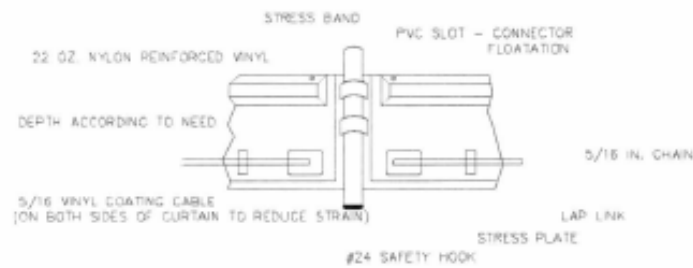

NOTE: ANCHORING WITH BUOYS, AS SHOWN, REMOVES ALL VERTICAL FORCES FROM THE CURTAIN. HENCE, THE CURTAIN WILL NOT SINK FROM WIND OR CURRENT LOADS.

ORIENTATION WHEN INSTALLED  
(TIDAL SITUATION - TYPE III)

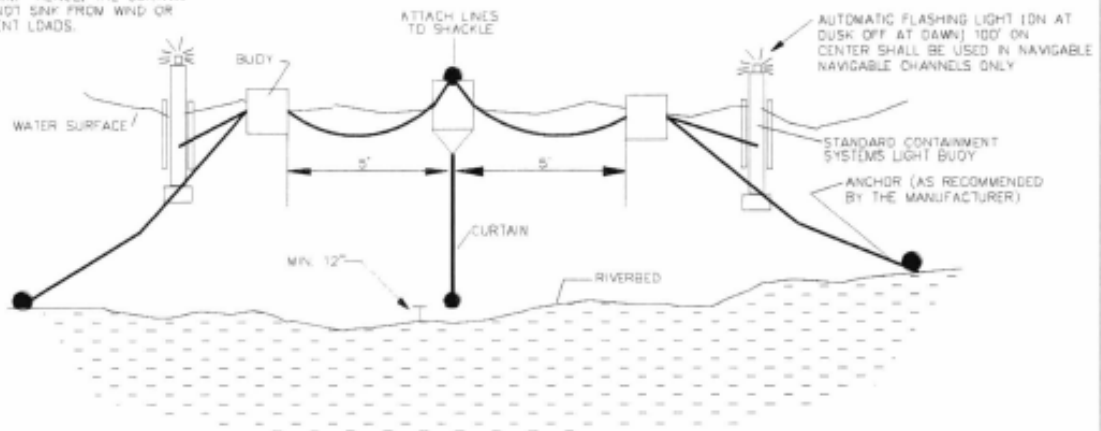

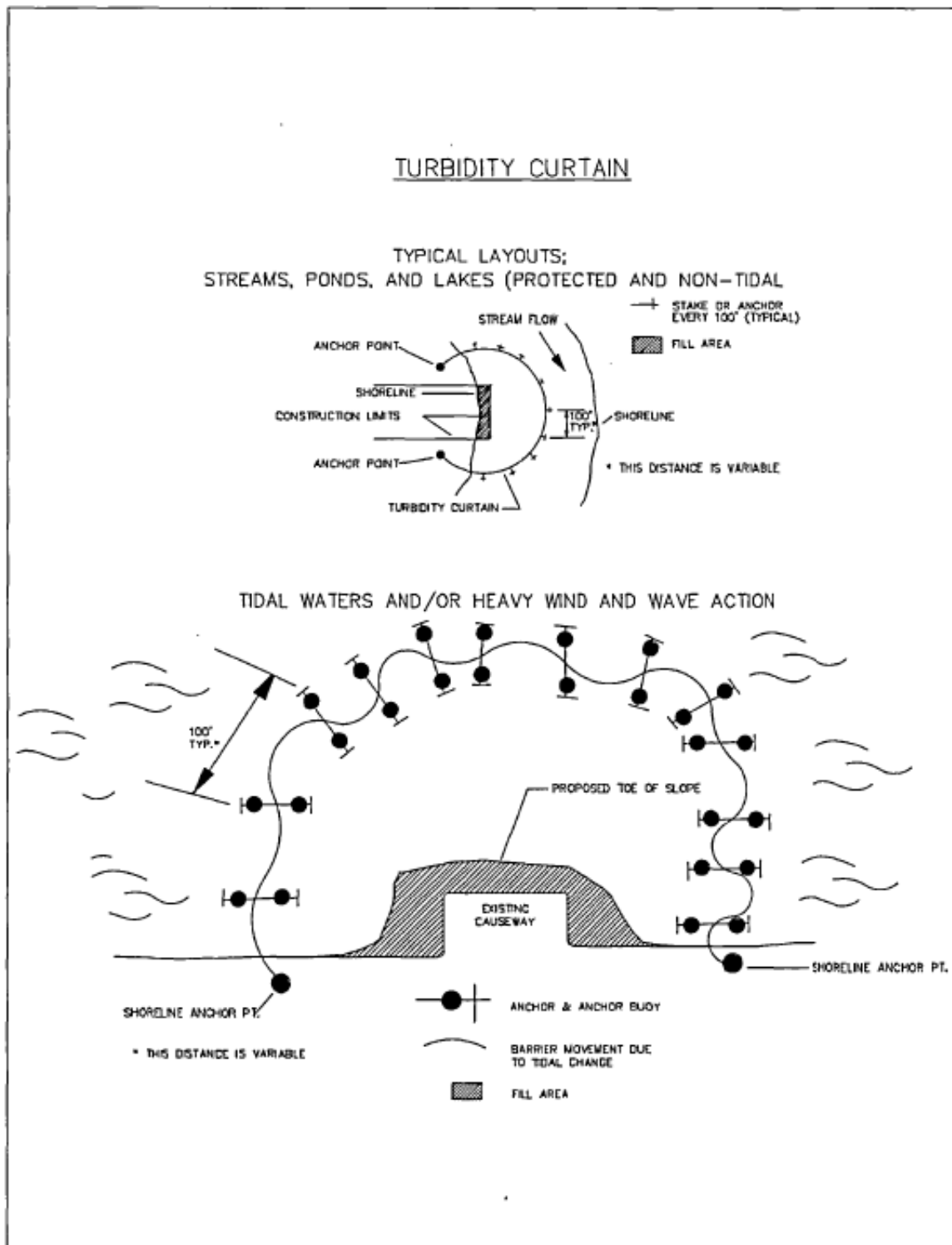



## **BMP VACTORING**

---

### **DESCRIPTION**

**V**actoring is the use of a truck mounted drainage system cleaning device. The cleaning device operates on the principle of large volume, high-speed air movement to lift water, soil particles/sediment, contaminants and debris. A large tube conveys the collected materials into a tank mounted on the truck. The cleaning device also includes a freshwater supply and high-pressure pump system to flush and clean pipes and structures. Collected material is transported in the truck to approved disposal sites.

### **PURPOSE**

The purpose of this BMP includes, but is not limited to:

- Cleaning drainage systems.
- Dewatering the work area.

### **APPLICATIONS**

This BMP may be used to clean and/or dewater enclosed drainage systems, open drainage systems, excavations and settling ponds. It may be used in conjunction with other BMPs.

### **LIMITATIONS**

This BMP should not be used:

- Where the flow exceeds the capacity of the cleaning device.
- To remove large debris.

### **CONSTRUCTION GUIDELINES**

- When used in a watercourse or stream, vactoring should be done according to applicable permit requirements.
- Reduce potential for sediments and debris from re-entering water.
- If entering a confined space use appropriate air testing and entry procedures.
- Prepare work sequence to address backup equipment or project phasing when tank is full.



---

## **BMP MAINTENANCE**

- Follow manufacturer's operation and service guidelines.

## **BMP REMOVAL**

- BMP removal is not applicable.



*Vactor truck removing sediment from catch basin*





## **BMP VEGETATIVE BUFFER**

---

### **DESCRIPTION**

A vegetative buffer is a strip of vegetation (grasses and small forbes) adjacent to shoulders, ditches, pavement, and/or gravel roads. This BMP reduces soil from becoming water borne and reduces water velocity/erosive forces.

### **PURPOSE**

The purpose of the BMP includes, but is not limited to:

- Providing bio-filtration.
- Reducing soil particles, snow sand and debris from entering ditches or the drainage system.
- Providing habitat and shade when planted along stream and/or watercourse banks.
- Providing habitat for prey base organisms such as macro-invertebrates.
- Allowing plants to grow over the ditch or channel.
- Providing shade as long as it does not become a public safety hazard.

### **APPLICATIONS**

This BMP may be used adjacent to ditches and/or sensitive areas, parallel to roadways, parking lots or at road crossings and must comply with back of slope BMPs along ditch lines. It may be used in combination with other BMPs.

### **LIMITATIONS**

This BMP should not be used:

- If it creates a potential public safety hazard.
- If it could cause water flow problems that may result in flooding of the roadway.

### **CONSTRUCTION GUIDELINES**

- To the greatest extent possible, preserve existing vegetation as a buffer.
- See other BMPs such as, handseeding, hydroseeding and/or live staking for construction guidelines.



### **BMP MAINTENANCE**

- Mow or trim the vegetative buffer in accordance with applicable standards.
- Re-vegetate as necessary.

### **BMP REMOVAL**

- BMP removal is not necessary.



*Using a ditchmaster  
to leave a vegetative  
buffer*

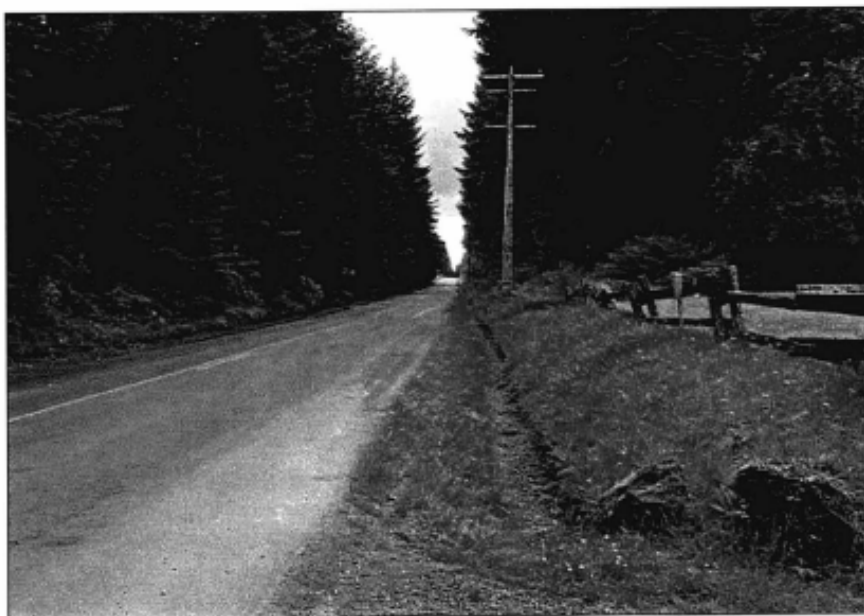

*Roadside ditch with a vegetative buffer*

---



## **BMP WASHED ROCK**

---

### **DESCRIPTION**

**W**ashed rock is sediment free non-angular gravel.

### **PURPOSE**

The purpose of this BMP includes, but is not limited to:

- Minimizing siltation in ditches and/or stormwater facilities.
- Reducing velocity and erosive forces.
- Filtering soil particles from water.
- Stabilizing disturbed areas.

### **APPLICATIONS**

This BMP may be used wherever gravel will be placed in ditches and/or stormwater facilities which are watercourses or streams. It may be used in combination with other BMPs.

### **LIMITATIONS**

This BMP should not be used:

- In locations where design and/or permit conditions prescribe other streambed material.
- On steep slopes.
- On road shoulders.

### **CONSTRUCTION GUIDELINES**

- Wash rock off-site (at a location where washed water can not enter watercourses, streams or wetlands) until water runs clear.
- Haul material in clean truck bed.
- Dump cleaned rock onto tarped area on-site.
- Place cover and berms around clean rock that will not be used immediately.

### **BMP MAINTENANCE**

- Inspect stockpiles of cleaned rock periodically. If rock becomes contaminated rewash rock prior to use.

### **BMP REMOVAL**

- BMP removal is not applicable.

## Absorbent Pads

### BMP

#### Absorbent Pads, Socks, and/or Booms

---

##### DESCRIPTION

Absorbent pads, socks, and/or booms are pre-manufactured materials used to contain or collect hydrocarbon or chemical spills and/or other discharges. Booms are encased in a specially designed outer skin (hydrophobic cloth) that repels water-based substances while allowing the highly absorbent filler material to soak up petroleum products. Socks are smaller and narrower than booms. Pads are rectangular and flat, some float without absorbing water but will still wick in petroleum and related liquids on contact. Others will collect all liquids that they make contact with. Absorbent products are available in several different diameters and lengths.

##### PURPOSE

The purpose of this BMP includes, but is not limited to:

- Collecting and absorbing spills or discharges during construction, operations, maintenance, or repair activities
- Most booms, socks, and pads are designed for oil and other petroleum products for spills in water or on land
- Preventative maintenance to protect during fueling on small equipment

##### APPLICATIONS

This BMP may be used for, but is not limited to:

- In combination with other BMP(s)
- During rain
- During the operation of movable and floating bridges
- During bridge maintenance cleaning and washing
- Across a narrow entrance to a sensitive area
- In places where the absorbent can absorb and/or collect oil
- To detect contaminants around a sensitive area and into containment areas
- As a protective barrier when repairing vehicles or machinery where hydrocarbon spills may happen

##### LIMITATIONS

The limits of the product capacity to pick up and hold liquids depend on the amount of liquid to be controlled. It may require the use of more than one (example: one pad may not be enough, several may need to be used to absorb a spill).

## CONSTRUCTION GUIDELINES

- When used in watercourses or streams, use in accordance with product label
- Booms are constructed with a strong mesh outer skin, which encases highly absorbent polypropylene filler
- Booms are available in a variety of diameters and lengths, which can be connected together using clips on each end, forming barriers of longer containment and absorption
- Use appropriate width and length booms, socks, or pads for the work to be performed
- The characteristics of absorbents and oil absorbent types must be considered when choosing BMPs for collecting, absorbing, and cleaning up spills:
  - The absorption of oil is faster with lighter oil products
  - The thicker oils adhere to the surface of the absorbent more effectively
  - The weight of recovered oil can cause an absorbent structure to sag and deform, and when it is lifted out of the water it can release oil that is trapped in its pores
  - During recovery of absorbent materials, lighter, less viscous oil is lost through pores more easily than are heavier oils, creating a greater potential for secondary contamination
  - Attach booms, socks, or pads securely if required prior to starting work
  - Booms, socks, or pads are available in several different diameters and lengths

## BMP MAINTENANCE

- During construction, operations and maintenance inspect BMPs daily during the work week
- Schedule additional inspections during storm events and make modifications as needed
- Make required repairs as needed
- In the event of damage, any section of a boom can be repaired or replaced

## BMP REMOVAL

- Evaluate site to determine if BMPs are no longer needed
- Replace boom, sock, or pad when it is no longer absorbing the spill or discharge
- Follow manufacturer's recommendations for removal and disposal (recycle and/or reuse if applicable)
- Remove absorbent BMP carefully after work, containing oil or debris
- Dispose of BMPs in accordance with product label

## Bridge Containment System

### BMP

#### Bridge Containment System

---

##### DESCRIPTION

Bridge containment system may consist of drip tarps, filter tarps, drop cloths, flume, bucket, netting or other materials installed below work areas to collect, contain and reduce debris and contaminants falling into water.

##### PURPOSE

The purpose of the BMP includes, but is not limited to:

- Collect, contain, and reduce falling debris (such as: concrete, woodchips, sawdust, slag and metal, bird nests and fecal material, dirt, moss, sediments, rust, paint chips, liquid paint and petroleum products) during maintenance activities

##### APPLICATIONS

This BMP may be implemented during spot painting, structure cleaning, maintenance and repairs. It may be used in combination with other BMPs.

##### LIMITATIONS

This BMP should not be used:

- During periods of high winds that reduce the effectiveness of the BMP
- Limited to weight capacity of work platforms and equipment

##### CONSTRUCTION GUIDELINES

- Use in accordance with rigging requirements
- Secure drip tarps, filter tarps, drop cloths, flume, buckets, netting or other materials prior to starting work
- Take care that drip tarps, filter tarps, drop cloths, flume, buckets, netting or other materials do not enter the water

##### BMP MAINTENANCE

- During construction/maintenance, inspect BMPs daily during the workweek. Schedule additional inspections during storm events. Make required repairs as needed.
- Debris containment systems need to be emptied regularly. Collected debris will be removed and disposed of at a proper location.
- Rips or tears in drip tarps, filter tarps, drop cloths, flume, netting or other materials are to be repaired or replaced as soon as practical.



**BMP REMOVAL**

- Evaluate site to determine if BMPs are no longer needed
- Remove debris on BMP
- Remove BMP (recycle and/or re-use if applicable)
- Inspect after job is complete to make sure tarps, bucket, tools, drapes, or other materials are in good repair for next project

## Bucket Tram

### BMP

#### Bucket Tram

---

##### DESCRIPTION

A bucket tram consists of two steel “I” beams (Tram) placed under a small bridge that support a bucket that rolls along the beams on four dollies. Steel support cross beams are placed between the bridge abutments. The “I” beams that constitute the tram are attached to the cross beams in a manner that allows the bucket to transport material under the bridge with little or no disturbance to the stream channel or riparian zone. The system is manually operated by pushing or pulling the bucket along the “I” beams. The bucket is constructed with a tipping and locking mechanism to allow unloading.

The bucket can be constructed to specifications to hold a variety of materials like sandbags, riprap or other materials as needed. Any and all parts of this BMP that are newly constructed should be reviewed by a licensed engineer to ensure that the system is safe.

##### PURPOSE

The purpose of this BMP includes, but is not limited to:

- Providing access to the underside of a bridge
- Reduces the need to operate equipment within watercourses and streams
- Allows materials and other BMPs access to work site
- Reduces the need to build an access road thereby reducing erosion and sedimentation
- Reduces disturbance of riparian vegetation
- Provides a safe way to transport materials

##### APPLICATIONS

This BMP may be used anywhere that access is restricted, difficult, or dangerous.

##### LIMITATIONS

This BMP should not be used:

- As the sole BMP
- Without agency Bridge owners permission and approval



### CONSTRUCTION GUIDELINES

- When used in watercourses or streams, this BMP must be used in accordance with permit requirements
- Agency Bridge Preservation Office and or Bridge Maintenance Engineer/Superintendent must be notified to review installation to ensure the integrity of the bridge structure is not jeopardized

### BMP MAINTENANCE

- Operator is present at all times
- Make required repairs as needed

### BMP REMOVAL

- Evaluate site to determine if BMPs are no longer needed
- Inspect after work is completed to make sure equipment is in good repair for next use



*Bucket tram used to transport rip rap for a bridge scour repair.*

## Carbon Dioxide for Cement Leachate

### BMP

### Carbon Dioxide (CO<sub>2</sub>) for Cement Leachate pH Control

---



#### DESCRIPTION

Uncured cement or concrete is highly alkaline. Carbon dioxide is a compressed gas that forms a weakly acidic solution when bubbled through water. This weak acid can be used to counteract the alkalinity of runoff from cured or uncured cement or concrete before it can raise the pH in receiving waters. Equipment required includes a compressed CO<sub>2</sub> cylinder, regulator, hose, gas diffuser (soaker hose or equivalent) and pH and dissolved oxygen meters.

## PURPOSE

- Protect the pH of streams or wetlands at sites where cement or concrete placement or repair work is occurring
- To guard against accidental discharge of alkaline this BMP should be used only as an emergency response to accidental discharges

## APPLICATIONS

This BMP should be available for use when there is a risk of cement or concrete contamination of streams or wetlands. This includes the pouring of fresh cement, such as in bridge/culvert footing repairs, in streams or wetlands. It may be used in conjunction with other BMPs such as a cofferdam or temporary settling pond to provide a reservoir for treatment of water prior to discharge into a stream or wetland.

## LIMITATIONS

- Do not use if the pH is below 7.5.
- The effectiveness of this BMP will decrease as flow rates increase. Other BMP methods to minimize both the volume and the discharge rate of contaminated water should be implemented in conjunction with this BMP.

## CONSTRUCTION GUIDELINES

- Follow manufacturer's recommendations and safety procedures when transporting or using compressed gasses.
- All applicable regulations regarding the transport and use of compressed gas cylinders should be adhered to. If in doubt, contact Washington Department of Labor and Industries at 1-800-547-8367, or <http://www.lni.wa.gov>.
- Where possible, use a settling pond or cofferdam in a manner that will collect any runoff from the work site prior to discharge into the receiving water.
- Completely submerge the soaker hose in the settling pond. Weigh down the hose with small rocks as necessary.
- Monitor the pH of the settling pond. If the pH exceeds background conditions by more than 1.0 pH units, open the valves and bubble CO<sub>2</sub> through the water column at 20 pounds per square inch (psi) outlet pressure.
- Continue to monitor the pH. If the pH does not fall, increase the pressure in the outlet hose. Cease bubbling CO<sub>2</sub> when the pH drops below 7.5. Do not allow the pH to drop below 6.5.

**BMP MAINTENANCE**

- Check CO<sub>2</sub> pressure in the cylinder at regular intervals. Record the pressure drop rate and order a replacement tank as necessary.

**BMP REMOVAL**

- Evaluate site to determine if BMPs are no longer needed

## Divers

### BMP

#### Divers

---

#### DESCRIPTION

This BMP consists of Occupational Safety and Health Administration (OSHA) qualified divers that perform underwater work including qualified underwater bridge inspectors.

#### PURPOSE

The purpose of this BMP includes, but is not limited to:

- Underwater bridge or other structure inspections. Includes nondestructive testing, timber pile analysis and performing scour surveys.
- Underwater bridge repair, rehabilitation and replacement parts such as floating bridge anchor cables. Rehabilitate mechanical and electrical operating systems on movable bridges, or other structures.
- Trash/debris removal.

#### APPLICATIONS

This BMP is used for the repair of bridges, pipelines, piers, and other structures; debris or sediment removal; and other under water maintenance. Also maybe used in maintenance activities such as emergency scour repair and structural analysis. It may be used in combination with other BMPs.

#### LIMITATIONS

This BMP should not be used:

- During periods of high winds/storm events or extreme currents that reduce the effectiveness of the BMP or jeopardizes the safety of the diver
- When OSHA regulations cannot be met



### **CONSTRUCTION GUIDELINES**

- Underwater inspectors shall meet the requirements of 29 CFR Part 1910, and are experienced in inspecting submerged structures in adverse conditions, including limited visibility and strong currents.
- Registered Professional Engineer divers perform and supervise underwater inspections. All inspection divers must qualify as a bridge inspector per 29 CFR part 650. Inspection divers also possess a Level I certification in non-destructive testing and have completed specialized courses in underwater bridge inspection.
- Diving must comply with the requirements established in Chapter 296-37 WAC, Safety Standards for Commercial Diving Operations.
- Repairs, rehabilitation and replacement parts including debris removal in watercourses or streams, use in accordance with permit requirements.

### **BMP MAINTENANCE**

- Crews are to provide progressive clean up of debris during the course of work
- Crews are to implement the appropriate measures for storage and use of materials and equipment

### **BMP REMOVAL**

- Evaluate site to determine if BMPs are no longer needed

## Drain Cover

### BMP

## Drain Cover

---

### DESCRIPTION

A drain cover is used to cover a drain grate by creating a seal around a drain to reduce or prevent liquids such as oil and/or other contaminants from entering the drain as part of the containment process. Drain covers may have a tack surface, a magnetic surface, or be placed under the grate to reduce or prevent flow to the drain.

### PURPOSE

The purpose of this BMP includes, but is not limited to providing a protective barrier that helps to close off surface drains from stormwater, hazardous spills and/or other contaminants until containment and clean up can be performed.

### APPLICATIONS

- This BMP may be used as a protective cover for drains, catch basins and/or manholes for reducing or preventing flows, or responding to a spill. A drain cover is a BMP that may be used in conjunction with other containment BMPs.
- This BMP may be used as a preventive measure in work sites where liquid fueling of equipment may occur.

### LIMITATIONS

This BMP should not be used:

- If site-specific conditions may put employee at risk.

### CONSTRUCTION GUIDELINES

- Follow manufacturer's guidelines for application, installation, and chemical compatibility list.
- Remove build up of material like sediment, stones, branches and other debris from drain inlet area to be covered prior to installation.
- Check drain cover for seal.

### BMP MAINTENANCE

- Check drain cover for seal leaks.
- Check drain cover for cuts or damage to the cover material.

### **BMP REMOVAL**

- Remove BMP when activities are completed and clean up, if needed, has been completed.
- Remove BMP when it is no longer needed
- Remove BMP (recycle and/or re-use if applicable, see manufacturer's guidelines).



## Fiber Rolls

### BMP

## Fiber Rolls

---

### DESCRIPTION

A fiber roll consists of biodegradable geotextile mat/blankets (excelsior, straw or coconut fibers) that is rolled or bound into a tight tubular roll and placed on the toe and face of slopes to intercept runoff, reduce flow velocity, release runoff as sheet flow, or remove sediment from runoff. Fiber rolls may also be used for inlet protection or as check dams. The roll may be cut to the appropriate length, to fit the desired location.

### PURPOSE

The purpose of this BMP includes, but is not limited to:

- Reducing erosion
- Promoting sheet flow
- Reducing down slope sheet flow velocity
- Reducing and detaining soil particles from disturbed areas during construction operation in order to allow settling of soil particles
- Retaining soil particles and debris
- Changing sheet flow direction

### APPLICATIONS

This BMP may be used:

- Along the toe, top, face, and at grade breaks of exposed and erosion prone slopes to shorten slope length and spread runoff as sheet flow
- Below the toe of exposed and erosion prone slopes and may be incorporated with vegetative planting
- As check dams in ditches
- As temporary interceptor dikes or swales
- For drain inlet protection
- Down-slope of exposed soil areas
- Around temporary stockpiles
- Along the perimeter of a work site
- In combination with other BMPs

## LIMITATIONS

This BMP should not be used:

- Where flow volume or velocity inhibit BMP function
- When maintenance activities could reduce access to actual or potential high flow salmonid refuge habitat
- Fiber rolls may be used for drainage inlet protection if they can be properly anchored
- Difficult to move once saturated
- Fiber rolls could be transported by high flows if not properly staked or trenched in
- Fiber rolls have limited sediment capture zone
- Do not use fiber rolls on slopes subject to creep, slumping, or landslide

## CONSTRUCTION GUIDELINES

- When used in watercourses or streams, use in accordance with permit requirements.
- Fiber rolls are rolled tubes of erosion control blanket that can be cut to length for site specific conditions.
- Install to reduce water from going around or under BMP.
- BMP is to be staked (wood only) into the ground or a trench to improve soil particle containment.
- Wooden stakes are normally placed 6" from the end and spaced about 4' or less leaving 1-2" of stake exposed. Alternatively, stakes may be placed on each side of roll tying across with a natural fiber twine or staking in a crossing manner ensuring direct soil contact at all times.
- If more than one fiber roll is placed in a row, the rolls shall be stacked on top of each other, not side by side abutted to each other.
- Wood stakes may be replaced with vegetation whips if rolls can be left on site.

## BMP MAINTENANCE

- During construction, inspect BMPs daily during the workweek. Schedule additional inspection during storm events. Make any required repairs.
- Repair or replace split, torn, unraveling, or slumping fiber rolls.
- Sediment should be removed when deposits reach one-half the height of the BMP.

### **BMP REMOVAL**

- Review site to determine if BMPs are no longer needed (the area has stabilized – potential of sediment laden water exiting the area has passed)
- Remove sediment buildup in front of BMP
- Depending upon BMP placement, re-vegetation of site may be necessary
- BMP removal may not be necessary

## Flushing

### BMP

### Flushing

---

#### DESCRIPTION

Flushing is the use of water under pressure from a street flushing truck or a vactor type truck that is used to flush the street surface or interior of a drainage system to move soil, debris, or other buildup to a desired location.

#### PURPOSE

The purpose of this BMP includes, but is not limited to:

- Flushing of enclosed drainage systems with water to suspend and remove deposited materials
- Flushing the surface of the road to move material over to the side of the road to be picked up with a sweeper
- Street surface cleaning to flush soils and gravel onto the shoulder
- Used to water vegetation as needed

#### APPLICATIONS

Includes but is not limited to:

- Flushing enclosed drainage systems
- Flushing road surface
- Street cleaning
- Sidewalk cleaning
- Island cleaning
- Underpass cleaning

#### LIMITATIONS

This BMP should not be used:

- Where the flow exceeds the capacity of the cleaning device

### **CONSTRUCTION GUIDELINES**

- When used in a watercourse or stream, flushing should be done according to applicable permit requirements
- Reduce potential for sediment and debris from entering surface water
- Flushing is normally used for pipes smaller than 36 inches in diameter
- A water source is necessary for cleaning
- If entering a confined space use appropriate confined space entry requirement.
- De-chlorinate water before flushing

### **BMP MAINTENANCE**

- Check for leaks in tank, hoses, or shoe
- Make repairs as needed

### **BMP REMOVAL**

- BMP removal is not applicable

## Gravel Washing

### BMP

## Gravel Washing

---

### DESCRIPTION

Gravel washing is a method to prepare gravel to reduce fine sediment discharge and to help retain surface flows when new streambed gravel is placed in a channel or culvert. Once placed, the new gravel is gently washed with a small amount of stream water or non-chlorinated water to encourage fines to migrate down into the interstitial spaces of the new gravel.

### PURPOSE

Gravel washing is used to reduce fine sediment discharge and to help seal new streambed gravel to support surface flows during construction of stream channels and/or culvert replacements where streambed gravel is installed.

### APPLICATIONS

This BMP may be used in maintenance activities when new streambed gravel is placed in a channel or culvert, including but not limited to:

- Fish passage
- Fish ladders
- Culvert replacement
- Streambed repair

### LIMITATIONS

- Do not use water that has not been de-chlorinated before using with this BMP
- Do not dewater downstream reaches if stream flow is used to wash new gravel

### CONSTRUCTION GUIDELINES

- May be used in conjunction with other BMPs, like cofferdams, stream bypass and settling tanks and/or vegetated buffer filters.
- After stream gravel is installed, wet down gravel until site is saturated. The source of water may be the stream when using a pump or by partial disassembly of cofferdam.
- Tanker trucks containing de-chlorinated water can also be used as a water source.

### BMP MAINTENANCE

- Maintain water quality in accordance with permit requirements

**BMP REMOVAL**

- No removal needed of gravel placed

## Hand Work

### BMP

#### Hand Work

---

##### DESCRIPTION

Removal of very small volume of sediments and debris within watercourses and streams, stream crossings and bridge structures; planting of small disturbed areas with grass, shrubs, or trees; eliminating very small areas of noxious, nuisance vegetation, or reducing small areas of vegetation obstructions. Includes the removal of trash and debris at small localized areas by hand and/or with hand tools.

##### PURPOSE

The purpose of this BMP includes, but is not limited to:

- Minimizing the impact to soils and surrounding vegetation in small, localized areas
- Decreasing soil erosion and minimizing siltation
- Providing bio-filtration
- Minimizing soil particles, sand, and debris from discharging to surface waters of the state
- Reducing turbidity
- Maintaining and/or providing habitat and shade when work is performed adjacent to waters of the state
- Maintaining and/or providing habitat for prey base organisms such as macro-invertebrates

##### APPLICATIONS

This BMP may be used in any road structure including but not limited to: ditches, watercourses and streams, and/or sensitive areas, bridges, parking lots or at road crossings. It will generally be used for small volumes, or very limited areas, in localized sites and/or in combination with other BMPs.

##### LIMITATIONS

This BMP should not be used:

- If required, this BMP must be used in accordance with permit requirements in watercourses or streams
- If it creates a potential worker and/or public safety hazard
- For use in small volume sediment or debris removal where other BMPs may be more appropriate



## **CONSTRUCTION GUIDELINES**

- Site specific uses in small areas
- If entering a confined space use appropriate confined space entry regulations procedures
- Remove material and reuse or dispose of off site
- Reseed disturbed soils if appropriate

## **BMP MAINTENANCE**

- After planting is completed, inspect periodically and make any required replants

## **BMP REMOVAL**

- BMP removal is not applicable

## HEPA Filter Vacuum

### BMP

## **Hepa Filter and Vacuum Equipped Power Tools**

---

### DESCRIPTION

Some types of power tools, such as industrial vacuums, rotopeens, grinders, sanders, and needle scalers, may be fitted with a backpack or remote High Efficiency Particle Arresting (HEPA) filtration system and vacuum systems capable of capturing over 99% of certain site dust and most allergens in best case conditions.

### PURPOSE

The purpose of this BMP is to filter out dust and allergens when using hand tools and small power tools equipped with a vacuum system with a HEPA filtration system.

### APPLICATIONS

This BMP may be used, but is not limited to:

- In combination with other BMPs
- During bridge maintenance
- During removal of debris in heavily scaled areas
- During the removal of paint
- During the removal of surface contaminants from bridge surfaces left after other BMP cleaning methods
- During the removal of deteriorated paint debris
- During cleanup of bridge trusses where vactors, sweepers, and other equipment can not reach
- In or on other structures when other equipment can not be used

### LIMITATIONS

This BMP should not be used:

- To remove large chunks of debris
- Underwater
- In areas that may place employees at risk

## CONSTRUCTION GUIDELINES

Operations such as abrasive blasting, sanding, burning, cutting, or welding on steel structures coated with paint may produce concentrations of lead dust and fumes.

Containment systems designed to reduce environmental contamination by capturing particles of paint and used blasting material may result in airborne concentrations of lead.

- Use a fine particle filter BMP when vacuuming fine sandblasted material dust or other fine debris.
- A power tool with HEPA type BMP vacuum for paint preparation methodology.
- Employees are to use personal protective gear along with this BMP.
- Review operation of the filter regularly.
- Review volume collected to control weight when working in lifts or above ground.
- Weight restrictions of lifting devices may limit use. Weight restrictions include the weight of everything (add to the platform or the lift, employee and tools plus material collected).

## BMP MAINTENANCE

- The filter should be replaced when it has small holes or tears.
- The filter should be cleaned when a noticeable degradation in the performance occurs. See manufacturer's instructions.
- Dispose of collected material appropriately.
- Follow manufacturer's instructions for operation and safety requirements of the BMP used.

## BMP REMOVAL

- Review site to determine if the BMP is no longer needed to control dust or allergens

## Material and Equipment Use Over Water

### BMP

#### **Material and Equipment Use Over Water**

---

##### **DESCRIPTION**

This BMP consists of the use, storage, and disposal of materials and equipment on barges, boats, temporary work pads such as hydrolifts, Under Bridge Inspection Truck (UBIT), traveler, spyder, ecology tanks, and backhoes or similar equipment that minimizes or eliminates the discharge of potential pollutants to a watercourse.

##### **PURPOSE**

The purpose of this BMP includes, but is not limited to:

- Providing a dry work platform above or on a stream or waterway
- Managing falling debris (such as: cement chips; bird nests and fecal material; dirt, moss, sediments, rust; paint chips; and petroleum products)

##### **APPLICATIONS**

This BMP is used but is not limited to: bridge scour repair, pipeline and pier inspections, maintenance repairs, and debris or sediment removal. Also maybe used in maintenance activities such as scour repair. It may be used in combination with other BMPs.

##### **LIMITATIONS**

This BMP should not be used:

- In shallow waters where there is the potential to bottom out unless allowed within permits
- During periods of high winds or strong currents that reduce the effectiveness of the BMP

##### **CONSTRUCTION GUIDELINES**

- When used in watercourses or streams, use in accordance with permit requirements
- Follow Coast Guard boater safety recommendation and guidelines
- Launch from an appropriate facility
- Containment or absorbents should be placed under equipment placed on boats, barges, or other structures over water bodies
- Provide watertight curbs or toe boards to contain spills, reduce materials, tools and debris from leaving the barge, boat, platform, etc.
- Secure equipment and materials to reduce discharges to receiving water via wind or current

### **BMP MAINTENANCE**

- During construction, operation, and/or maintenance, inspects BMPs daily during the workweek. Schedule additional inspections during storm events. Make repairs as needed to BMPs.
- Inspect and maintain associated BMPs and perimeter controls to provide protection of the watercourse.
- Crew provides progressive clean up of debris during the course of work.
- Crews implement measures for storage and use of materials and equipment.

### **BMP REMOVAL**

- Review site to determine if BMPs are no longer needed

## Pocket Pond

### BMP

#### **Pocket Pond**

---

#### **DESCRIPTION**

Pocket pond is a below-grade depression within a ditch constructed immediately upstream of a culvert out fall or vegetative strip that collects and reduces sediments from moving down grade. A pocket pond reduces smothering of vegetation, retains settled material between cleanings, and reduces the frequency and scope of general maintenance demands on the drainage system. Pocket ponds also enhance the filtering capability of the healthy vegetation down grade by removing sediment.

#### **PURPOSE**

The purpose of this BMP includes, but is not limited to:

- Containing sediment at locations where it could be removed easily
- Protection of vegetation down stream, which could provide improved bio-filtration
- Could reduce sedimentation down stream
- Allow sediment removed to be in locations that reduce damage to the drainage system or watercourses from construction equipment

#### **APPLICATIONS**

This BMP may be used in ditches (including ditches which are watercourses or streams) or at road crossings. It can be used in combination with other BMPs. The pocket pond provides a retention basin to settle out suspended material and provide a centered excavation site.

#### **LIMITATIONS**

This BMP should not be used:

- In drainage systems with high slopes
- At sites generating greater than 0.5cubic feet per second (cfs) for the 10-year storm
- At sites with limited or no access

#### **CONSTRUCTION GUIDELINES**

- When used in watercourses or streams, pocket pond must be used in accordance with permit requirements
- The pocket pond must be the same width or less than that of the drainage channel
- Pocket depth should be from 1 foot to maximum of 3 feet
- The length should be at least 2 times the width of the channel

## BMP: Pocket Pond (continued)

- Pocket can be stabilized with a rock lining if needed.

### BMP MAINTENANCE

- Remove sediments, as necessary
- Reshape pocket after cleaning pocket
- Removed sediment will be transferred to a maintenance yard for reuse or disposed

### BMP REMOVAL

- BMP removal is not necessary.

Figure 3: Plan view of in-line "Pocket Pond" (elevations in inches).

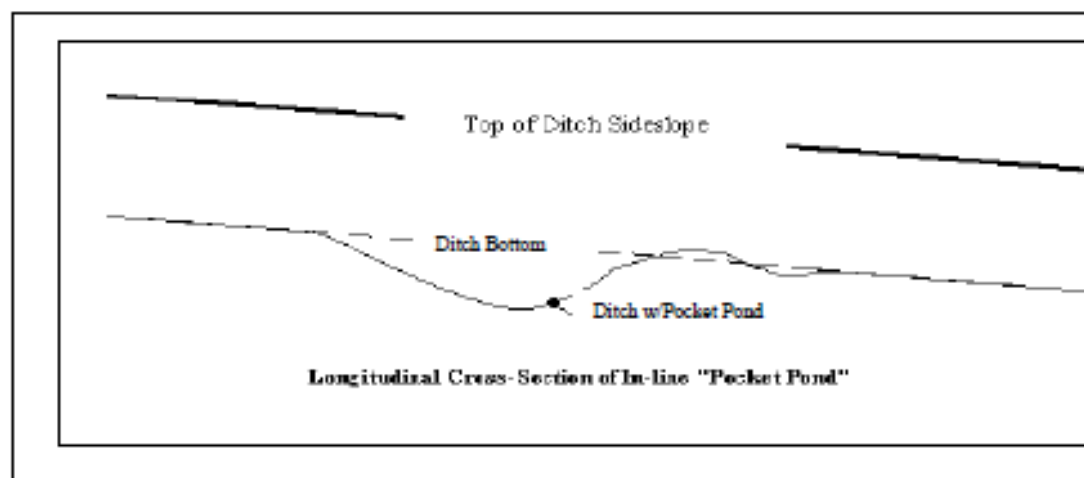
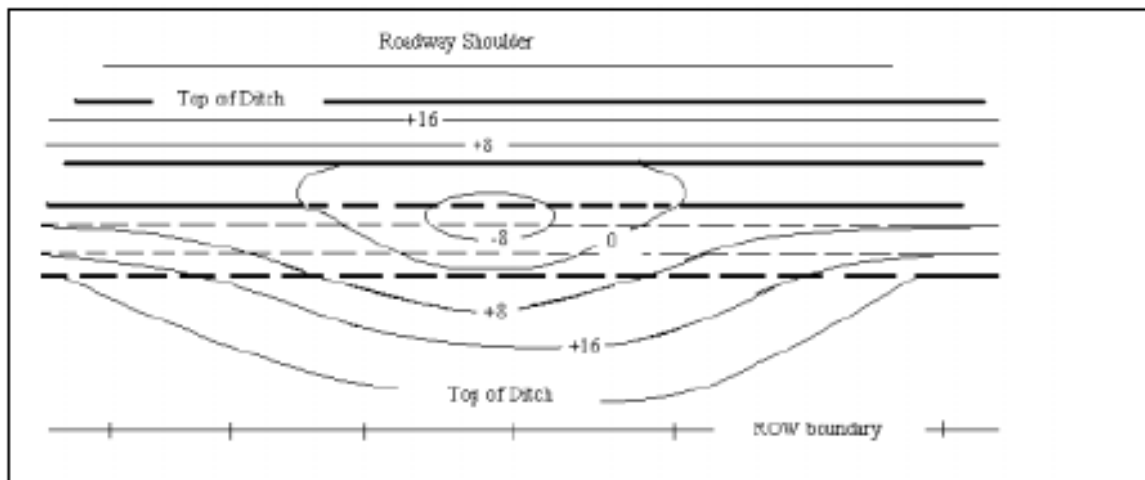

Figure 4: Longitudinal view of in-line "Pocket Pond".



## Pull Dozer

### BMP

#### **Pull Dozer**

---

#### **DESCRIPTION**

The pull dozer is a tool used to safely clear oversized debris and accumulated sediments that are too large or compacted for a jet rod/vactor truck to efficiently remove from concrete culverts. Pull dozers can be fabricated in various sizes for different sized culverts. The prototype is composed of a five foot long, one foot wide frame built from welded four inch steel tube with a road grader blade welded to the bottom of the rear end. The frame has attachment points at both ends for the steel cables used to pull the dozer back and forth through the culvert from end to end.

#### **PURPOSE**

The purpose of this BMP includes, but is not limited to:

- Removal of accumulated sediment or debris in culverts and other situations where the jet rod/vactor combination is not effective
- Use in situations where it is desirable to minimize the use of water in clearing the obstructed drainage system
- Use in situations where it is not safe or practical to have personnel in the culvert.
- Grading or installing fish gravel in enclosed concrete culverts where other mechanical options are not practical

#### **APPLICATIONS**

This BMP may be used in enclosed drainage systems to remove accumulated gravels, cobbles and debris that resist removal by jet rod/vactor. It also permits the removal of heavy debris in areas that can not be safely accessed by utility workers. This BMP can also be used to grade out existing gravels within culverts that may diminish the carrying capacity of the drainage system while leaving gravels in the culvert for fish passage.

This technique can also be used to install gravels in new culverts without the need to carry the material into the pipe by hand or using small motorized equipment in the enclosed space. This technique allows the work to be undertaken without the hazard of having people and heavy equipment operating together in the confined space. There may be some opportunities to install gravel in smaller existing culverts without replacement.

Since the pull dozer is not motorized and the equipment used to pull it through the culvert remains on the roadway, drainage system, or on the shoreline, this BMP has the benefit of keeping motorized equipment and their fuels outside of the stream channel.



## LIMITATIONS

This BMP should not be used:

- In flowing water unless permitted
- In situations that can pierce or be otherwise damaged by the grader blade
- For streambed gravel placement when cobbles must be individually placed to achieve critical grade controls

## CONSTRUCTION GUIDELINES

- When used in water courses or streams, this BMP must be used in accordance with permit requirements
- Use of the pull dozer requires an excavator, a dump truck, two snatch blocks, choker chains, three D rings, one steel cable approximately twice the length of the culvert, one pickup truck mounted winch with steel cable, short-term use of a tractor truck and a length of high strength nylon rope
- If there is flow within the subject drainage system it may need to be bypassed around the work area prior to deploying the pull dozer in permit required areas

## CONSTRUCTION SEQUENCE

- Construct turbid water settling basin or equivalent facility as needed.
- Bypass flows if required by permit.
- Run a length of nylon rope through the culvert. A jet rod may be used to run rope through culvert and may also be used to loosen and flush out fine sediments that tend to lock in the larger debris.
- Mount the snatch blocks upstream of the inlet and downstream of the outlet. The snatch block must be in line with the center of the culvert. They must be mounted firmly on an immobile anchor such as a large tree or stump. The excavator, if sufficiently large, can also be used as an anchor point.
- Use the rope to pull the steel cable through the length of the culvert. Loop the cable through the downstream snatch block.
- Attach the steel cable to the front of the pull dozer at the culvert inlet. The other end of the cable runs through the snatch block downstream of the culvert.
- Mount the winch cable to the rear of the pull dozer. This cable is run through a snatch block mounted in line with the culvert bore at the inlet.
- When ready to draw the pull dozer through the culvert, attach the steel cable to the trailer hitch of the dump truck.
- The dump truck then travels away from the culvert pulling the pull dozer through the culvert to the outlet. Sediments and debris collected on the blade is pulled out of the culvert where it can be removed by the excavator if necessary and loaded into the truck.

## BMP: Pull Dozer (continued)

- Following each pull through the culvert the pull dozer is drawn back upstream through the culvert by the pick up truck mounted winch.
- Repeat as needed to clear the culvert.
- To place material in the culvert, reverse the orientation of the pull dozer so that material placed outside the culvert outlet can be pulled into the culvert toward the inlet.

### BMP MAINTENANCE

- None required

### REMOVAL OF BMP

- Following completion remove any perimeter protection measures, remove cables, snatch blocks and any other equipment from the drainage system.
- Remove bypass BMPs if installed.



Figure 5: Pull Dozer deployed at culvert outlet. Note snatch block mounted to excavator bucket used to mount cable pulling the dozer through the culvert and the smaller cable mounted at the rear used to pull it back into the culvert.





**Figure 6: Pull Dozer in the culvert seen from the culvert outlet.**



**Figure 7: Pull Dozer with large cobbles removed from the culvert.**

## Pump Intake Screen

### BMP

#### **Pump Intake Screen**

---

##### **DESCRIPTION**

A pump intake screen may be created by using a bucket and a fine mesh net. The pump intake is inserted into the bucket. The mesh net is then attached to the pump intake hose and the mouth of the bucket, forming a barrier that will prevent material larger than the mesh from being drawn into the pump intake.

##### **PURPOSE**

A pump intake screen is a secondary measure used to reduce aquatic life form entering the pump hose. This BMP is used in conjunction with other BMPs as described in the [Fish Exclusion Protocol \(Appendix E\), most recent version of NOAA Fisheries Fish Exclusion Protocols and Standards.](#)

##### **APPLICATIONS**

This BMP may be used while dewatering a worksite. It is installed, as a precautionary measure, to reduce any aquatic vertebrates that may have been missed in the exclusion process. The screen and bucket will also reduce fish and other wildlife from entering the pump if a BMP should fail.

##### **LIMITATIONS**

- Screen mesh size shall follow WDFW standards to ensure aquatic vertebrates are adequately protected.

##### **CONSTRUCTION GUIDELINES**

- Place and operate pump in a manner such that water enters the bucket and reduces impingement of fish on the hose intake.
- A "well point" can be used in place of an intake screen if permit allows.

##### **BMP MAINTENANCE**

- Maintain screen to reduce injury or entrapment of aquatic vertebrates.
- Inspect periodically to assess if BMP is functional and debris is not blocking intake.
- Ensure the mesh screen is attached securely, intact and is in good repair.

##### **BMP REMOVAL**

- The pump intake screen may be removed when dewatering of the worksite is no longer needed.

## Pump Intake Screen and Pump Outlet Energy Dissipater

### BMP

### **Pump Intake Screen and Pump Outlet Energy Dissipater**

---

#### DESCRIPTION

A device that is attached to a pump intake hose to screen the intake flow, or is attached to the pump outlet to dissipate energy at the outlet end of the hose. The device may consist of a corrugated metal culvert section 3 feet long, 18 inches in diameter, with plates attached on each end. The device has 3/16" holes drilled all over the surface. A hole is cut in the culvert section and a flange that is compatible with the pump hose fittings is attached over the hole. Adaptors can be added to allow the unit to be coupled to 6", 4" and 3" pump fittings. Smaller devices can be constructed for 2" and 1" pumps. Collars can be added to provide lifting points.

This BMP may be a secondary screen that is used in conjunction with block nets to exclude aquatic animals from a work site.

#### PURPOSE

The purpose of this BMP includes but is not limited to:

- Minimizing fine sediment activation or discharge caused by the suction of the pump head when pumping in soft or easily mobilized substrates
- Reducing the chance of fish and aquatic animals from being sucked into the pump
- Reducing the chance of erosion and sedimentation at the pump outlet by dissipating the kinetic energy of the outflow

#### APPLICATIONS

This BMP may be used any time pumping is needed or where fine sediments are present at the pump intake; or when aquatic animals and fish may be present at the intake; or when erosion control is needed at the pump outfall. This BMP may be used in conjunction with other BMPs such as cofferdams and stream bypass BMPs. The BMP may be used with any size pump, but BMP should match the capacity of the pumps.

#### LIMITATIONS

The BMP requires that water be deep enough to submerge the intake. This may be accomplished by building a cofferdam or digging a sump where necessary depending on use.

## CONSTRUCTION GUIDELINES

- When used in watercourses or streams, construction must be in accordance with permit conditions
- In dewatering of a site install block nets and remove aquatic vertebrates from the work area
- Attach the intake screen to the pump intake and/or outlet as needed
- If used as an energy dissipater, determine if BMP should be placed on top of plastic sheeting or similar BMP to minimize scour
- Commence pumping

## BMP MAINTENANCE

- Inspect screen for debris accumulation. Clean as necessary.
- Review out flow and adjust as needed.

## BMP REMOVAL

- Remove BMP when no longer needed and recycle and/or reuse if applicable.

Figure 8. Example of a pump intake screen and pump outlet energy dissipater.





**Figure 9: Pump Intake Screen.**



**Figure 10: Outlet Energy Dissipater.**



## Secondary Containment Pumps

### BMP

#### Secondary Containment of Pumps

---

##### DESCRIPTION

Secondary containment may be used with pumps or other small equipment that contains fuel and/or oil. Pumps will be placed in a container capable of retaining fuel and/or oil in the event of leaks and/or spills. Secondary containment may be used when the equipment is operating in or near a stream or wetland.

##### PURPOSE

Secondary containment is used to reduce or avoid accidental spills of liquid like fuel and/or oil into aquatic areas.

##### APPLICATIONS

Secondary containment of pumps may be used when pumps are necessary to dewater a location where site geometry requires placing the pump in or near a stream or wetland. This BMP is commonly used in conjunction with pumps or small equipment usage and with other BMPs like the stream bypass BMP using pumps.

##### LIMITATIONS

- Use other types of containment if fuel liquid may be spilled from the containment due to wave action, movement at the BMP, or other actions

##### CONSTRUCTION GUIDELINES

- Place and operate pump in a manner that collects spills or leaks within the container

##### BMP MAINTENANCE

- Review the BMP daily and during fueling for functional control and container integrity

##### BMP REMOVAL

- Remove any collected liquids, being sure to use proper disposal methods
- Remove containment system



## Silt Fence Sediment Basin

### BMP

### Silt Fence Sediment Basin

---

#### DESCRIPTION

A silt fence sediment basin is a temporary containment area through which sediment-laden water is pumped so sediment is temporarily detained under quiescent conditions, allowing sediment to settle out during infiltration.

#### PURPOSE

The purpose of this BMP includes, but is not limited to:

- Trap and retain sediment-laden water from a work site

#### APPLICATIONS

This BMP may be used:

- Where sediment-laden water may enter the drainage system or watercourses and streams
- In combination with other BMPs

#### LIMITATIONS

This BMP should not be used:

- Where rock or hard surfaces prevent the full and uniform anchoring of the foot of the barrier
- Size may be limited by availability of right-of-way
- Less effective unless trenched and keyed in
- Where volume of water exceeds infiltration rate or 3/4 of the storage volume of the BMP
- Not to be located in watercourses and streams

#### CONSTRUCTION GUIDELINES

- Locate silt fence sediment basin in a location that provides access for maintenance, including sediment removal.
- The BMP may be placed on a relatively flat grade.
- Must be installed in a circular configuration.
- Wire mesh backing silt fence is required. Wire backing shall be positioned on the outside of the circle with the fabric side facing in.

## BMP: Silt Fence Sediment Basin (continued)

---

- Standard metal T posts with a welded plate should be used. T posts should be spaced 2 to 3 feet apart, depending on size of the circle. T posts are positioned on the outside of the circle against the wire back.
- There must be at least a 3-foot overlap at vertical seams to reduce leakage. Both ends of the overlap must be securely attached to the posts.
- The bottom of the fabric must be continuously and securely anchored for its entire length to reduce undermining.
- Both inside and outside the circle must be backfilled with tamped soil.
- Secure wire backing to T posts with wire ties. For added strength the tops of the T-posts can be secured with wire to the opposite post within the circle.

### BMP MAINTENANCE

- During use, inspect BMPs daily. Make any required repairs.
- Repair undercutting/seepage by placing addition soil on the inside of basin against fabric.
- Monitor pumping to prevent basin from being overtopped.

### BMP REMOVAL

- Evaluate site to determine when basin is no longer needed (the area has stabilized – potential of sediment laden water exiting the area has passed)
- When wire back silt fence is removed it shall be in such a manner as to minimize disturbance
- Remaining sediment may be removed, re-used, and/or disposed of according to permit conditions (if applicable)
- Re-vegetate area disturbed by BMP removal

# Skip Ditching

## BMP

### Skip Ditching

---

#### DESCRIPTION

Skip ditching is a type of ditch maintenance where a vegetated filter strip downstream of the sediment removal areas within a ditch segment is left in place to be cleaned in the future, as needed.

#### PURPOSE

The purpose of this BMP includes, but is not limited to:

- Cleaning part of a drainage system
- Providing bio-filtration
- Reducing sediment transport
- Reducing turbidity

#### APPLICATIONS

This BMP may be used in ditches (including ditches which are watercourses or streams). Normal revegetation will be grasses and small forbs. Revegetation in watercourses will be completed in accordance with permit requirements and federal highway safety design standards. This BMP will generally be used in combination with other BMPs.

This BMP provides long-term soil stabilization by not removing all the vegetation and by re-vegetation of disturbed areas with grass. Soil stabilization may be achieved in combination with other BMPs. For example, temporary BMPs such as rock check dams, straw bales, triangular silt dike, or silt fencing will help contain soils until vegetation is established.

#### LIMITATIONS

This BMP should not be used:

- Sodding instead of grass seed is not recommended over straw mulching to cover an exposed ditch perimeter following wet weather ditch excavation
- Do not fertilize grass seeded area when surface water is present

#### CONSTRUCTION GUIDELINES

- When used in watercourses or streams, skip ditching will be used in accordance with appropriate permit requirements
- Select a vegetation strip with a healthy stand of dense, tall grasses in a relatively low gradient segment

## BMP: Skip Ditching (continued)

---

- Site vegetation strip downstream of point inflows to provide maximum treatment potential
- Consider an upstream strip just below high-energy discharges to trap coarse particles and reduce sedimentation within ditch length
- Consider placing energy dissipaters, stilling basins, or flow spreaders where high discharge inflows are present
- Consider using temporary check dams (rock, straw bales, triangular silt dike, or silt fencing) to capture exposed soils loadings
- Select appropriate low grow grass seed for the location
- Plant at the appropriate time of year (April through June and October are best)
- After the cleaned section grasses revegetates, the last section of the ditch system that was left can then be maintained by cleaning and reseeding

### BMP MAINTENANCE

- Vegetated filter strips can be mowed during the summer to promote growth
- Remove woody species as necessary to prevent crowding and shading of finer plant material, which provides better filtering
- Normally sediments should be removed during summer months when there is sediment build up, cover vegetation dams, or other obstructions of optimal ditch operation
- Clean curb cuts when soil and vegetation buildup interferes with drainage system operations
- After work is completed, check vegetation until it is re-established
- Remove sediments/fertilize, and reseed as necessary

### BMP REMOVAL

- BMP removal is not applicable

## Soil Compaction

### BMP

### Soil Compaction

---

#### DESCRIPTION

Soil compaction is a procedure used to compact exposed soils so as to prevent soil erosion. Soil compaction is primarily completed on road surfaces, or road shoulder work in the vegetation free zone. Soil compaction is completed with either a rolling machine or with a rubber tired vehicle.

#### PURPOSE

The purpose of this BMP includes, but is not limited to:

- Reduce the amount of water infiltrating and eroding shoulder material
- Maintaining the shape and functionality of the road surface or shoulder
- Reduce vegetation growth on the shoulder where vegetation could present problems

#### APPLICATIONS

This BMP may be used on any road surface or on shoulder work but may be used in other areas where soil compaction would be preferred over other coverage BMP(s) such as straw or mulch.

#### LIMITATIONS

This BMP should not be used:

- In areas where vegetation growth is encouraged
- In areas where straw, mulch, or hydro seeding will be more effective in stabilizing soils

#### CONSTRUCTION GUIDELINES

- Do not attempt to compact soils on steep slopes
- Install a site specific barrier in areas where the possibility exists that work related materials could enter a watercourse
- Shoulder material should be able to handle the target weight of the equipment that may use the shoulder area without collapsing the shoulder

## BMP: Soil Compaction (continued)

---

### **BMP MAINTENANCE**

- Soils should be compacted enough so that no apparent loose materials exist where soil erosion could occur

### **BMP REMOVAL**

- No removal is necessary for this BMP

## Sump

### BMP

### Sump

---

#### DESCRIPTION

A sump is a permanent or temporary dewatering structure constructed to enclose a pump head when pumping water in wetlands or streams when large quantities of fine sediments are present. Sumps are often used when water is pumped around a work site. Sumps are constructed of porous pipe segments placed vertically into a small hole and partially filled with pea gravel. The pump head is placed in the pea gravel.

#### PURPOSE

Sumps are used to minimize fine sediment activation and discharge caused by the suction of the pump head when pumping in soft or easily mobilized substrates.

#### APPLICATIONS

This BMP may be used when pumping is required where fine sediments are present at the pump intake. This may include installation of a pump bypass when working in streams or wetlands or ditches with fine sediments. This BMP may also be used as a pump intake screen to avoid injury to aquatic animals.

#### LIMITATIONS

- A sump is usually not necessary in streams with gravel beds when the pump head is screened using alternative BMPs such as block nets and pump intake screens.

#### CONSTRUCTION GUIDELINES

- When used in watercourses or streams, the BMP will be in accordance with permit conditions
- Cofferdams may be used to initiate site bypass
- Excavate a small depression upstream of the coffer dam about 12" deep by hand or equipment
- Drive a short segment (about 3 feet) of porous 18-24" diameter pipe vertically into depression
- Fill with pea gravel to approximately the elevation of the streambed
- Insert pump intake and commence pumping

#### BMP MAINTENANCE

- Inspect pipe for debris accumulation and clean as necessary



## Supersacks

### BMP

#### Supersacks®: A Versatile In-Stream Construction Aid

---

##### DESCRIPTION

A \*Supersack® is a large reinforced plastic bag that can be filled with gravel or other material. The bag has loop handles that allow it to be lifted by an excavator, and a controllable opening in the bottom that is used to drain the bag contents when necessary. The bags shown below have the Standard Discharge Spout with a reinforced protective square bottom and cover (not visible in photos). Many different sizes are available. The bags shown in the photographs contain approximately one cubic yard of gravel. The bags have self-supporting Spread Straps™ with lift loops for ease of handling. The side seam construction allows the container to maintain a relatively square shape, increasing stability. The bags are stackable. The bag volume ranges from 10 to 85 cubic feet and can hold up to 3,000 lbs of gravel or other material.



Figure 11 Building a coffer dam with Supersacks®.





Figure 12 *Temporary stream bank protection with Supersacks®.*

## PURPOSE

The purpose of this BMP includes but is not limited to:

- deliver gravel to a stream in a controlled manner
- construct a coffer dam in larger streams
- provide temporary stabilization of eroding stream banks or road shoulders
- can be filled with trash or debris for removal from sites

## APPLICATIONS

Supersacks® filled with clean gravel can be used to construct coffer dams in larger streams, temporarily reinforce an eroding stream bank, or deliver gravel or sand to a stream channel in a more controlled manner than can be achieved using an excavator bucket. The standard discharge spout is about 1 foot in diameter and can be used to control the placement of gravel in stream channels. The bags are somewhat deformable and can form relatively tight junctions when packed together. No excavation is necessary for bag installation. The bags are light and highly portable when empty, but still strong, durable, inexpensive and re-usable.

## LIMITATIONS

When full of gravel, an excavator is needed to lift and move them. When placed in streams, they should be filled with clean gravel to limit potential impacts in case of damage to the bags. Except in an emergency, an Army Corps of Engineers permit (e.g. nationwide permit #33) may be required for the temporary placement of fill in waters of the United States even though the fill is contained in bags.

## CONSTRUCTION GUIDELINES

- When used in watercourses or streams, BMP must be used in accordance with permit conditions.
- Bags may be filled with clean gravel either on site or at gravel pits and transported to the site.
- Check that the bottom opening is secured before filling with gravel.
- When used as a coffer dam, or to protect an eroding stream bank, the bags should be packed tightly together to reduce flow between the bags. The bags can be stacked on top of each other at a 6:1 or shallower slope. The bags can also be placed on top of plastic sheeting which is then folded over the top of the bags to provide a more water tight barrier.

## BMP MAINTENANCE

- Check the BMP after each major storm
- Repair the bags when necessary

## BMP REMOVAL

- Supersacks® should be removed from the stream channel when BMP is no longer needed
- Where permit conditions allow, the gravel may be emptied into the stream channel to supplement spawning habitat
- Transport the full bags to a legal disposal site
- The bags and gravel may be re-usable

## PRODUCT INFORMATION

\*Supersacks® are manufactured by \*Bagcorp, 11510 Data Drive, Dallas, Texas 75218; telephone (800) 331-9200, email: [bagcorp@bagcorp.com](mailto:bagcorp@bagcorp.com); <http://www.bagcorp.com>. The catalog is available at <http://www.bagcorp.com/documents/catalog.pdf>. A local vendor in the Puget Sound area is \*Salmon Bay Sand & Gravel Co., 5228 Shilshole Ave NW, Seattle, WA 98107, telephone (206) 784-1234; web address <http://www.sbsg.com/index.html>.

\*Similar products may be available from other manufacturers. The use of a trade name or reference to a specific company or product does not represent an exclusive endorsement or recommendation of that product or company.

## Suspender Cable Cleaning and Painting

### BMP

#### Suspender Cable Cleaning and Painting

---

##### DESCRIPTION

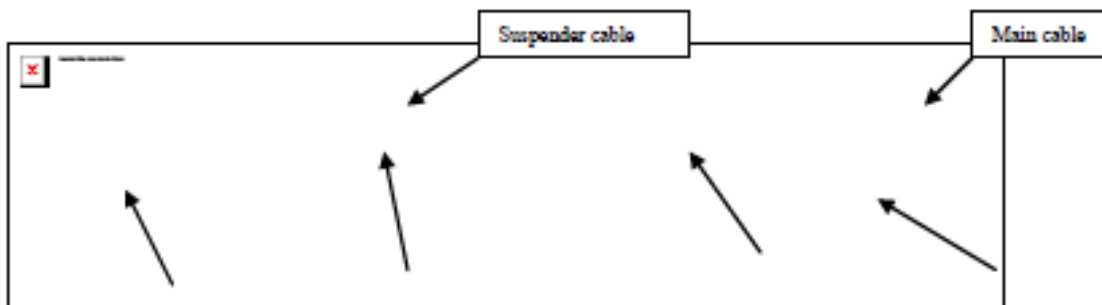

**Figure 13:** Illustration of a suspension bridge.

Suspender cables are the vertical cables hung at regular intervals that connect the traffic deck to the main cable. The suspenders, together with the main cable support the weight of the deck and the traffic crossing the bridge.

Federal regulations require steel bridge paint systems to be inspected and maintained as mitigation for the life of the bridge. Maintaining paint coatings mitigates and preserves the service life of the bridge by reducing damage due to corrosion. Bridge painting occurs on a schedule dictated by the rate at which paint systems deteriorate. In the case of suspender cables when paint is peeling or deteriorating the cables may be either replaced or repainted. The state considers both these alternatives and determines which of these are the most cost effective and least environmental impacting.

Through adaptive management, the Washington State Department of Transportation (WSDOT) Tacoma Narrows Bridge (TNB) crew with the assistance of H & H Engineering developed the following cleaning and painting BMP process for suspender cables that has been approved by the Washington State Department of Ecology.

##### PURPOSE

The purpose of this BMP includes, but is not limited to:

- Catching, containing, and reducing falling debris (paint chips and rust) from entering surface water during maintenance and repair activities

##### APPLICATIONS

This BMP may be used in, but not limited to, maintenance of suspension bridges. It will generally be used in combination with other BMPs such as: diaper netting (drop cloths), HEPA filter and/or vacuum systems.

## LIMITATIONS

This BMP should not be used:

- During periods of high winds that reduce the effectiveness of the combined BMPs used to clean cables

## CONSTRUCTION GUIDELINES

- When above watercourses or streams, use in accordance with permit requirements
- The suspender cable cleaning process may consist of two containment systems. The primary containment system consists of the following three-part removal process:
  1. Suspension Line Tool (SLT-1): This tool is used to loosen and fracture heavy paint build-up. It includes a containment and vacuum system for contaminate and particulate control.
  2. First Mate cleaning tool: This tool is used for heavy cleaning after SLT-1 has performed its task. This tool reaches into valleys for final removal of any remaining paint or dirt. It also includes a common vacuum system with the Cable Master <sup>TM</sup> Tool.
  3. Stiff bristle brushing, which also uses the First Mate cleaning tool.

All three steps of the operation use a HEPA filter vacuum attachment that is part of the cleaning system.

The secondary containment system consists of a 4' by 6' drop cloth that is placed below the operation as a preventative measure to capture paint chips and to protect against failure of the primary system. The crew vacuums all escaped paint chips that fall on the tarp and/or bridge surface (sidewalk).

- The suspender painting process consists of applying paint, using the "Cable Master <sup>TM</sup> Tool", which includes a vacuum system for particulate containment and control.
- BMP effectiveness evaluation: On September 22, 2005, data were collected to determine the loss/recovery rates of the primary BMP containment system (see Table 1). The primary BMP containment system captured 97.2% of the material. The remaining 2.8% was captured in the secondary containment system. A total of 2,117.8 grams of material was captured.



## BMP: Suspender Cable Cleaning and Painting (continued)

---

**Table 1: Suspender Cable 9/22/05 Data Collection.**

Suspender cable length	30 feet
Primary Containment - Total recovered	2,056.5 grams
Secondary Containment - Total recovered	61.3 grams
Total material recovered	2,117.8 grams
Percent lost & recovered in secondary containment (tarps)	2.8%

The method for gathering this information was to remove all the paint chips from the two HEPA vacuums that were used for the work, and weigh the results, to arrive a total material recovery of 2,117.8 grams. The amount that was captured in the secondary containment (tarps) was weighed separately from the primary containment system to determine the BMP effectiveness.

### **BMP MAINTENANCE**

- Operator is present at all times
- Make required repairs as needed
- Crew must provide progressive clean up of debris as the work continues during the day

### **BMP REMOVAL**

- Evaluate site to determine if BMPs usage is no longer needed
- Follow manufacturer's recommendations for removal (recycle and/or reuse if applicable)
- Remove debris from site for disposal
- Inspect after each individual cable is completed to make sure equipment is in good repair for next cable

# BMP: Suspender Cable Cleaning and Painting (continued)





## Terrestrial & Non-Marine Species Guide

### Terrestrial & Non- Marine Species Guide

---

Terrestrial and non-marine species are animals and plants that live on land or in fresh water. Various federal and state laws may protect them and their habitat.

#### *Purpose*

This section of Addendum 1 is intended to assist Regional Forum maintenance personnel in maintenance BMPs that reduce impacts to protected terrestrial species that occur within a half mile of a facility structure. Maintenance personnel refer to this document when scheduling work within conditional zones to determine what, if any, limitations or BMPs may apply. This document is intended to address the majority of protected plants and animals that could be affected by road maintenance activities listed in the Regional Program.

#### *Program Element 10: Best Management Practices and Outcomes*

The Regional Program conducts maintenance activities that protect the public infrastructure and public safety, which include maintenance services necessary for the daily operations of the roadway system. Maintenance categories (MC) are broken down into 15 categories including:

- MC 1: Roadway Surface
- MC 2: Enclosed Drainage Systems
- MC 3: Cleaning Enclosed Drainage Systems
- MC 4: Open Drainage Systems
- MC 5: Watercourses and Streams
- MC 6: Stream Crossings
- MC 7: Gravel Shoulders
- MC 8: Street Surface Cleaning
- MC 9: Bridge Maintenance
- MC 10: Snow and Ice Control
- MC 11: Emergency Slide/Washout Repair
- MC 12: Concrete
- MC 13: Sewer Systems
- MC 14: Water Systems
- MC 15: Vegetation

The fifteen maintenance categories in the *Guidelines* that apply to aquatic habitat BMPs also apply to the “terrestrial” species group (amphibian, bats, bird, butterflies, fish, insects, land mammals, mollusks, reptiles and plants). A table of BMPs by species group is provided in Appendix C. Thirteen of the fifteen maintenance categories have the potential to impact protected terrestrial species. Impacts could include alteration of habitat and impacts to individuals. Impacts to individuals most commonly occur as a result of disturbance during certain time periods at critical locations, such as nest sites during the breeding season. Depending on the timing and location, disturbance may



occur when an activity increases visual or audible stimuli over the existing background levels (ambient conditions).

### *Part 1 - Best Management Practices for Terrestrial Species*

The following list of new terrestrial species BMPs was developed for the Regional Program to protect the species while allowing the protective maintenance and structural integrity of the roadway system:

**Table 2: Summary of Terrestrial Species BMPs**

<b>BMPs</b>	<b>Description</b>
Birds	Removal of nest with eggs or young will be prohibited except when appropriate permits are obtained.
Burning	Prescribed burning should not be used within the vicinity of known populations except when appropriate permits are obtained.
Carcass Removal	Remove dead animal carcasses in the vicinity of known populations to reduce collisions with automobiles.
Chemical	Herbicide use will not be allowed in the vicinity of known populations without permit.
Noise/Visual Disturbance	When possible, implement noise and visual abatement measures during maintenance activities such as timing windows, buffers, and/or restricting equipment running times. See table in Appendix E, "Wildlife Sensitive Periods Calendar".
Planting	Do not plant monocultures of exotic grasses.
Scotch Broom	Select effective vegetation management practices for scotch broom.
Surveys	Conduct surveys as appropriate, to verify the presence of species or their habitat in relation to potential maintenance activities.
Timing	When possible, conduct maintenance activities outside sensitive times for protected wildlife. See table in Appendix E, "Wildlife Sensitive Periods Calendar".
Tree Removal	Prohibit cutting down any tree in zone 3 within the road ROW structure that is 12" diameter at breast height (dbh) or greater and within a wildlife buffer zone of known populations. (See table in Appendix E, "Wildlife Sensitive Periods Calendar"). Exceptions are hazard trees or trees removed as an approved plan; these may be felled and removed or left on site as habitat.

Where applicable, terrestrial species BMPs have been identified for use in thirteen of the fifteen maintenance categories described in the *Guidelines*.

### *Terrestrial Species Guidance Implementation*

This guidance is presented in a step-by-step format to facilitate use by Regional Forum maintenance personnel. Using the tables, figures and appendices as directed below, maintenance personnel can identify the following for non-emergency maintenance activities:

- Which species could potentially be present in the county or city that the activity is proposed? See Table in Appendix F. “Federally listed, proposed, candidate, species of concern that are known or suspected to occur within Regional Forum Participants”.
- Check conditional zones for the species that coincide with the work area.
- The applicable terrestrial species BMPs for that maintenance category that could be present.

## Culvert Plug

### Culvert Plug

Description – The Culvert Plug is used to isolate a work area or culvert from water, or bypass water around a work area. The plug is inserted into a round culvert and inflated in order to block the culvert. Inflatable plugs can come in various sizes with or without a flow through option. The fill hose, gauge, and lanyard combination should be purchased with the plug; this allows you to inflate, deflate, and hoist the plug without being near the danger zone should the plug dislodge while under high head pressure. Proper blocking should be used to secure the plug. This BMP should not be used on box culverts.

Purpose –

- To isolate a work area where there is concern of turbid water leaving a worksite through a culvert.
- To eliminate flow through a culvert in order to perform repairs.
- To bypass flow from a culvert around a downstream work area.



Applications – This BMP may be used to stop water from discharging through a culvert from a worksite, dewatering a worksite, or bypassing flow around a worksite. It can be used in combination with other BMPs.

Limitations –

- Area of culvert where the plug is placed must be clean of sediment to provide adequate sealing against the culvert.
- Algae on the culvert can reduce the amount of head pressure the plug can hold back (plug slippage).
- Must ensure plug is fully inserted into culvert or the top of the plug will mushroom.
- Must be cognizant of the amount of head pressure produced; i.e. Blocking or reducing significant flow from a 30" culvert could create head pressure behind the plug that exceeds the plug's holding capacity and creates a safety hazard.
- Sharp/damaged culverts can cause damage to the plug.

Construction Guidelines – See safety instructions attached to equipment

- Be sure to have the proper plug for the job; measure the inside pipe diameter. We purchased one 8"-15" plug and one 15"-30" plug.
- Be sure to purchase the inflation hose for the plugs; it doubles as a lanyard for the plug, has an accurate gauge to monitor the plug inflation pressure, allows you to fill the plug from outside the potential danger zone of a plug that may dislodge, and allows you to deflate the plug from a distance.
- Plan first: are you blocking flow from entering an area or bypassing flow around an area? Are you discharging to upland for infiltration or returning to watercourse below the worksite? Will it be a gravity bypass or will you need a pump in conjunction with the plug?



- Calculate the amount of potential head pressure and do not exceed safety parameters.
- Extreme caution must be used to ensure plug does not dislodge under pressure; use proper blocking (we used a backhoe bucket).
- Do not over inflate.
- Monitor pressure occasionally to ensure plug is not deflating/leaking.
- A cam-lock fitting on the outlet of the plug makes it more user friendly.
- When using in a flowing culvert, we found it easier to first attach the outlet hose and then insert the plug so we weren't fighting the full head pressure from inserting an obstruction in the flowing water, then immediately start inflating the plug to seal any flow coming around the plug.
- Depending on the reduction through the plug bypass and resulting increased water velocities, you may need to add a diffuser to the outlet of the hose.

#### BMP Maintenance –

- Occasionally check plug pressure to ensure it is not deflating/leaking.
- Check outlet to ensure there is no creek bed erosion.
- Use proper containment (fuel and oil) if used in conjunction with a pump.
- Do not stand in danger zone should the plug dislodge (see attachment).
- Clean with water or mild detergent.
- Have punctures professionally repaired.

#### BMP Removal –

- Slowly deflate plug from the end of the fill hose to release the head pressure behind the plug; do not stand in front of the culvert.
- Slowly release blocking that is securing the plug.
- Hoist plug out with supplied lanyard.
- If the plug was used to retain water on site, be sure that the water does not exceed regulatory limits for turbidity, Ph, or temperature before discharging.

## Filter Sock Energy Dissipater

### Filter Sock Energy Dissipater

**Description** – The Filter Sock Energy Dissipater is used to slow down water velocity and remove sediment at the downstream outlet of stream by-pass discharges. The filter sock is attached to the downstream discharge hose.

**Purpose** –

- Slow down the velocity of water discharged downstream through the by-pass.
- Remove suspended sediment from the discharge water.

**Applications** –This BMP may be used when operating a temporary stream by-pass system. It can be used in combination with other BMPs.



**Limitations** –

- Follow fish exclusion protocol prior to setting up a stream by-pass
- Ensure proper connection between the filter sock and the discharge hose.
- Store product properly when not in use to prevent deterioration.

**Construction Guidelines** –See product safety instructions

- Be sure to size the filter sock for the appropriate discharge flow.
- Monitor BMP performance.

**BMP Maintenance** –

- Check outlet to ensure there is no creek bed erosion.
- Clean BMP prior to storage.
- Have punctures professionally repaired.

**BMP Removal** –

- Follow sequence of stream by-pass removal procedures when removing filter sock.

## Water-filled Tubular Bladder

### Water-filled Tubular Bladder

#### Description -

A water-filled tubular bladder is made from polyvinyl chloride (PVC) and is available in a variety of sizes for various applications, from 6" diameter to 36" diameter with lengths ranging from 10' to 20'. Non-standard lengths can be custom ordered from the manufacturer. Water-filled tubular bladders are typically filled on the jobsite with a simple garden hose or directly from a hydrant. They can be drained and reused as often as necessary.

#### Purpose -

Water-filled tubular bladders are used to redirect water flows and prevent the possibility of contaminants from entering drains or other areas and to anchor plastic sheeting.

#### Applications -

Water-filled tubular bladders can be used for check dams, flow control, flow diversion, and as an alternative to sandbags as referenced in BMP C-123: Plastic Covering. These products may be used for curb inlet protection, are designed to prevent erosion of hillsides and slopes, to protect soil stockpiles and/or contaminated soil stockpiles, and can be utilized for controlling and containing water flow from heavy rains. Once the bladders are secured to a tarp or plastic covering, the evenly dispersed water provides all the weight needed to hold down the covering properly. The water anchors can then be drained, rolled up, efficiently stored, and re-deployed at any time.



Flow Control



#### Limitations -

- For perimeter protection, ensure that the water-filled tubular bladder forms a seal to the ground to prevent leakage.
- For anchoring purposes, ensure that the water-filled tubular bladder is secured firmly to the plastic so that it will not move.

#### Construction Guidelines -

- Follow manufacturer's guidelines for selection and installation of product.

#### BMP Maintenance -

- Inspect the water-filled tubular bladder for leaks and to ensure that it is functioning properly.



### **BMP Removal -**

- Remove BMP when proper containment measures have been taken or when BMP is no longer needed.
- Follow local and state regulations for proper decontamination and waste handling

## Wood Strand Erosion Control Mulch

### Wood Strand Erosion Control Mulch

#### Description -

Wood strand erosion control mulch is a long lasting material manufactured from scrap plywood veneers, typically Douglas fir, and consisting of two sizes of geometrically regular wood elements that have a straw-like form and function. The components of the blend contain a proprietary mix of both short and long wood fibers, each with a high length-to-width ratio, such that the pieces form a protective matrix when distributed on the soil. The materials are inherently free of noxious weed seeds and devoid of any chemical/additives that could be detrimental to the environment. Wood-strand mulch is packaged in small bales measuring approximately 14" x 18" x 18" and have a target weight of 50 lbs. Large bales measure approximately 30" x 40" x 42" and have a target weight of 600 lbs.

#### Purpose -

Wood strand erosion control mulch provides immediate protection from erosion. Like all mulches, wood strand erosion control mulch is used to prevent raindrop impact and rill formation and to promote revegetation. It enhances plant establishment by conserving moisture, holding fertilizer, seed, and topsoil in place, and moderating soil temperature.

#### Applications -

Wood strand erosion control mulch can be used for many applications including, but not limited to, post-wildfire emergency response, stabilization of eroded slopes or disturbed soils, pipeline and power line maintenance operations, and other applications within rights-of-way. Wood strand erosion control mulch has been approved by Ecology for all applications identified in BMP C121: Mulching, found in Volume II of the Stormwater Management Manuals for Eastern and Western Washington.



Photos courtesy of Woodstraw®, a product of Forest Concepts, LLC.



### Limitations -

- Wood strand erosion control mulch should not be applied in areas subject to concentrated surface water flows.
- When used below the ordinary high water mark this mulch should be covered with a net or blanket to prevent flotation.

### Construction Guidelines -

- Wood strand erosion control mulch is easily applied by hand or can be mechanically applied with a straw blowing machine.
- Follow manufacturer's guidelines for selection and installation of product.



40% Cover  
80 Regular bales / acre  
7 Large bales / acre  
Slopes < 5%



50% Cover  
150 Regular bales / acre  
13 Large bales / acre  
Slopes < 33%



70% Cover  
276 Regular bales / acre  
24 Large bales / acre  
Slopes > 33%

Photos courtesy of Woodstraw®, a product of Forest Concepts, LLC.

### BMP Maintenance -

- Inspect wood strand erosion control mulch after severe rain events to ensure that it is functioning properly. Reapply mulch if necessary.
- Investigate the cause of any area showing evidence of erosion. If the erosion problem is drainage related, then fix the problem and reapply mulch to the eroded area.

### BMP Removal -

- Wood strand erosion control mulch is a sacrificial BMP that under normal conditions does not need to be removed. It will decay on site over a period of several years.

## Spring Berm

### Spring Berm

**Description** – The Spring Berms are used temporarily in channels and ditches to reduce the velocity of water run-off which helps to prevent erosion and retaining sediment. Spring Berms are pop-up berms that are made from tubular fabric body with skirts extending from both upstream and downstream for anchoring to the ground. A helical metal spring in the body keeps the body round and can be placed side to side to occupy a wider ditch. The permeable design allows for the dissipation of energy both through and over the structure.

#### **Purpose** –

- Slow down the velocity using dissipation and reduce erosion.
- Remove suspended sediment from the water.

**Applications** –This BMP may be used for temporary check dams in ditches of any dimension, temporary interceptor dike and swale.



#### **Limitations** –

- This BMP should not be used when maintenance activities are conducted in locations that could reduce actual or potential high flow salmonid refuge functions.
- Can be used as a standalone product, however best results are obtained in combination with an erosion control blanket.
- Store product properly when not in use to prevent deterioration.

#### **Construction Guidelines** –See product safety instructions

- Install properly to prevent water from going underneath the skirts or around the BMP.
- 8-10" metal or wood stakes can be used to hold the BMP securely down.
- Monitor BMP performance.

#### **BMP Maintenance** –

- During construction, inspect the BMP's daily during the work week.
- Schedule additional inspections during and after storm events.
- Sediment or debris should be removed (relocated to in an approved waste area) when material reaches one-half the height of the BMP
- Clean BMP prior to storage.
- Have punctures or rips professionally repaired.

#### **BMP Removal** –

- Evaluate site to determine BMPs are no longer needed (the area has stabilized)
- Remove sediment buildup in front of the BMP
- Evaluate the area beneath the BMP to determine if re-vegetation is necessary.



## Water Barrier



### **WATER BARRIER (Water-Gate™)**

#### **DESCRIPTION**

A Water-Gate™ is a manufactured water barrier that was developed for flood control, but may also be used for isolating road maintenance work areas from water. The Water-Gate™ provides a temporary/portable dam or barrier that can be positioned to divert or contain the movement of water.

#### **PURPOSE**

The purpose of this BMP included, but is not limited to:

- Providing a dry construction area in a stream or waterway.
- Providing a bypass for a stream or waterway.
- Isolating water from the work zone.

#### **APPLICATIONS**

This BMP may be used for stream bypass at road maintenance sites and for activities such as culvert installation, culvert repair, ditch/channelized stream maintenance, and bridge maintenance. It may also be used for habitat restoration, flood control and as a portable dam for other activities. This BMP is suitable in waterways composed of normal stream gravels.

#### **LIMITATIONS**

This BMP should not be used:

- In waters of the state unless permitted by the appropriate agency or agencies.
- Other than specified by the manufactures guidelines.

This BMP should be evaluated by an engineer when used:

- In areas of deep water (where overtopping may occur).
- In high velocity flows or standing water.
- In waterways with large substrate (cobbles) or extremely smooth, clay or sand bottoms.

*Note:* Ballast weights may trigger additional permit requirements depending on the type used.

#### **CONSTRUCTION GUIDELINES**

- When used in waters of the state, water barriers must be used in accordance with permit requirements.
- Refer to Appendix E for Fish Exclusion Protocols.
- Follow the manufactures recommendations and guidelines for installation.
- The water barrier can be pre-installed on dry ground or in flowing water.
- Multiple water barriers may be joined together to increase the barrier size.