

In this tutorial you will learn:

- How to define Nodes and Reaches.
- How to create layouts.
- How to use the compute command in the layout view.
- How to generate a report for all the elements in the layout view and the output.

Example

Create a storm drain network in the layout view and design the pipes using the 25-year short duration storm. Determine pipe sizes required given the following information.

- The section of roadway is in a **sag** condition, with CB3 and CB4 located at the low point.
- The curve crest is **600 feet north** of CB1/2 and South of CB5/6, see Figure 1.
- Assume **catch basins type 1** for the structure type.
- The pipes should always be designed for the worst case Schedule A pipe, that is a Manning’s value of **n=0.013**.
- For the entrance loss coefficient, assume a **square edge with Headwall**.

Figure 1 – PLAN VIEW

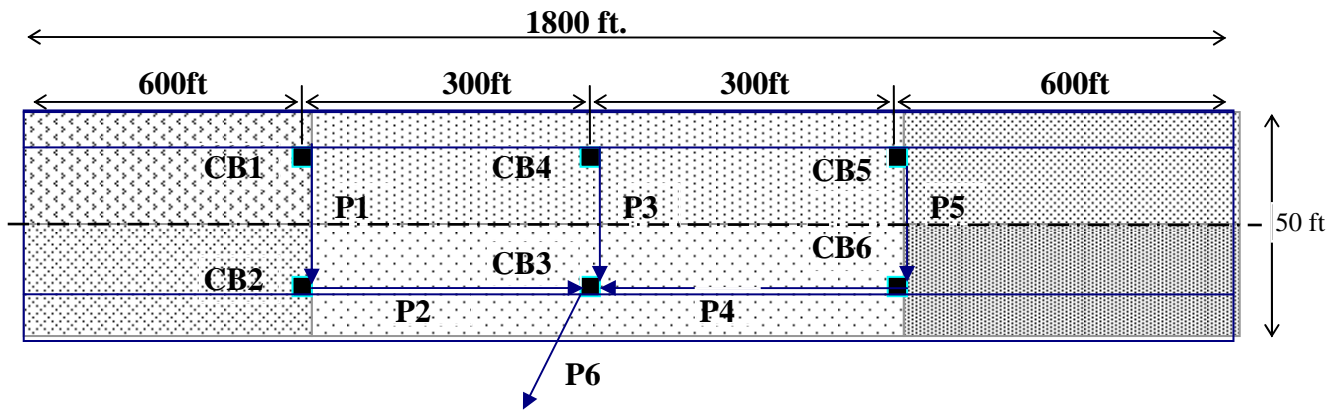

Figure 2 - CROSS SECTION

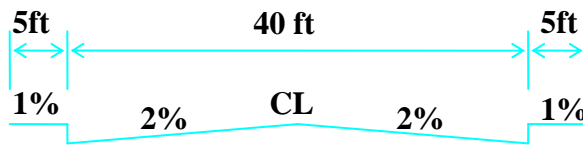
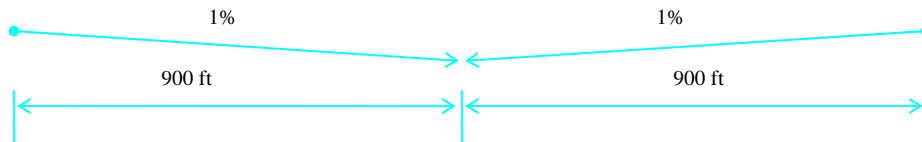

Figure 3- PROFILE



Use the following data when creating nodes and reaches:

Catch Basin	Outlet Inv El.	Rim El.
CB1	332.5	337.0
CB2	332.0	337.0
CB3	330.0	336.0
CB4	330.5	336.0
CB5	334.8	338.5
CB6	334.5	338.5
Dummy	325.0	330.0

Pipe	Length	Upstream Inv.	Slope
P-001	36	332.5	1.39%
P-002	298	332.0	0.67%
P-003	36	330.5	1.39%
P-004	298	334.5	1.51%
P-005	36	334.8	0.83%
P-006	15	330.0	33.33%

Design Criteria for Storm Drains

Chapter 6 of the Hydraulics Manual contains the design requirements for storm drain design. In summary they are:

- Velocity should be between 3 and 10 ft/sec in full condition.
- Inlet structures should be no more than 300 feet apart. (Designers should verify this with Region Maintenance).
- Align the crowns (the internal high point) of pipes that are entering and leaving a junction.
- The minimum pipe diameter is usually 12”.
- Pipe slopes should be between 0.5% and 5%.

Determine Project Configuration

Create a New Project called **network**.

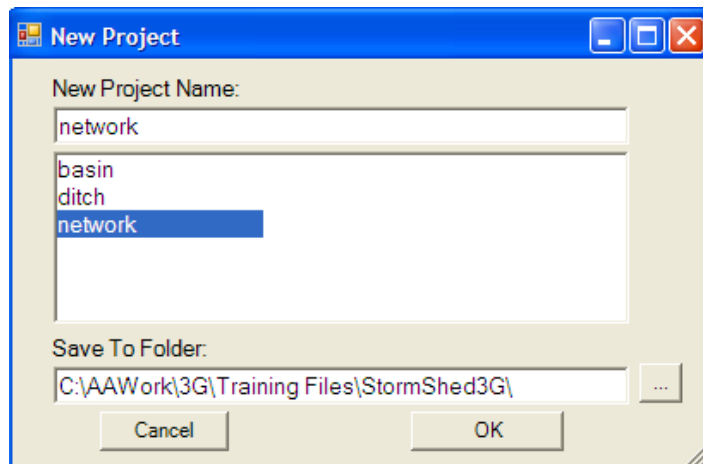

The first step in any project is to customize defaults in the *Project Configuration*. In this case we are going to modify the *Default Labels* to something that would be more meaningful for our project including:

- Change the Padding to '0' for the Reaches, Nodes, and Basins.
- Change the prefix for Nodes to **CB** and **delete the hyphen** after Basins and Reaches.
- The Default Labels tab should look as shown below:

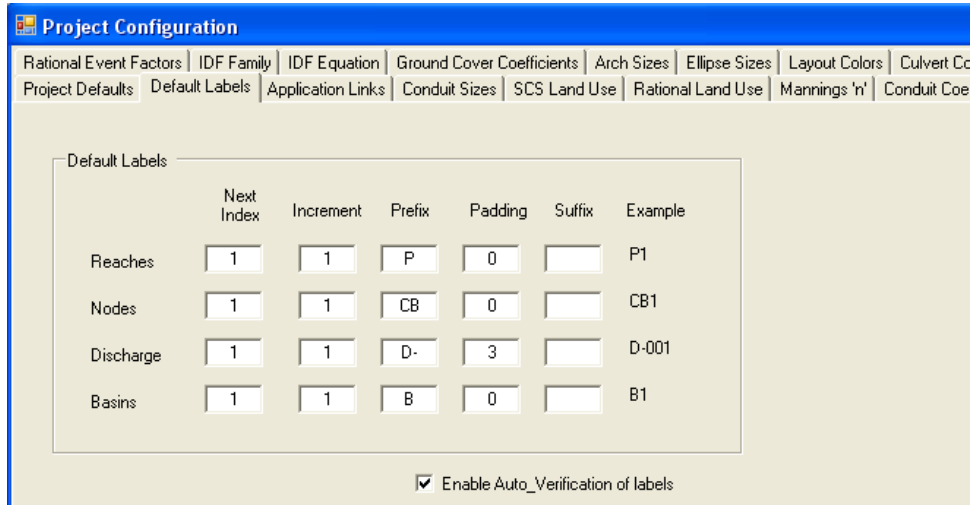

Next select the *Project Defaults* tab. For this project we will use the precipitation values calculated in 'Basin and Design Storm' Tutorial, all other default values will remain. After modifying the precipitation values, the '*Project Defaults*' tab should look as shown below.

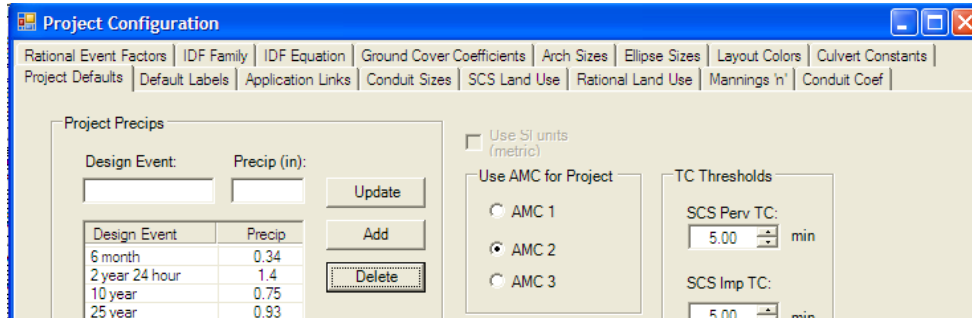

Basin Calculations

The next step is to perform the basin calculations, in other words determine how much runoff is going to each inlet. That information will be used to create our basins in 3G.

- Determine the area (in acres) that is contributing runoff to each inlet. Be sure to include the runoff from the 5' wide sidewalk.

$$B1 = 25' \times 600' / 43560 \text{sqft/acres} = 0.344 \text{ acres}$$

- All the basins are the same size; however the length of flow to inlets CB4 and CB3 is only 300', not 600'. Since this will affect the time of concentration calculation, we will need 2 basins for this project; B1 and B2.

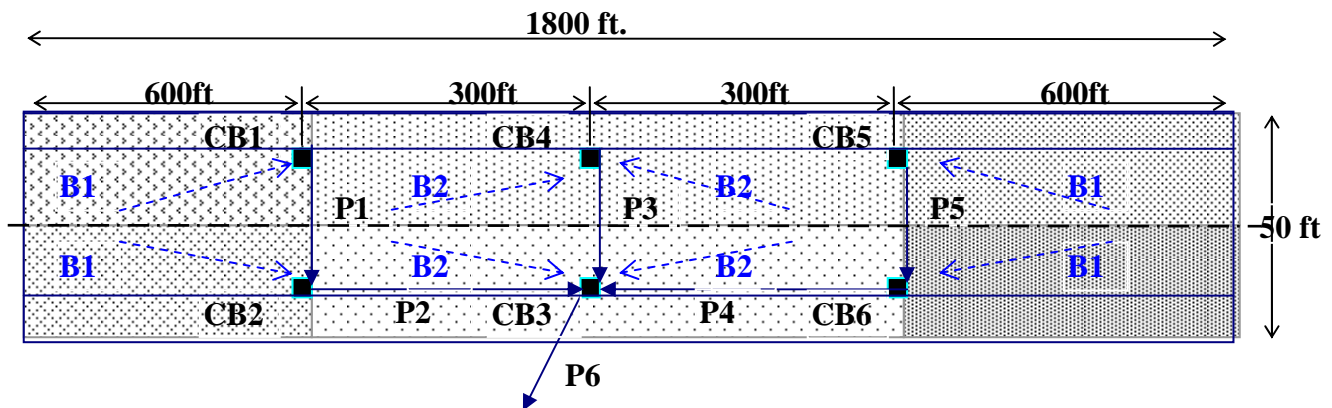

Figure 3 – PLAN VIEW

Hydraulic Report Tip – Basin calculations need to be verified by someone other than the designer. To expedite the review process, designers should provide basin calculations and plan sheets that are both clearly labeled and to scale. This label should match the name of the basin used in StormShed.

Basin Definition

Next we need to define the two drainage basins for our project. Below is the drainage basin contributing to catch basins CB1/2/5/6.

- Click on the **New** button and the default 'B1' should appear, select **OK**.
- Change the rainfall type to **EWash-3hr.rac** for EWA and **Type 1A** for WWA.
- Use **SBUH** for the Design Method.
- The Hyd Interval is **5 min** for EWA and **10 min** for WWA.
- And finally the Storm Duration is **3 hours** for EWA and **24 hours** for WWA.

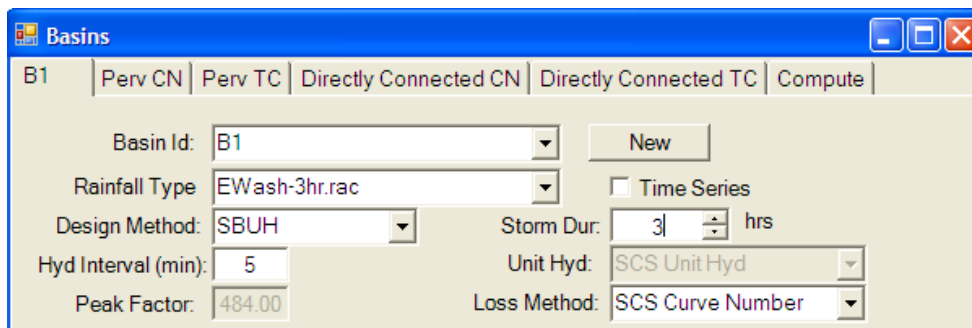

Next go to the *Perv CN* and *Perv TC* tabs.

- For this example there are no Pervious surfaces, so delete the default values on these tabs.

Description	Subarea	CN
cb area	0.344	98.00

Next select the *Directly Connected CN* tab and input the basin data as shown above.

Type	Description	Length	Slope	Coeff	TT
Sheet	Smooth Surfaces.	20.00	2.00	0.011	0.51
Shall...	Paved	600.00	1.00	0.01	4.92

Select the *Directly Connected Tc* tab to calculate the Time of Concentration for the basin.

- For the flow type select '**Sheet**' from the pull-down menu.
- The description is automatically determined when the Coefficient is selected from the pull-down menu. Find and LMB click on '**Smooth Surfaces**' in the pull-down menu.
- Type **20'** for the length (note the 5' for the sidewalk was not included, this is because we are only concerned with the longest flow path).
- Input **2%** for the slope and hit the **Add** button to add this record.
- Repeat the steps for Shallow flow and input the values shown above.

Notice the Total Tc (min) next to the gray box indicates our Tc is 5.42 min. for this basin.

- Select the **Close** button when the record for B1 is complete.

Now we will repeat the process for basin **B2**, which is contributing flow to CB3/4. In this case we only need to modify the length of shallow flow.

- The easiest way is to open basin **B1** and then select the **New** button.
- Select the default basin name of **B2** and hit **OK**.

Type	Description	Length	Slope	Coeff	TT
Sheet	Smooth Surfaces.	20.00	2.00	0.011	0.51
Shall...	Paved	300.00	1.00	0.01	2.46

Select the *Directly Connected Tc* tab.

- Highlight the Shallow flow type by clicking on the LMB.
- Double LMB click on the **600'** length and retype **300'**.
- Click on the **Update** button and the record should appear as shown above.

*Note the Total Tc (min) is now only 5 minutes, however the sum of the TT (travel time) is less than 5 minutes. In this case the basin has used the default of 5 minutes minimum for travel time in a basin that was set up in the **Project Configuration** menu.*

Creating A New Layout

Next we will create a new layout.

- To create a new Layout, click on the **Layout View** Tab and select the 'Insert Nodes and Reaches' radio button in the upper left corner.
- Input the name '**network**' for this example and select **OK**.
- The 'Fill node structures' radio button to create a solid node as shown in this tutorial and deselect the button for a outline of a box.

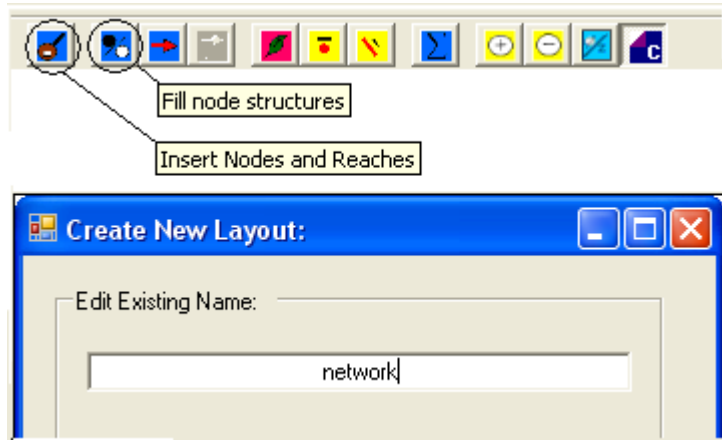

Insert Nodes and Reaches

Next we will input the network. This will be a schematic view and not to scale; however, it is important that the angles between the pipes be accurately represented since StormSHED will use these angles to calculate headloss of flow through the system.

When nodes and reaches are input into the layout view, it is important that they be entered from the most upstream node to the downstream node. The direction the nodes and reaches are input establishes the direction of flow within 3G, as shown with the flow arrows below. In order to input our layout with the correct flow direction, we will have to input our network in three steps.

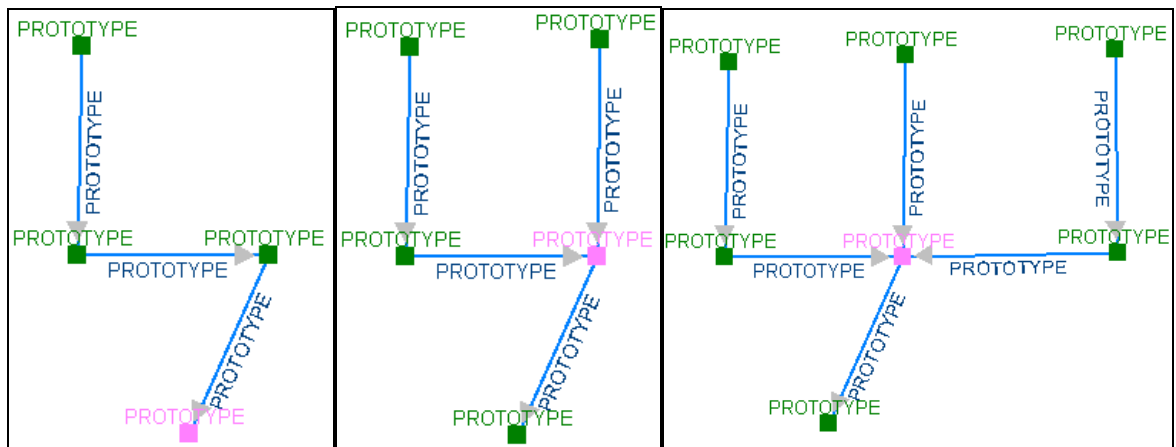

Step 1

Step 2

Step 3

- Toggle the 'insert nodes and reaches' button on and use the LMB to select the approximate location of the 4 nodes in step 1. Notice the reaches are automatically input between the nodes. Toggle off the insert button after the 4th node has been input.
- For step 2 we can only add one node and one reach. Toggle back on the 'insert nodes and reaches' button and using the LMB locate the node and reach in the approximate locations as shown in Step 2. Notice once the pink node is selected, the insert button is automatically toggled off.
- Complete the network by toggling on the radio button and inputting the network as shown in Step 3. Again the insert button will automatically toggle off once the pink node is selected.

Note every structure entered is labeled 'PROTOTYPE'. Verify the flow direction is as designed by toggling on the 'Draw Flow Direction Arrow' radio button on the top of the layout view. (The button immediately to the left can be used to fill the arrow head).

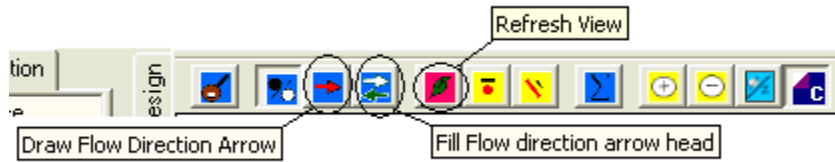

If the arrow heads are not going in the direction expected, RMB click on the reach and select 'Reverse Rch Direction'. StormShed 3G will automatically reverse the flow direction arrowhead. The process is the same to delete a node or reach only select 'Delete' from the menu. Sometimes after the layout has been modified or an existing file has been opened, it is necessary to use the 'Refresh View' button to clean up the layout. The 'Synchronize Inverts' option allows the designer to change all the downstream reach and node elevations with one click when an upstream node start elevation has been modified.

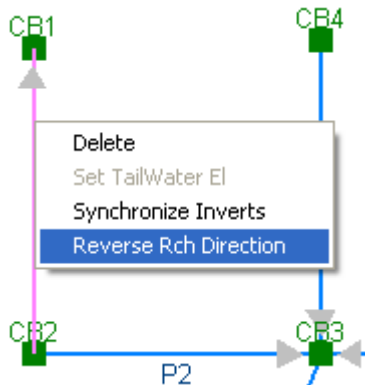

If the view is too large or small, toggle on the 'Zoom In' or 'Zoom Out' button



At the lower left corner of the layout, shows the zoom level. A zoom level of 1.5 is shown below. Also, to the right of the zoom level the name of the layout is shown as 'network'.



Define Nodes and Reaches

First we will create the nodes and reaches, and then we will define them in the *Layout View*.

Node Definition

We will use the structure information from the first page of this tutorial to create our nodes.

- Start by **double LMB clicking** on the **Prototype** node in the Tree View, the following box should appear.

The screenshot shows the 'Nodes' dialog box with the following fields and values:

- Node ID: CB1
- Description: catch basin
- Start EL(ft): 332.50
- Max EL(ft): 337.00
- Contrib Area: B1
- Contrib Hyd: (empty)
- North (ft): 0.00
- East (ft): 0.00
- Increment for rating curves: 0.10
- Void Ratio (%): 100

- Click on the new node button and accept the default name of **CB1**.
- For the description type **catch basin**.
- For Start and Max El. input the values from the table on the first page of this tutorial; **332.5** and **337**.
- Select the *Node Type* radio button for **MH/CB type**. (In other tutorials we will discuss most of the other *Node Types* in more detail).

Next select the **Contrib Drainage Area** tab. All the basins created in this project will appear.

- Select **B1** by using a single LMB click. (If you go back to the **CB1** tab, note the **Contributing Basin** box will show B1 in gray).

The screenshot shows the 'Contrib Drainage Areas' tab with a list of basins: B1, B2, and PROTOTYPE. B1 is selected.

Finally select the **MH/CB Structures** tab, this is where we will define the structure.

The screenshot shows the 'MH/CB Structures' tab with the following fields and values:

- Struct Type: CB-TYPE 1
- Condition:
 - Existing
 - As Drywell
- Structure Bottom Area (sf): 3.97
- Channelization:
 - Curved or Deflector

- From the *Struct Type* pulldown menu, select **CB-Type 1**. Notice the Structure Bottom Area (sf) is linked to the Structure Type, in this case it is **3.97**.
- Make sure the *Condition* and *Channelization* boxes are not checked. The *Condition* boxes should only be checked if this is an existing structure or a drywell. The *Channelization* should be selected when the flow line runs along the bottom of the structure without a drop as shown in our example.

Continue creating nodes using the table on the first page of this tutorial. Directions for the last node on the table are shown below:

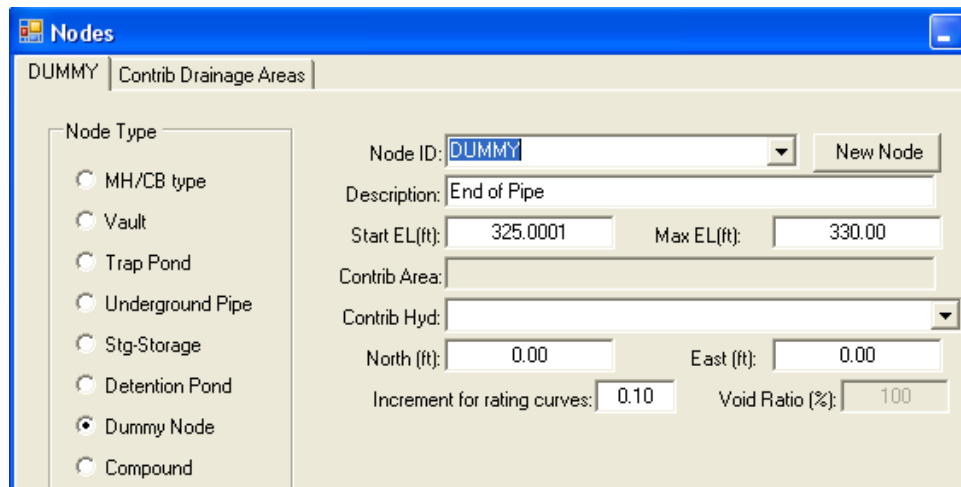

- Select **New Node** and input **DUMMY**, hit **OK**.
- For the description, type **End of Pipe**.
- Use the *Start EL(ft)* and *Max EL(ft)* in the table on page 1 of this tutorial, **325** and **330**.
- Select **OK** to accept the Node.

Reach Definition

Define the pipes using the Reach Definition from the first page of this tutorial; begin with the minimum allowed pipe diameter (12"). When StromSHED 3G routes flow through the pipe it will determine if a larger pipe is necessary. **Double LMB** click on the **Prototype Reach** in the **Data Tree View** and the following dialog box will open.

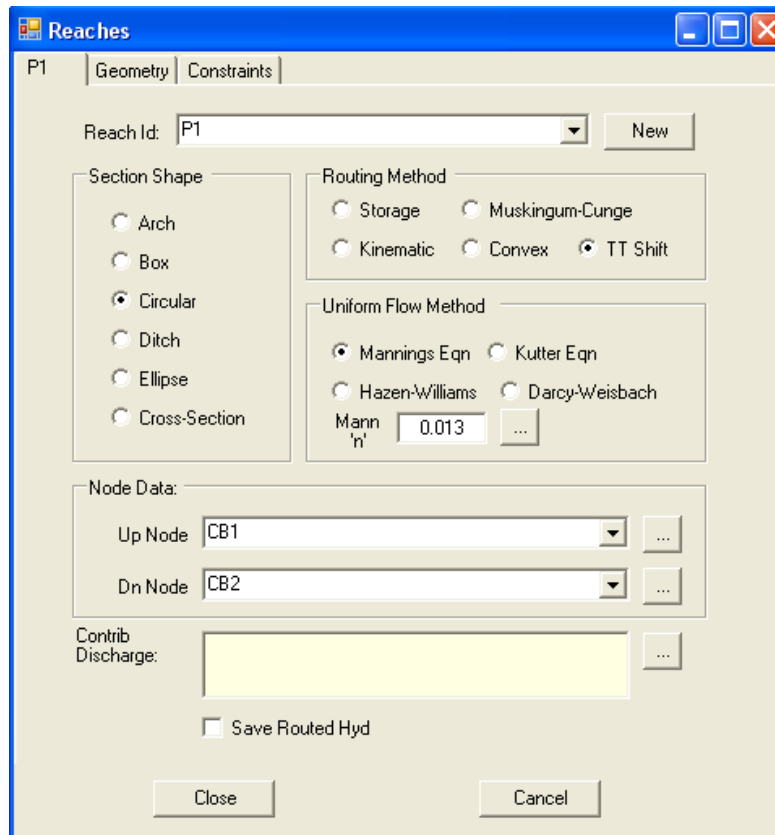

- Select **New** and accept the default of **P1**.
- For the *Section Shape*, select the **Circular** radio button.
- Routing Method, **Travel Time Shift**, most common (uses the Manning's equation) computing the velocity from the top to the bottom of each reach. Muskingum-Cunge would be the only other one we would use for very long pipes.
- **Manning's** is the most commonly used in the US and the one we will be using.

The **Constraints** tab only applies to underground conduit. Setting these values will do two things: tell the program to flag a value that falls outside the constraints after computing and when 3G sizes the system it will stay within the constraints. We will show both in more detail later in this tutorial. **Input the values shown in the Constraints tab** below, these are the constraints from the design criteria listed on the 2nd page of this tutorial. Remember if these values are saved in the **PROTOTYPE Reach**, they will be carried over to all reaches created from the PROTOTYPE and will not have to be retyped each time a reach is created.

The besides the design criteria given at the beginning of this tutorial, Constraints affecting up and down inverts, are briefly described below:

- *Min Cover* – Chapter 8 of the Hydraulics Manual requires 2’ of cover from the bottom of pavement to the top of the pipe. Determining this value will take some time. Designers will need to determine: the pavement thickness, and wall thickness of the pipe. These values should be added to the 2’ depth and that value should be input here. If 2’ of depth can not be met, designers should review the shallow cover requirements in Chapter 8 of the Hydraulics Manual.
- *Drop across MH* – this only applies to manholes. The drop refers to the distance between inverts in elevation entering and leaving a node. Checking this option, would do two things: the program would flag a greater elevation that is manually entered after using the compute command or if the program synchronized the inverts or computed diameters/slopes it would use this constraint in the design.

Exfiltration/Infiltration was explained in the ditch tutorial leave this value at **0** for this example.

The ‘*Transition constraints across node*’ applies only when 3G is going to calculate the pipe diameters/slopes or the synchronize invert option is used. We will try this later in our tutorial but for now **leave the boxes blank**.

- *Hold Up/Dn IE* – this option will hold the up or down invert elevation when using the synchronize invert option.
- *Match Inverts* – if this box is not checked, the program will align the crowns when the synchronize invert option is used.
- *Allow Smaller Conduits* – when 3G sizes

The **Geometry** tab options vary based on what was selected in the *Section Shape* on the first tab. For example, the gray boxes are only available when the ditch or x-section option is selected.

- Use the *Size* pull down menu to select **12 in diam**. This is our first guess for the pipe size, we will find out after running the design storm through the network if this size will work. This method for sizing pipe is considered the trial and error approach, as pipe sizes are modified based on the output. From 3G.
- *Entrance Losses* – the pull-down menu provides a list of different entrance losses that would best describe the shape of the pipe exiting the node. For most nodes, including this example, **Circular Conc: Square Edge w/Headwall** is the best description.

For Specific Geometry the length, slope and elevation of the pipe will be set.

- For **Length** input **36** ft.
- The **slope** should be **1.39%**, this will have to be set twice because the slope is calculated from the up and down IE or invert elevation.
- Set the **Up IE** at **332.5** ft and the **Dn IE** at **332**. At this point the slope will have to be modified again to **1.39%**.

Continue to create reaches, using the information provided in the tables on the first page of this tutorial.

Define Reaches and Nodes in Layout View

Now we need to show StormSHED the location of each node and reach.

- In the layout view double click on the upper left hand node and the node dialog box will open.
- Using the pull down menu Node ID, select CB1.
- Select Okay to close the dialog box.
- Repeat this process until all the nodes and reaches are defined.

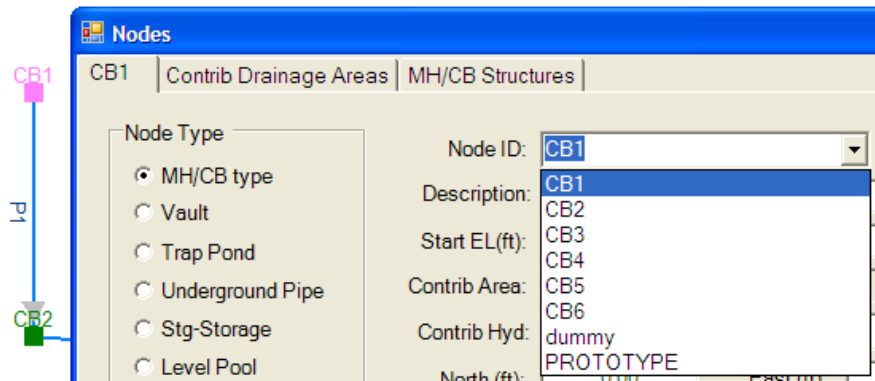

The network should appear as shown below when you are finished.

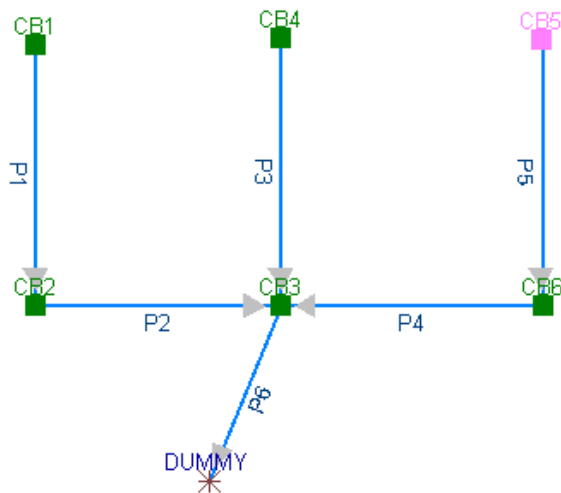

Now the network is completely entered and ready for analysis. Using the LMB, select the compute button in the layout toolbar.

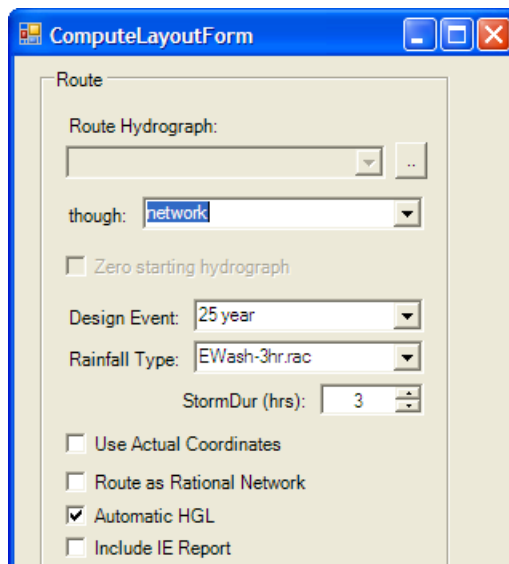

The following box should open. This is where we will define the network we are analyzing, as well as the storm that should be used to size the system.

- Select **network** from the pull down menu in the *through:* box.
- The **25 year** Design Event is used to design conveyance systems.
- The *Rainfall Type* for EWA is **EWash-3hr.rac** and for WWA **Type 1A** storm. The *Storm Duration* for EWA is **3 hours** and for WWA it is **24 hours**.
- For this example, only the **Automatic**

HGL should be checked.

- Select the **Route** button and then **Close**.
- First look at the **Layout View** for any red numbers or brackets. This would indicate the design is outside of the constraints.

Next select the **History View tab**. Go through the data and make sure all the design criteria parameters are met. Also, the outlet velocity should be compared to the velocities in **section 3-4.7 of the Hydraulics Manual** to determine if an energy dissipater is needed for outlet protection. In this case the outlet velocity from P6 (19.71 ft/sec) is high enough to warrant heavy loose riprap or a concrete splash pad for outlet protection. Designers to review section 3-4.7 of the Hydraulics Manual for the design criteria of Energy Dissipaters.

Outlet Velocity (ft/sec)	Material
6-10	Quarry Spalls
10-15	Light Loose Riprap
>15	Heavy Loose Riprap

Designers should provide geotextile or filter material between any outlet material and the existing ground for soil stabilization, see section 4-6.3.2 for information..

Outlet Protection Material Size
Figure 3-4.7.1

Creating a Report

Remember only the last record sent to the **History View** is retained, so once the final compute has been run copy the output and paste it into a word processing program. The history view should appear as shown below.

Appended on: Friday, January 18, 2008 2:35:07 PM

ROUTEHYD [] THRU [network] USING [25 year] AND [EWash-3hr.rac] NOTZERO RELATIVE SCS/SBUH

Gravity Analysis using 3 hr duration storm

Reach ID	Area (ac)	Flow (cfs)	Full Q (cfs)	Full ratio	nDepth (ft)	Depth ratio	Size	nVel (ft/s)	fVel (ft/s)	Infil Vol (cf)	CBasin / Hyd
P5	0.344	0.5951	3.2546	0.1829	0.2897	0.2897	12 in Diam	3.1526	4.1439	0.00	B1
P4	0.688	1.1902	4.3898	0.2711	0.3557	0.3557	12 in Diam	4.7528	5.5893	0.00	B1
P3	0.344	0.6054	4.2118	0.1437	0.2557	0.2557	12 in Diam	3.82	5.3626	0.00	B2
P1	0.344	0.5951	4.2118	0.1413	0.2536	0.2536	12 in	3.798	5.3626	0.00	B1

							Diam				
P2	0.688	1.1902	2.9241	0.407	0.4445	0.4445	12 in Diam	3.5289	3.7231	0.00	B1
P6	2.064	3.5913	20.6242	0.1741	0.2819	0.2819	12 in Diam	19.7595	26.2595	0.00	B2

HGL Analysis

From Node	To Node	HG El (ft)	App (ft)	Bend (ft)	Junct Loss (ft)	Adjusted HG El (ft)	Max El (ft)
							325.8094
CB3	dummy	331.7355	0.0357	0.0320	0.0253	331.7571	336.0000
CB6	CB3	335.1517	0.1543	0.2093	-----	335.2067	338.5000
CB5	CB6	335.8279	-----	-----	-----	335.8279	338.5000
CB4	CB3	333.5387	-----	-----	-----	333.5387	336.0000
CB2	CB3	332.6559	0.2240	0.2764	-----	332.7084	337.0000
CB1	CB2	332.9358	-----	-----	-----	332.9358	337.0000

Conduit Notes

Reach	HW Depth (ft)	HW/D ratio	Q (cfs)	TW Depth (ft)	Dc (ft)	Dn (ft)	Comment
P-006	1.7355	1.7355	3.59	0.8089	0.8089	0.2819	SuperCrit flow, Inlet end controls
P-004	0.6517	0.6517	1.19	1.7912	0.4599	0.3557	SuperCrit flow, Inlet end controls
P-005	0.7983	0.7983	0.60	0.8664	0.3208	0.2897	Outlet Control M1 Backwater
P-003	1.8132	1.8132	0.61	1.7918	0.3236	0.2557	Outlet Control
P-002	0.6559	0.6559	1.19	1.7880	0.4599	0.4445	SuperCrit flow, Inlet end controls
P-001	0.7232	0.7232	0.60	0.9232	0.3208	0.2536	Outlet Control M1 Backwater

To make your hydraulic report complete, you will also need to include the basin, reach and node information and a picture of the layout. This information will need to be sent to the **History View** and copied into a word processing document.

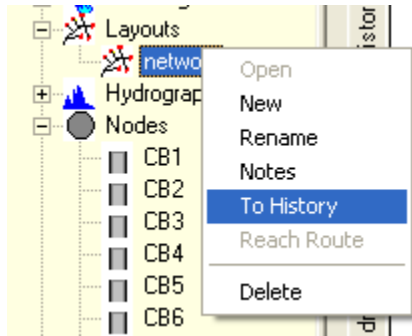

- In the *Data Tree View* click on the name of the layout (**network**) with the LMB.
- Select **To History** and all the records in that layout will be sent to the History View.

Appended on: Friday, January 18, 2008 2:47:10 PM

Layout Report: network

Event	Precip (in)
6 month	0.34
10 year	0.75
25 year	0.93
2 year 24 hour	1.40

Reach Records

Record Id: P-001

Section Shape:	Circular		
Uniform Flow Method:	Manning's	Coefficient:	0.013
Routing Method:	Travel Time Shift	Contributing Hyd	
DnNode	cb2	UpNode	cb1
Material	unspecified	Size	12 in Diam
Ent Losses	Square Edge w/Headwall		
Length	36.00 ft	Slope	1.39%
Up Invert	332.50 ft	Dn Invert	331.9996 ft
Conduit Constraints			
Min Vel	Max Vel	Min Slope	Max Slope
3.00 ft/s	10.00 ft/s	0.50%	5.00%
		Min Cover	3.00 ft
Drop across MH	0.00 ft	Ex/Infil Rate	0.00 in/hr

Record Id: P-002

Section Shape:	Circular
-----------------------	----------

Uniform Flow Method:	Manning's	Coefficient:	0.013
Routing Method:	Travel Time Shift	Contributing Hyd	
DnNode	cb3	UpNode	cb2
Material	unspecified	Size	12 in Diam
Ent Losses	Square Edge w/Headwall		
Length	298.00 ft	Slope	0.67%
Up Invert	332.00 ft	Dn Invert	330.0034 ft
Conduit Constraints			
Min Vel	Max Vel	Min Slope	Max Slope
3.00 ft/s	10.00 ft/s	0.50%	5.00%
Drop across MH	0.00 ft	Ex/Infil Rate	0.00 in/hr

Record Id: P-003

Section Shape:	Circular		
Uniform Flow Method:	Manning's	Coefficient:	0.013
Routing Method:	Travel Time Shift	Contributing Hyd	
DnNode	cb3	UpNode	cb4
Material	unspecified	Size	12 in Diam
Ent Losses	Groove End w/Headwall		
Length	36.00 ft	Slope	1.39%
Up Invert	330.50 ft	Dn Invert	329.9996 ft
Conduit Constraints			
Min Vel	Max Vel	Min Slope	Max Slope
3.00 ft/s	10.00 ft/s	0.50%	5.00%
Drop across MH	0.00 ft	Ex/Infil Rate	0.00 in/hr

Record Id: P-004

Section Shape:	Circular		
Uniform Flow Method:	Manning's	Coefficient:	0.013
Routing Method:	Travel Time Shift	Contributing Hyd	
DnNode	cb3	UpNode	cb6
Material	unspecified	Size	12 in Diam
Ent Losses	Square Edge w/Headwall		
Length	298.00 ft	Slope	1.51%

Up Invert	334.50 ft	Dn Invert	330.0002 ft
Conduit Constraints			
Min Vel	Max Vel	Min Slope	Max Slope
3.00 ft/s	10.00 ft/s	0.50%	5.00%
Drop across MH		0.00 ft	Ex/Infil Rate
			0.00 in/hr

Record Id: P-005

Section Shape:	Circular		
Uniform Flow Method:	Manning's	Coefficient:	0.013
Routing Method:	Travel Time Shift	Contributing Hyd	
DnNode	cb6	UpNode	cb5
Material	unspecified	Size	12 in Diam
Ent Losses	Square Edge w/Headwall		
Length	36.00 ft	Slope	0.83%
Up Invert	334.80 ft	Dn Invert	334.5012 ft
Conduit Constraints			
Min Vel	Max Vel	Min Slope	Max Slope
3.00 ft/s	10.00 ft/s	0.50%	5.00%
Drop across MH		0.00 ft	Ex/Infil Rate
			0.00 in/hr

Record Id: P-006

Section Shape:	Circular		
Uniform Flow Method:	Manning's	Coefficient:	0.013
Routing Method:	Travel Time Shift	Contributing Hyd	
DnNode	dummy	UpNode	cb3
Material	unspecified	Size	12 in Diam
Ent Losses	Square Edge w/Headwall		
Length	15.00 ft	Slope	33.33%
Up Invert	330.00 ft	Dn Invert	325.0005 ft
Conduit Constraints			
Min Vel	Max Vel	Min Slope	Max Slope
3.00 ft/s	10.00 ft/s	0.50%	5.00%
Drop across MH		0.00 ft	Ex/Infil Rate
			0.00 in/hr

*Node Records***Record Id: CB1**

Descrip:	catch basin	Increment	0.10 ft
Start El.	332.50 ft	Max El.	337.00 ft
Void Ratio	100.00		
Condition	Proposed	Structure Type	CB-TYPE 1
Ent Ke	Groove End w/Headwall (ke=0.20)	Channelization	Curved or Deflector
Catch	0.00 ft	Bottom Area	3.97 sf
MH/CB Type Node			

Record Id: CB2

Descrip:	catch basin	Increment	0.10 ft
Start El.	332.00 ft	Max El.	337.00 ft
Void Ratio	100.00		
Condition	Proposed	Structure Type	CB-TYPE 1
Ent Ke	Groove End w/Headwall (ke=0.20)	Channelization	Curved or Deflector
Catch	0.00 ft	Bottom Area	3.97 sf
MH/CB Type Node			

Record Id: CB3

Descrip:	catch basin	Increment	0.10 ft
Start El.	330.00 ft	Max El.	336.00 ft
Void Ratio	100.00		
Condition	Proposed	Structure Type	CB-TYPE 1
Ent Ke	Groove End w/Headwall (ke=0.20)	Channelization	Curved or Deflector
Catch	0.00 ft	Bottom Area	3.97 sf
MH/CB Type Node			

Record Id: CB4

Descrip:	catch basin	Increment	0.10 ft
Start El.	330.50 ft	Max El.	336.00 ft
Void Ratio	100.00		
Condition	Proposed	Structure Type	CB-TYPE 1
Ent Ke	Groove End w/Headwall (ke=0.20)	Channelization	Curved or Deflector
Catch	0.00 ft	Bottom Area	3.97 sf
MH/CB Type Node			

Record Id: CB5

Descrip:	catch basin	Increment	0.10 ft
Start El.	334.80 ft	Max El.	338.50 ft
Void Ratio	100.00		
Condition	Proposed	Structure Type	CB-TYPE 1
Ent Ke	Groove End w/Headwall (ke=0.20)	Channelization	Curved or Deflector
Catch	0.00 ft	Bottom Area	3.97 sf
MH/CB Type Node			

Record Id: CB6

Descrip:	catch basin	Increment	0.10 ft
Start El.	334.50 ft	Max El.	338.50 ft
Void Ratio	100.00		
Condition	Proposed	Structure Type	CB-TYPE 1
Ent Ke	Groove End w/Headwall (ke=0.20)	Channelization	Curved or Deflector
Catch	0.00 ft	Bottom Area	3.97 sf
MH/CB Type Node			

Contributing Drainage Areas

Record Id: B1

Design Method	SBUH	Rainfall type	EWash-3hr.rac
Hyd Intv	5.00 min	Peaking Factor	484.00
Storm Duration	3.00 hrs	Abstraction Coeff	0.20
Pervious Area	0.00 ac	DCIA	0.344 ac
Pervious CN	0.00	DC CN	98.00
Pervious TC	0.00 min	DC TC	5.4248 min

DCI - CN Calc

Description	SubArea	Sub cn
cb area	0.344 ac	98.00
DC Compositd CN (AMC 2)		98.00

DCI - TC Calc

Type	Description	Length	Slope	Coeff	Misc	TT
Sheet	Smooth Surfaces.	20.00 ft	2.0%	0.011	0.00 in	0.5055 min
Shallow	Paved	600.00 ft	1.0%	0.01		4.9193 min
Pervious TC						5.4248 min

Record Id: B2

Design Method	SBUH	Rainfall type	EWash-3hr.rac			
Hyd Intv	5.00 min	Peaking Factor	484.00			
Storm Duration	3.00 hrs	Abstraction Coeff	0.20			
Pervious Area	0.00 ac	DCIA	0.344 ac			
Pervious CN	0.00	DC CN	98.00			
Pervious TC	0.00 min	DC TC	5.00 min			
DCI - CN Calc						
Description		SubArea		Sub cn		
cb area		0.344 ac		98.00		
DC Compositd CN (AMC 2)				98.00		
DCI - TC Calc						
Type	Description	Length	Slope	Coeff	Misc	TT
Sheet	Smooth Surfaces.	20.00 ft	2.0%	0.011	0.00 in	0.5055 min
Shallow	Paved	300.00 ft	1.0%	0.01		2.4596 min
Pervious TC						2.9651 min

Print Layout

Last we will print a copy of the layout we created.



- First use the *'Toggle Node Label'* and *'Toggle Reach Label'* buttons until the node and reach names are shown on the next page.
- Then click on the *'Select Area for Clipboard'* radio button.
- LMB click in the upper left portion of the layout and drag a window around the layout. Release the LMB to accept the 2nd point.
- Open the word processing program you are using and use the **'Paste' (or Ctrl V)** command to insert the layout. It should appear as shown in the following figure.

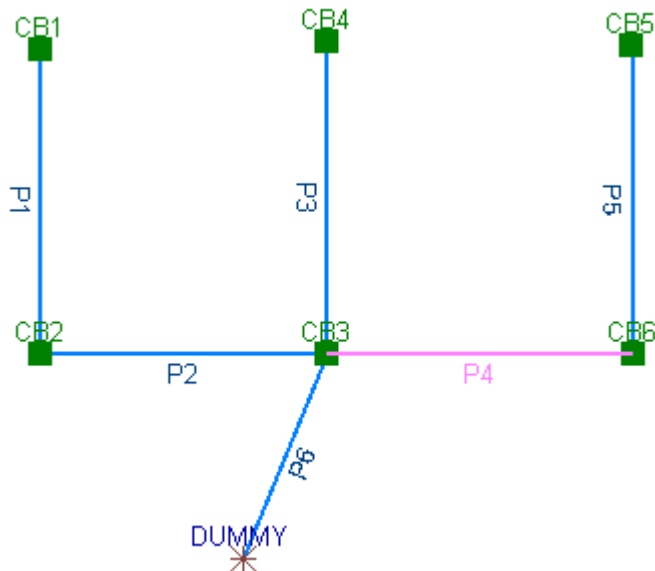

Other Options for Pipe Sizing

There are 2 other options for sizing pipe; the first involves using the Calculator located at:

Misc>Calculator

When the calculator shown below opens, select the *Pipe Calc* tab.

- Leave the *Select Reach* box empty (or a reach that has already been created can be selected from the pull down menu).
- Input the values shown in the diameter, Manning's n, Slope, and Flow (use the flow from the basin compute option with the 25 year) boxes shown below. The gray boxes are automatically calculated based on the values input. Review the data to determine what pipe size is required, for this example a 12 in diameter pipe will work.

Calculators	
Flow Profiles Swale Calc Pipe Calc	
Select Reach	<input type="text"/>
<input type="button" value="Update Reach"/>	
Diameter (in)	12.00
Velocity (fps)	3.7869
Manning's n	0.01300
Hyd Radius	0.1479
Slope (%)	1.3900
Normal Depth (ft)	0.2525
Flow (cfs)	0.59
Crit Depth (ft)	0.3193
Full Q (cfs)	4.2118
Area (sf)	0.1558
Full Vel (fps)	5.3626
Wetted Perim (ft)	1.0532
Top Width (ft)	0.869

Zero Slopes/Diameters

Another option is to allow 3G to compute the diameters and slopes.

- After the network is complete, select the 'Zero Slopes/Diams' button. This will set all the reach diameters and slopes to zero. (If you are planning to have 3G set the diameters and slopes, set them to zero when creating the reaches).

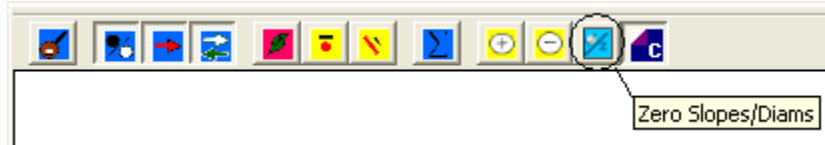

- Select 'Clear Slopes' and 'Clear Diameters' by LMB clicking in the boxes.
- Highlight the Reaches shown by holding down and dragging the LMB over the reaches.
- Hit the **Clear** button and the box will automatically close.

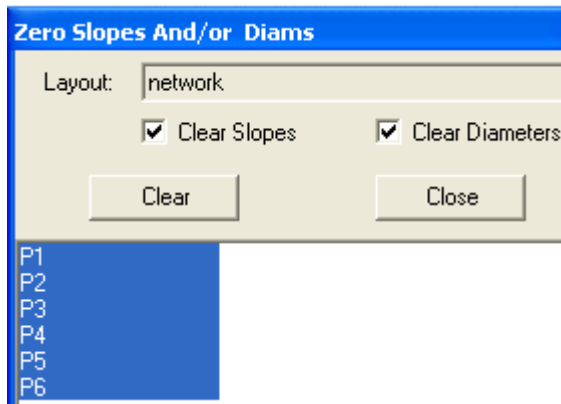

- Open reach P6 and go to the **Constraints** tab. Check the *Hold Dn IE* box. This will hold the elevation for the pipe outlet that we set earlier.

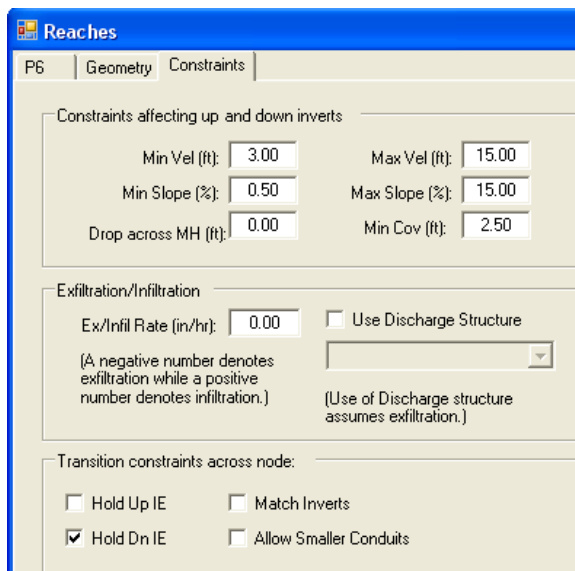

- In the **Layout View**, select the **Compute** button. Select the **Route** button to size the pipes and slopes. **Toggle** through the Reach labels to see what the new diameters and slopes.