

2018 Ramp & Roadway



Washington State Department of
Transportation

Northwest Region
Data Station Reference Guide

Table of Contents

I-5.....	3
SR 18.....	34
I-90.....	41
SR 99.....	50
SR 167.....	53
I-405.....	59
SR 509.....	75
SR 518.....	79
SR 520.....	82
SR 522.....	88
SR 525.....	92
SR 526.....	94
SR 599.....	96



Pierce County Line

S 375TH ST

Federal Way WeighStn

Enchanted PKWY

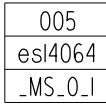
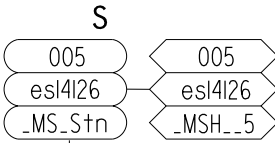
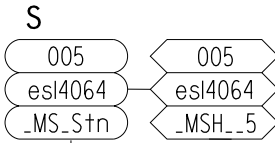
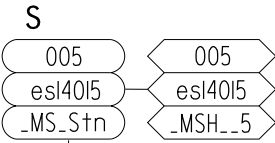
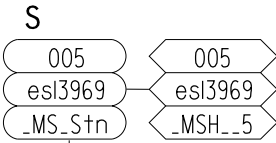

WEIGH STATION

WEIGH STATION

REST AREA

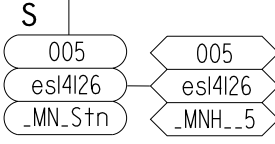
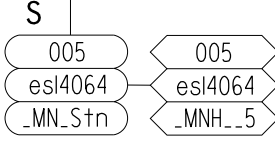
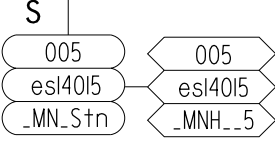
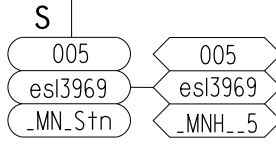
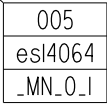
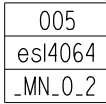

Washington State Department of Transportation



1 OF 31

EXIT 142A\B
SR 18

EXIT 143
S 320TH ST

S 317TH ST
PARK & RIDE
DIRECT ACCESS
S 308TH ST

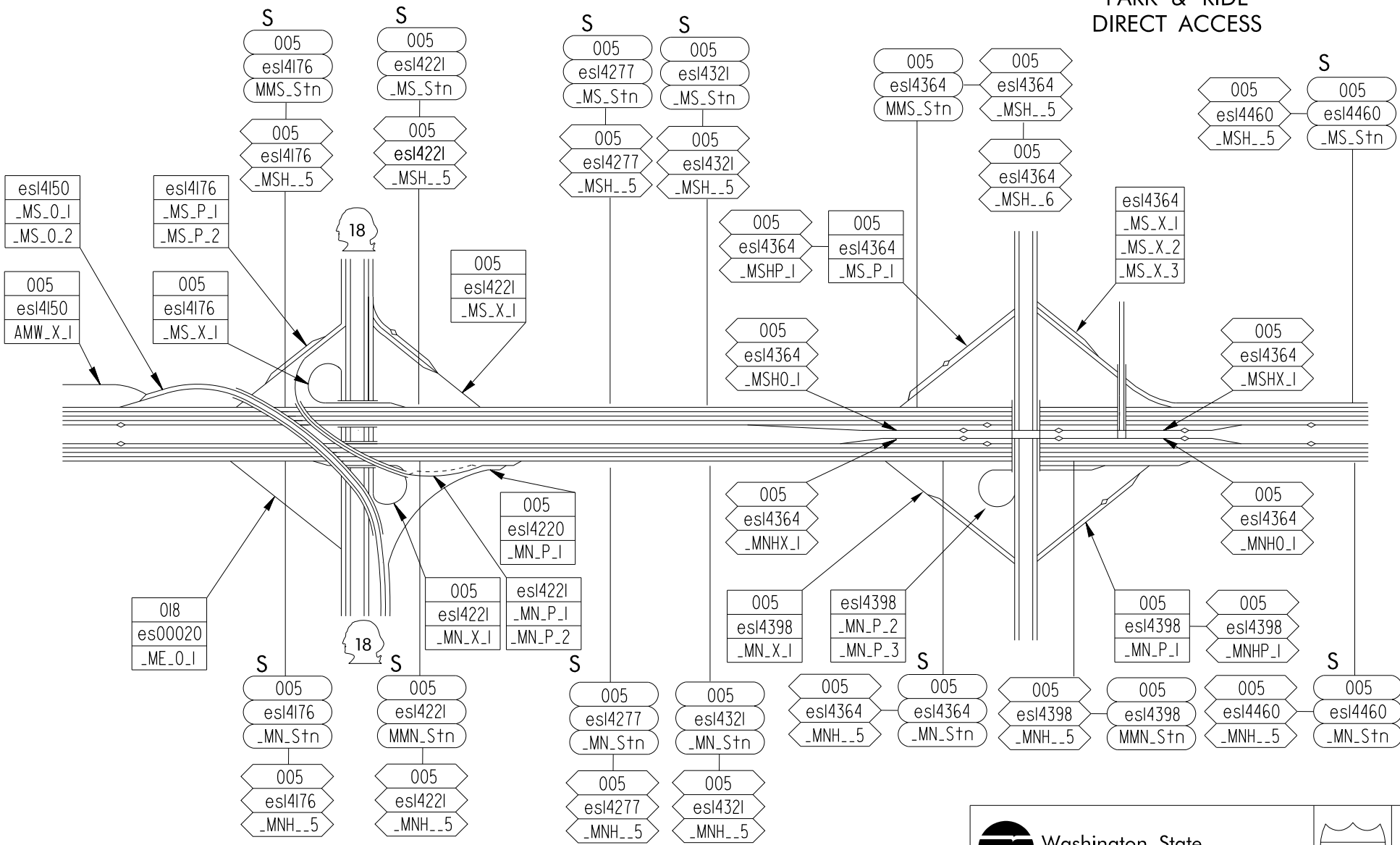

Washington State
Department of Transportation



2
OF
31

S 298TH ST

S 288TH ST

S 282ND ST

EXIT 147

S 272ND ST

S 266TH ST

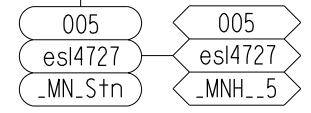
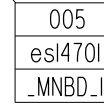
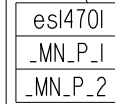
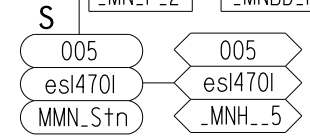
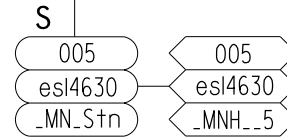
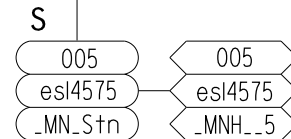
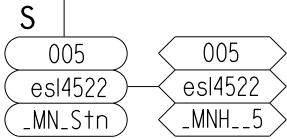
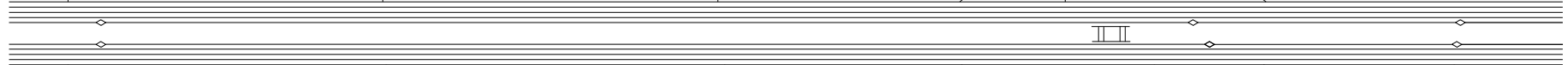
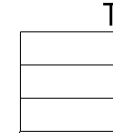
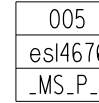
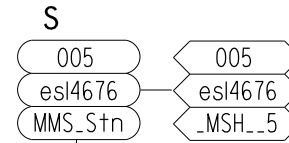
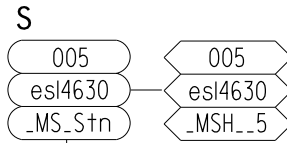
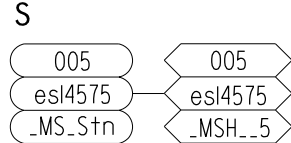
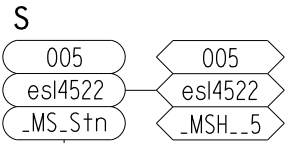

Washington State
Department of Transportation



3
OF
31

EXIT 149AB

SR 516

S 260TH ST

S 252ND ST

S 243RD ST

S 216TH ST

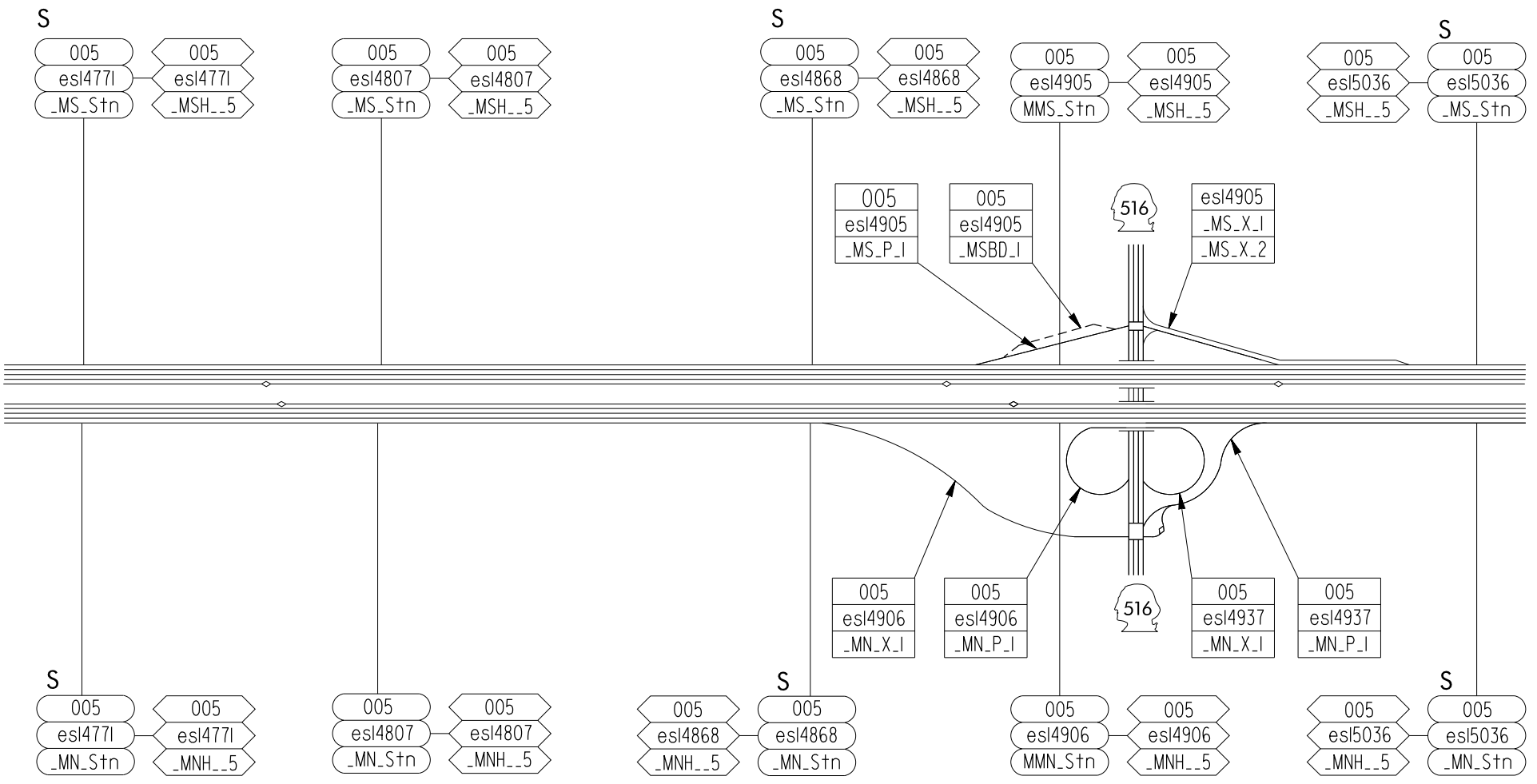

Washington State Department of Transportation



4 OF 31



EXIT 151
S 200TH ST
MILITARY RD

EXIT 152
S 188TH ST
ORILLIA RD

S 184TH ST

S 178TH ST

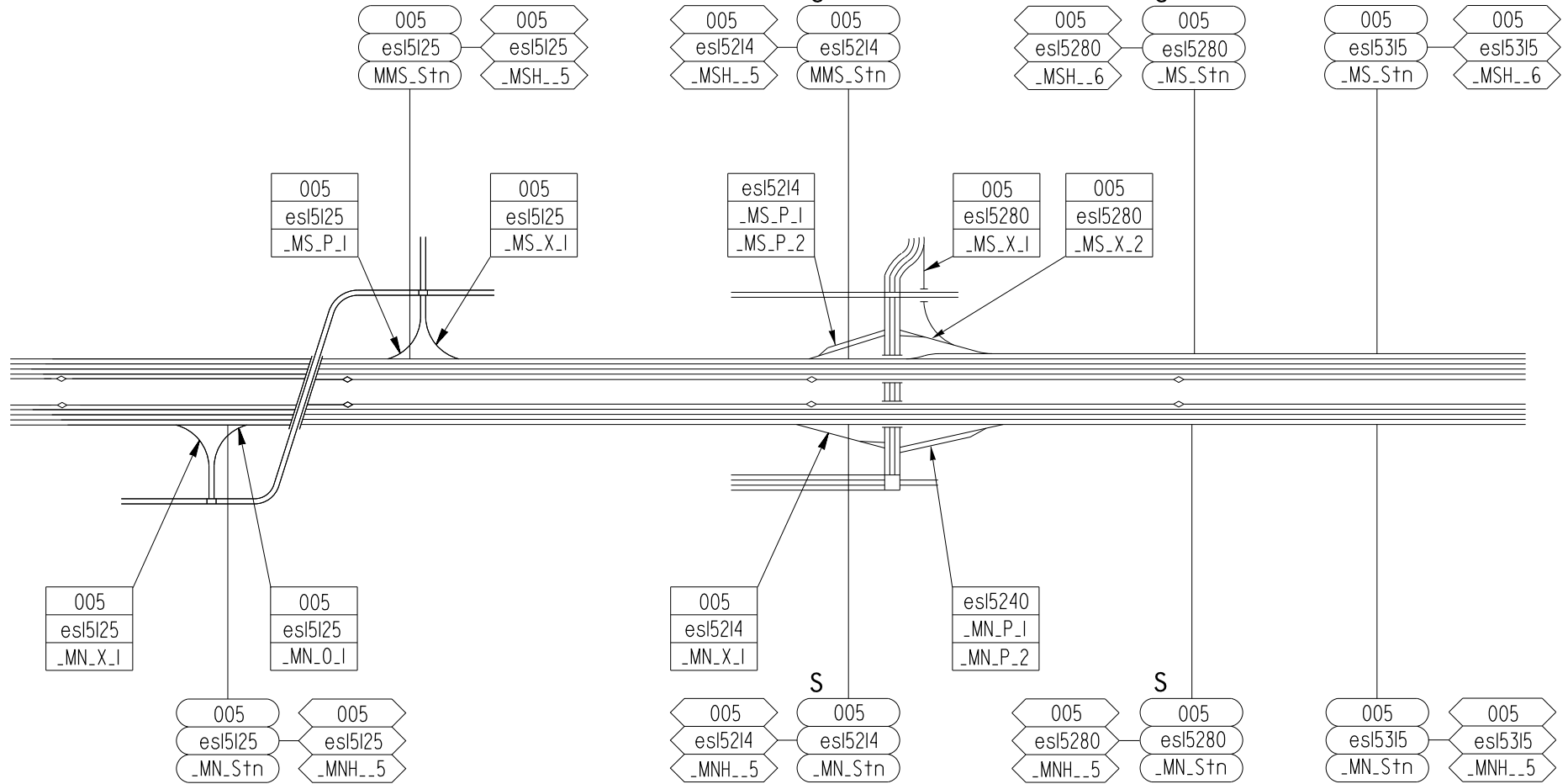

S 172ND ST

EXIT 154A
KLICKITAT DR
SOUTHCENTER PKWY

EXIT 154A/B
SR 518
I-405

EXIT 154B
S 154TH ST
SOUTHCENTER BLVD

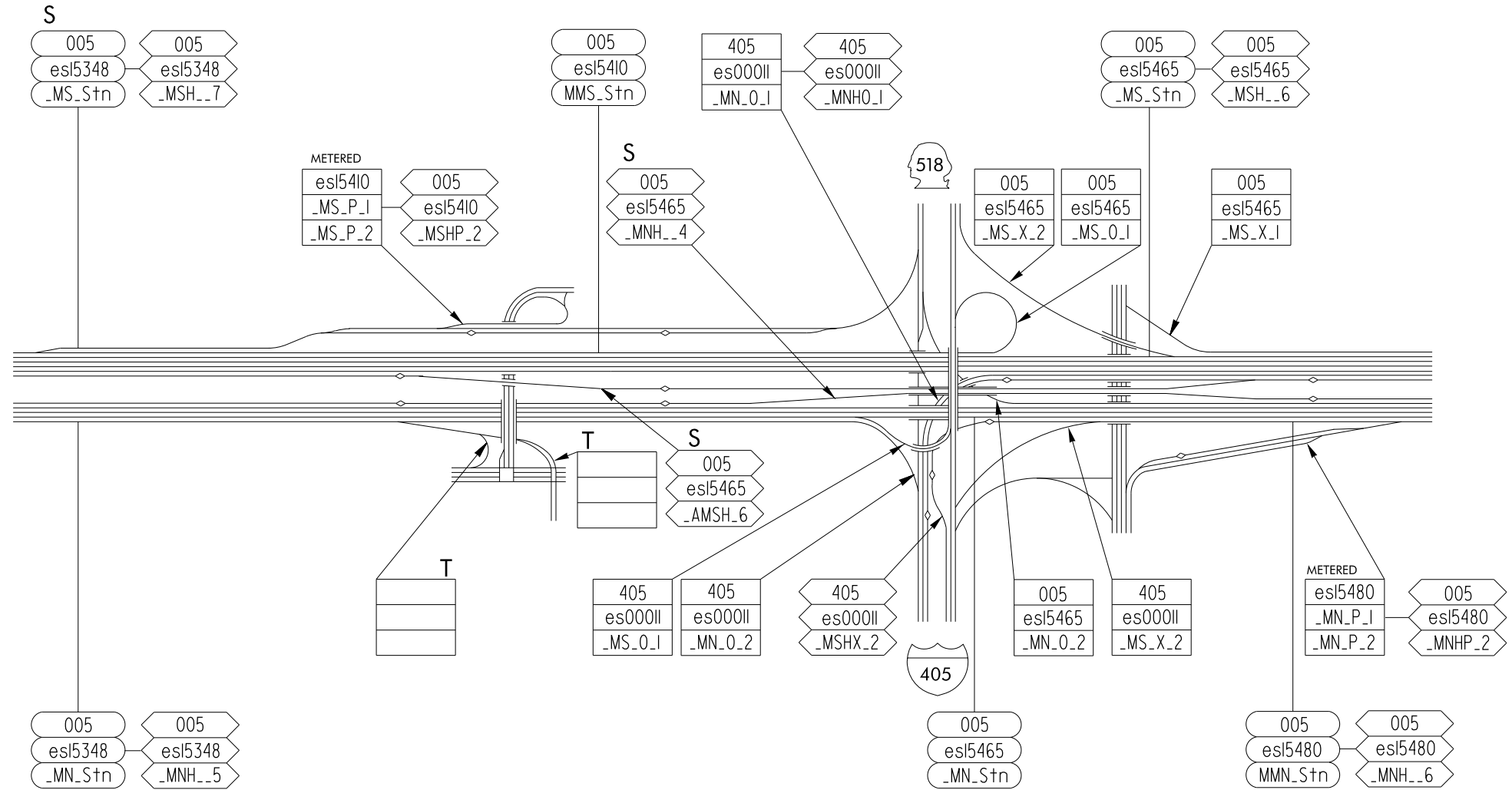

S 144TH ST

EXIT 156
SR 599

EXIT 156
INTERURBAN
AVE

S 129TH ST

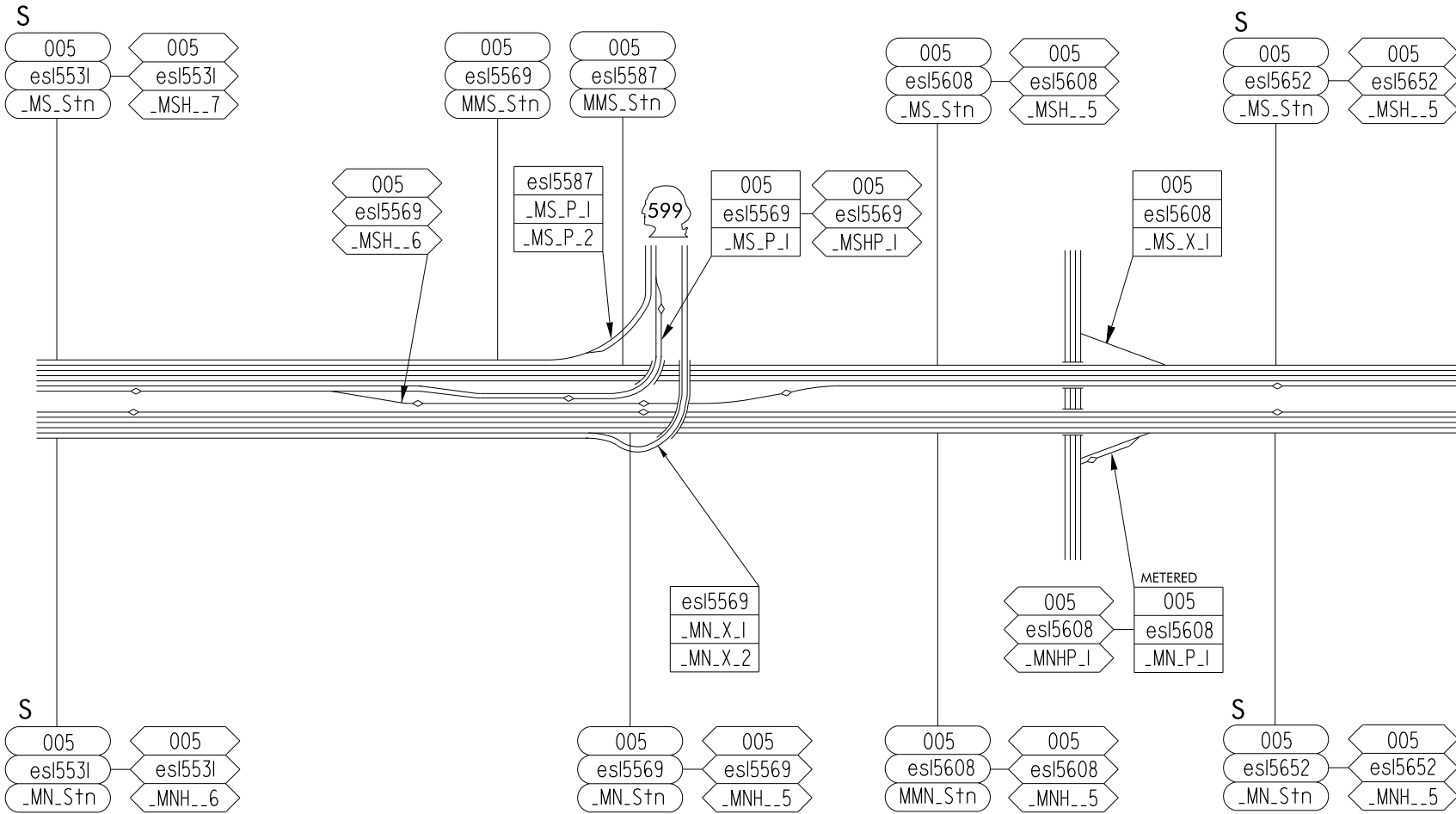

EXIT 157
SR 900
M L KING JR WAY S

EXIT 158
S BOEING
ACCESS RD

S NORFOLK ST

S BENEFIT ST

S THISTLE ST

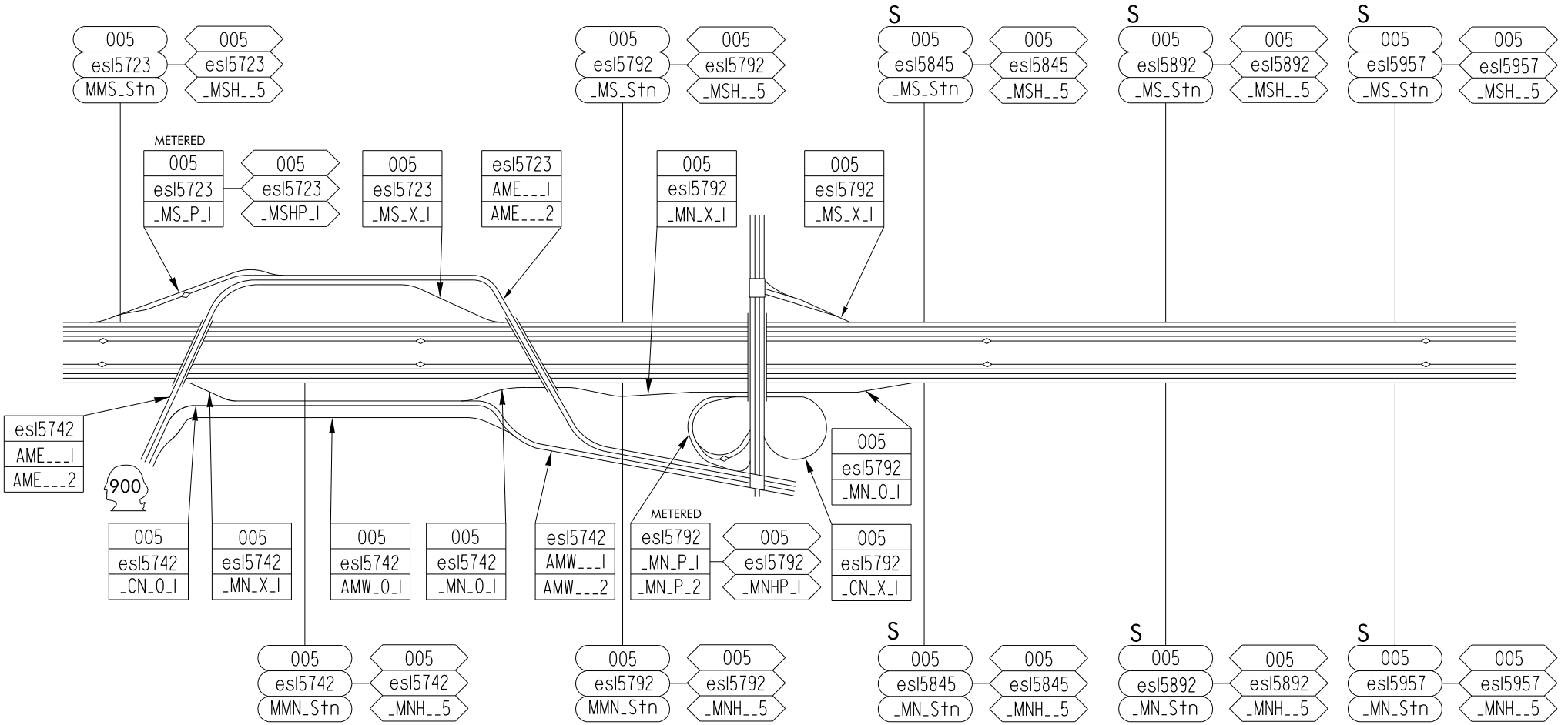



S Holden ST

S Holly ST

EXIT 161
ALBRO PL
SWIFT AVE S

EXIT 162
CORSON AVE S
S MICHIGAN ST

S Pearl ST

S OREGON ST

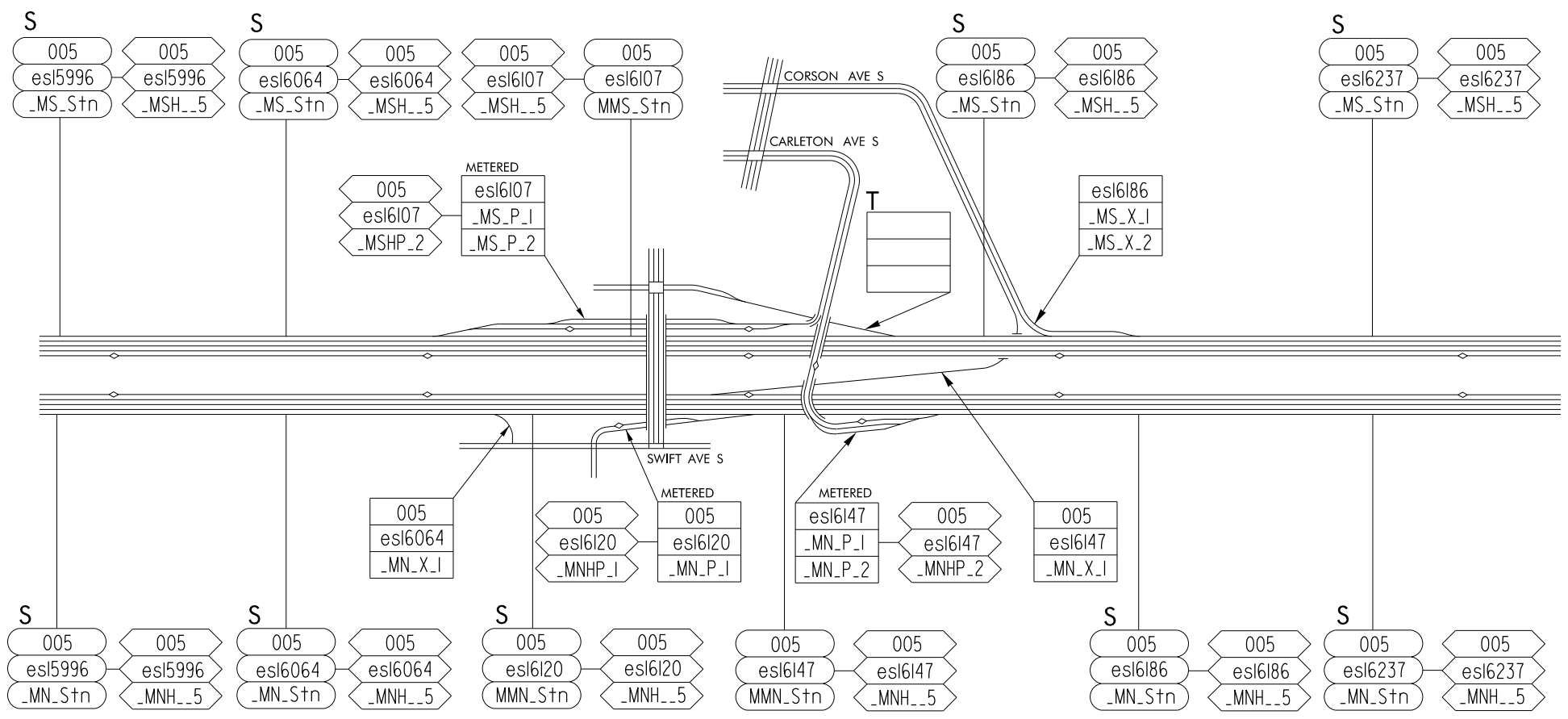

EXIT 163/163A
 S SPOKANE ST
 COLUMBIAN WY
 W SEATTLE BR

EXIT 163B
 S FOREST ST

S HOLGATE ST

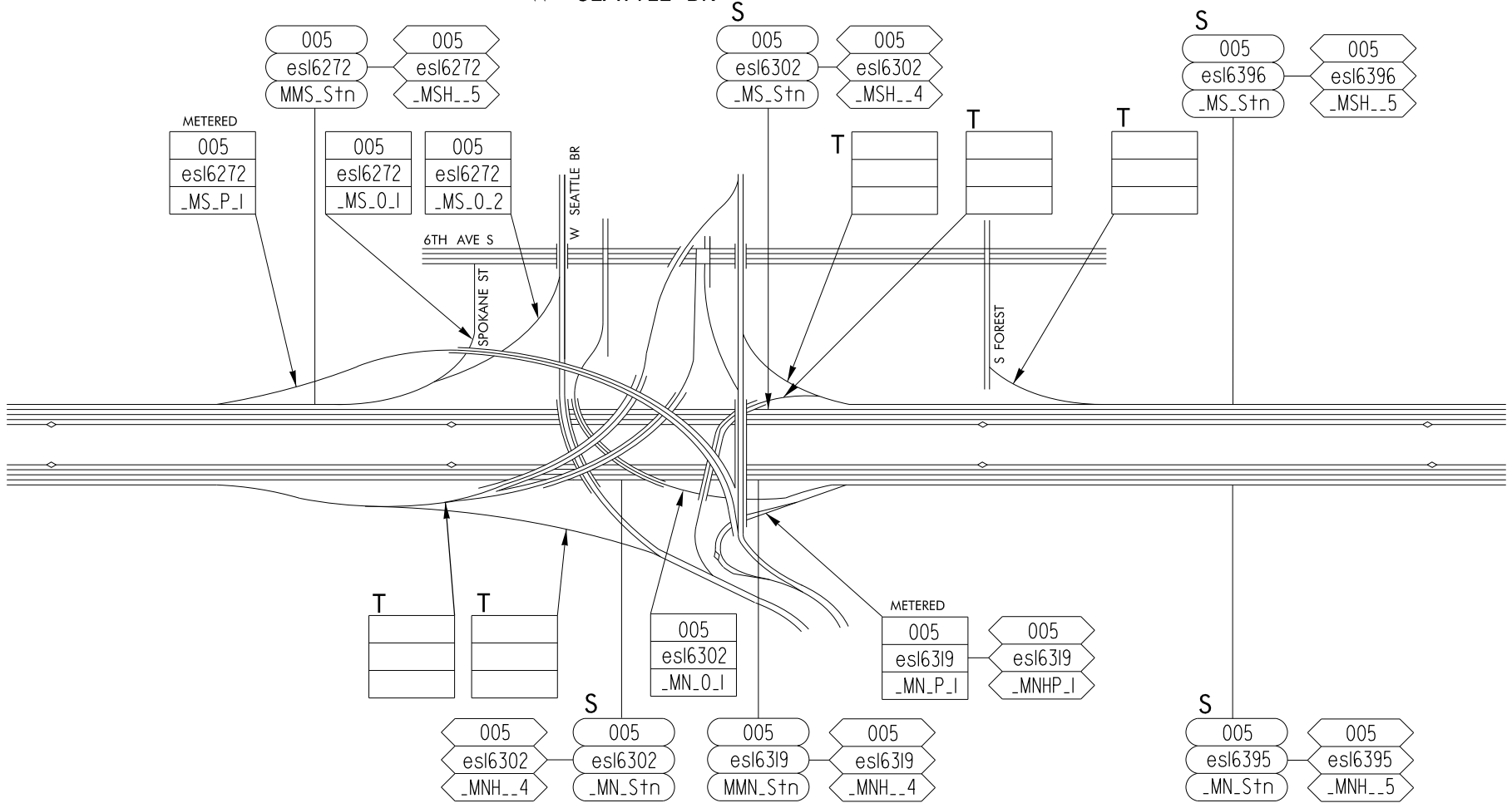

EXIT 164A
COLLECTOR-DISTRIBUTOR

EXIT 164B
4TH AVE S DEARBORN ST

YESLER WAY

JAMES ST

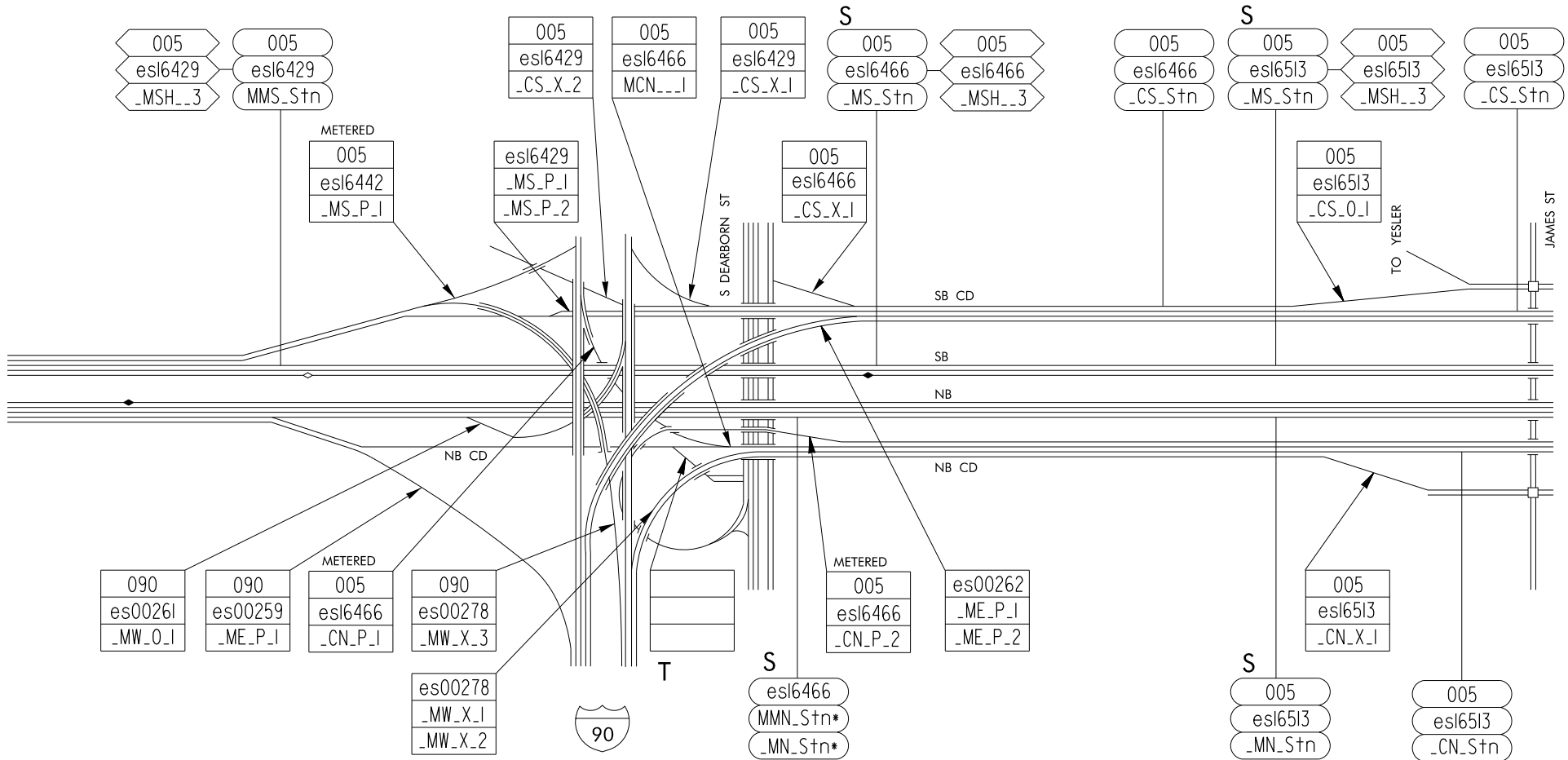

* esl6466_MMN_Stn includes only lanes 1 and 2 for metering purposes.
*_MN_Stn includes only lanes 3 and 4.



Washington State
Department of Transportation



CHERRY ST

MADISON ST

UNIVERSITY ST

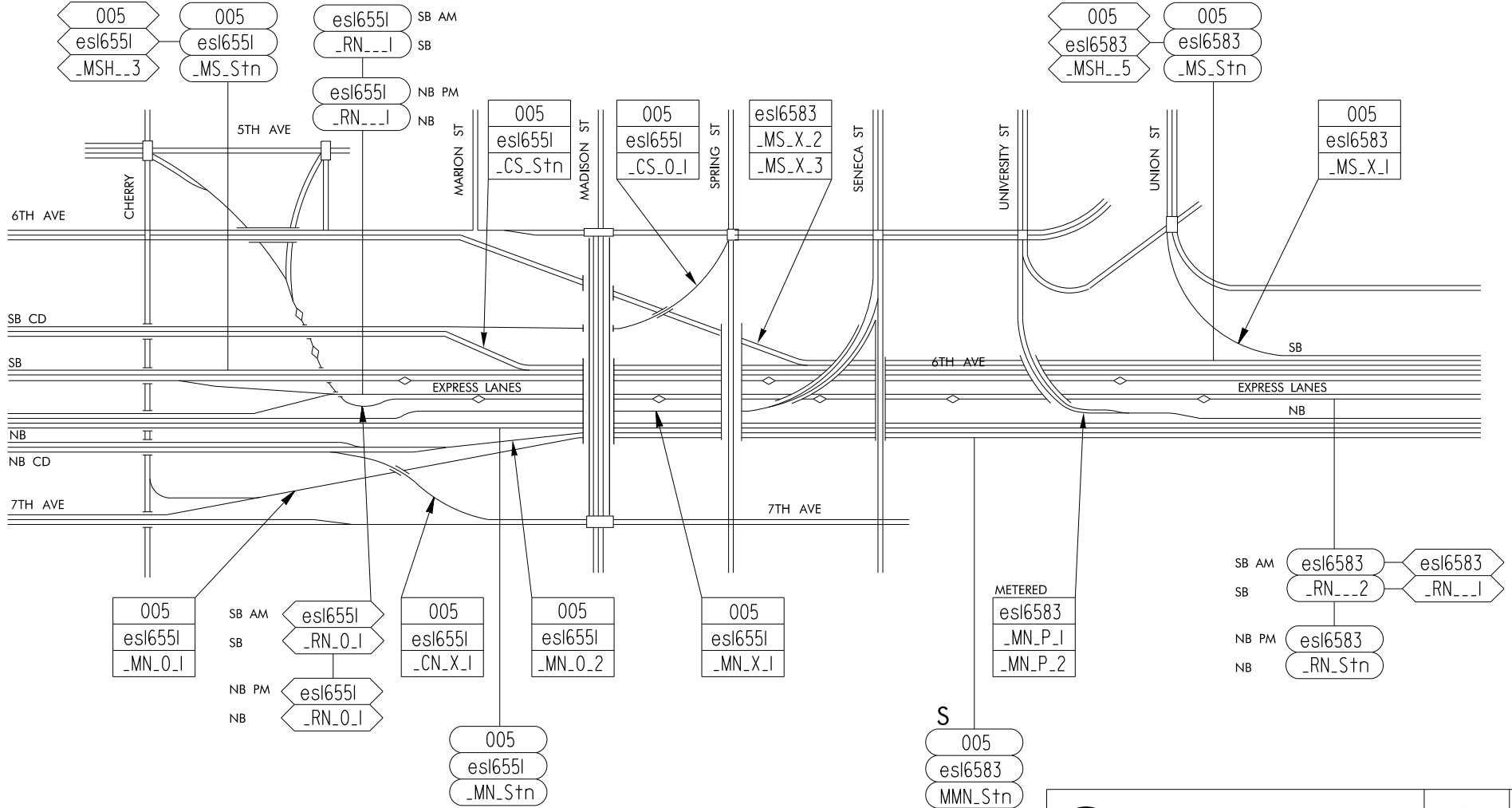

EXIT 166
DENNY WAY

EXIT 167
MERCER ST

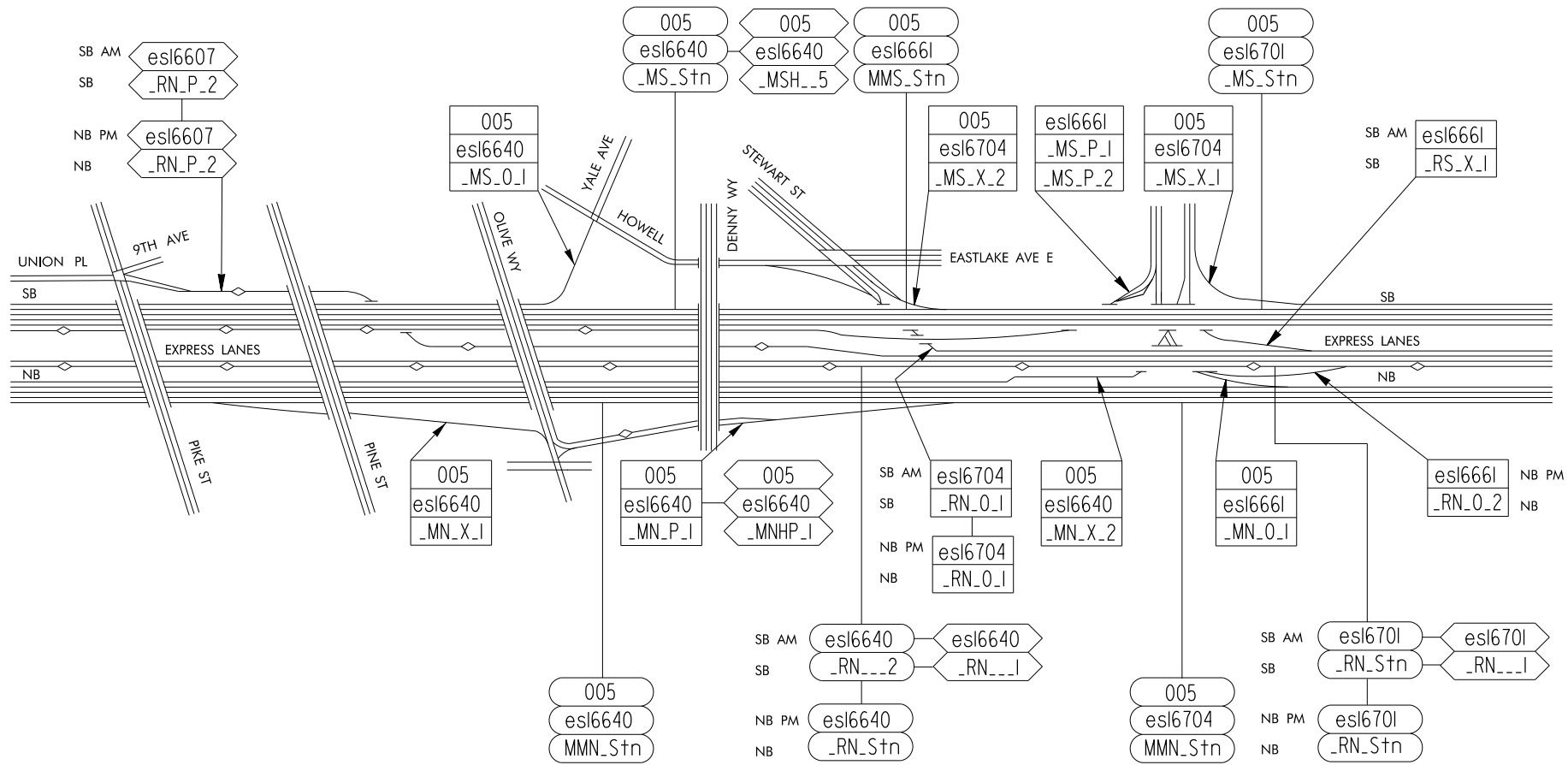

E GALER ST

EXIT 168A
BOYLSTON AVE
LAKEVIEW BLVD

EXIT 168B
ROANOKE ST
SR 520

EXIT 168A
HARVARD AVE
ROANOKE ST

SHIP CANAL
BRIDGE

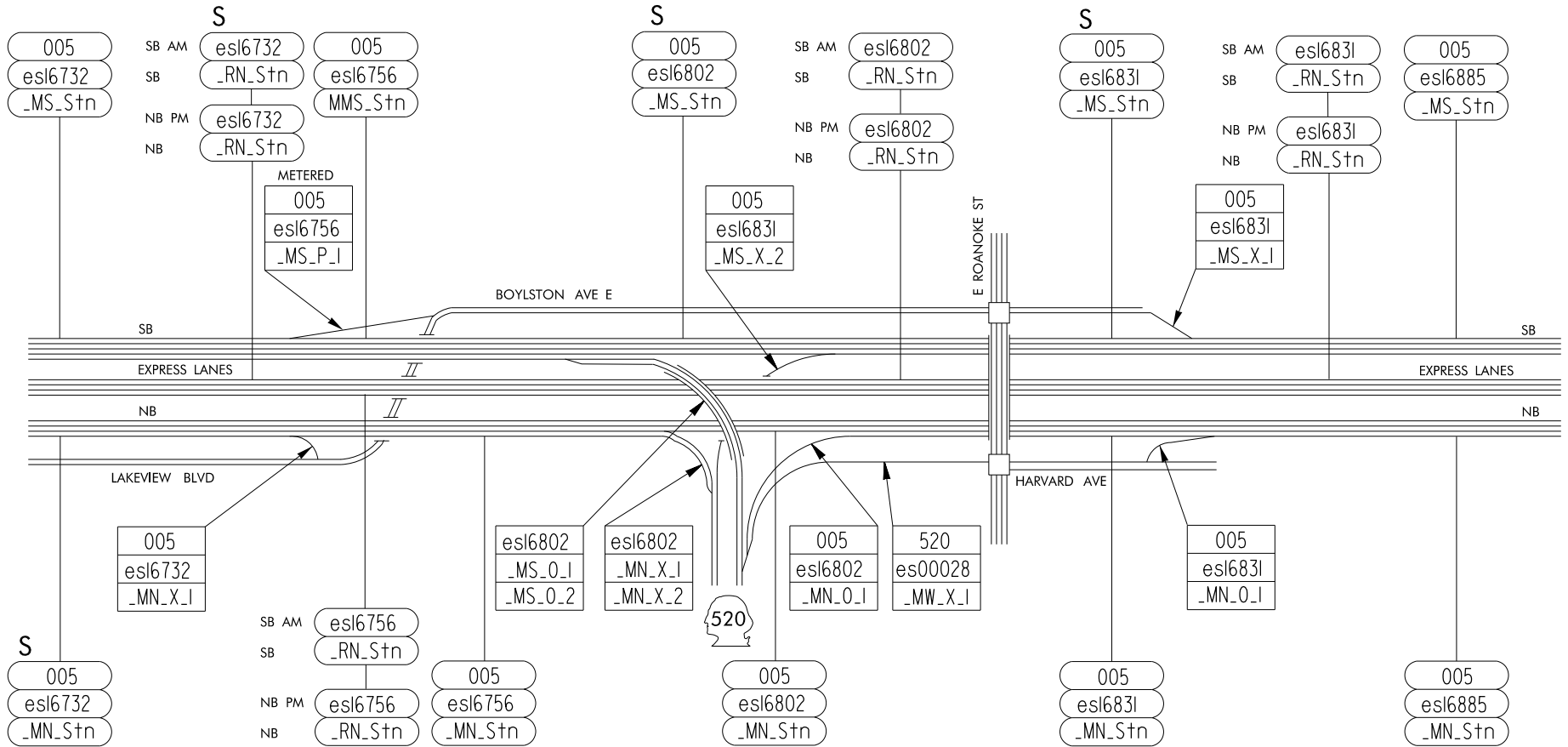

Washington State
Department of Transportation

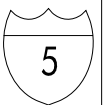

14
OF
31

NE 42ND ST

EXIT 169

NE 45TH ST

NE 50TH ST

RAVENNA BLVD

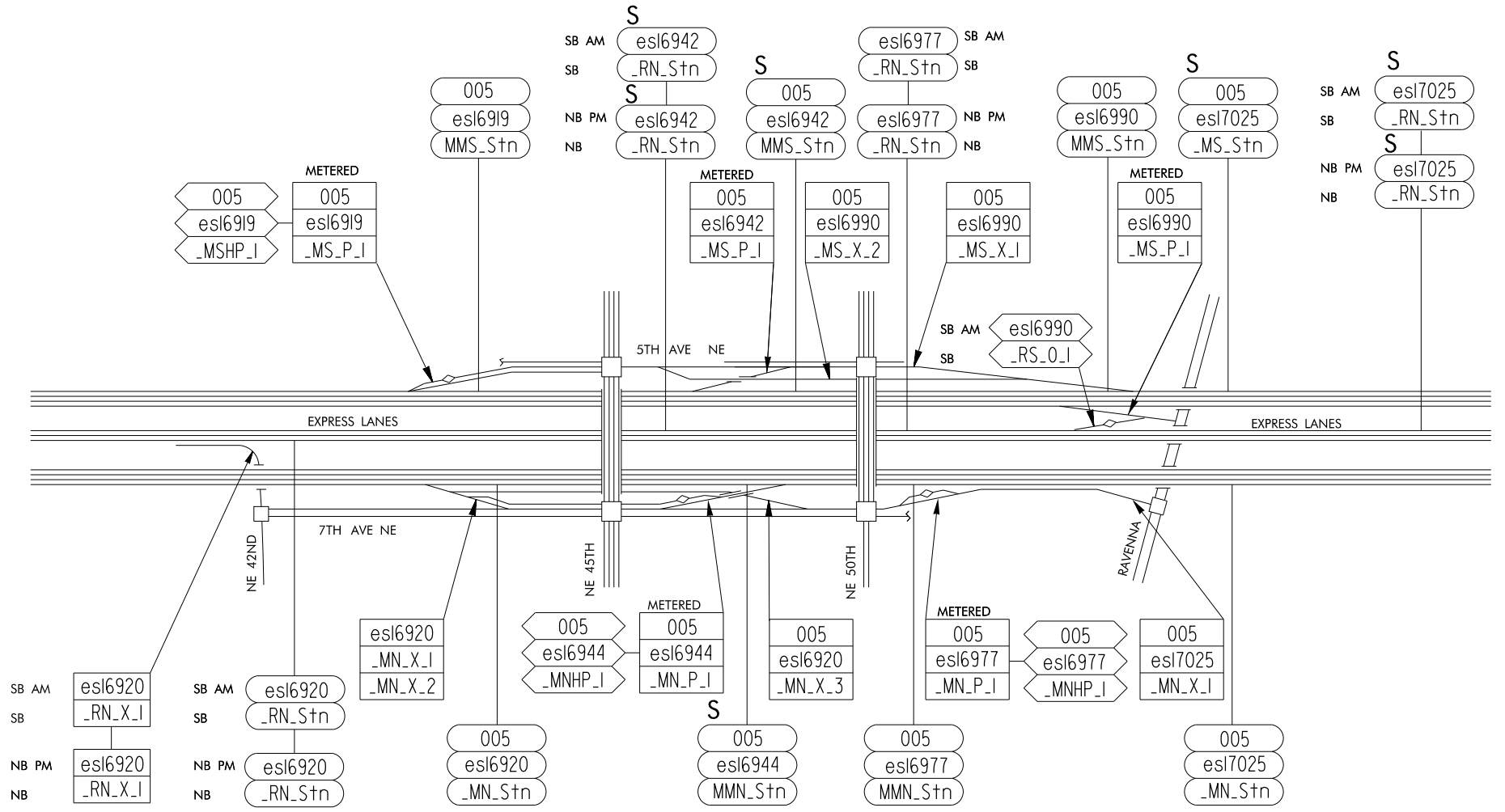

Washington State Department of Transportation



15 OF 31

EXIT 171
NE 70TH ST
LAKE CITY WY

EXIT 172
NE 80TH ST
NE 85TH ST

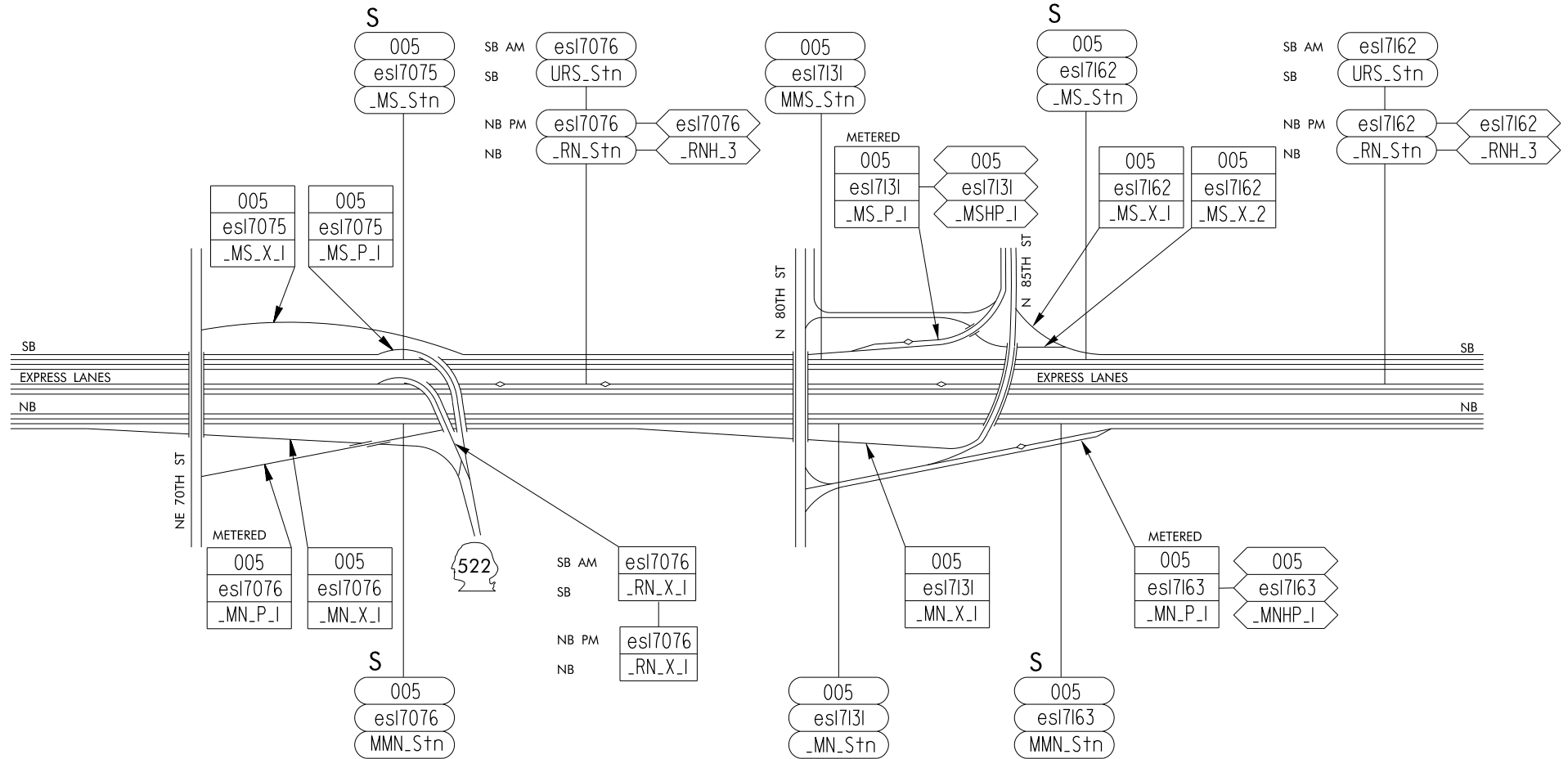

NE 92ND ST



EXIT 173

NE NORTHGATE WY

EXIT 174

NE 120TH ST

NE 130TH ST

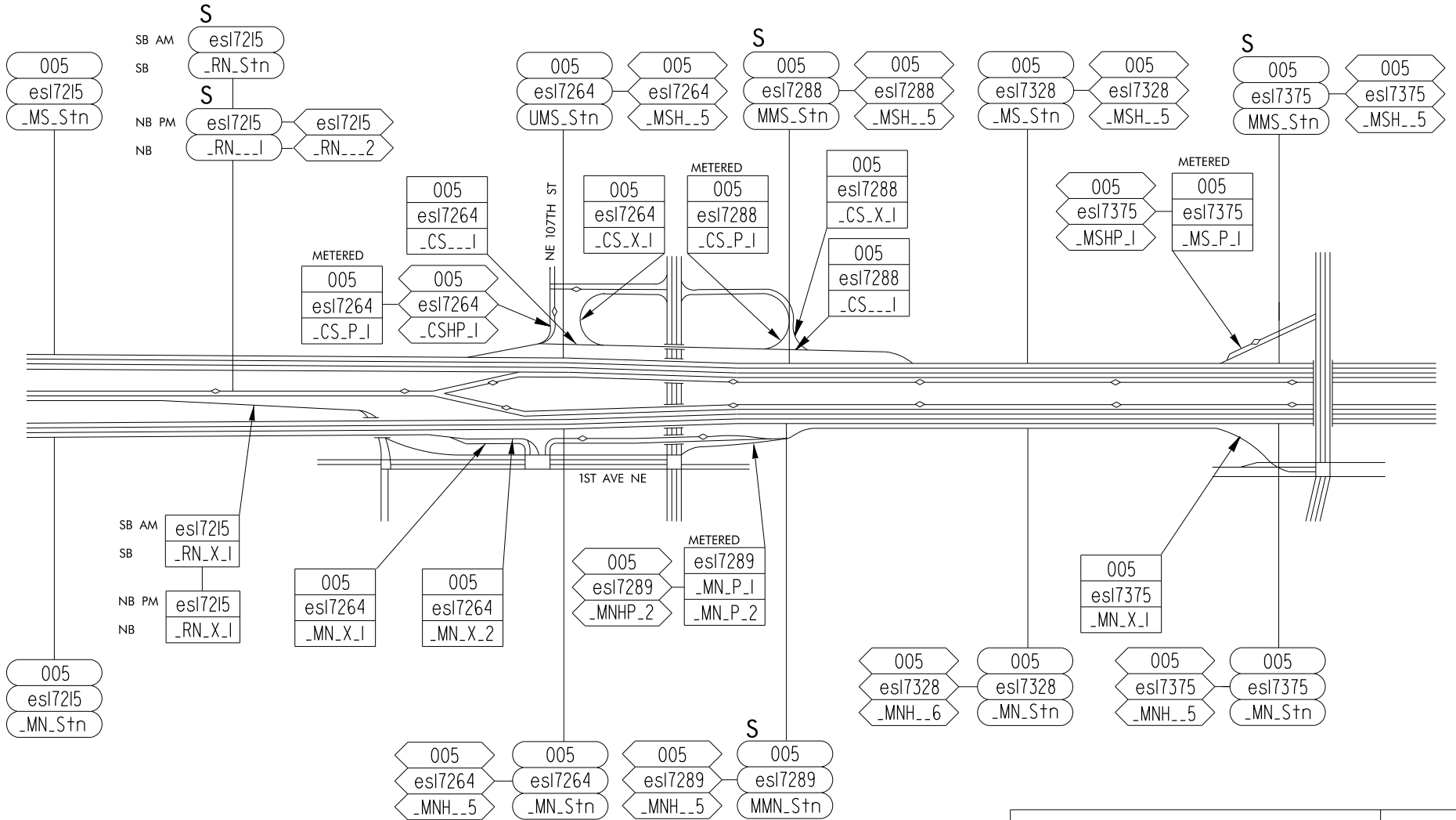

NE 137TH ST EXIT 175 SR 523 NE 145TH ST NE 155TH ST METRO NORTH BASE EXIT 176 NE 175TH ST

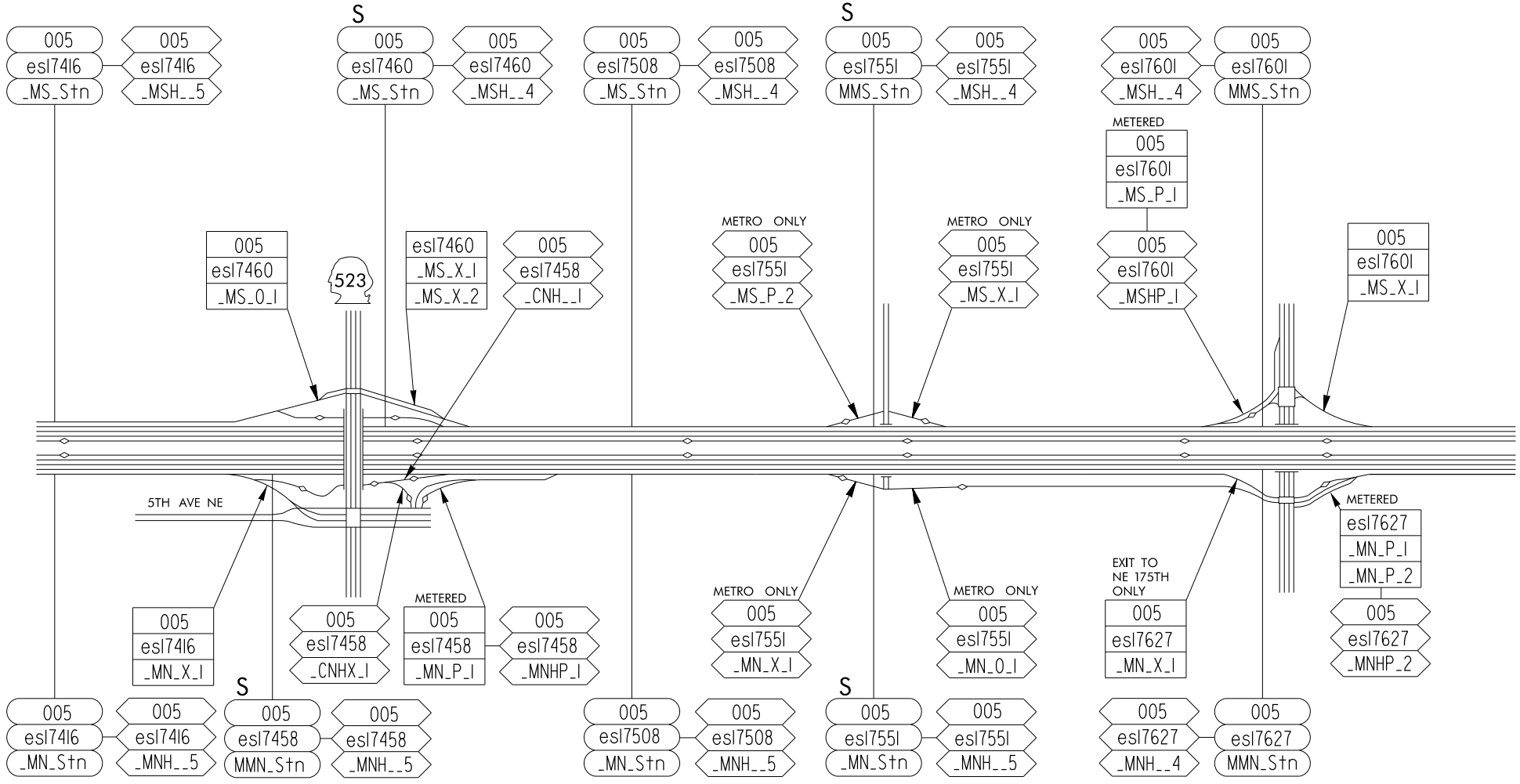

NE 195TH ST

EXIT 177
SR 104
NE 205TH ST



EXIT 178
236TH ST SW

EXIT 179
228TH ST SW 220TH ST SW

213TH ST SW

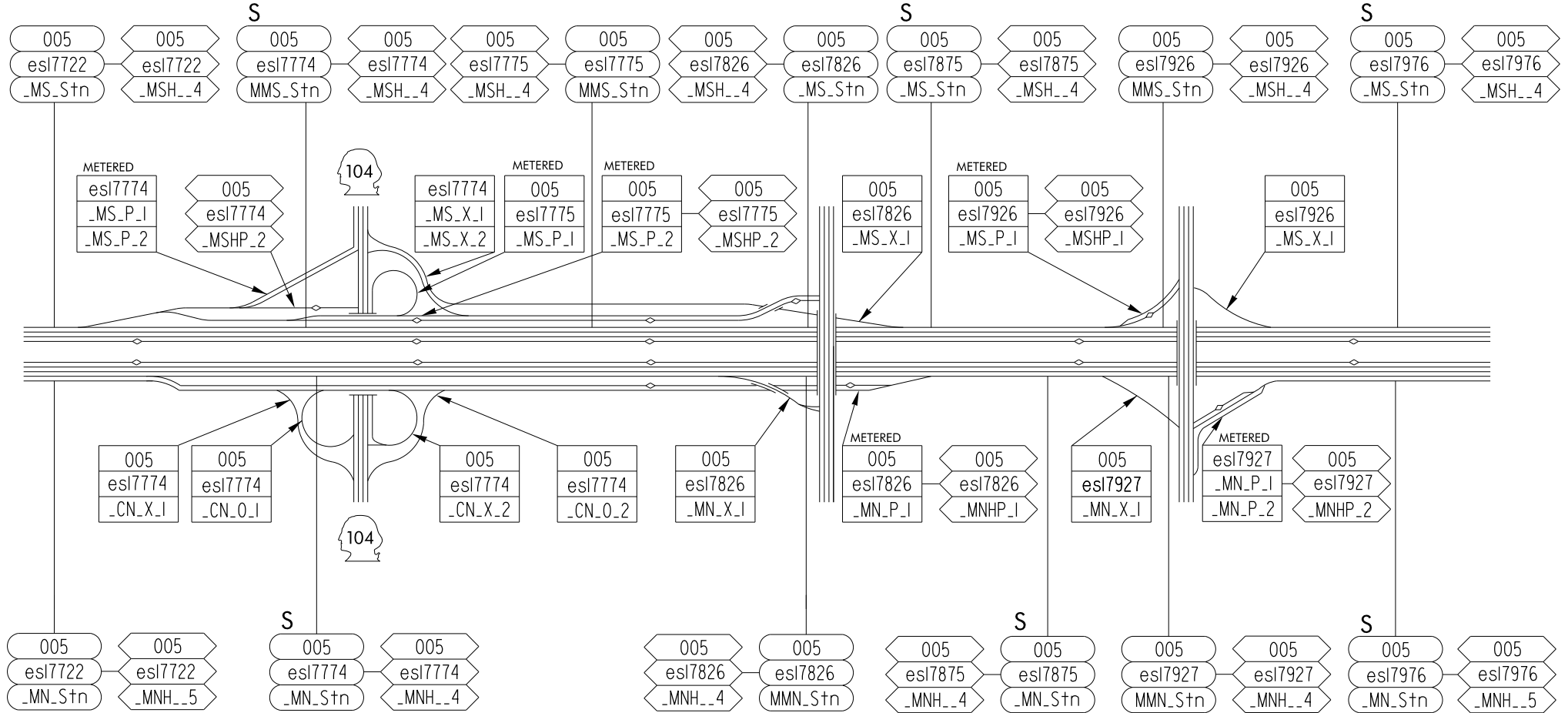

Washington State
Department of Transportation

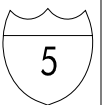

19
OF
31

208TH ST SW

LYNNWOOD
PARK & RIDE
DIRECT ACCESS

EXIT 181A

44TH AVE W

EXIT 181/181B

ALDERWOOD MALL PKWY
196TH ST SW

28TH AVE W

EXIT 182

I-405
SR 525

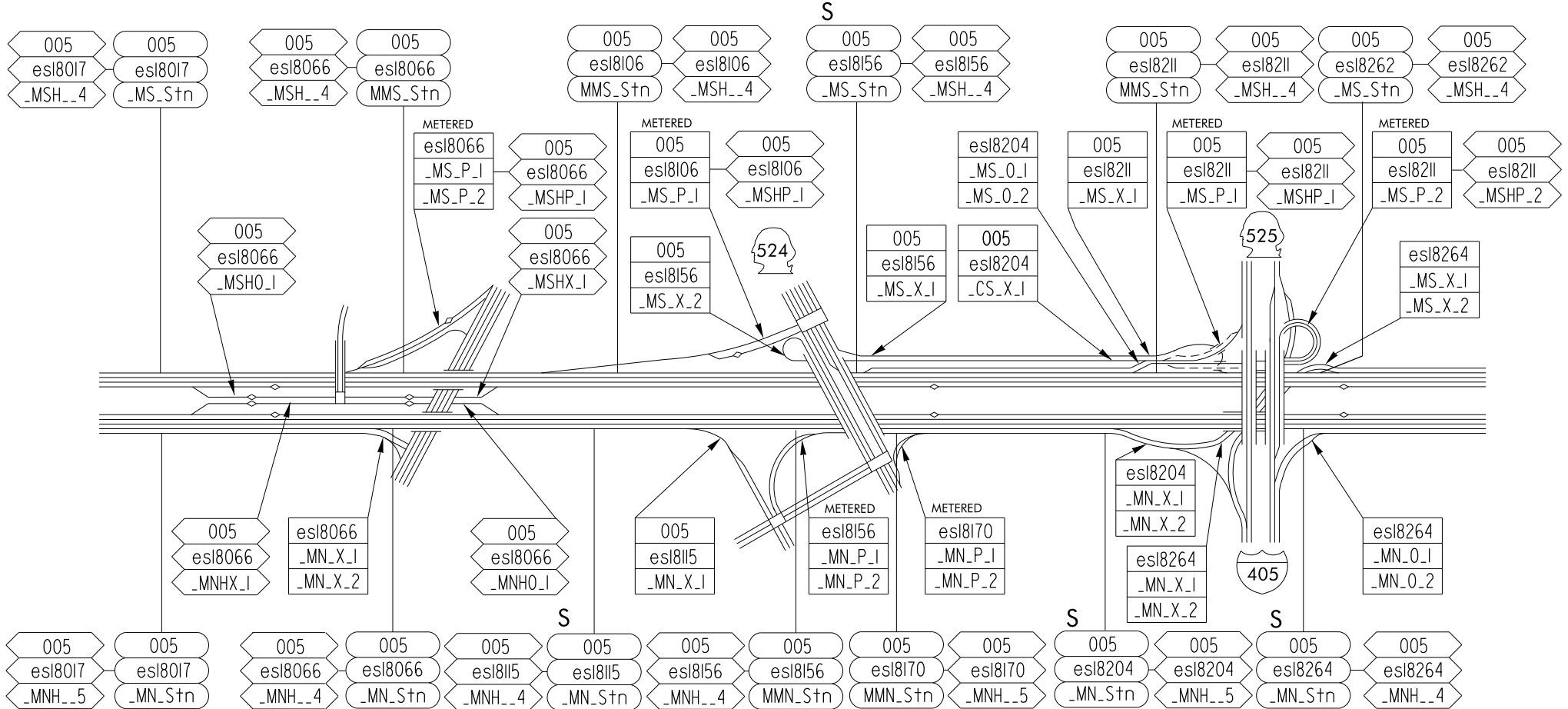

EXIT 183



175TH ST SW

164TH ST SW

ASHWAY
PARK & RIDE
DIRECT ACCESS

156TH ST SW

148TH ST SW

140TH ST SW

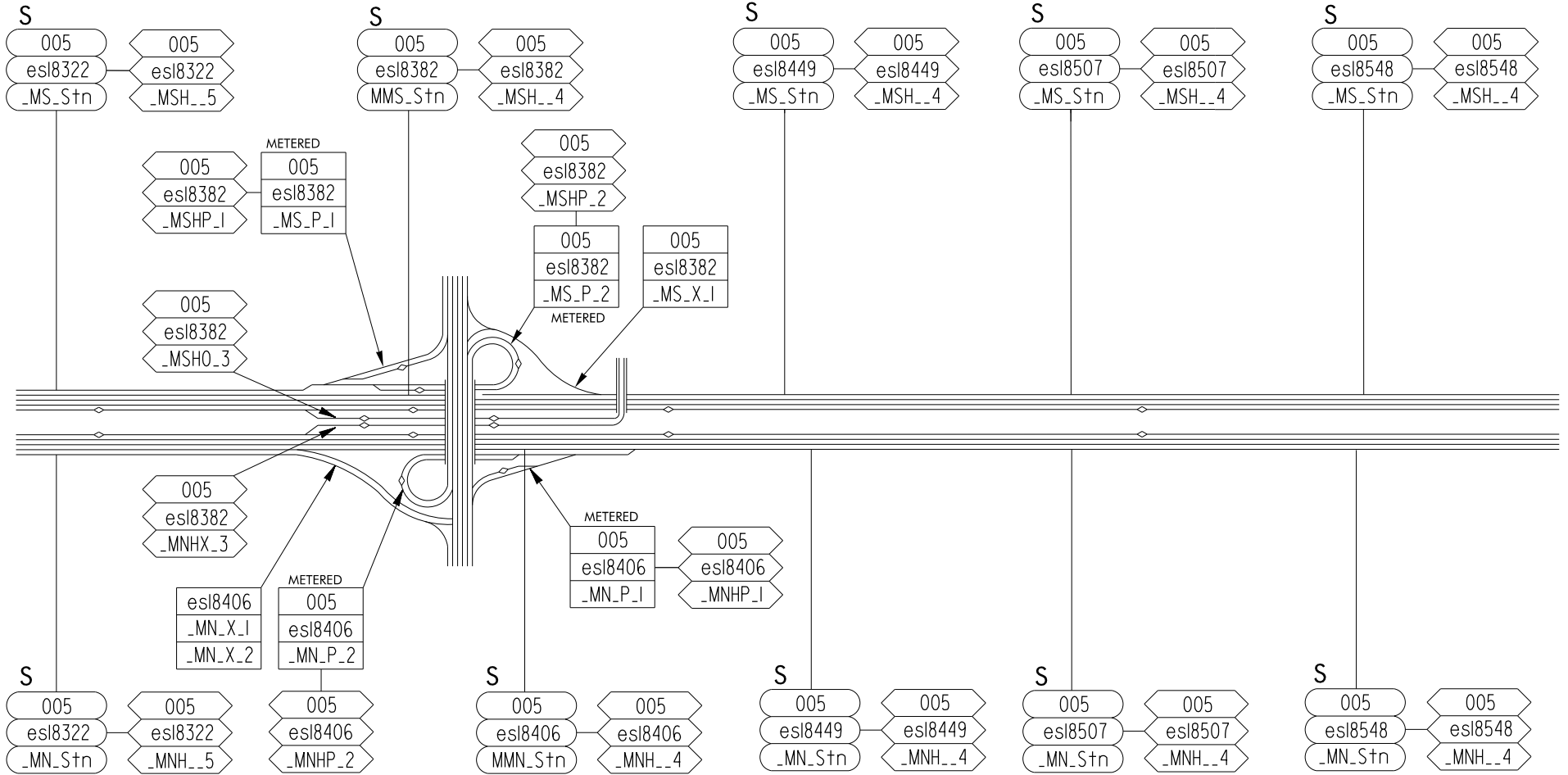

Washington State
Department of Transportation



EXIT 186

SR 96
128TH ST SW

134TH ST SW

122ND ST SE

118TH ST SE

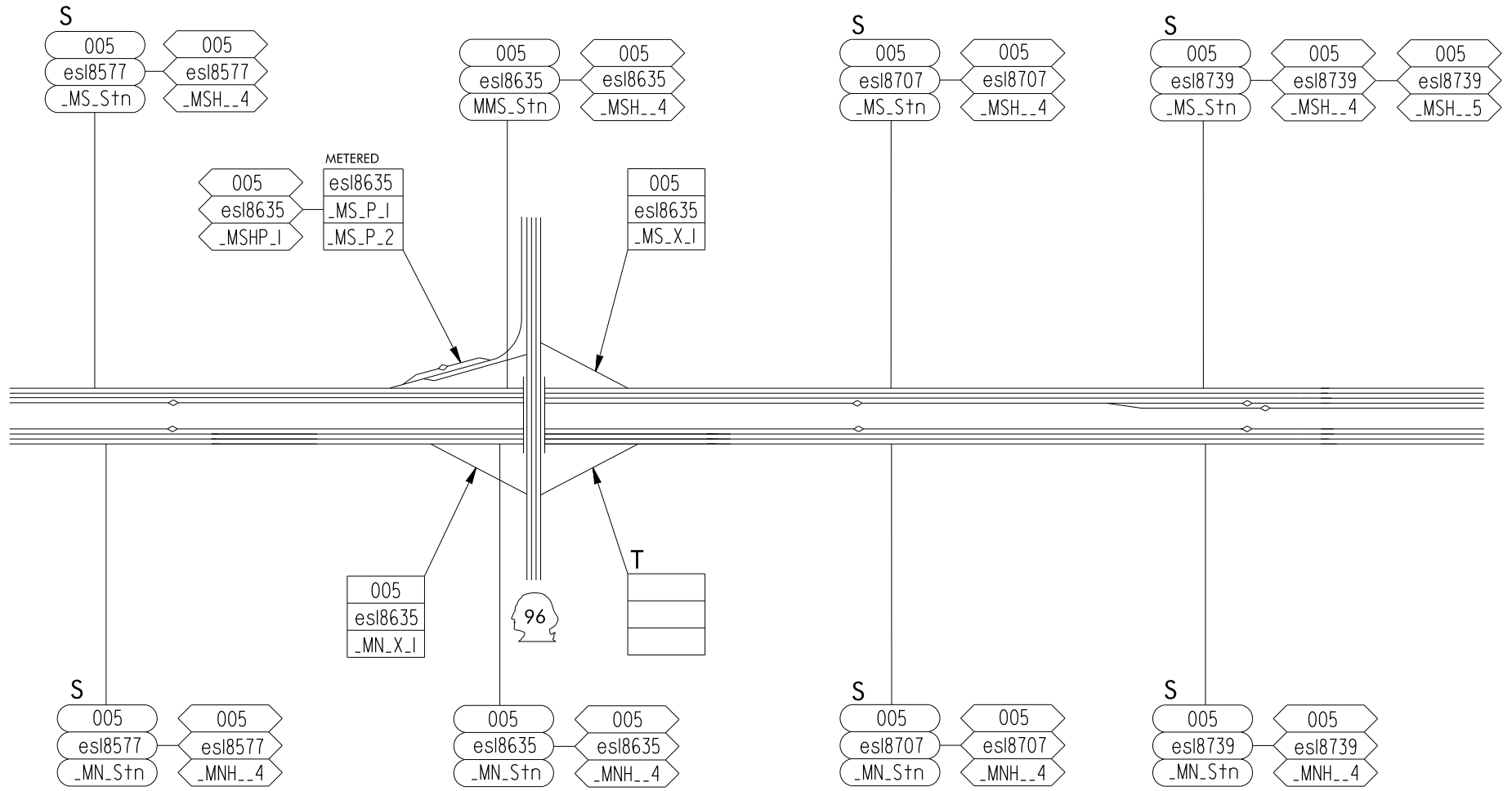

112TH ST SE
PARK & RIDE

106TH ST SE

EVERETT MALL
WAY

EXIT 189
SR 526
SR 99, SR 527

77TH ST SE

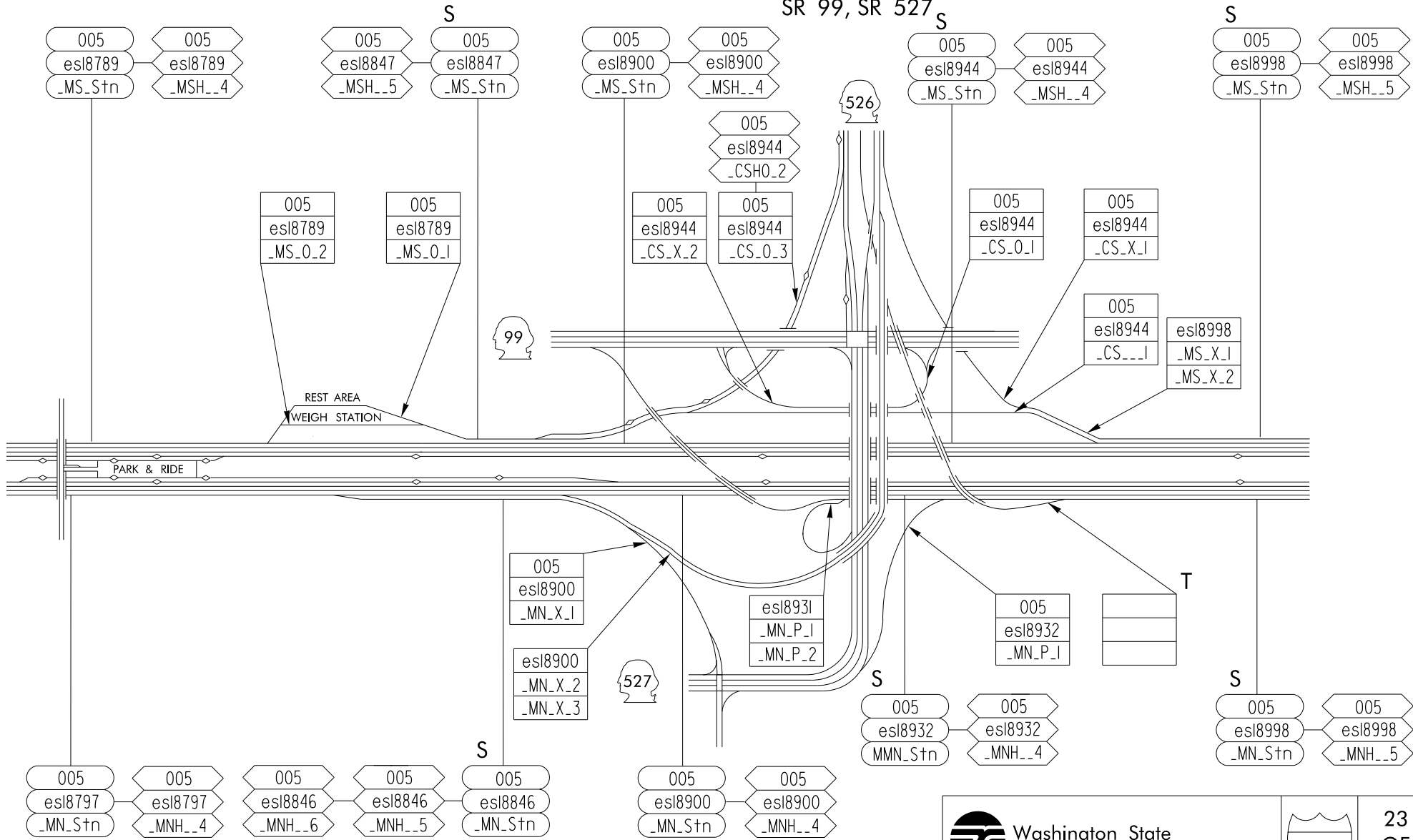

Washington State
Department of Transportation



23
OF
31

73RD ST SE

LEXINGTON AVE SE

LINCOLN ST



S

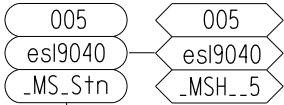

S

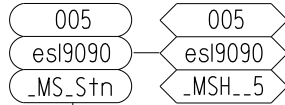

S

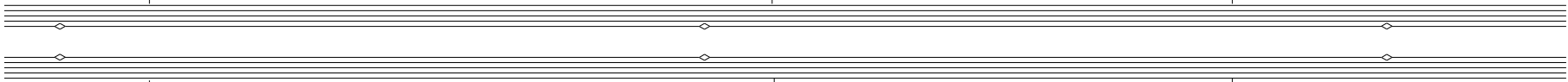
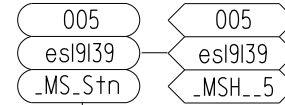

S

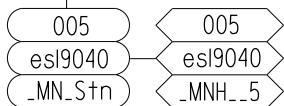

S

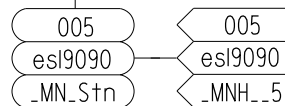

S

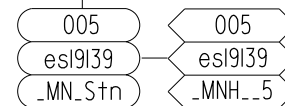

Washington State
Department of Transportation



49TH ST SE

EXIT 192
41ST ST SE

36TH ST SE

EXIT 193
PACIFIC AVE

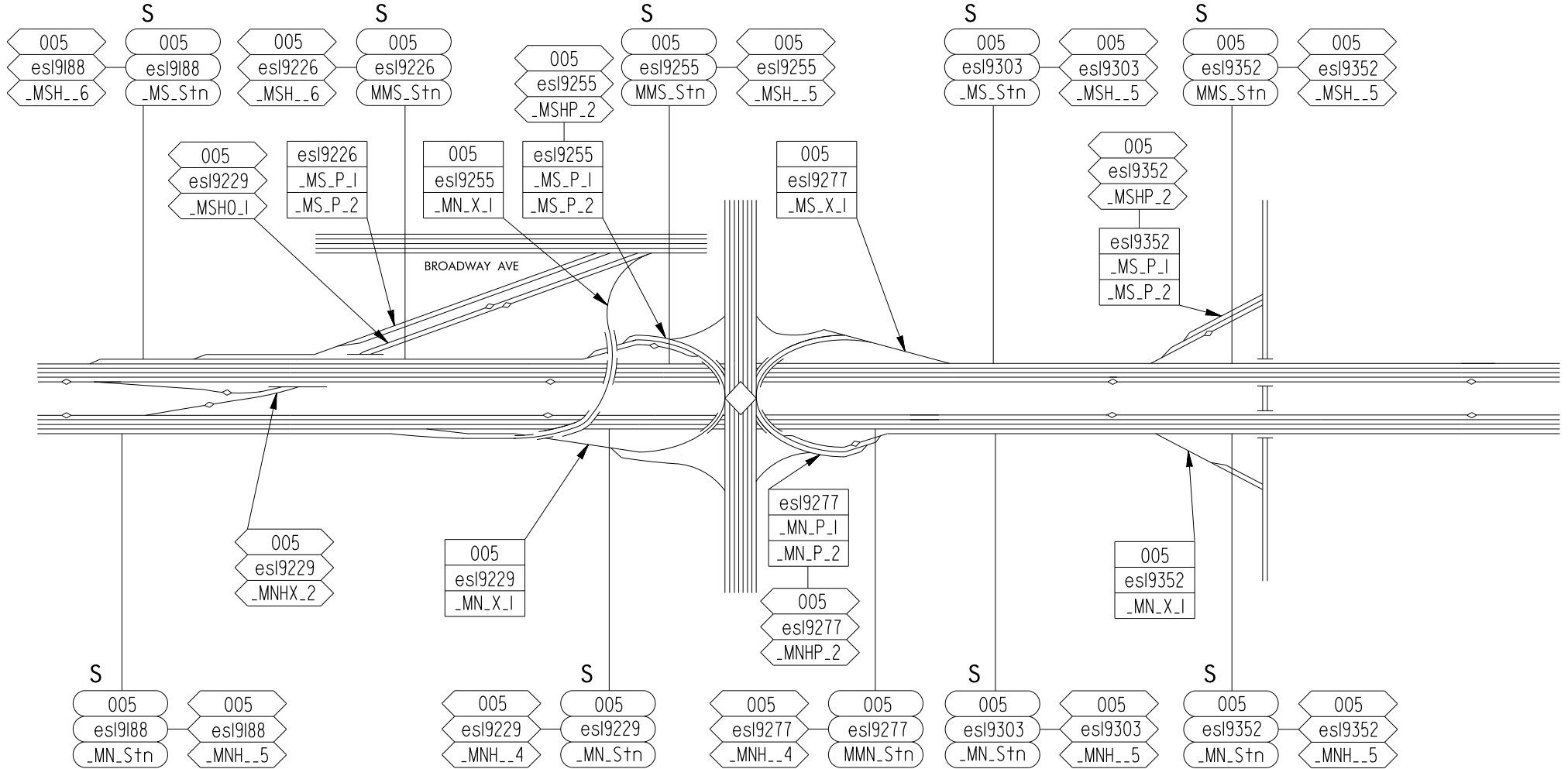

Washington State
Department of Transportation

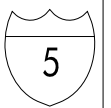



EXIT 194
US 2
EVERETT AVE

EXIT 195
GRAND AVE
MARINE VIEW DR

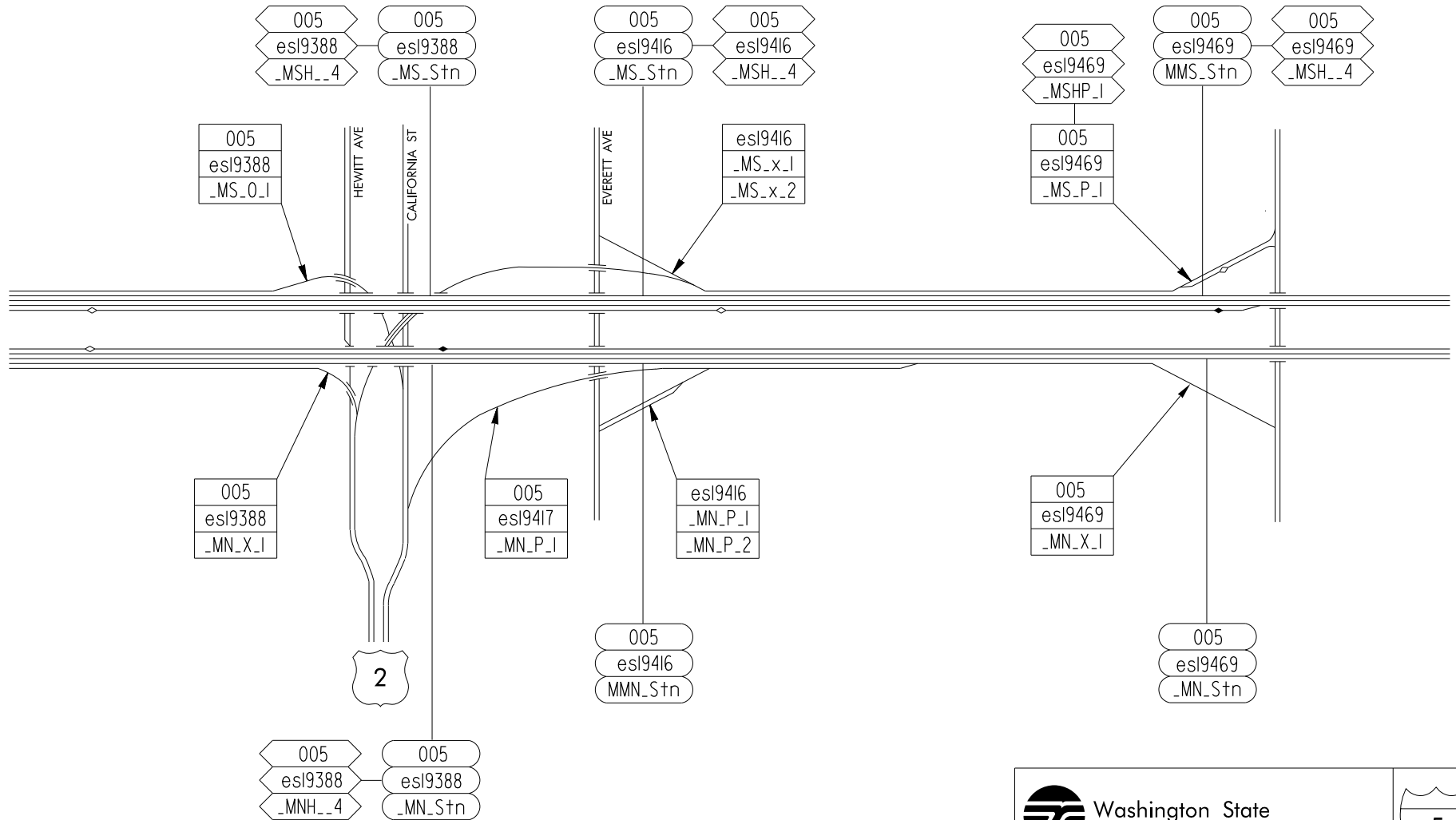

EXIT 198
SR 529

EXIT 199
SR 528
4TH ST

70TH ST NE

79TH ST NE

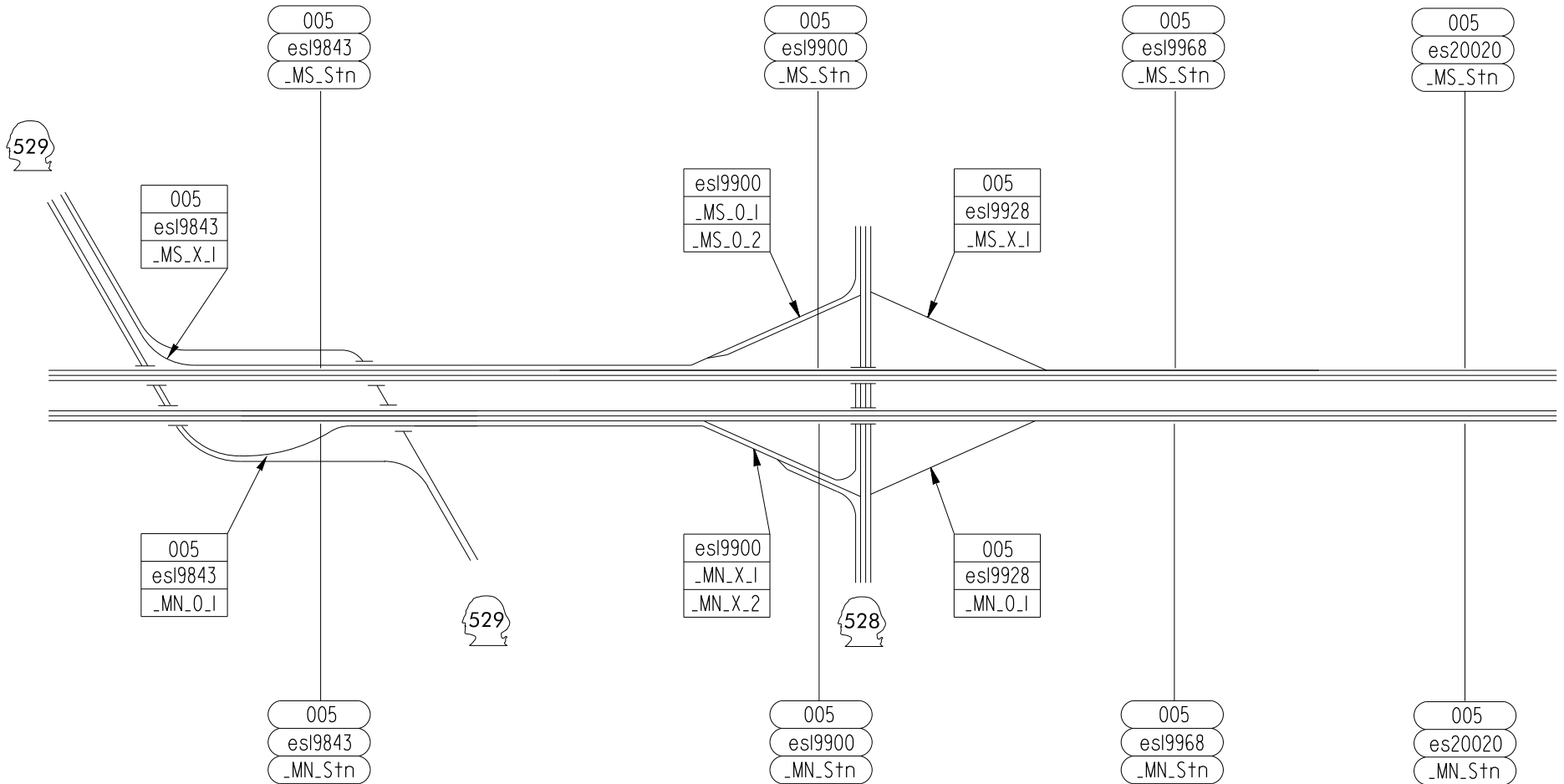

Washington State
Department of Transportation



27
OF
31

EXIT 200

88TH ST NE
QUIL CEDA WAY

98TH ST NE

105TH ST NE

EXIT 202



116TH ST NE

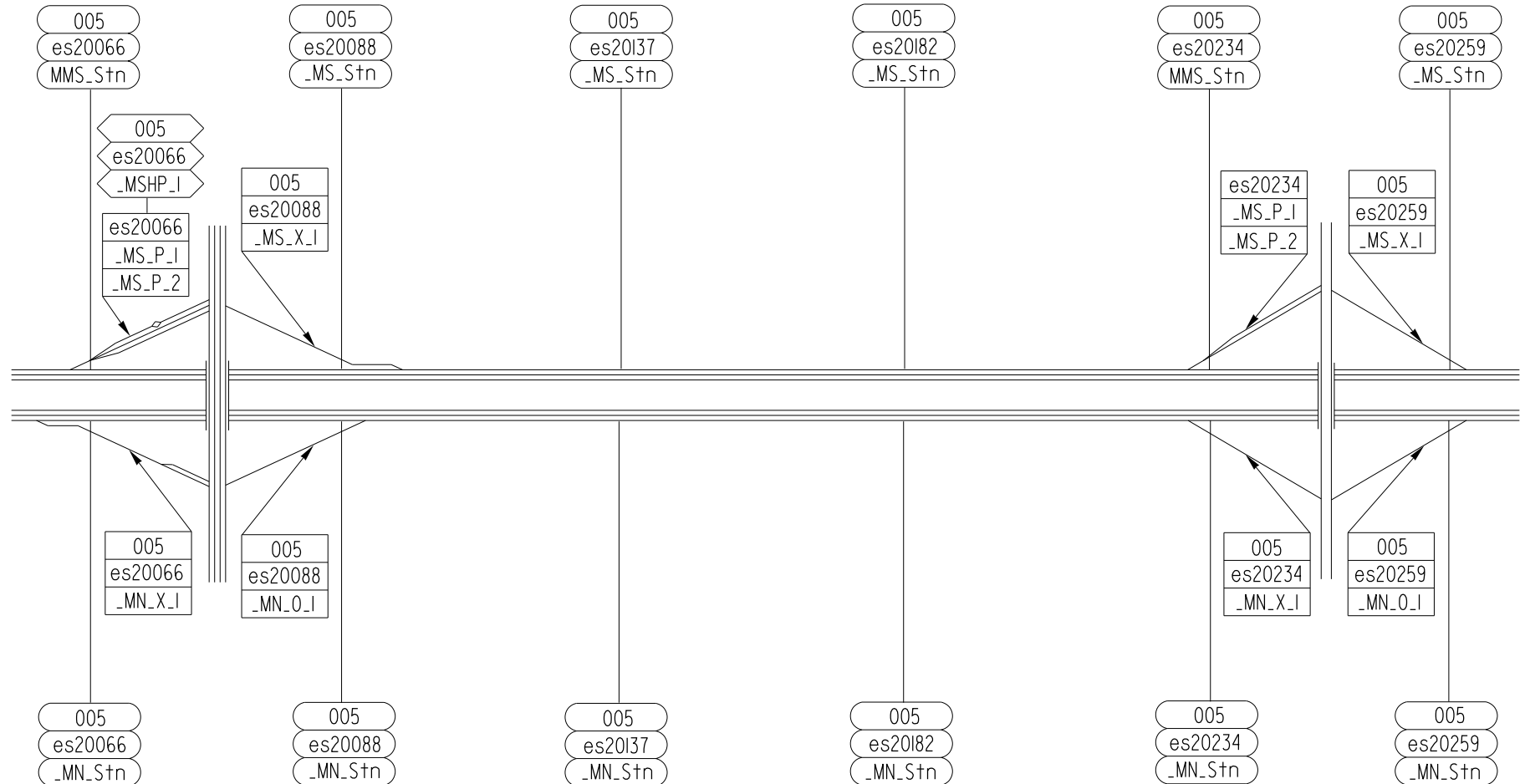

Washington State
Department of Transportation



28
OF
31



127TH ST NE

136TH ST NE

144TH ST NE

152ND ST NE

160TH ST NE

005
es20313
_MS_Stn

005
es20369
_MS_Stn

005
es20424
_MS_Stn

005
es20478
_MS_Stn

005
es20533
_MS_Stn

005
es20313
_MN_Stn

005
es20369
_MN_Stn

005
es20424
_MN_Stn

005
es20478
_MN_Stn

005
es20533
_MN_Stn



Washington State
Department of Transportation



29
OF
31

EXIT 206

SR 531
172ND ST NE
(SMOKEY PT)

180TH ST NE

189TH PL NE

200TH ST NE

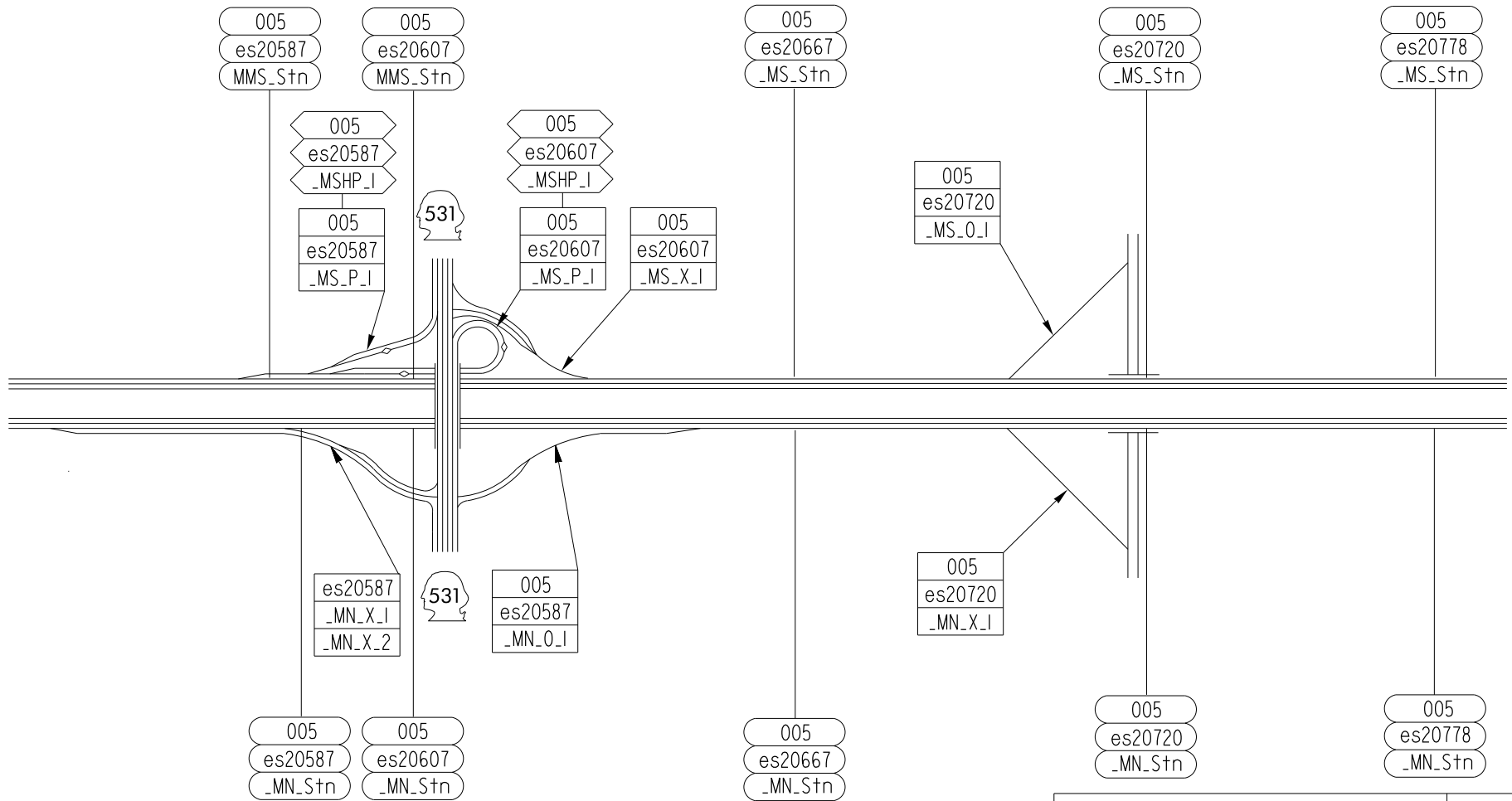



204TH ST NE

EXIT 208
SR 530
PIONEER HWY

STILLAGUAMISH
RIVER

236TH ST NE

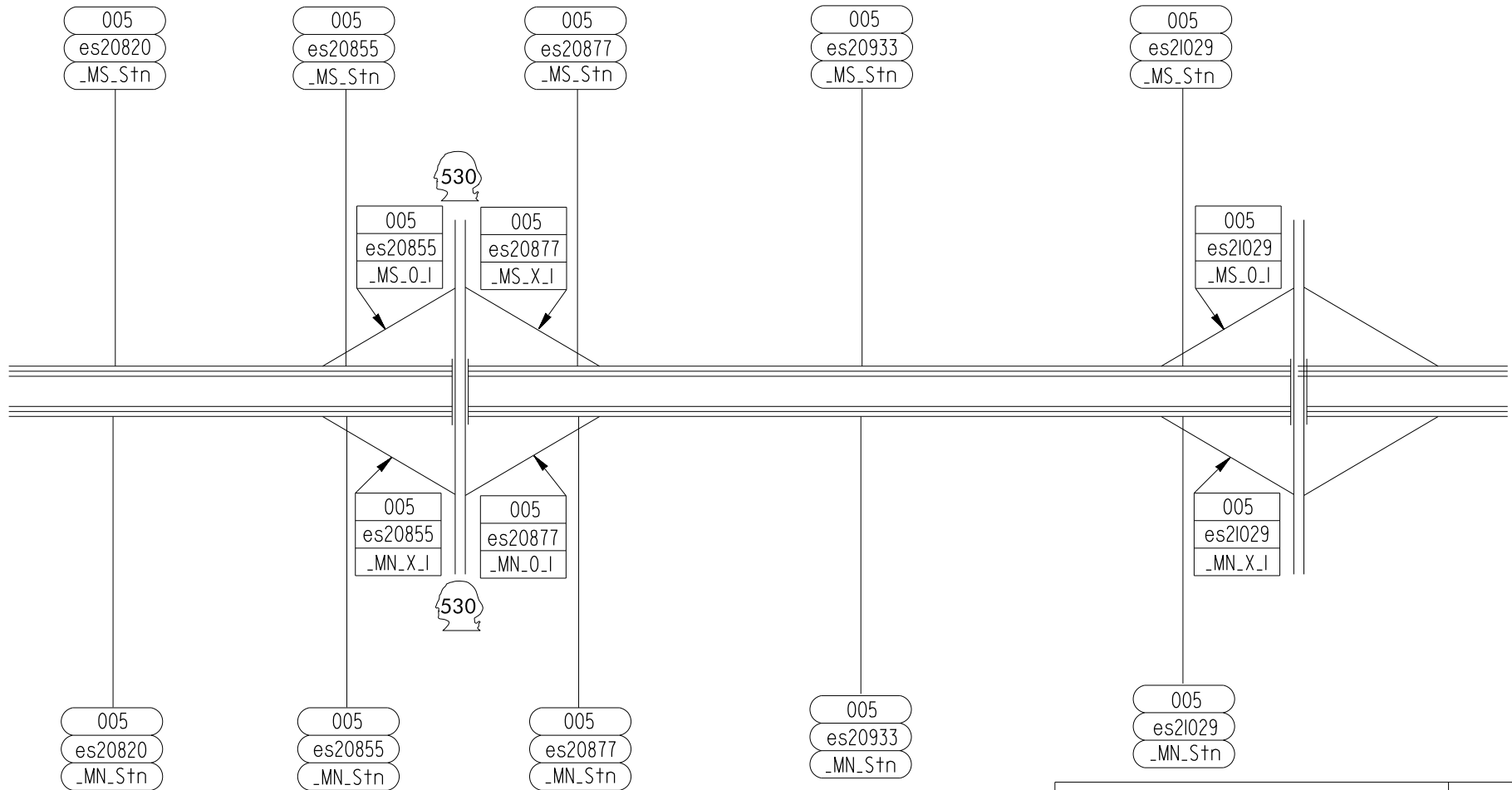

Washington State
Department of Transportation

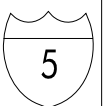

31
OF
31



I-5

WEYERHAEUSER WAY S
32ND AVE S

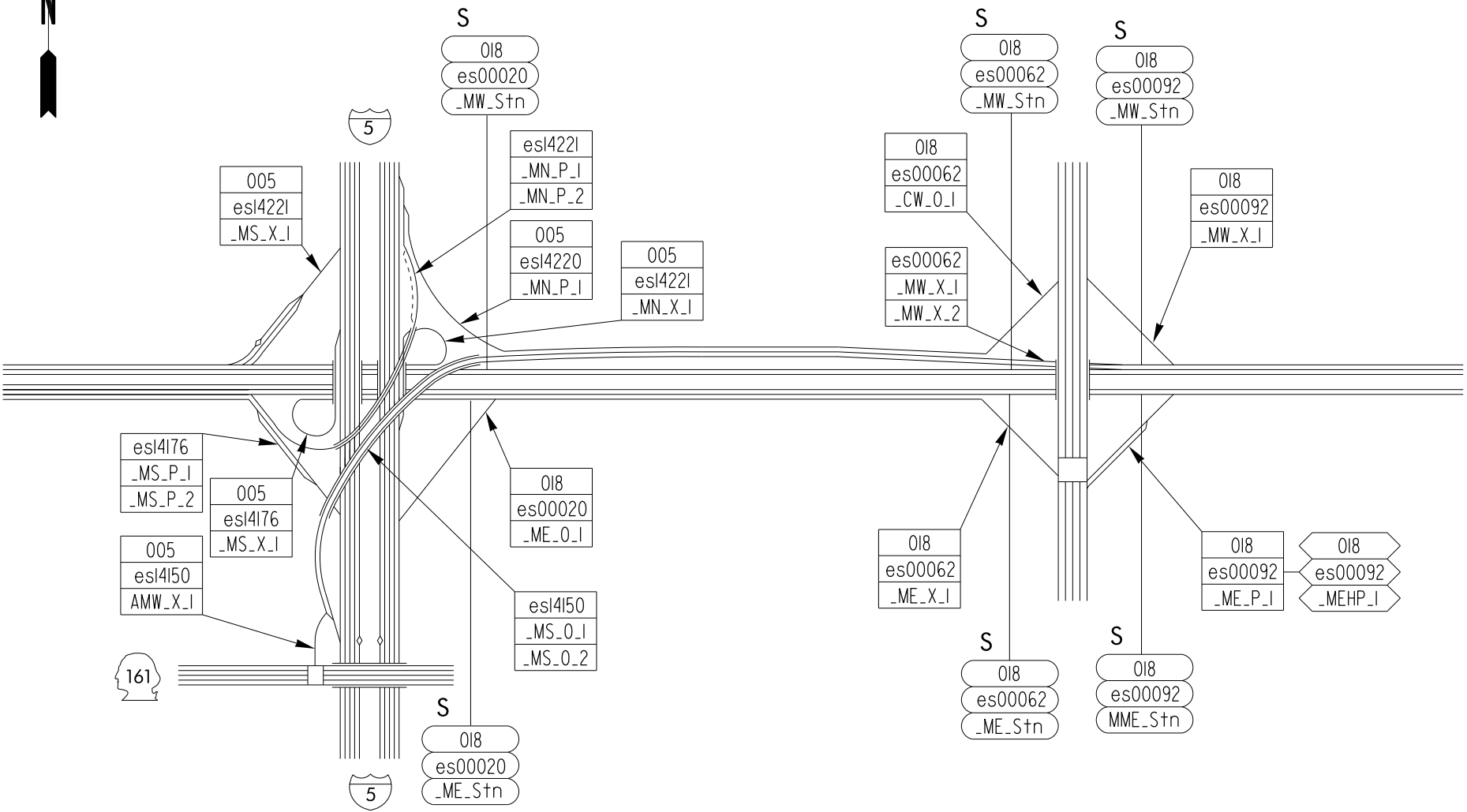

Washington State
Department of Transportation



1
OF
7



42ND AVE S

Peasley Canyon Rd

WEST VALLEY HWY SR 167

S
 018
 es00147
 _MW_Stn

S
 018
 es00185
 _MW_Stn

S
 018
 es00253
 _MW_Stn

018
 es00253
 _MW_0_1

018
 es00295
 _MW_X_2

167
 es01476
 _MS_X_1

018
 es00295
 _MW_X_1

167
 es01476
 _MN_0_1

018
 es00295
 _ME_0_1

018
 es00253
 _ME_X_1

167
 es01431
 _AME_X_1

167
 es01431
 _ACE_0_1

167
 es01431
 _MS_X_1

es01431
 _MN_0_1
 _MN_0_2

167
 es01431
 _MN_X_1

S
 018
 es00147
 _ME_Stn

S
 018
 es00185
 _ME_Stn

S
 018
 es00253
 _ME_Stn



Washington State
Department of Transportation



2
OF
7



"C" ST

"A" ST

AUBURN WY
SR 164

"V" ST

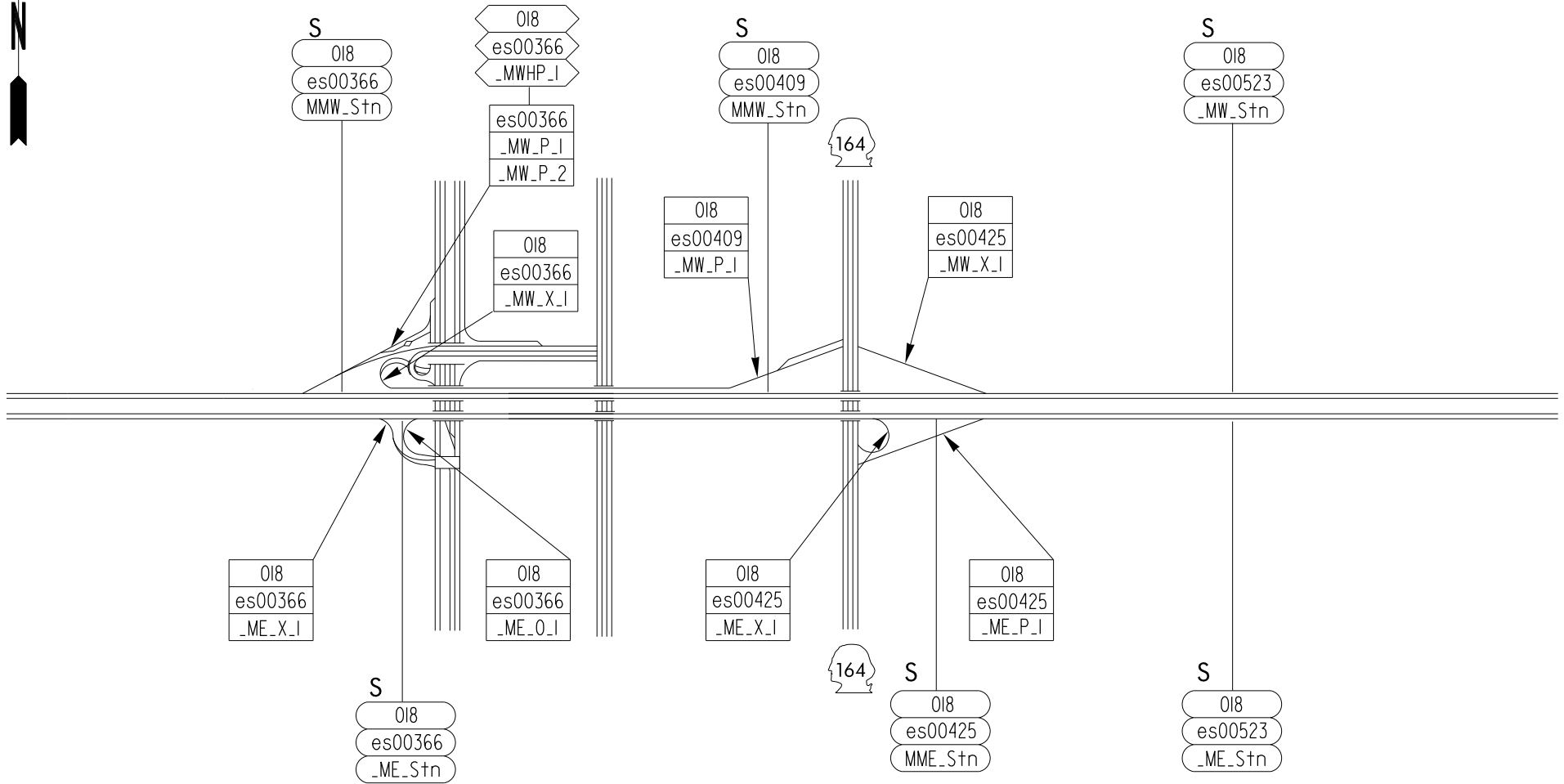

Washington State
Department of Transportation



3
OF
7

AUBURN-
BLACK DIAMOND RD

SE 304TH ST

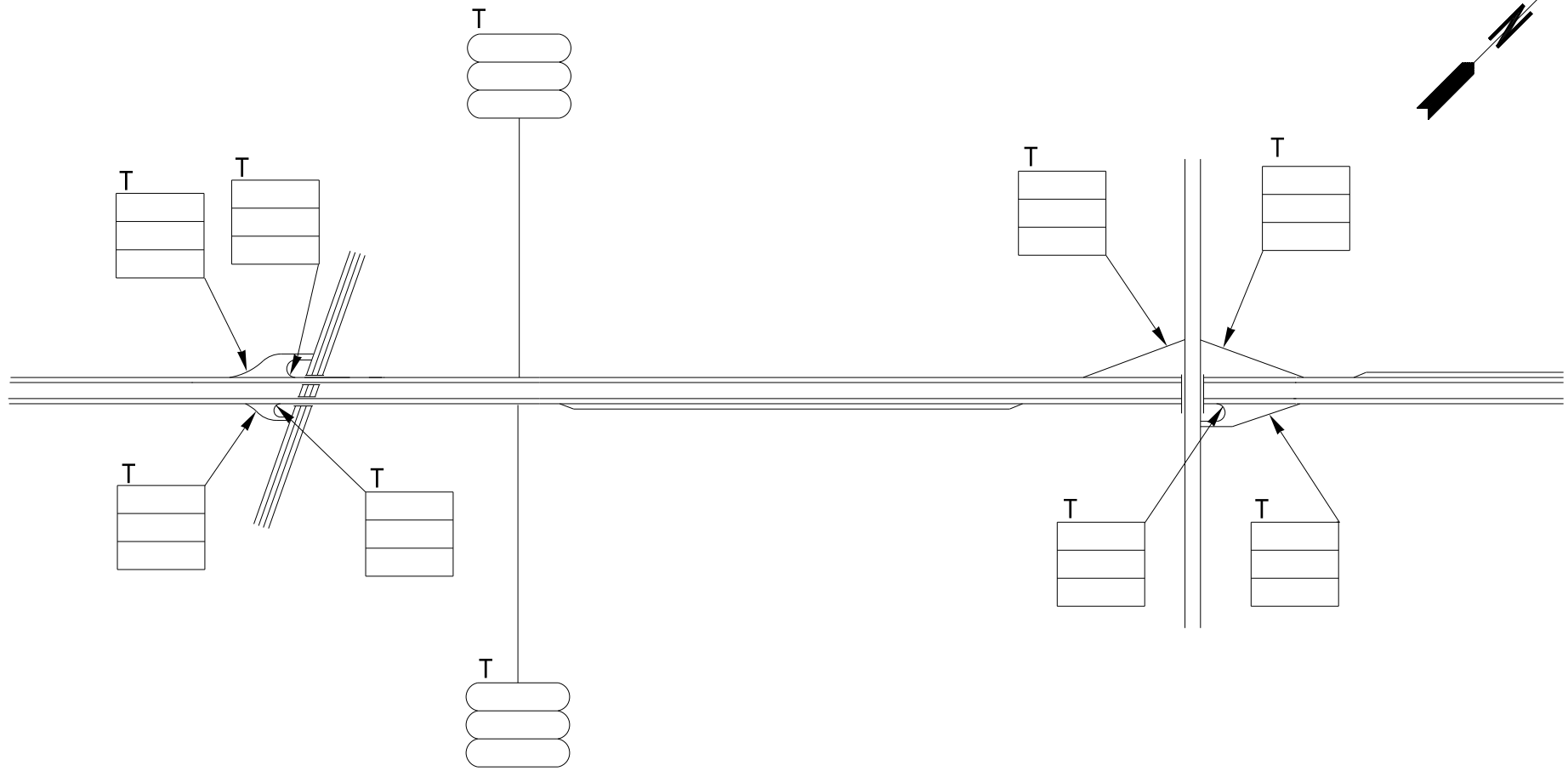
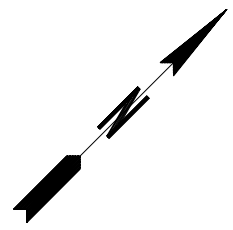

Washington State
Department of Transportation

18

4
OF
7

SE 272ND ST
SR 516

180 AVE SE

SE 256TH ST

SE 252ND ST

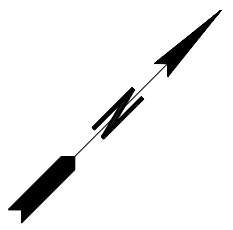

S
018
es01257
_MW_Stn

S
018
es01363
_MW_Stn

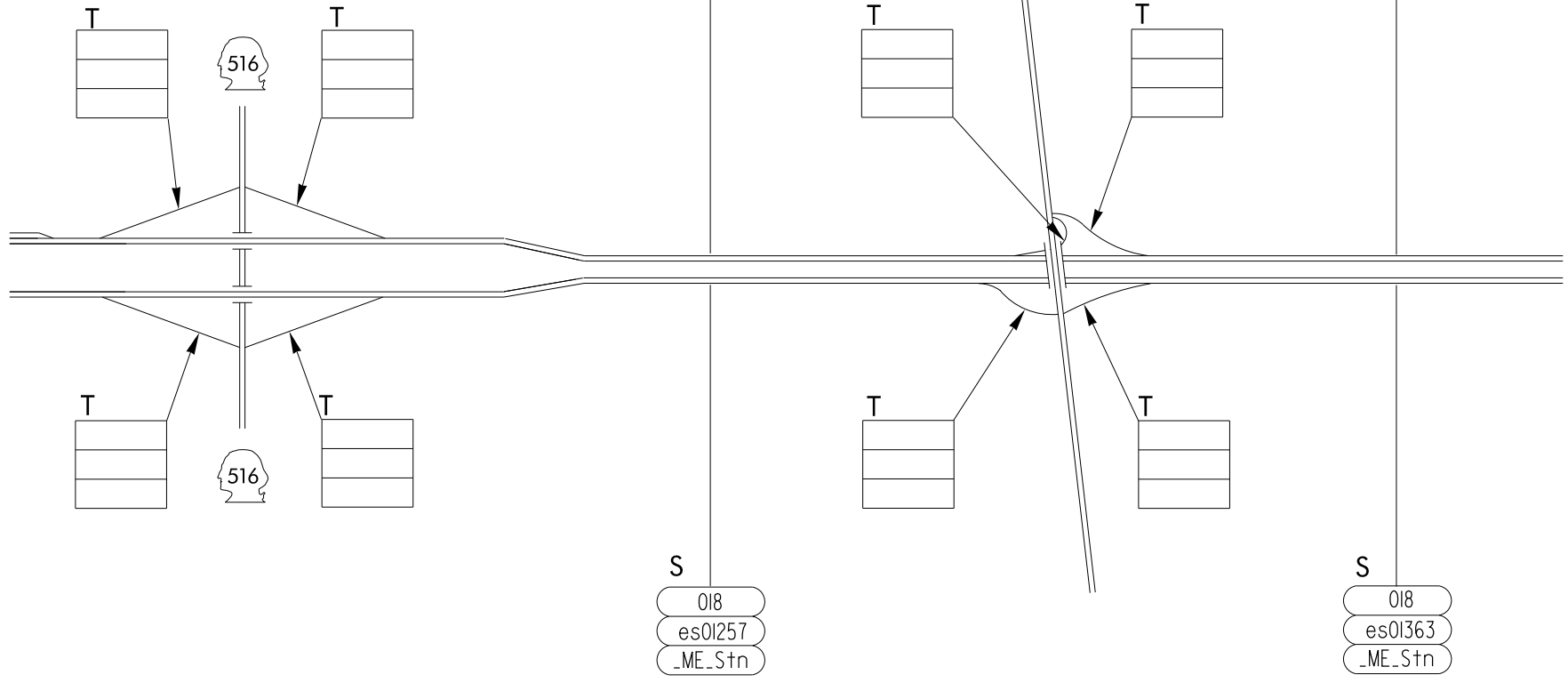

SE 240TH ST

SE 231TH ST
MAPLE VALLEY

SE 221ST ST

RENTON
MAPLE VALLEY RD
SR 169

236TH AVE SE

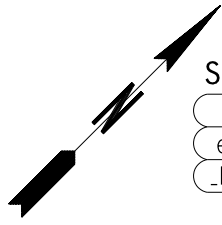

S
018
es01500
_MW_Stn

S
018
es01581
_MW_Stn

S
018
es01634
_MW_Stn

S
018
es01678
_MW_Stn

S
018
es01744
_MW_Stn

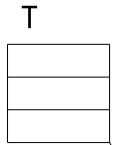

018
es01581
_MW_X_I

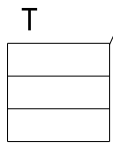

018
es01581
_ME_O_I

S
018
es01500
_ME_Stn

S
018
es01581
_ME_Stn

S
018
es01634
_ME_Stn

S
018
es01678
_ME_Stn

S
018
es01744
_ME_Stn



Washington State
Department of Transportation



18

6
OF
7

244TH AVE SE

SE 200TH ST

ISSAQUAH-HOBART RD

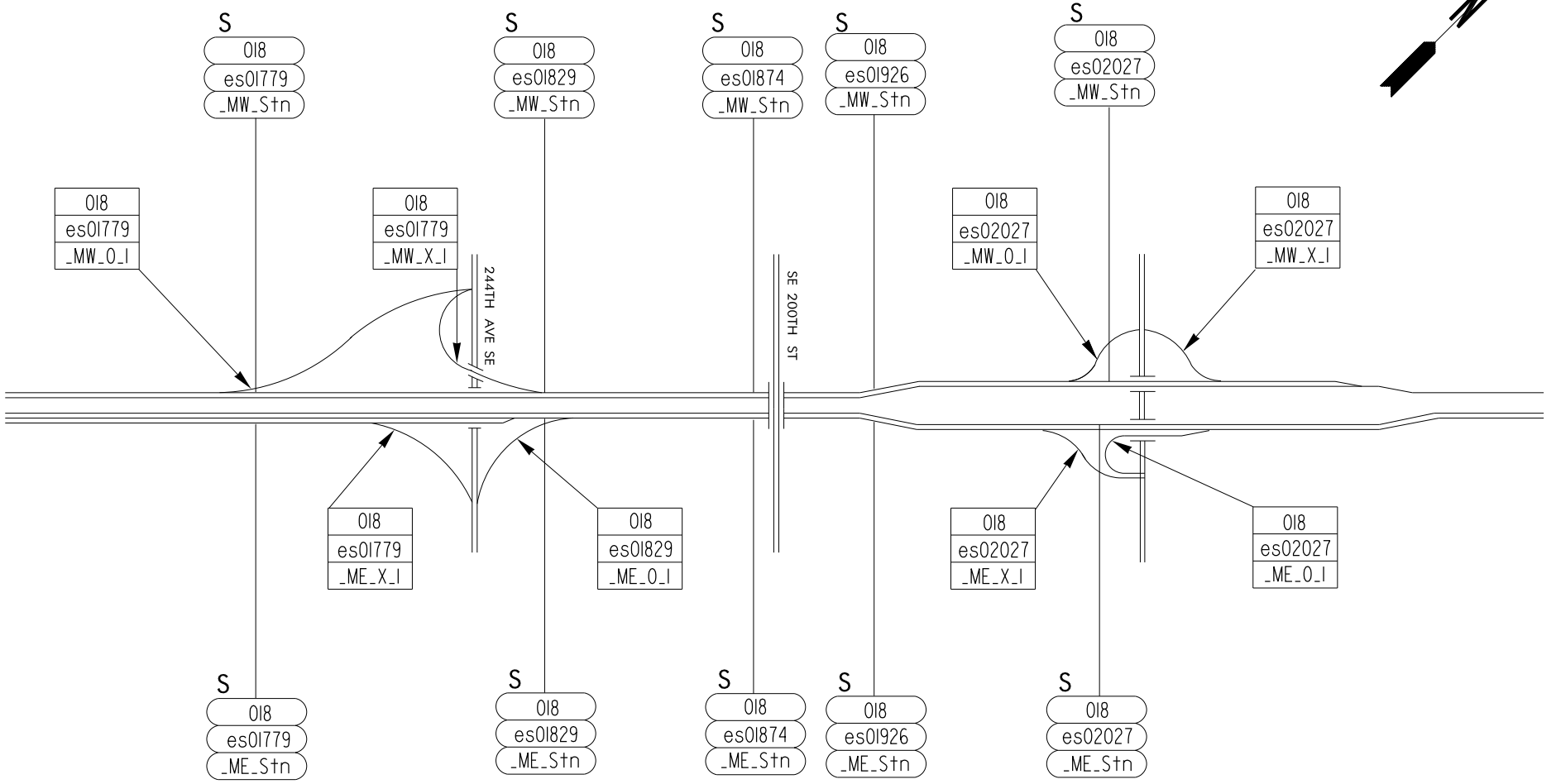
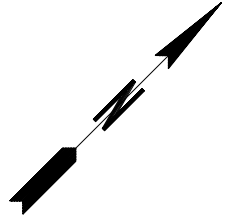

Washington State
Department of Transportation

18

7
OF
7



EXIT 2B\2C
I-5

S NORMAN ST

S

090
es00302
_MW_Stn

T

4TH AVE S

005
esl6429
_CS_X_I

SB CD

NB CD

es00278
_MW_X_1
_MW_X_2

090
es00278
_MW_X_3

METERED

005
esl6466
_CN_P_I

S DEARBORN ST

es00207
_MW_X_1
_MW_X_2

S ATLANTIC ST

AIRPORT WAY S

METERED

005
esl6442
_MS_P_I

es00261
_ME_P_1
_ME_P_2

es00262
_ME_P_1
_ME_P_2

090
es00261
_MW_0_I

090
es00259
_ME_P_1

090
es00207
UME_Stn

S

090
es00302
_ME_Stn



Washington State
Department of Transportation

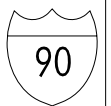

1
OF
11

EXIT 3A\3B
RAINIER AVE S

23RD AVE S

35TH AVE S

WEST HIGHRISE

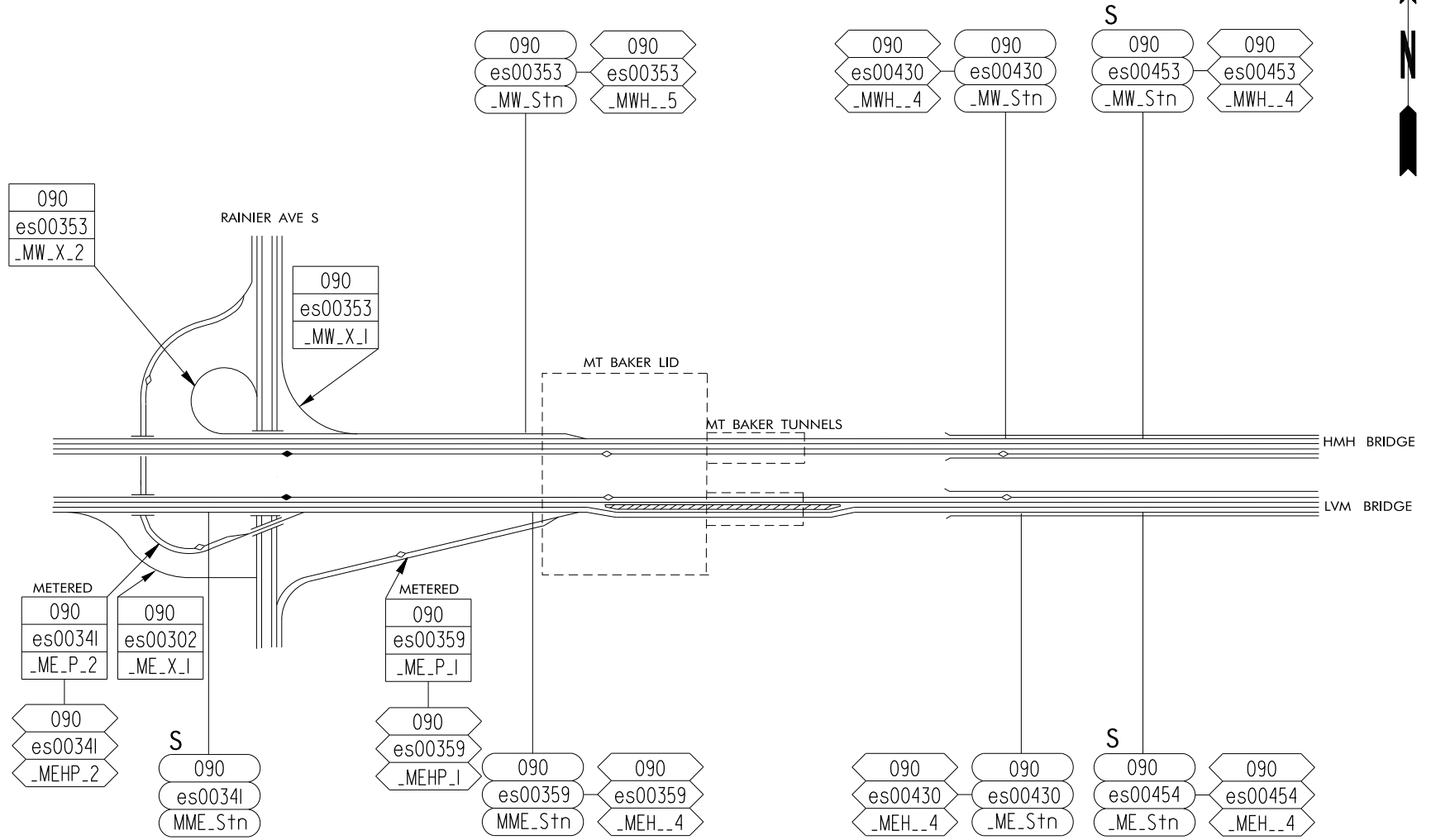

Washington State
Department of Transportation

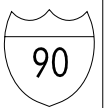

2
OF
11



MIDSPAN EAST HIGHRISE EXIT 6A
W MERCER WY 76TH AVE SE 77TH AVE SE

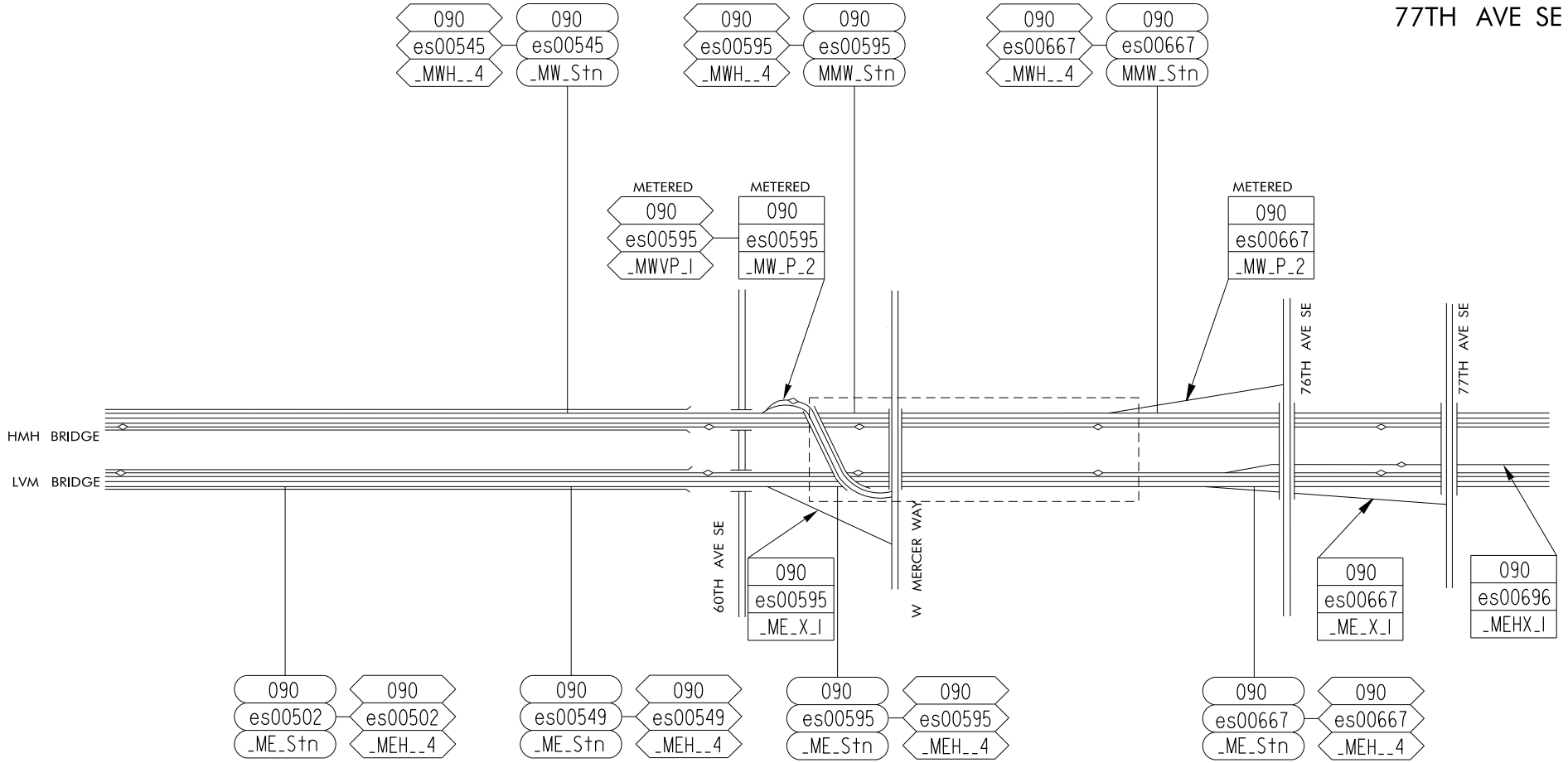



EXIT 7\7B
ISL CREST WY

SHOREWOOD
DRIVE

EXIT 8
E MERCER WY

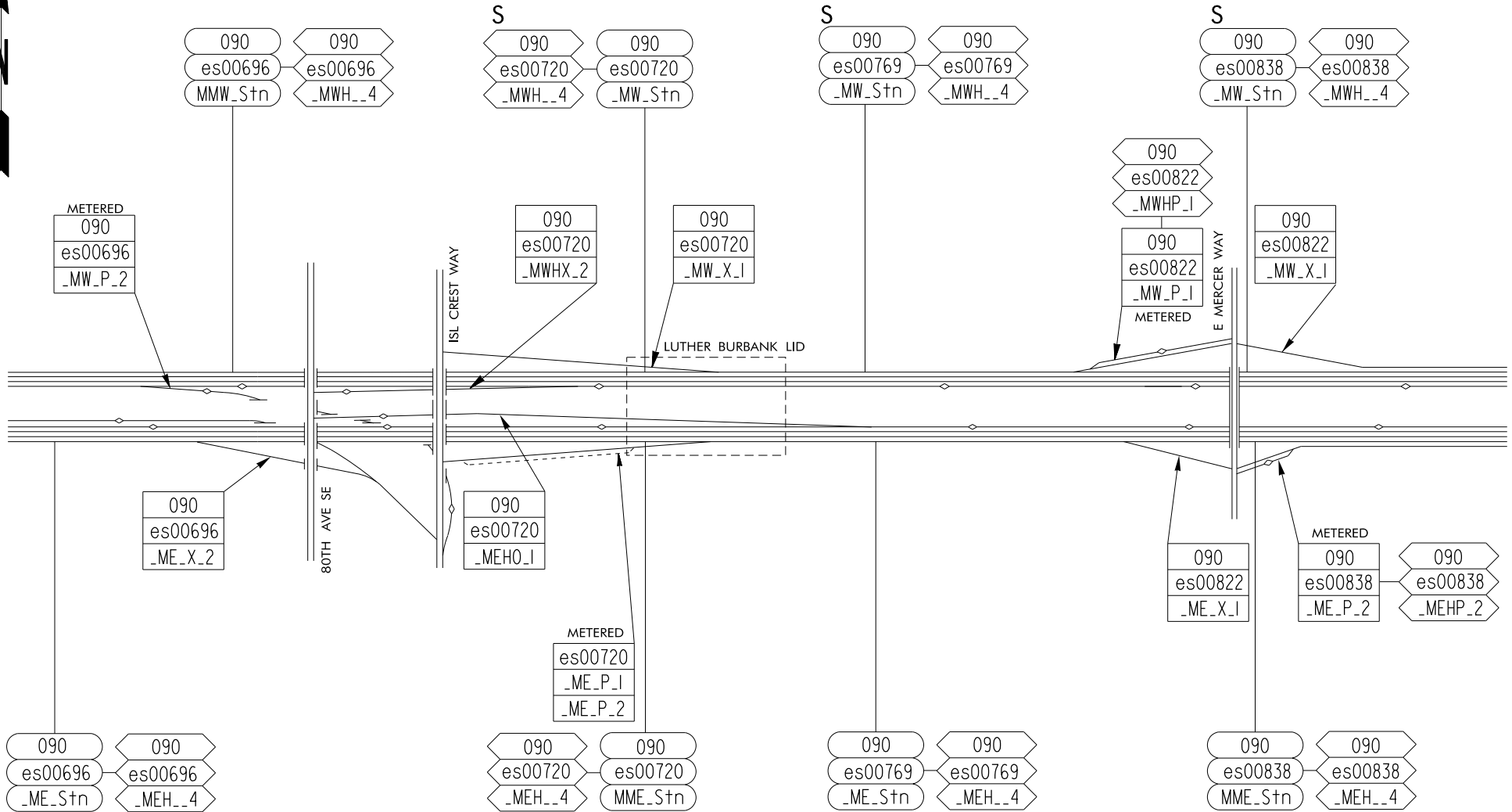

Washington State
Department of Transportation

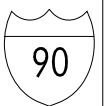

EXIT 9

EXIT 10\10B

EXIT 10B

E CHANNEL BRIDGE

BELLEVUE WY 118TH AVE SE

I-405

RICHARDS RD 132ND AVE SE

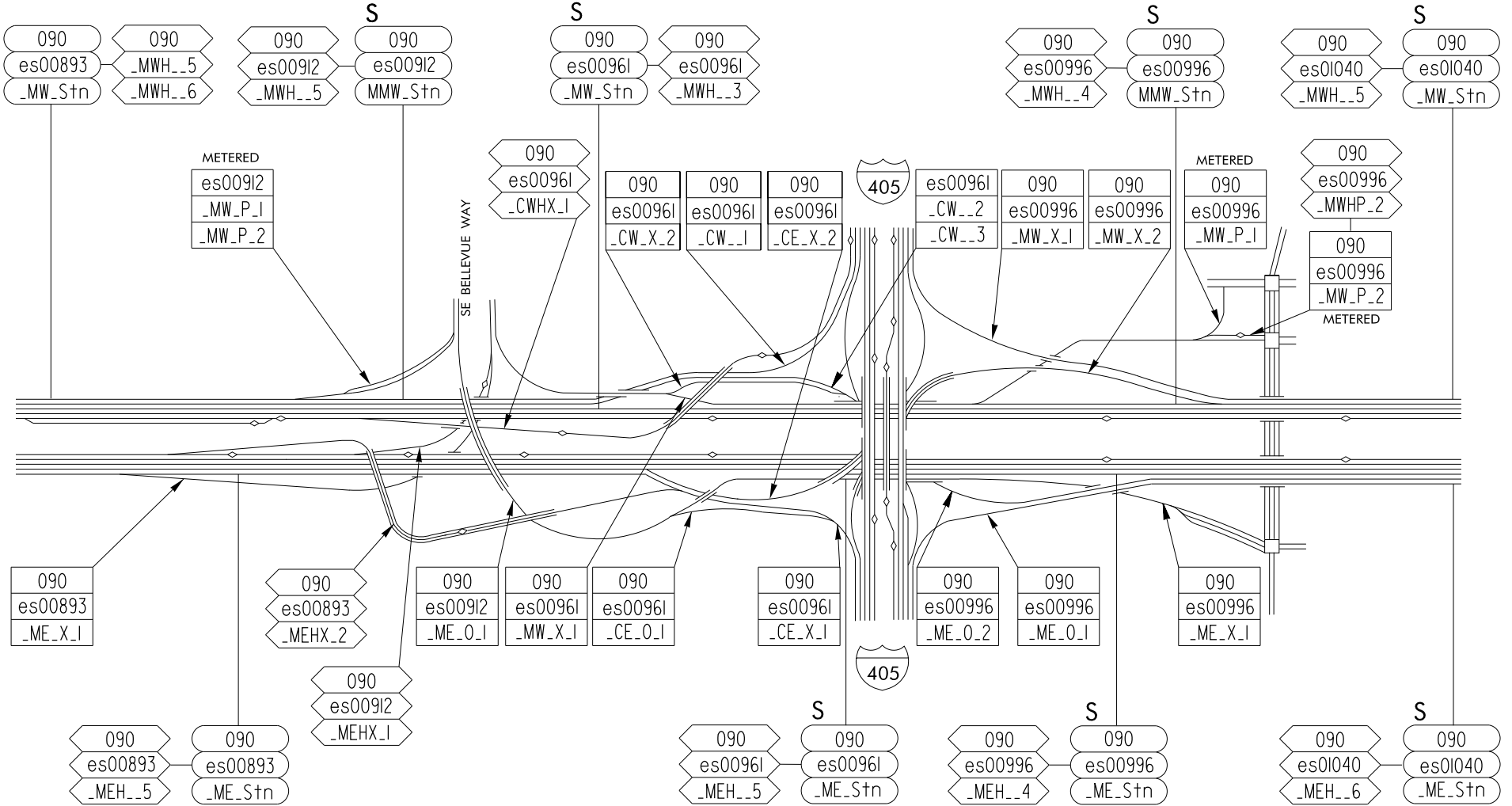

Washington State Department of Transportation

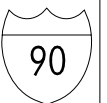

5 OF 11

142ND PL SE
 PARK & RIDE
 DIRECT ACCESS

EXIT 11A\B
 148TH AVE SE
 150TH AVE SE

EXIT 11
 161ST AVE SE
 S

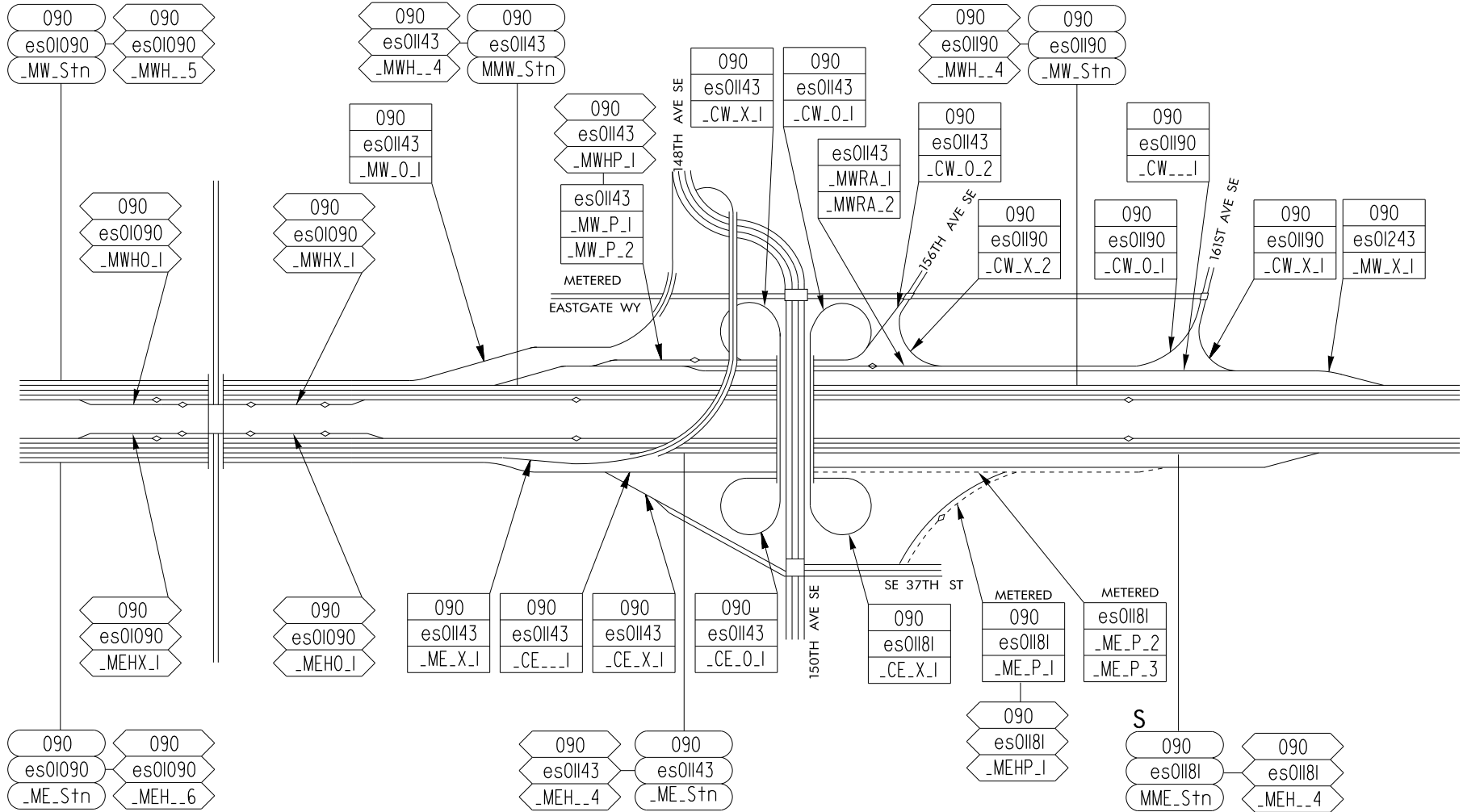

Washington State
 Department of Transportation



EXIT 13

164TH AVE SE

169TH AVE SE

W LAKE SAMMAMISH PKWY
NEWPORT WAY

193RD AVE SE

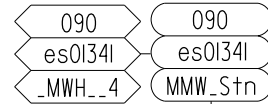
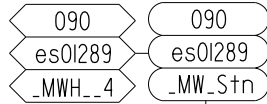
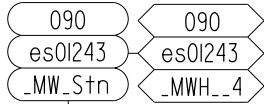

S

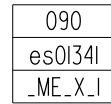
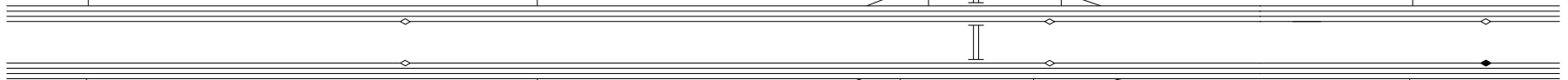
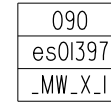
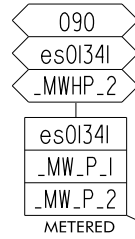
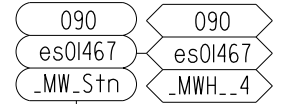
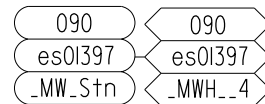

SE NEWPORT WY

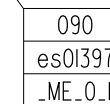

S

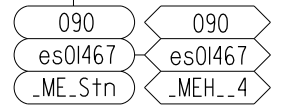
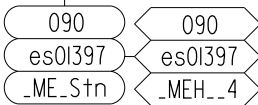
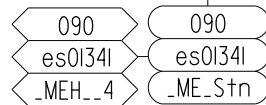
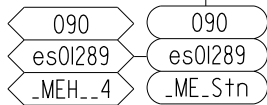
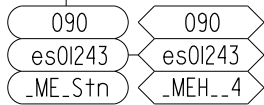

Washington State
Department of Transportation





200TH AVE SE

EXIT 15
SR 900
RENTON-
ISSAQUAH RD SE

12TH AVE NW

EXIT 17
FRONT ST
& E LAKE SAMM

EXIT 18
E SUNSET WY
& HIGHLANDS DR NE

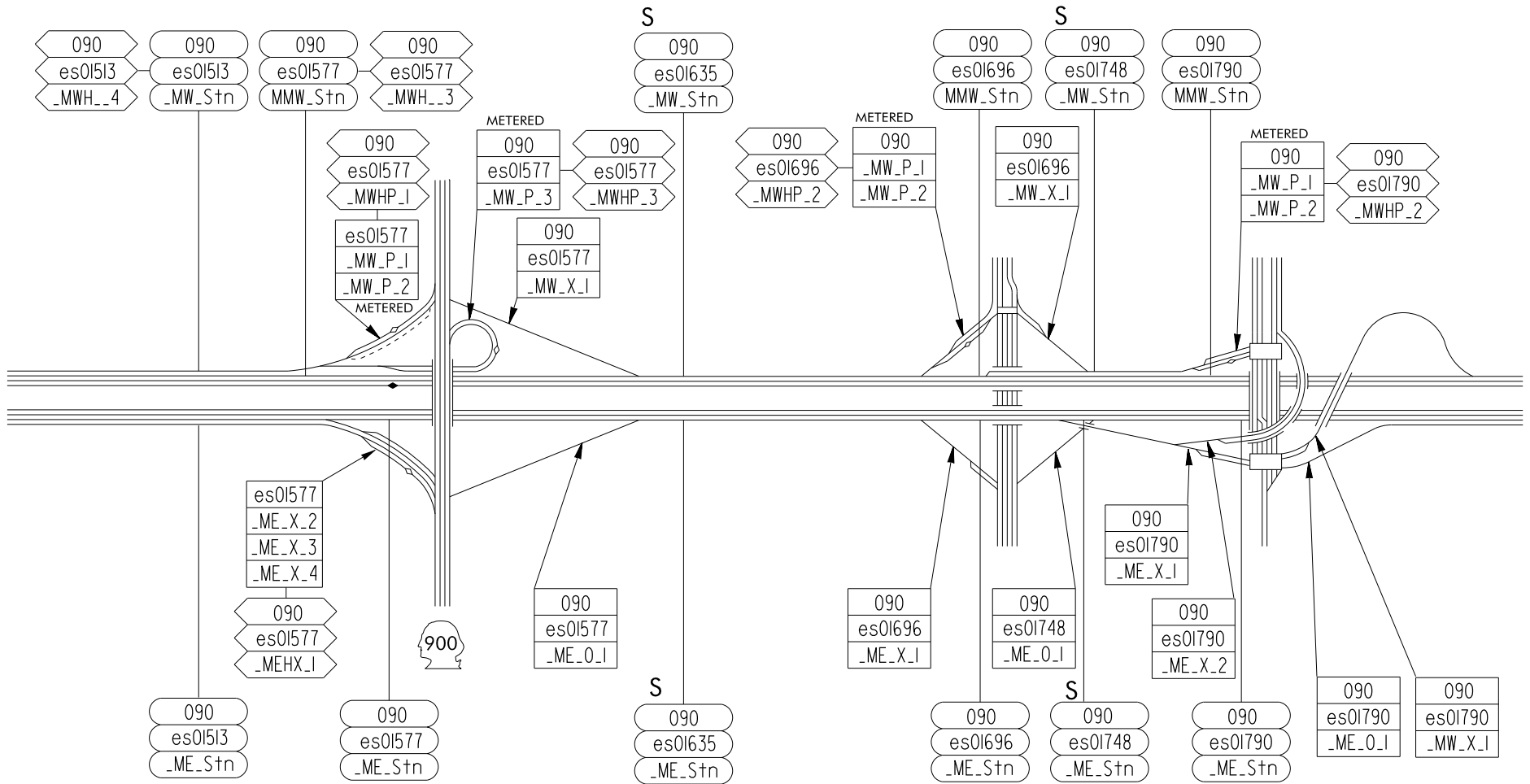

Washington State
Department of Transportation



8
OF
11



246TH AVE SE

256TH AVE SE

EXIT 20
HIGHPOINT RD
S 270TH AVE

S
090
es01864
_MW_Stn

S
090
es01941
_MW_Stn

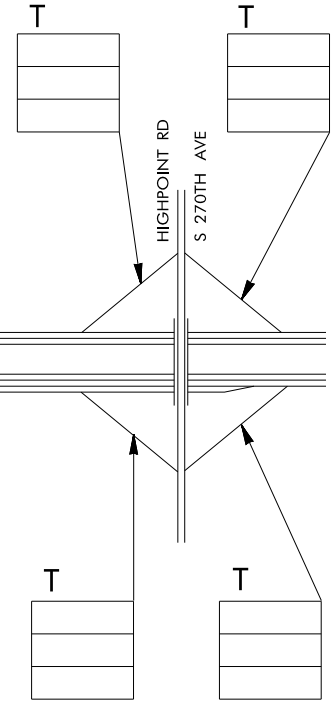

S
090
es01880
_ME_Stn

S
090
es01941
_ME_Stn



Washington State
Department of Transportation



9
OF
11



EXIT 22
PRESTON-
FALL CITY RD

EXIT 25
SR 18

EXIT 27
SE NORTH BEND WAY

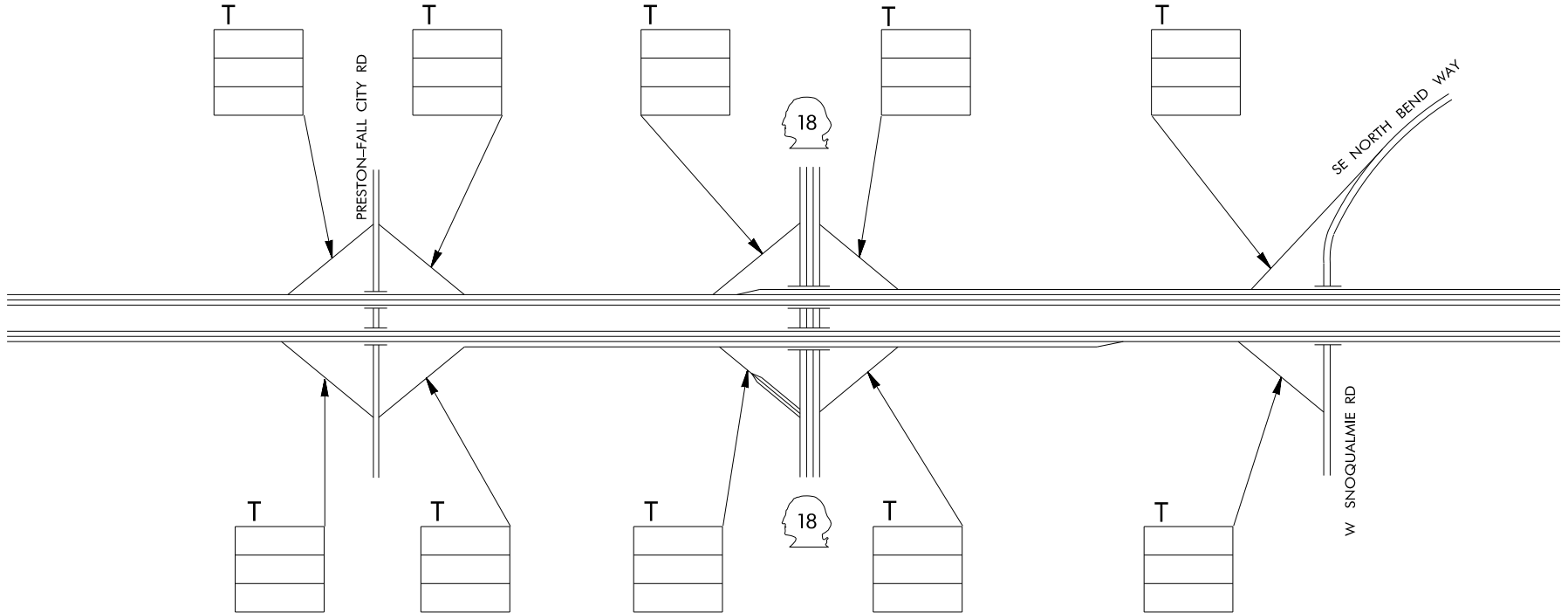

Washington State
Department of Transportation



10
OF
11

EXIT 31
SR 202

EXIT 32
436TH AVE SE

EXIT 34
EDGEWICK ROAD

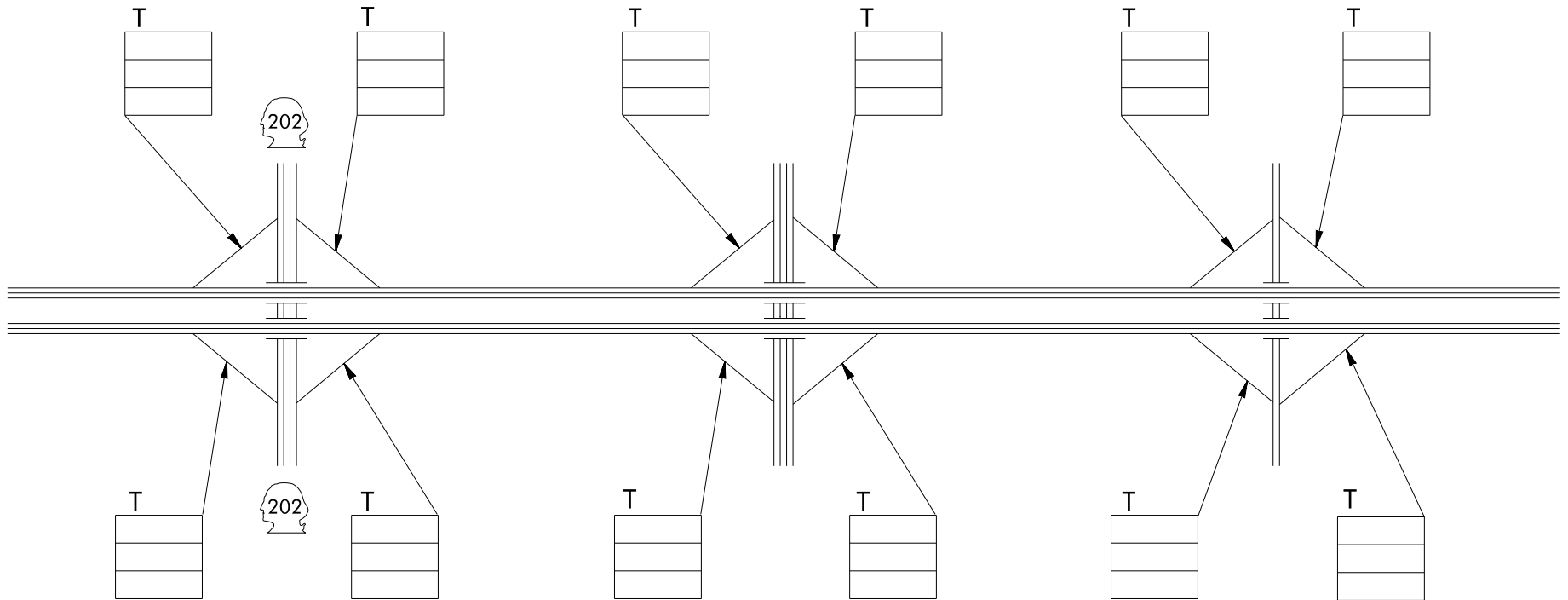

Washington State
Department of Transportation



11
OF
11

SR 599
PACIFIC HWY S

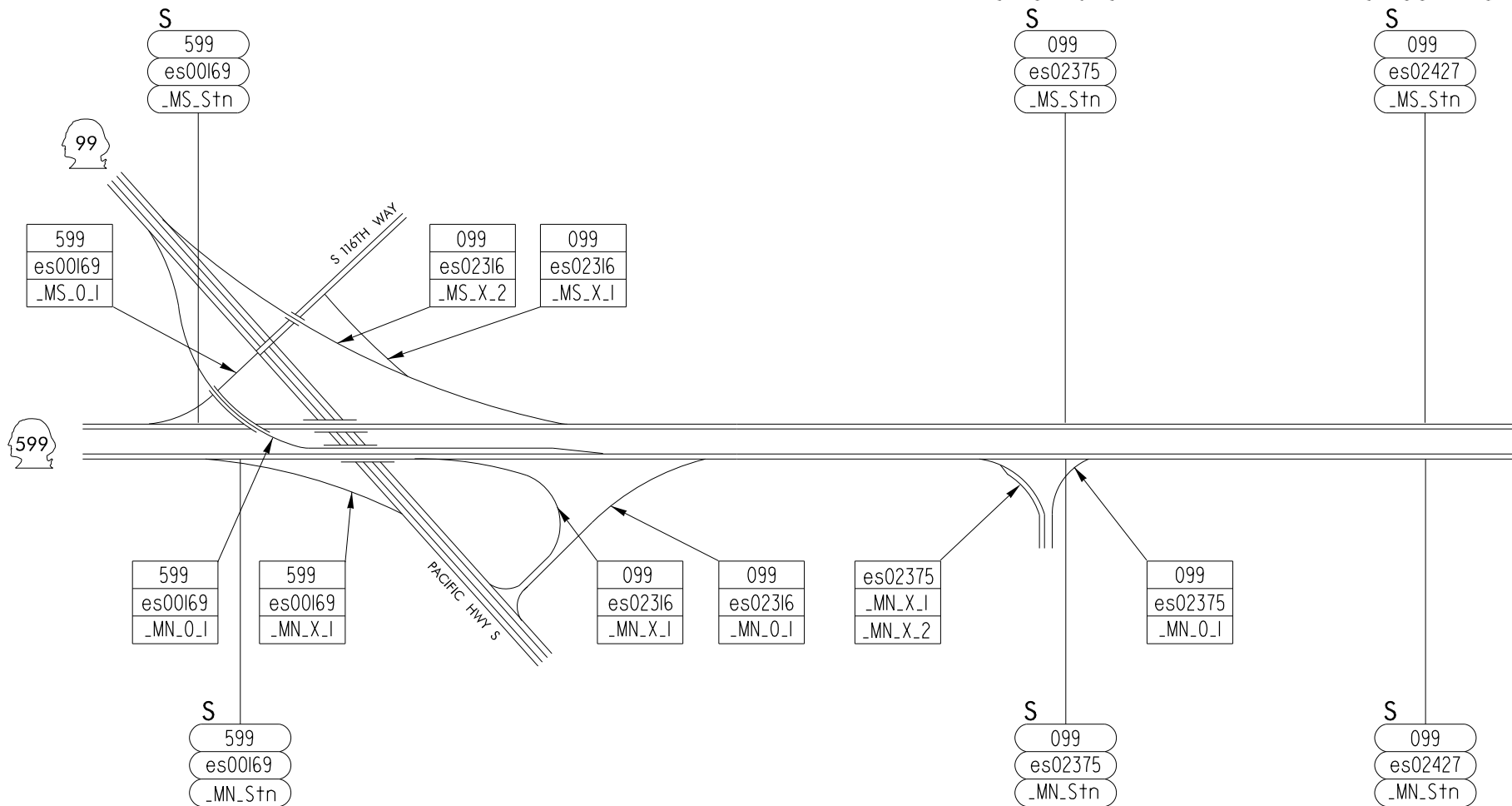

S
599
es00169
_MS_Stn

S 102nd ST
S
099
es02375
_MS_Stn

S 100TH ST
S
099
es02427
_MS_Stn

599
es00169
_MS_0_1

099
es02316
_MS_X_2

099
es02316
_MS_X_1

599
es00169
_MN_0_1

599
es00169
_MN_X_1

099
es02316
_MN_X_1

099
es02316
_MN_0_1

es02375
_MN_X_1
_MN_X_2

099
es02375
_MN_0_1

S
599
es00169
_MN_Stn

S
099
es02375
_MN_Stn

S
099
es02427
_MN_Stn



DES MOINES MEMORIAL DR
14TH AVE S

S CLOVERDALE ST

S KENYON ST

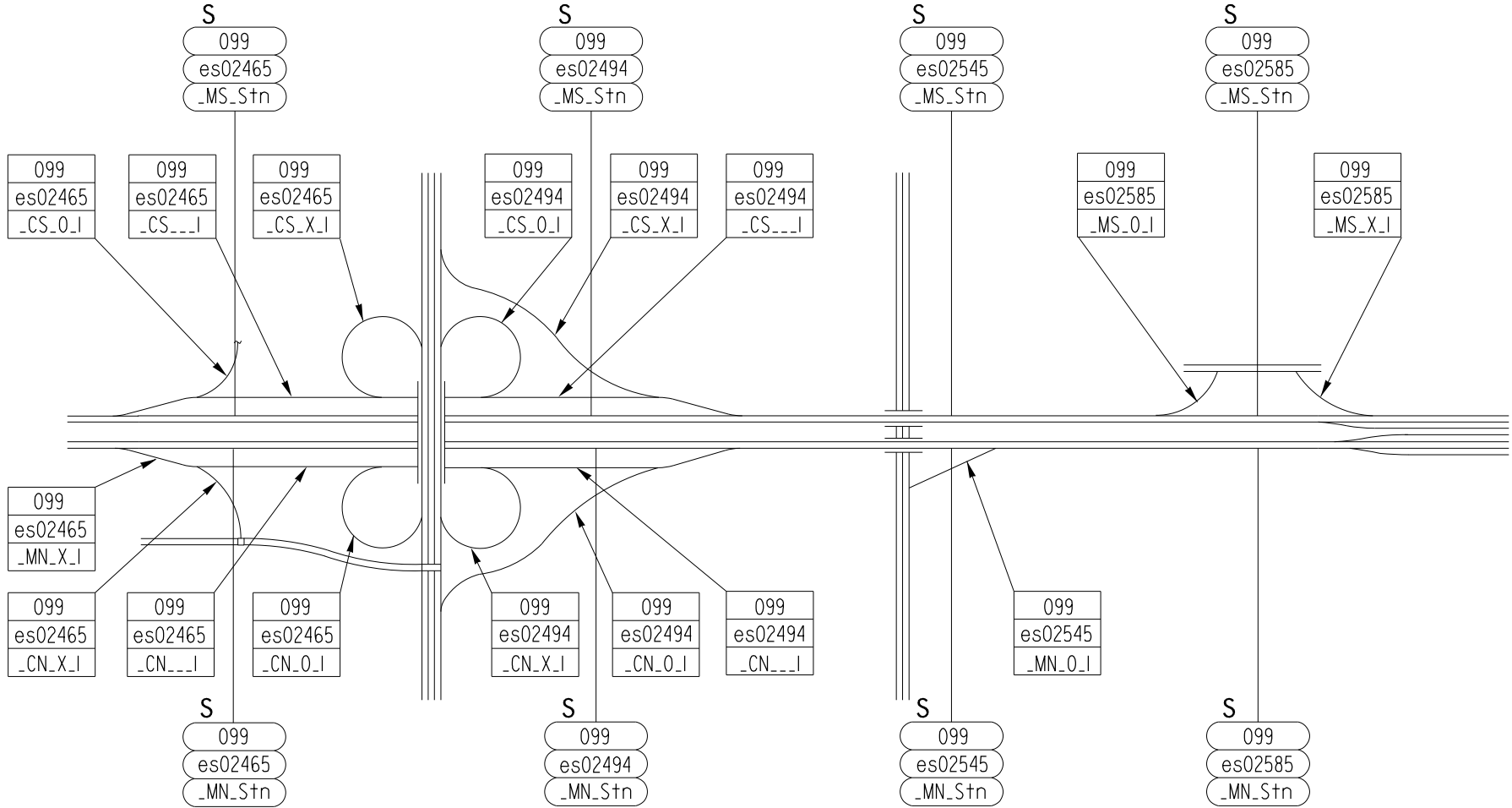

SR 509
S HOLDEN ST



1ST AVE BRIDGE S

509
es02976
_MS_Stn

509
es02976
_MSH_3

509
es02976
_MS_0_1

509
es02976
_MS_X_1

509

99

509
es02976
_MN_X_1

99

es02976
_MN_0_1
_MN_0_2

509
es02976
_MN_Stn

509
es02976
_MNH_3



Washington State
Department of Transportation

99

3
OF
3



3rd Ave SE

Ellingson Rd

S
167
es01127
_MS_Stn

S
167
es01169
_MS_Stn

S
167
es01245
_MS_Stn

S
167
es01287
_MS_Stn

S
167
es01215
MMS_Stn

167
es01215
_MSH_P_I

167
es01215
_MS_P_I
METERED

167
es01245
_MS_X_I

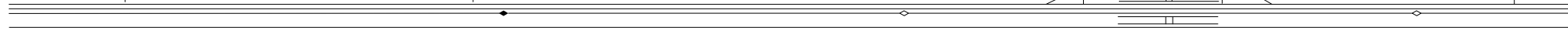

S
167
es01127
_MN_Stn

S
167
es01169
_MN_Stn

167
es01215
_MN_X_I

S
167
es01215
_MN_Stn

S
167
es01245
MMN_Stn

METERED
167
es01245
_MN_P_I

167
es01245
_MNH_P_I

S
167
es01287
_MN_Stn



Washington State
Department of Transportation



1
OF
6

7TH Ave N

15TH ST SW

SR 18

S

15TH ST NW

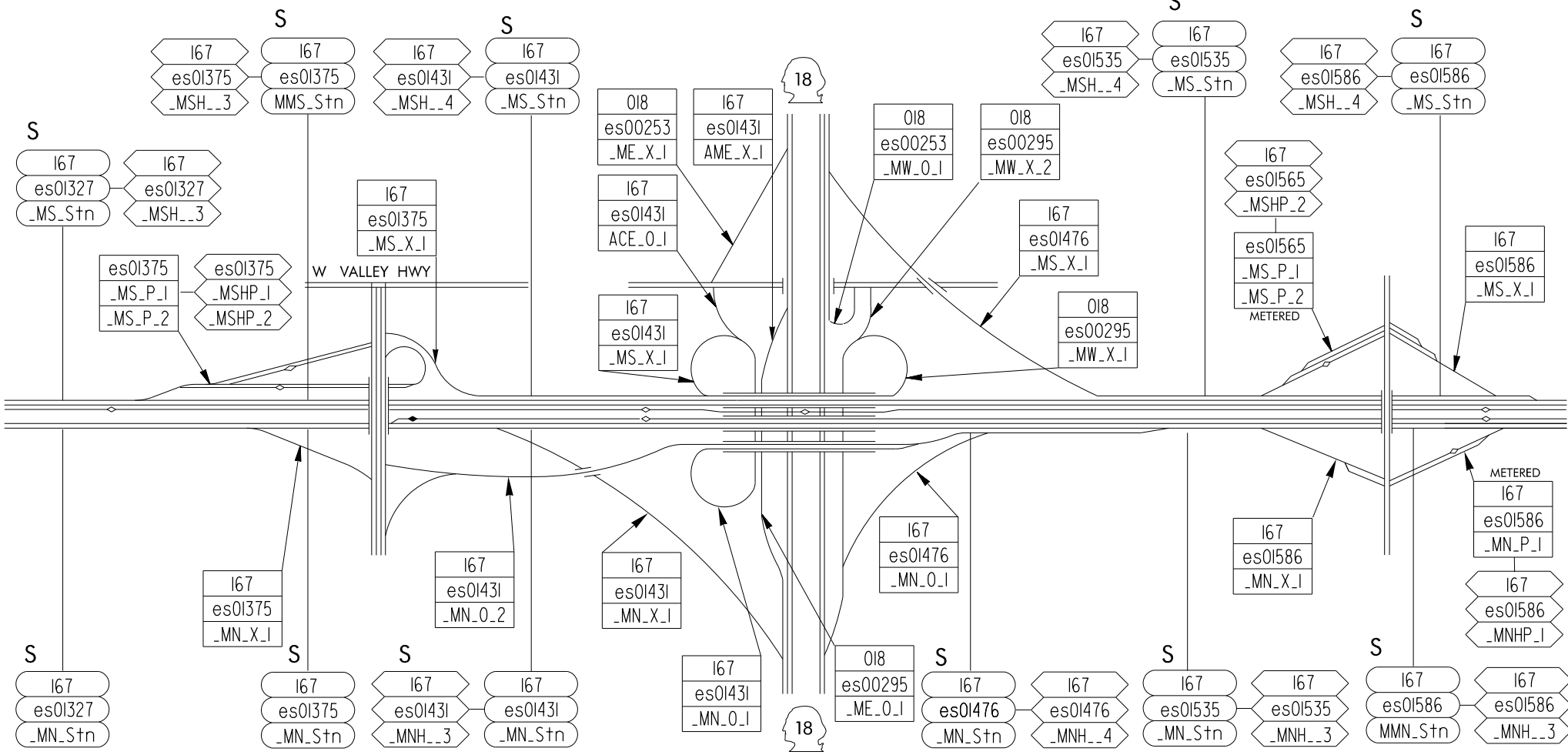



Emerald Downs

34TH ST NW

37TH ST NW

S 277TH ST

S 269TH ST

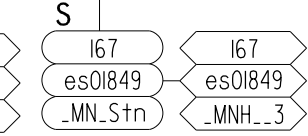
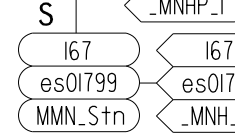
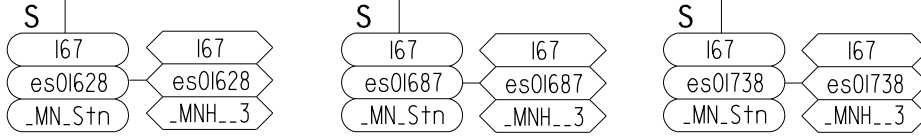
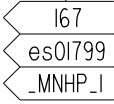
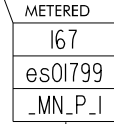
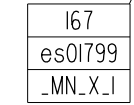
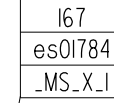
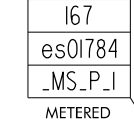
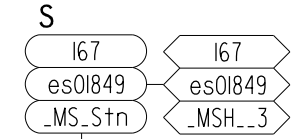
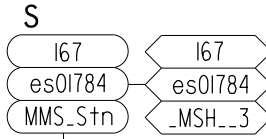
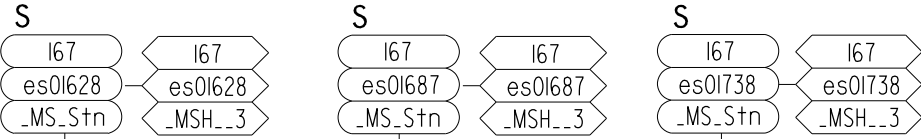

Washington State Department of Transportation





GREEN RIVER

SR 516 WILLIS ST

JAMES ST

4TH AVE

84TH AVE S CENTRAL AVE

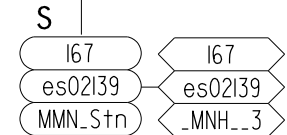
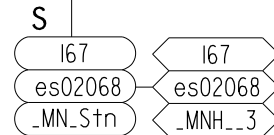
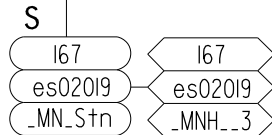
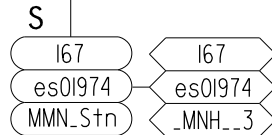
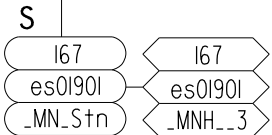
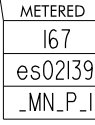
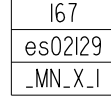
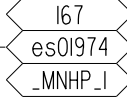
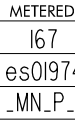
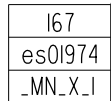
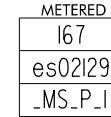
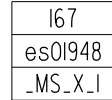
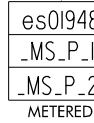
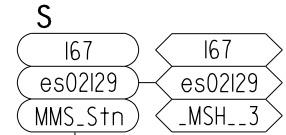
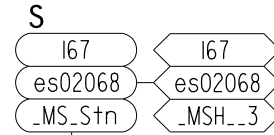
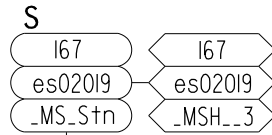
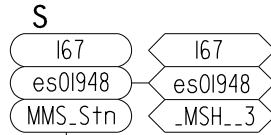
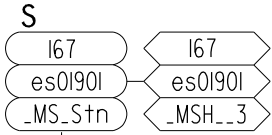

Washington State Department of Transportation



S 222ND ST

S 212TH ST

S 204TH ST

S 196TH ST

S 188TH ST

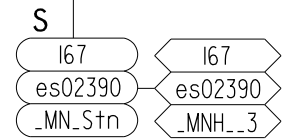
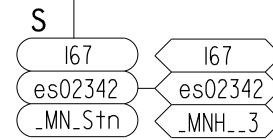
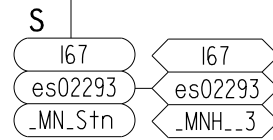
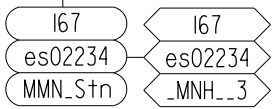
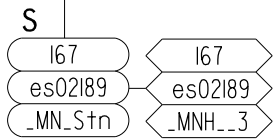
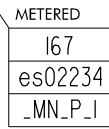
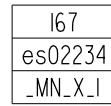
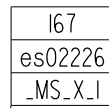
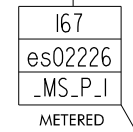
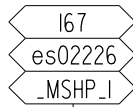
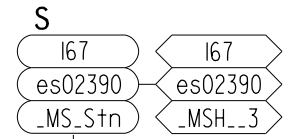
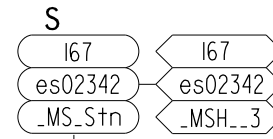
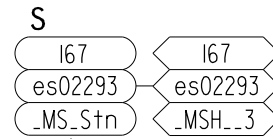
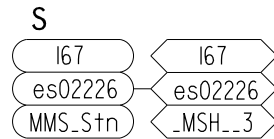
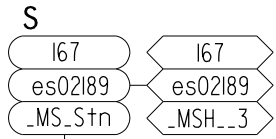

Washington State
Department of Transportation



5
OF
6

S 180TH ST

SW 41ST ST

S 34TH ST

S 23RD ST

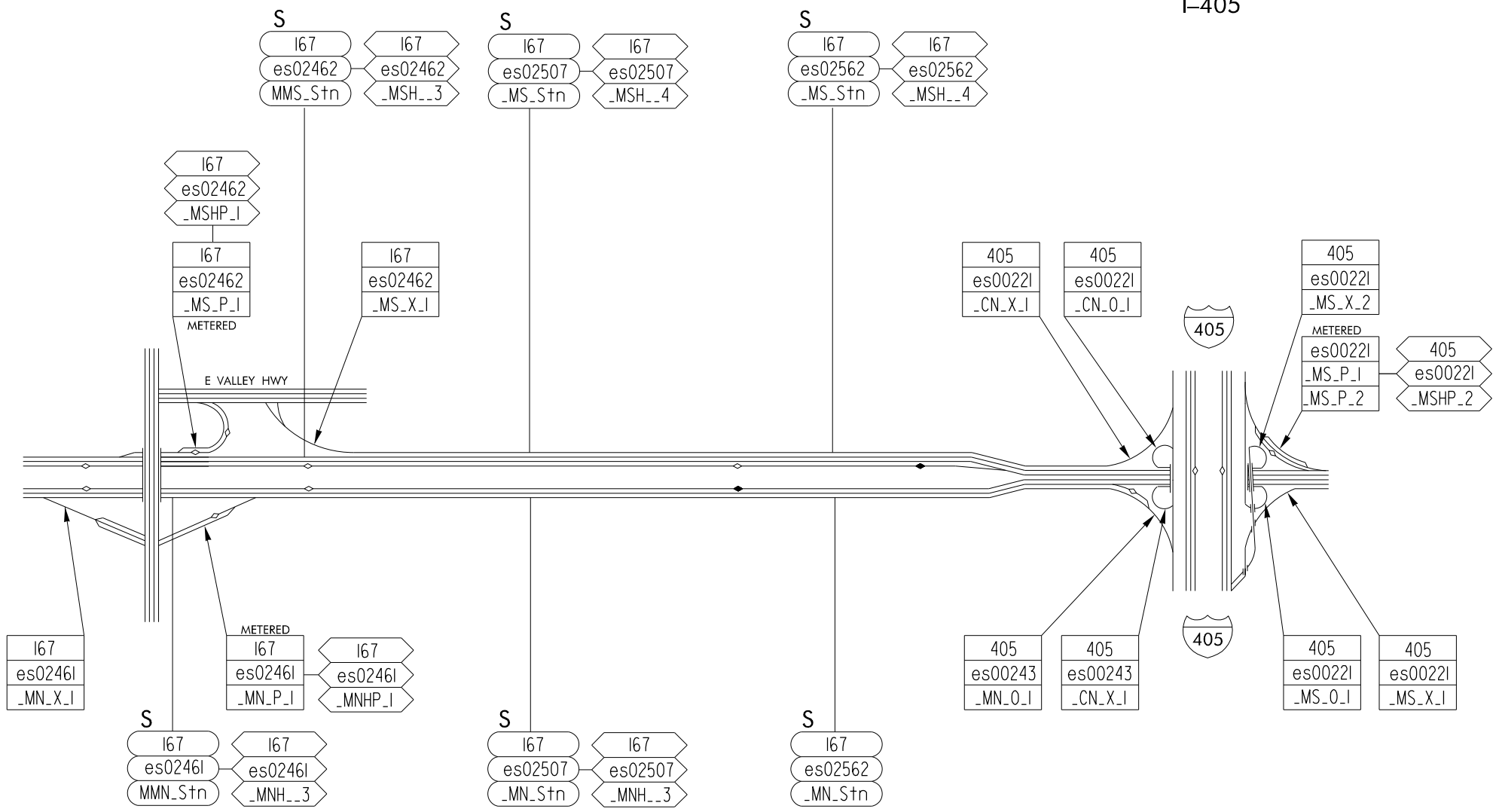
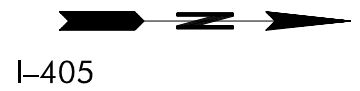



I-5
(TUKWILA)

ANDOVER PARK W

INTERURBAN AVE S

EXIT 1
SR 181
WEST VALLEY HWY

LONGACRES DR SW

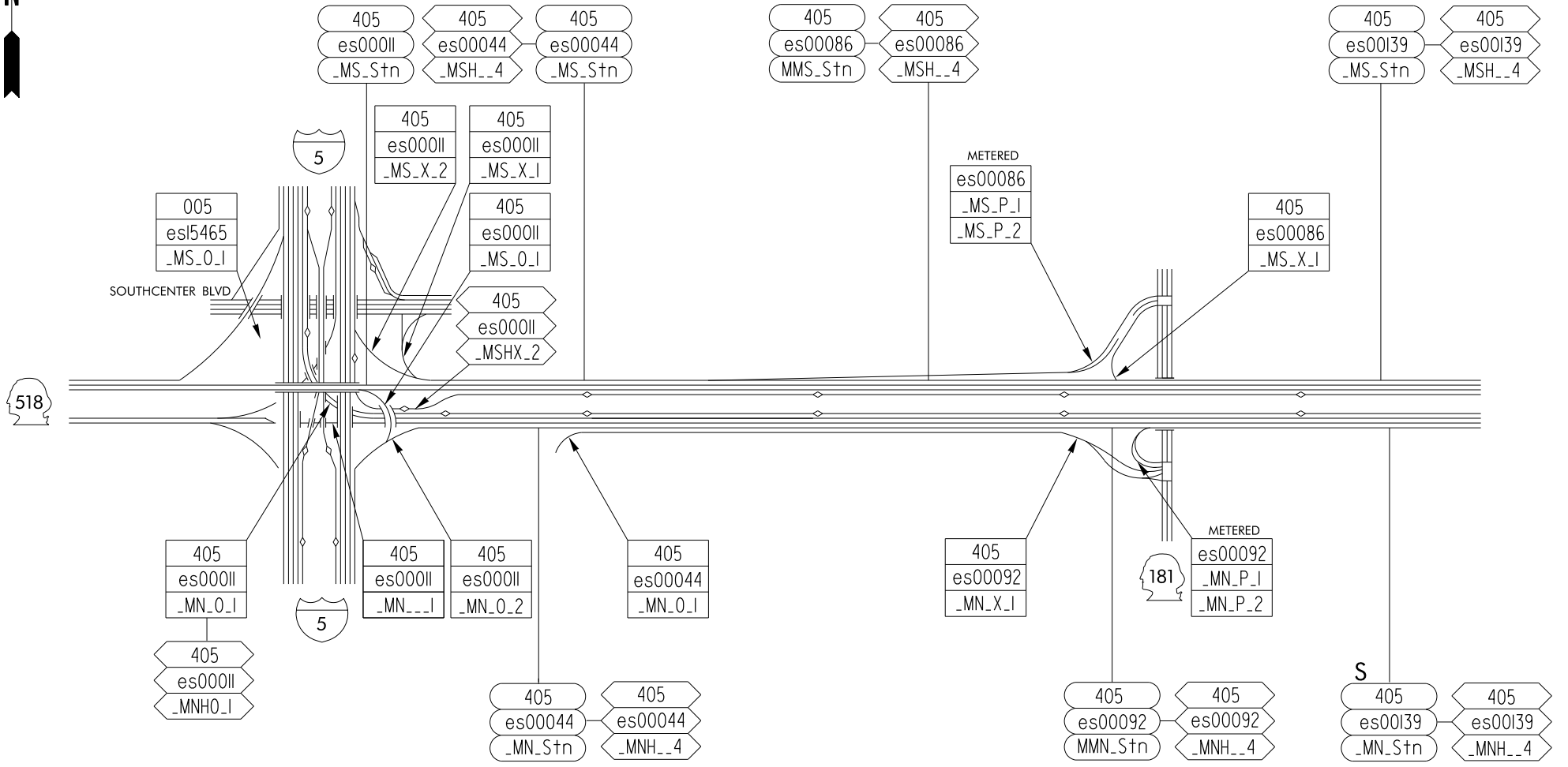

EXIT 2

POWELL AVE SW

SR 167
RAINIER AVE S / VALLEY FWY

TALBOT RD
SR 515

S 9TH ST

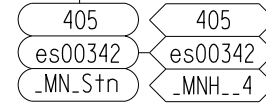
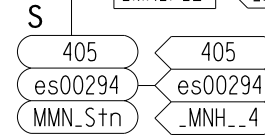
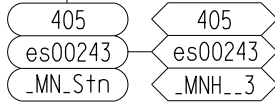
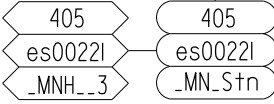
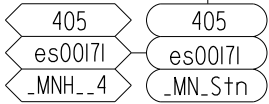
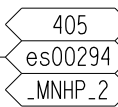
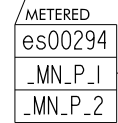
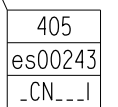
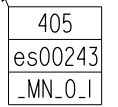
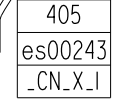
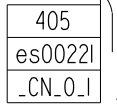
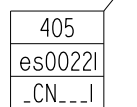
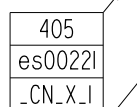
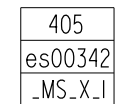
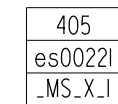
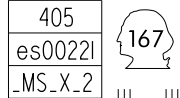
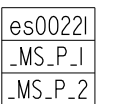
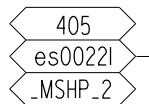
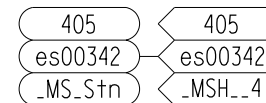
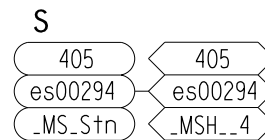
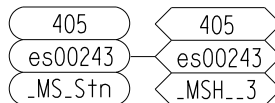
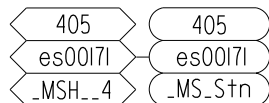

Washington State
Department of Transportation



2
OF
16

EXIT 4
SR 169
MAPLE VALLEY RD

EXIT 4
SR 900
SUNSET BLVD

EXIT 5
SR 900
NE PARK DR

NE 24TH ST

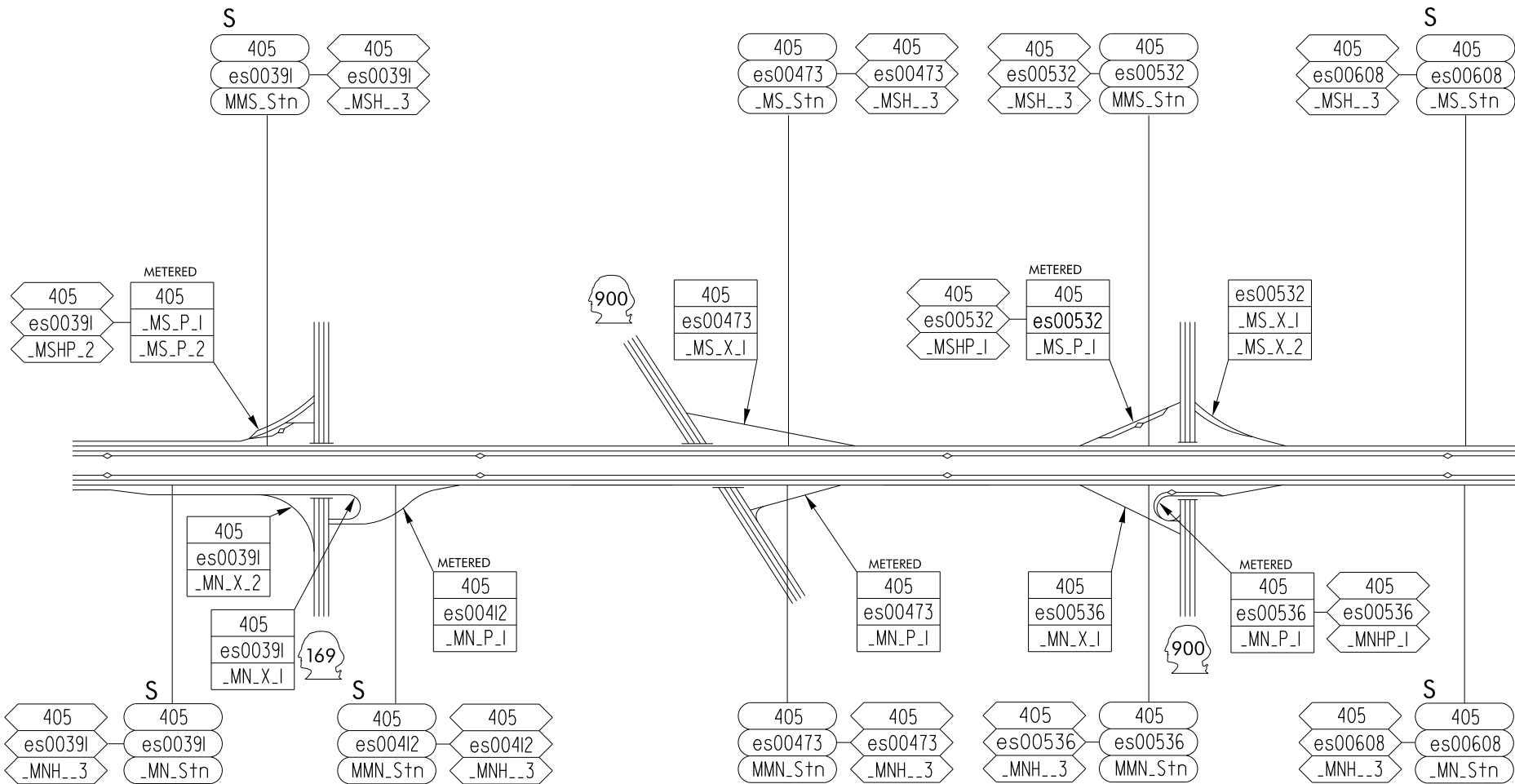

EXIT 6

NE 30TH ST

EXIT 7

NE 44TH ST

SE 72ND ST

SE 64TH ST



NE 37TH ST
KENNYDALE HILL

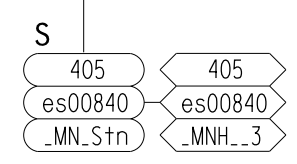
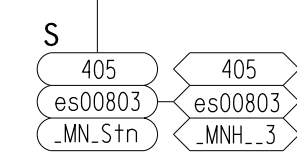
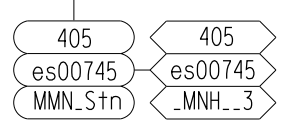
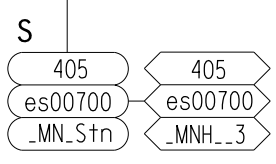
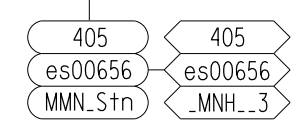
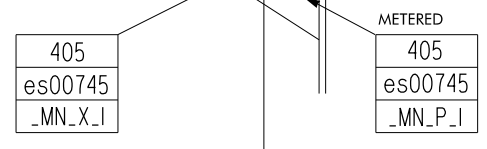
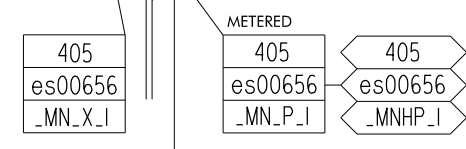
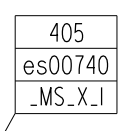
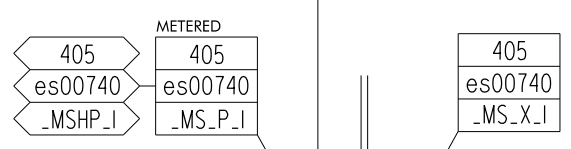
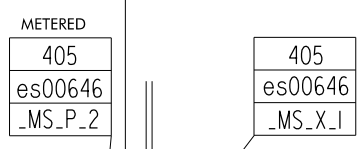
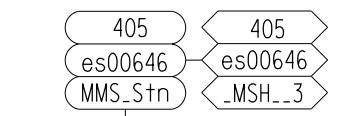
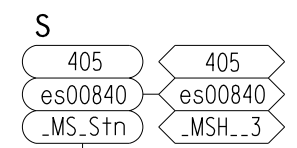
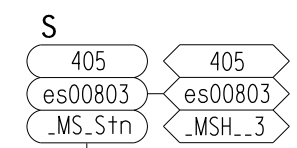
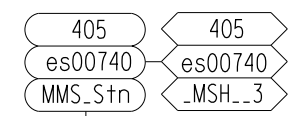
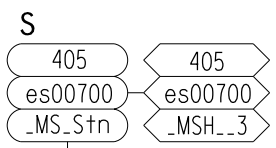



SE 59TH ST

S

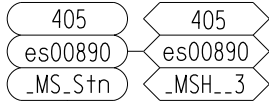

EXIT 9

SE 52ND ST
112TH AVE SE

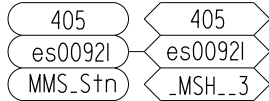

METERED

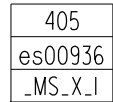
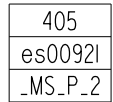

SE 47TH ST

S

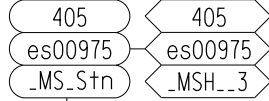

EXIT 10

COAL CREEK PKWY

S

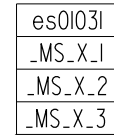
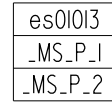
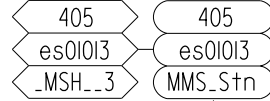

S

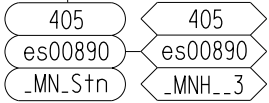

S

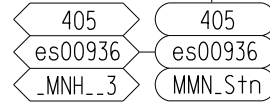

METERED

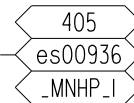
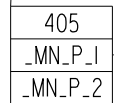

S

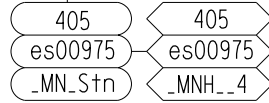

Washington State
Department of Transportation



5
OF
16



SE 39TH ST

EXIT 11

I-90

SE 24TH ST

SE 17TH ST

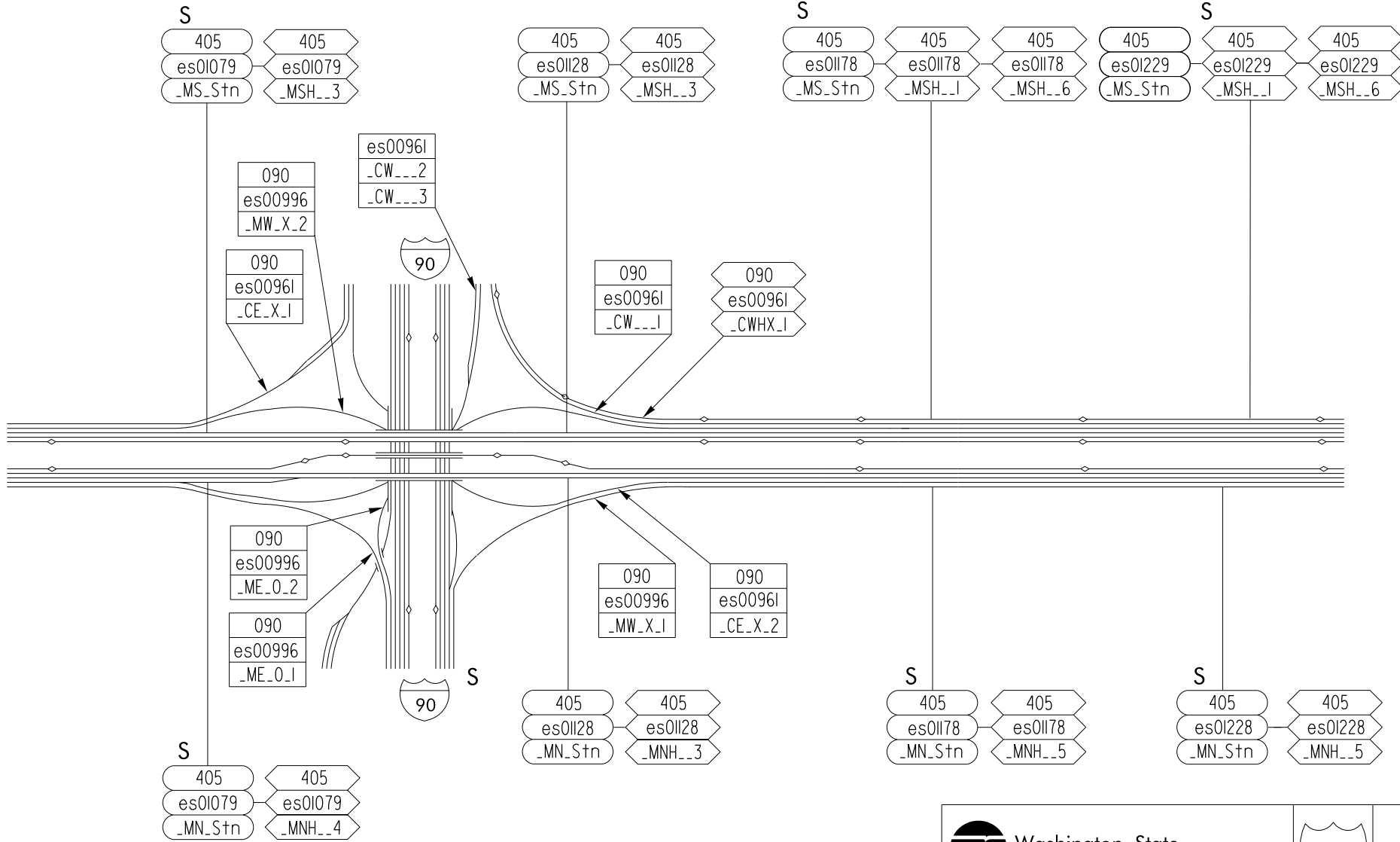

Washington State Department of Transportation



6 OF 16

EXIT 12
SE 8TH ST

MAIN ST

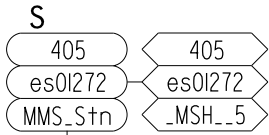

METERED

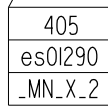
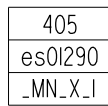
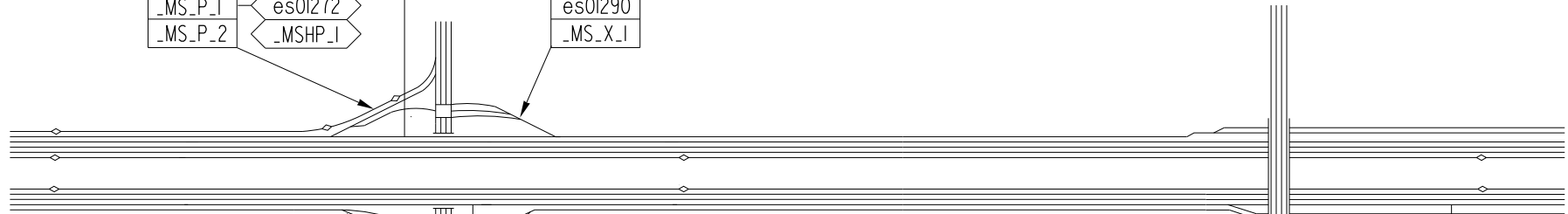
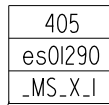
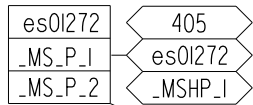

116th Ave SE

METERED

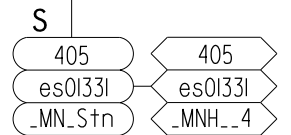
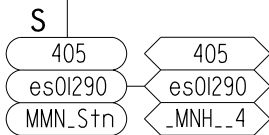
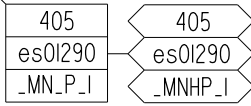

Washington State
Department of Transportation



7
OF
16

EXIT 13A
NE 4TH ST

HOV ONLY EXIT
NE 6TH ST

EXIT 13B
NE 8TH ST

NE 10TH ST

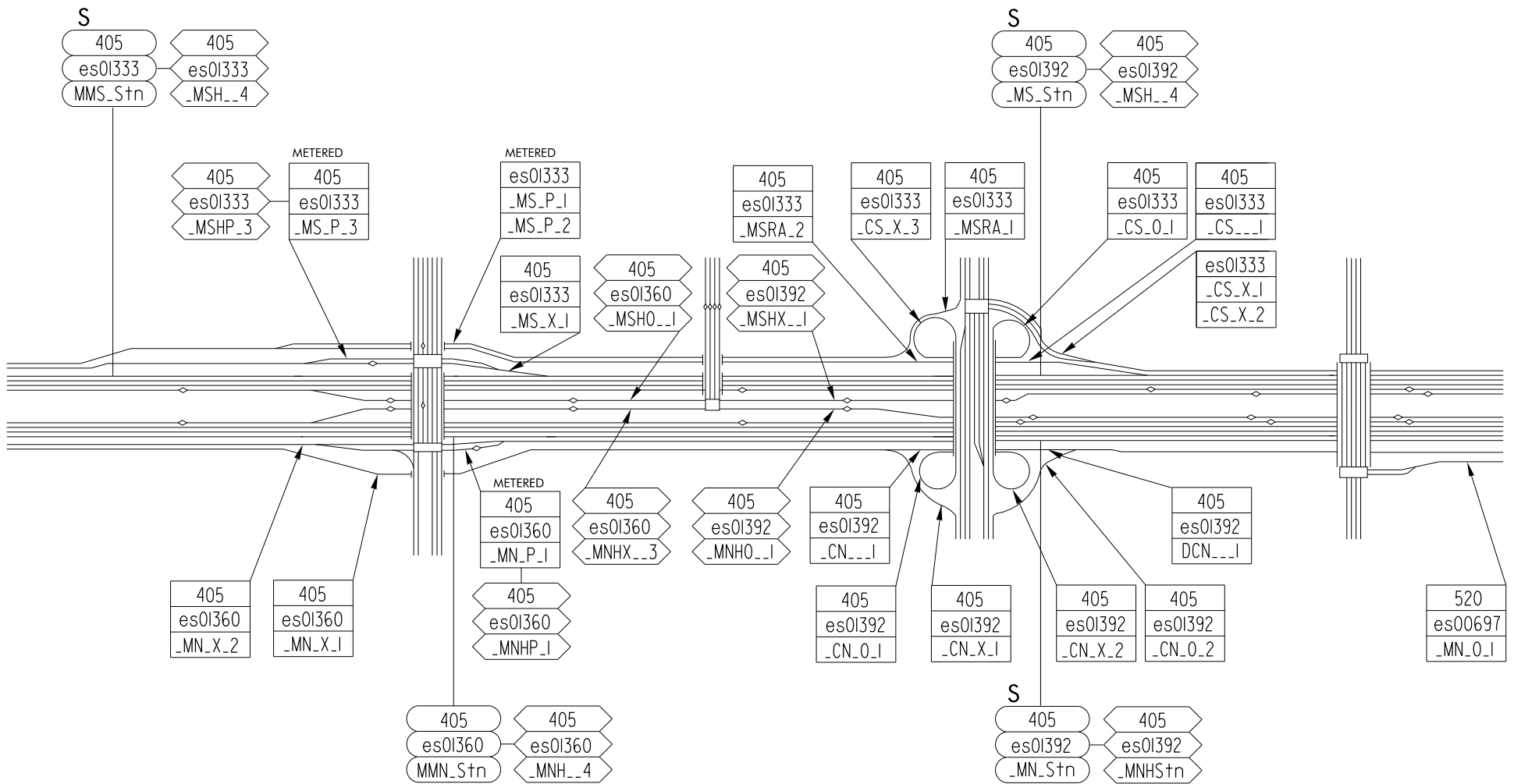

Washington State
Department of Transportation



8
OF
16



EXIT 14

NE 14TH ST

SR 520
(NORTHUP)

NE 28TH ST

NE 37TH ST

NE 46TH ST

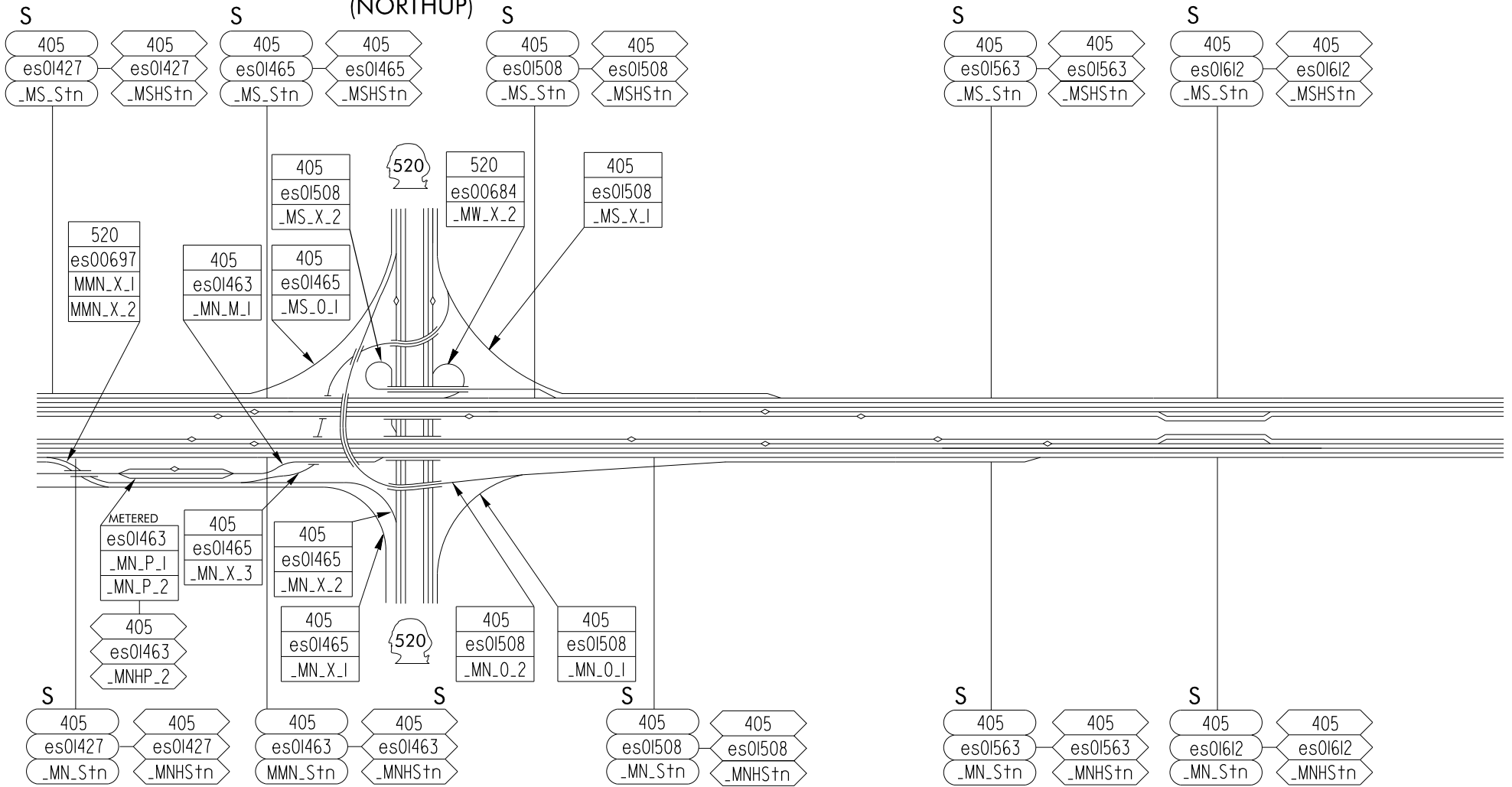

NE 57TH ST

EXIT 17
NE 70TH PL

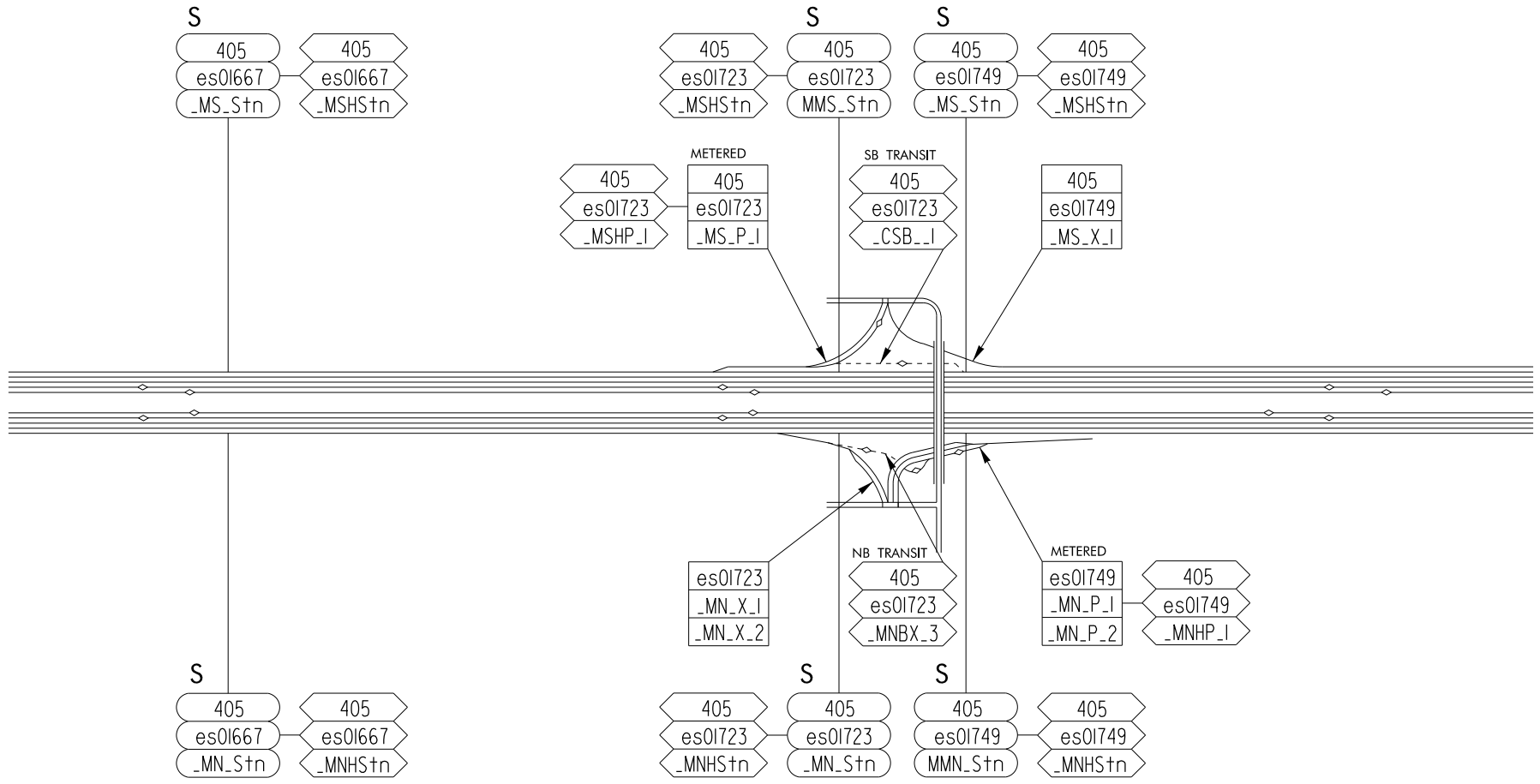



EXIT 18

NE 85TH ST
(SR 908)

NE 97TH ST

NE 106TH ST

S

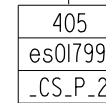
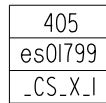
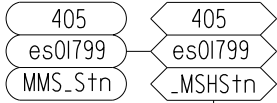

METERED

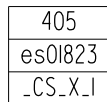

METERED

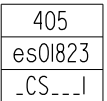
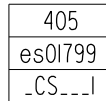
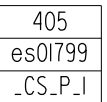

S

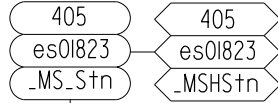

S

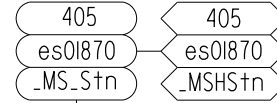

S

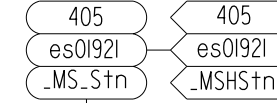

S

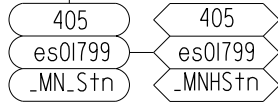

METERED

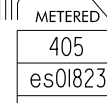

METERED



S

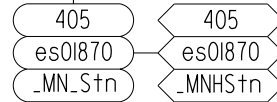
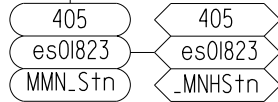

S

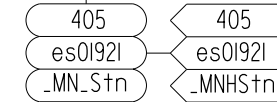

Washington State
Department of Transportation





EXIT 20A
NE 116TH ST

EXIT 20\20B
NE 124TH ST
(TOTEM LAKE)

NE 128TH ST

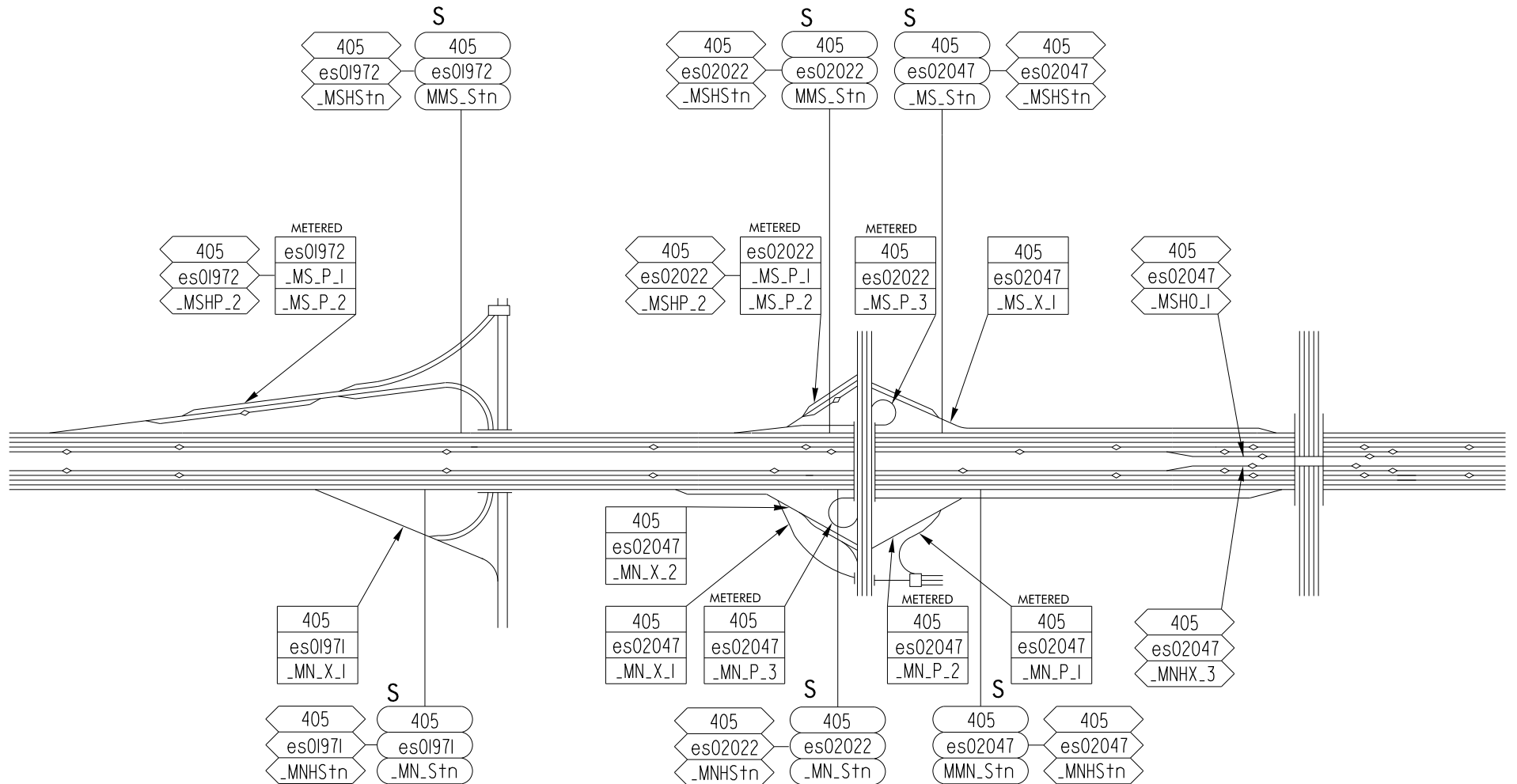



NE 132ND ST NE 140TH ST NE 144TH ST

EXIT 22

NE 160TH ST
JUANITA-WOODINVILLE WY NE

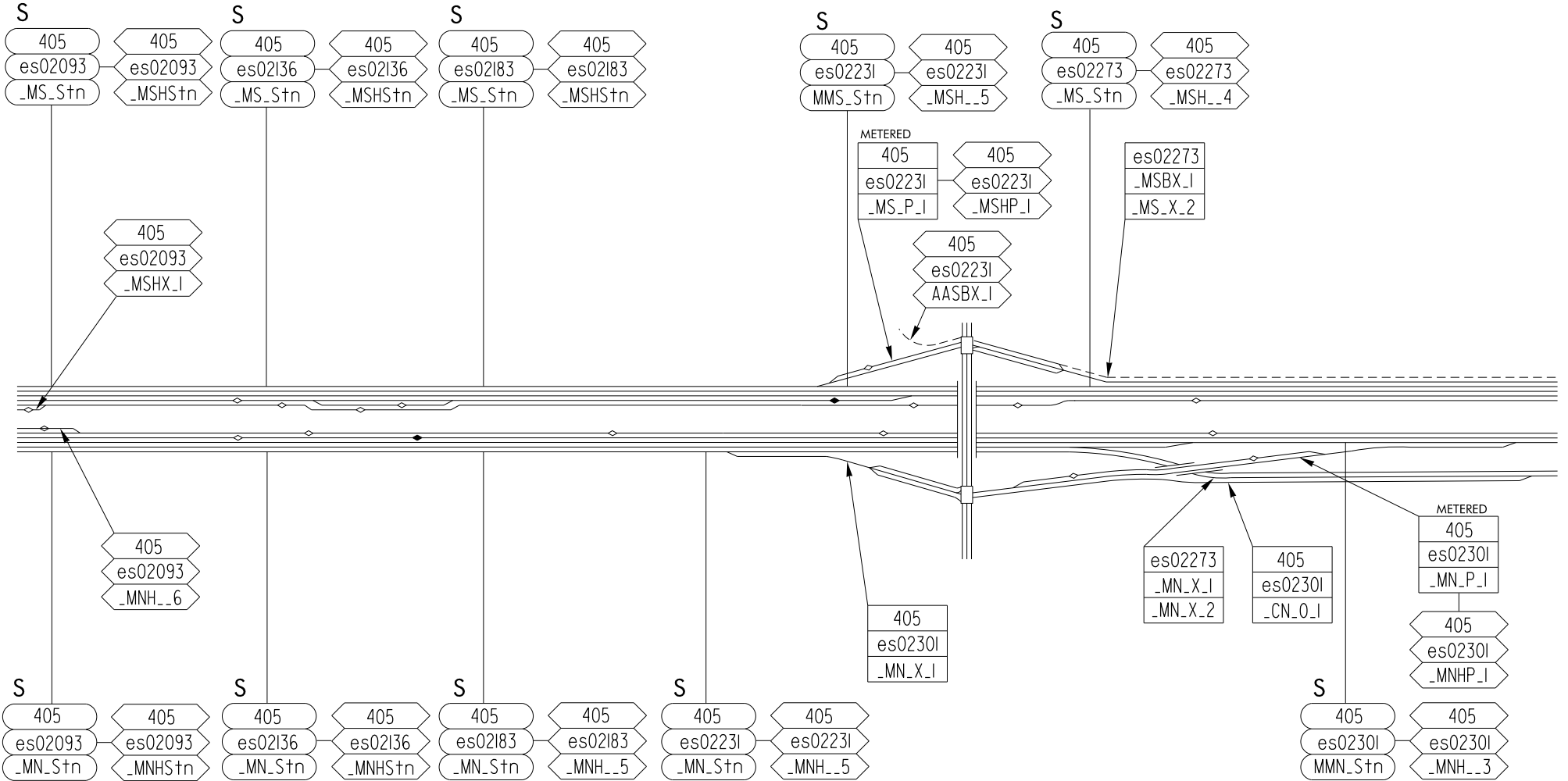

EXIT 23
SR 522
(WOODINVILLE)

EXIT 24
NE 195TH ST
BEARDSLEE BLVD

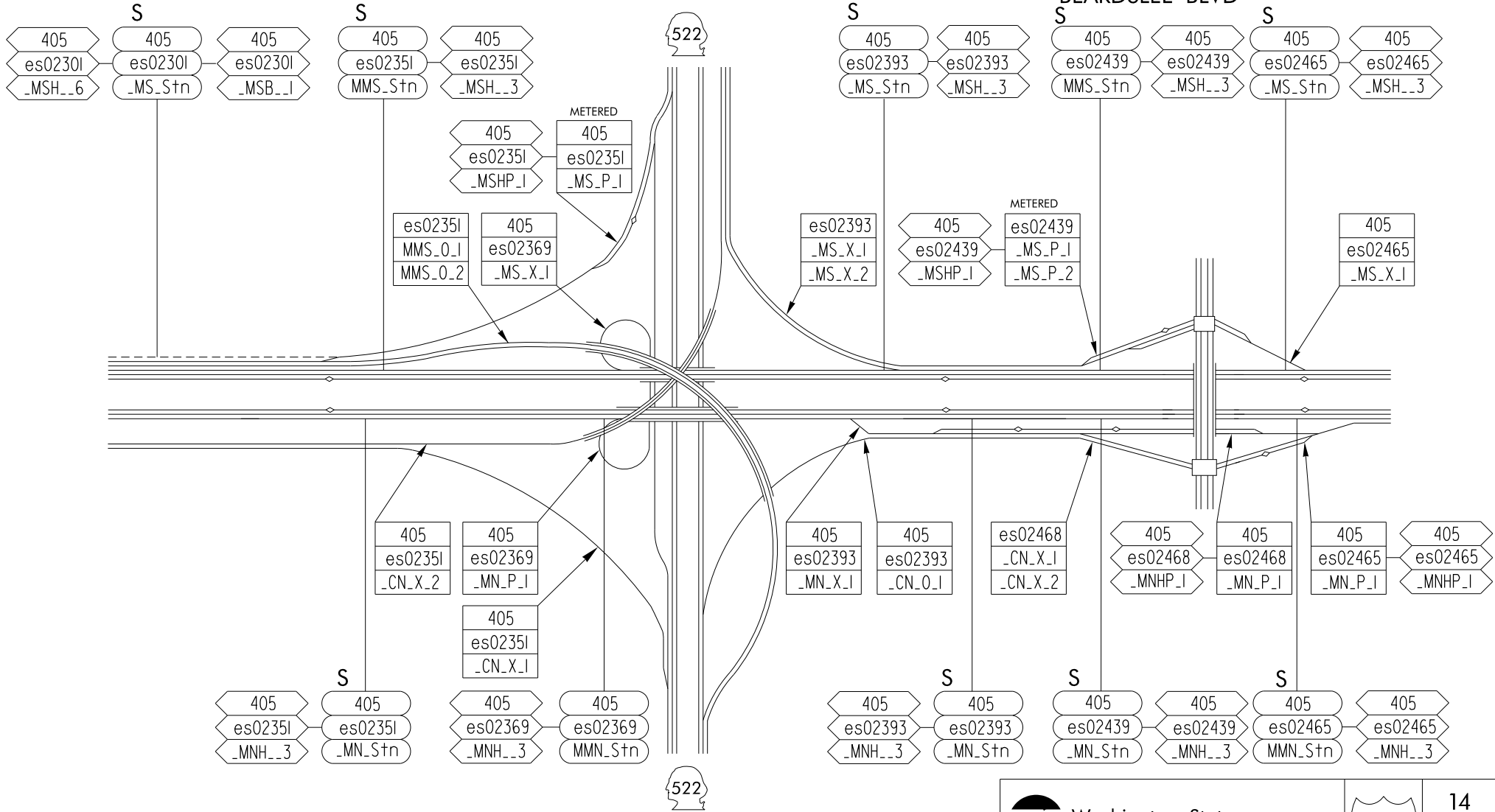

EXIT 26

SR 527

BOTHELL - EVERETT HWY

242ND ST SE

236TH ST SE

230TH ST SE

216TH ST SE

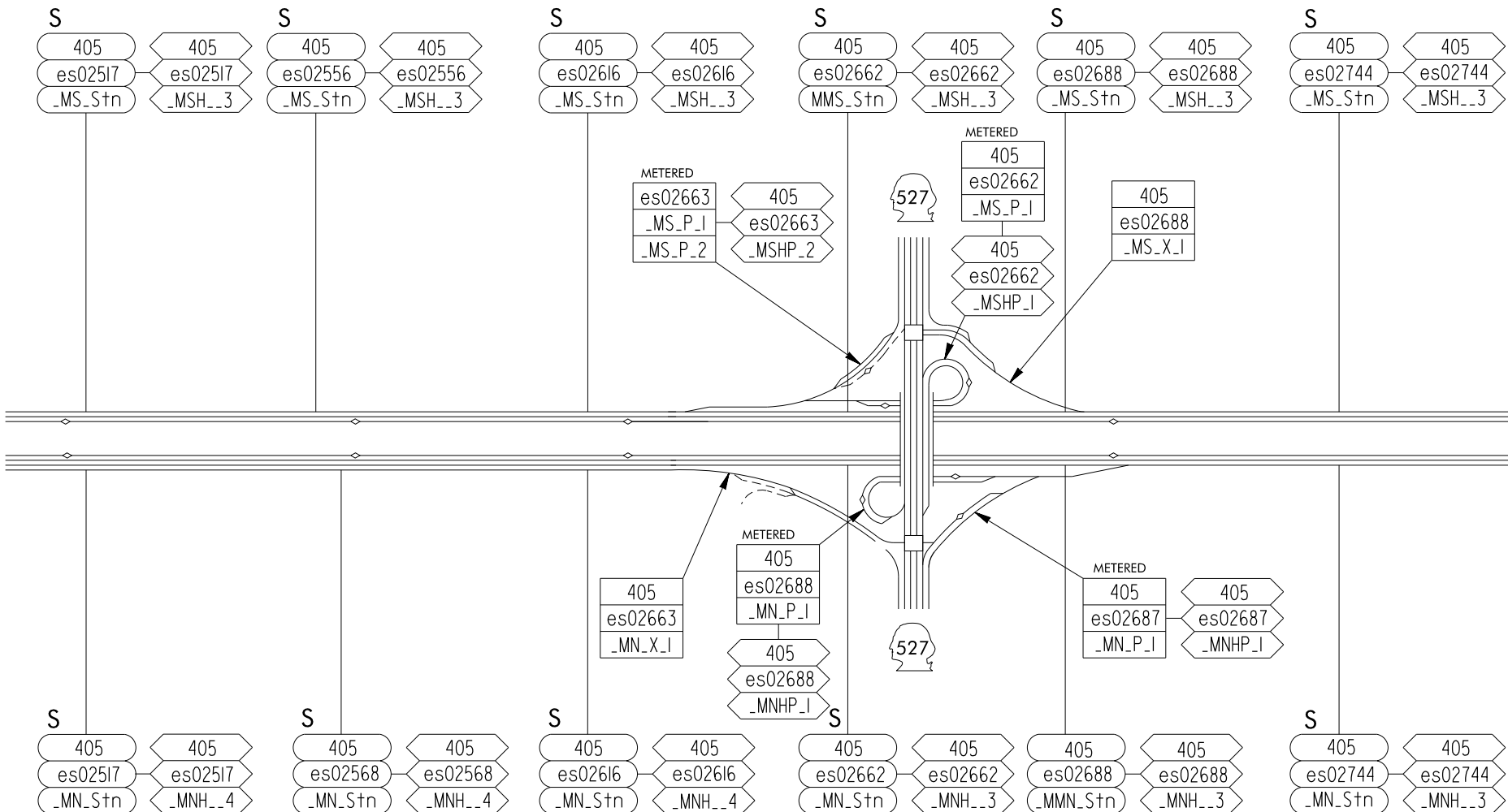
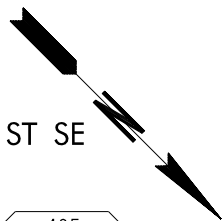

Washington State Department of Transportation



15 OF 16

208TH ST SE

200TH ST SE

DAMSON RD

FILBERT RD
SR 524

I-5
(SWAMP CREEK INTERCHANGE)

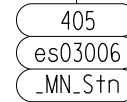
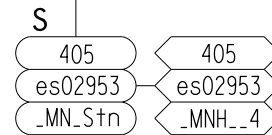
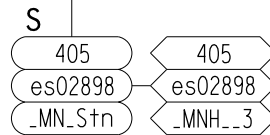
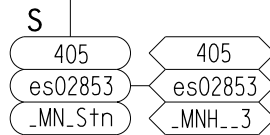
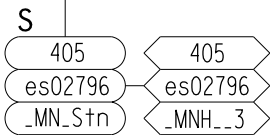
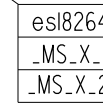
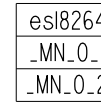
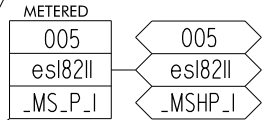
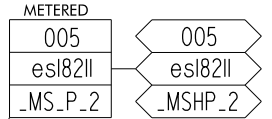
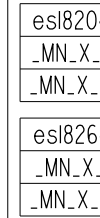
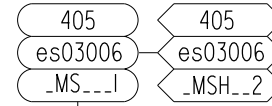
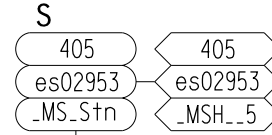
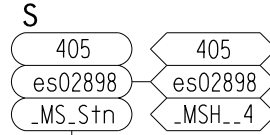
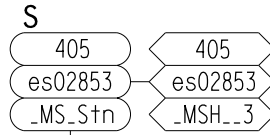
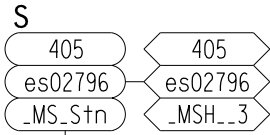
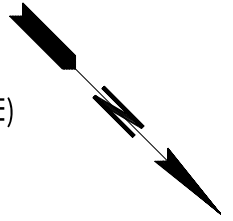

Washington State
Department of Transportation



S 188TH ST

S 160TH ST

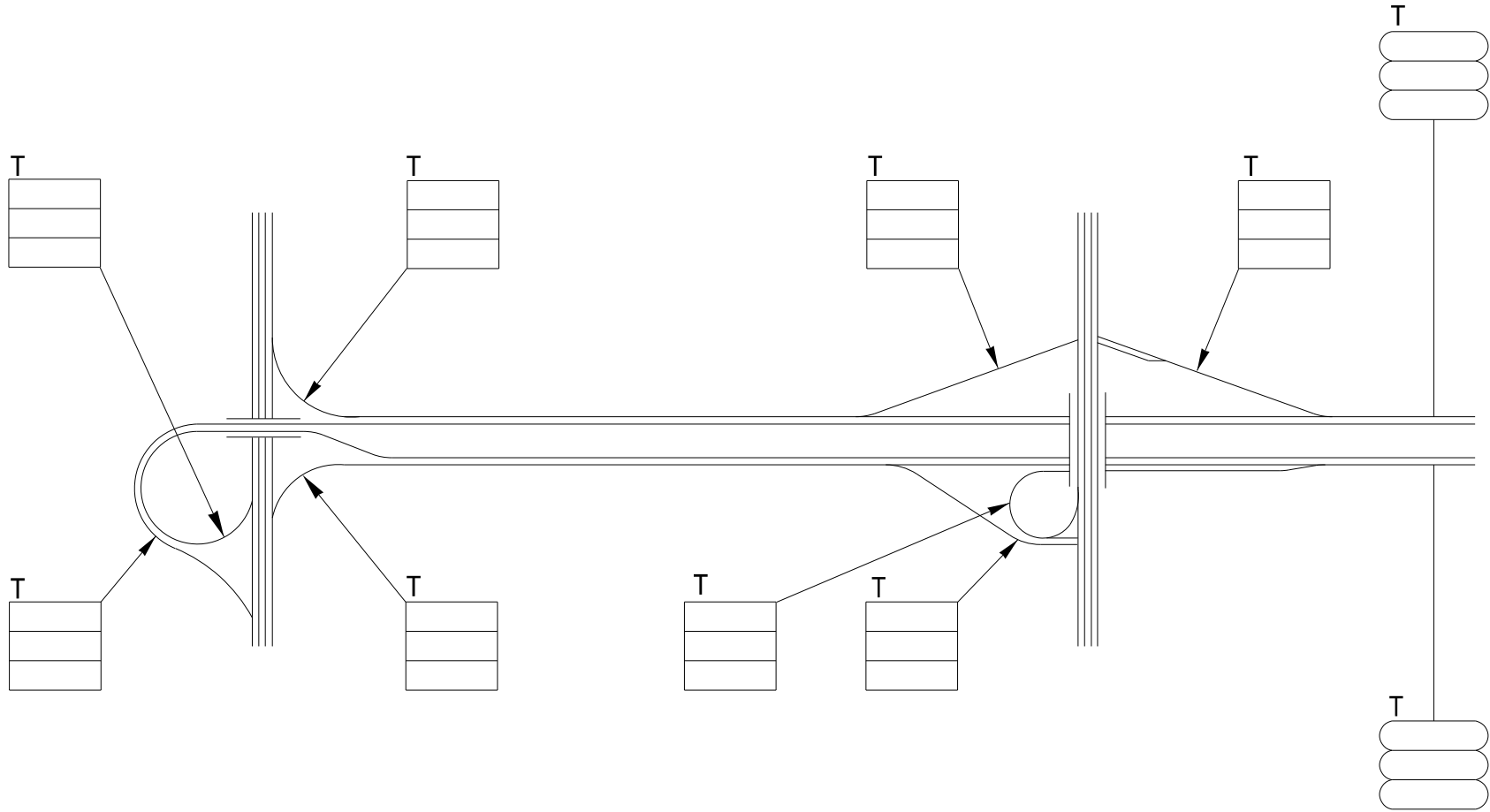

Washington State
Department of Transportation



1
OF
4

SR 518
SW 148TH ST

SW 146TH ST

SW 128TH ST

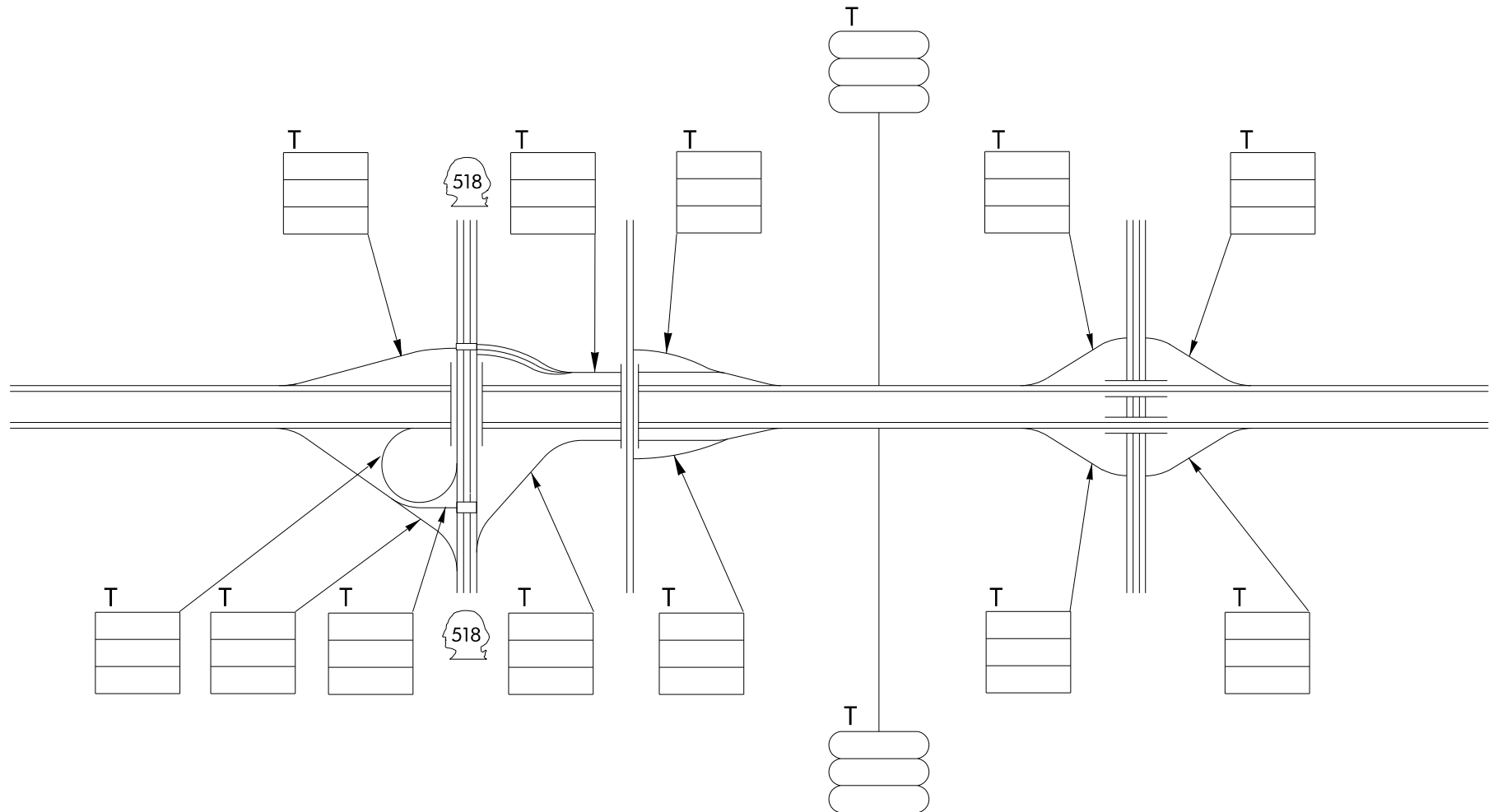

Washington State
Department of Transportation



2
OF
4

GLENDALE WAY S
5TH AVE S /S 112TH ST

1ST AVE S
S CLOVERDALE ST

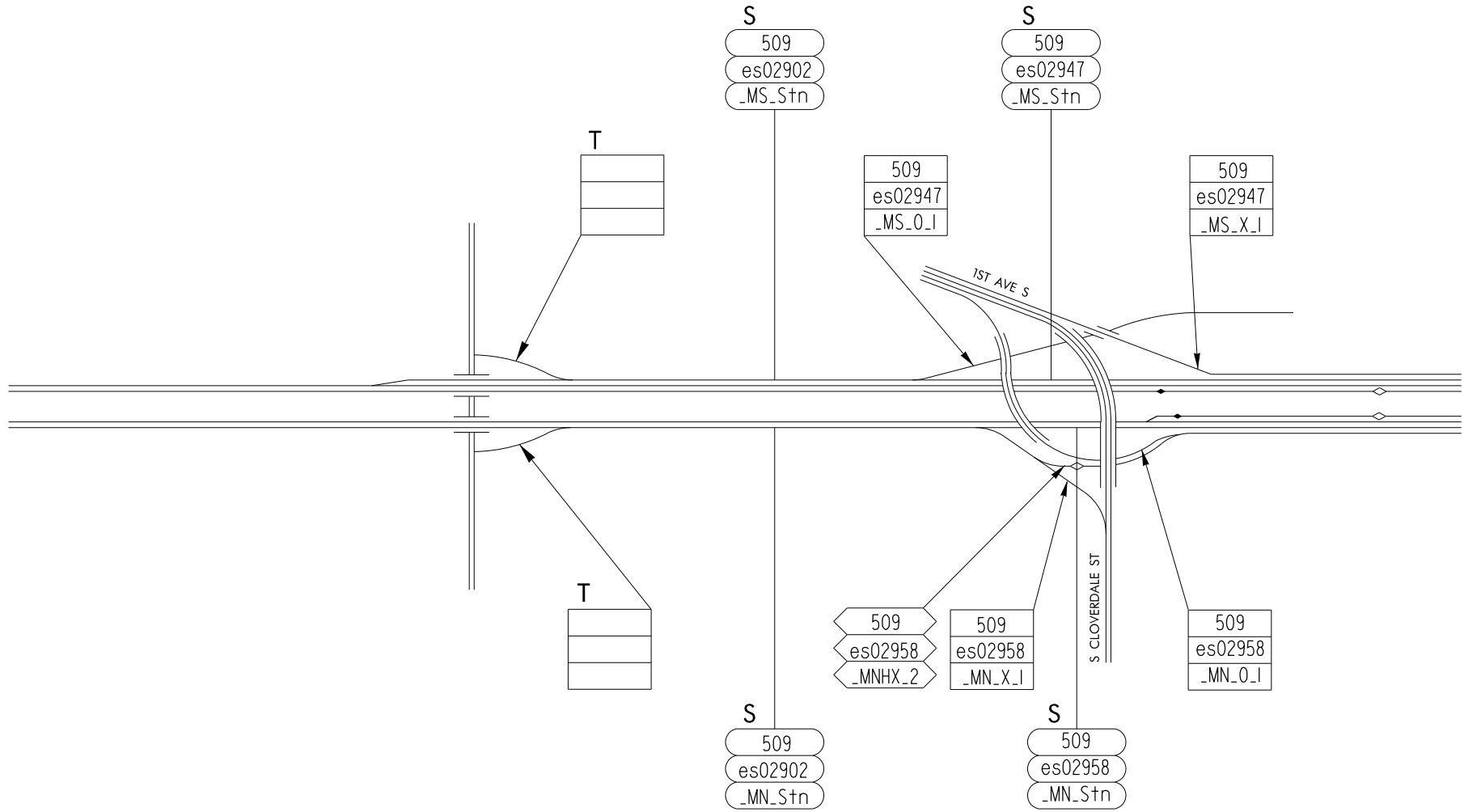

SR 509
S HOLDEN ST



1ST AVE BRIDGE S

509
es02976
.MS_Stn

509
es02976
.MSH_3

509
es02976
.MS_0_1

509
es02976
.MS_X_1



509
es02976
.MN_X_1



es02976
.MN_0_1
.MN_0_2

509
es02976
.MN_Stn

509
es02976
.MNH_3



Washington State
Department of Transportation



4
OF
4

1ST AVE S

SR 509

DES MOINES
MEMORIAL DR S

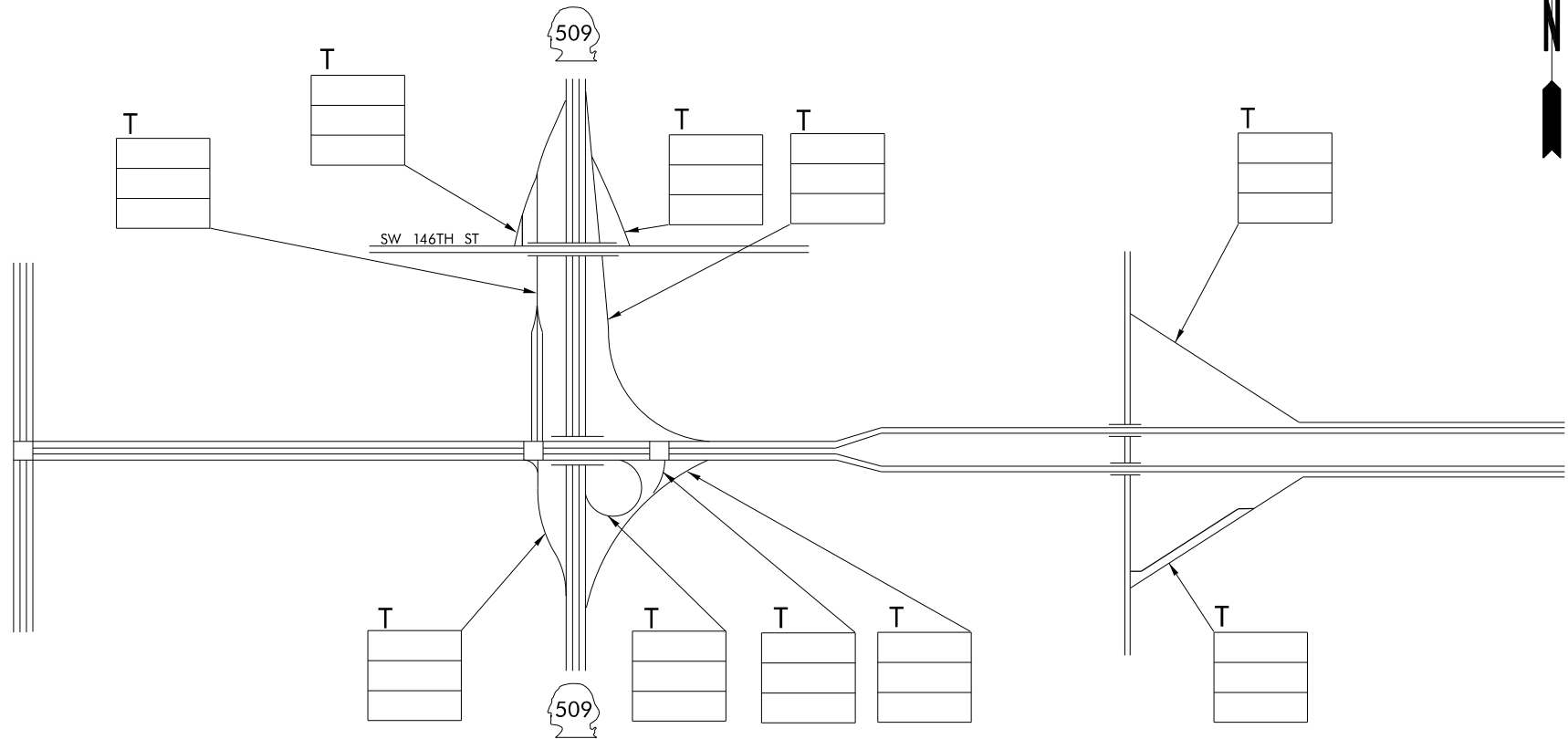

Washington State
Department of Transportation



1
OF
3

S 154TH ST

PERIMETER RD
SEA-TAC
ACCESS

SR 99
PACIFIC
HWY

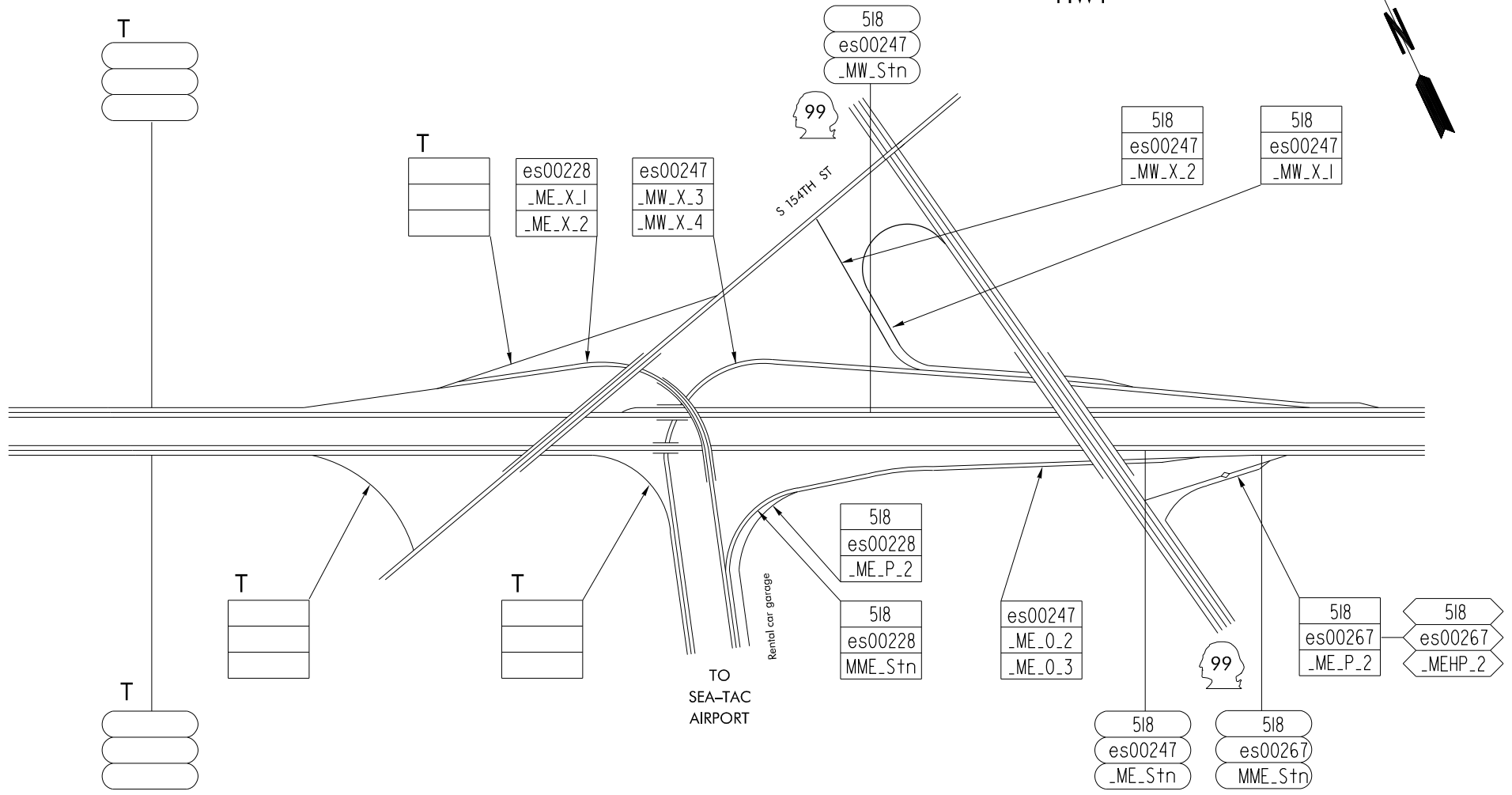
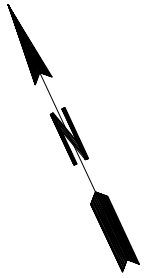

42nd AVE S

51ST AVE S

I-5



518
es00300
_MW_Stn

518
es0034I
_MW_Stn

518
es0034I
_MW_0_1

005
esI5465
_MN_0_2

005
esI5465
_MS_X_2

005
esI5465
_MS_0_1



405
es000II
_MS_Stn

405
es000II
_MS_0_1

518
es0034I
_ME_X_1



405
es000II
_MN_1_1

518
es00300
_ME_Stn

518
es0034I
_ME_Stn



Washington State
Department of Transportation



3
OF
3



I-5
E ROANOKE ST

SR 513
MONTLAKE
BLVD E

LAKE
WASHINGTON
BLVD E

EVERGREEN
POINT
FLOATING
BRIDGE

EVERGREEN
POINT RD

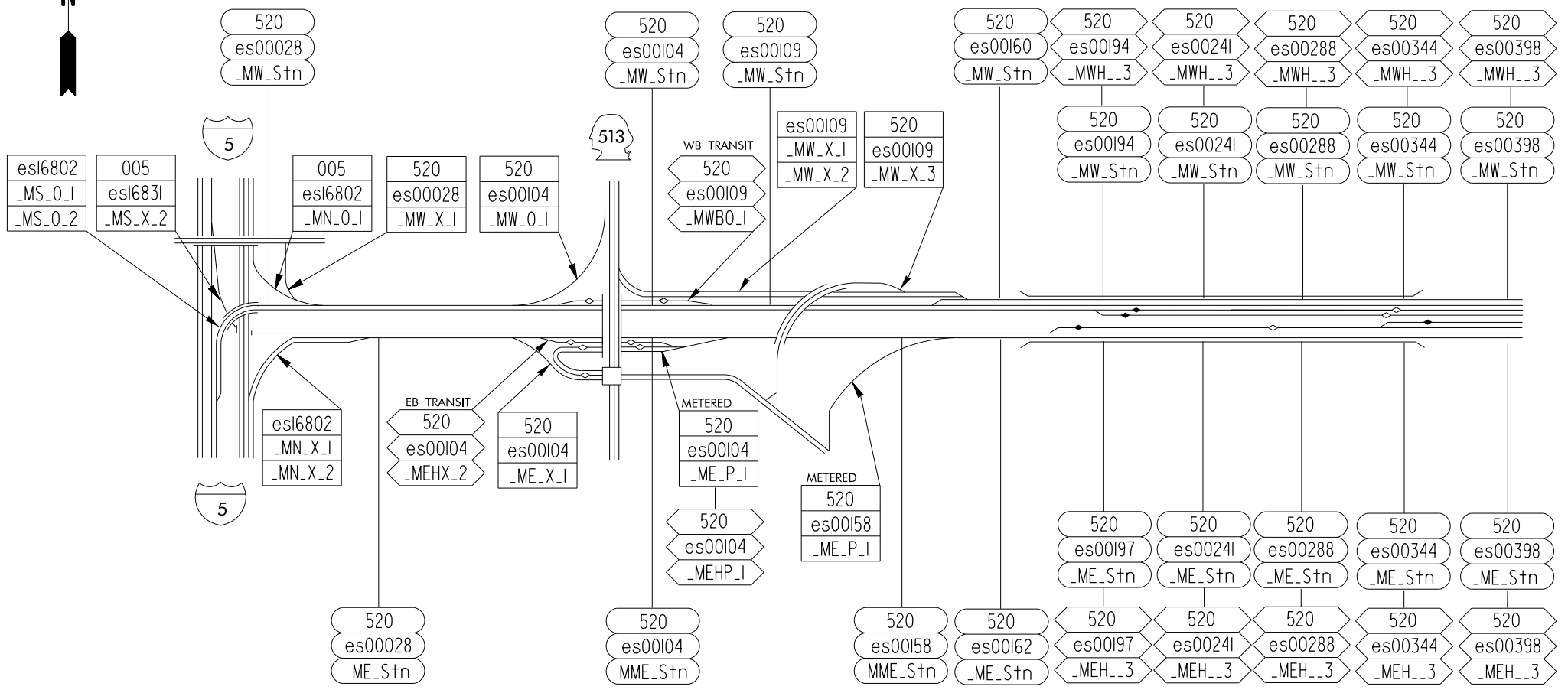

84TH AVE NE

85TH AVE NE

88TH AVE NE

91ST AVE NE

92ND AVE NE

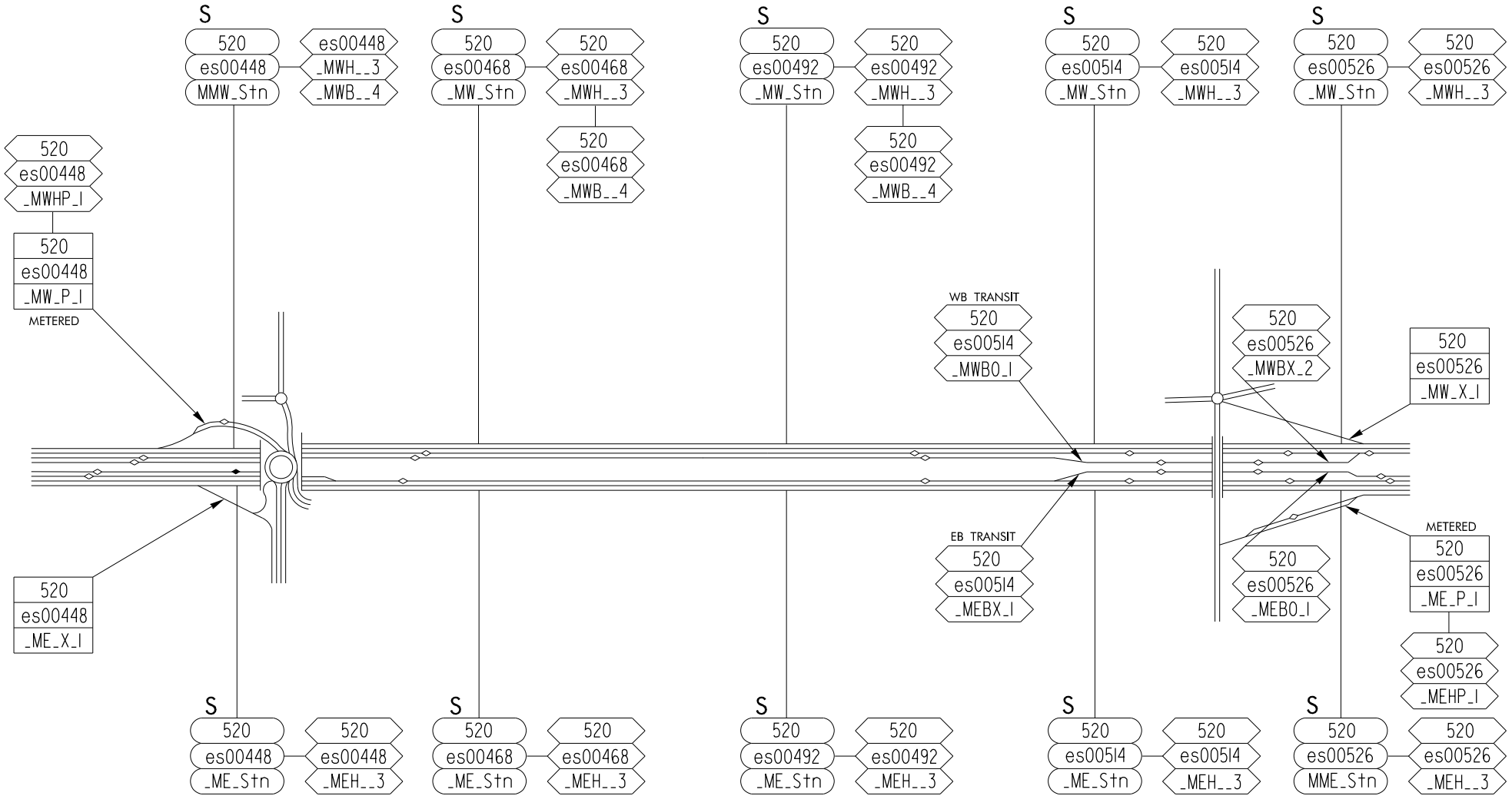

Washington State
Department of Transportation



2
OF
6

98TH AVE NE

104TH AVE NE
BELLEVUE WAY

108TH AVE NE 109TH AVE NE

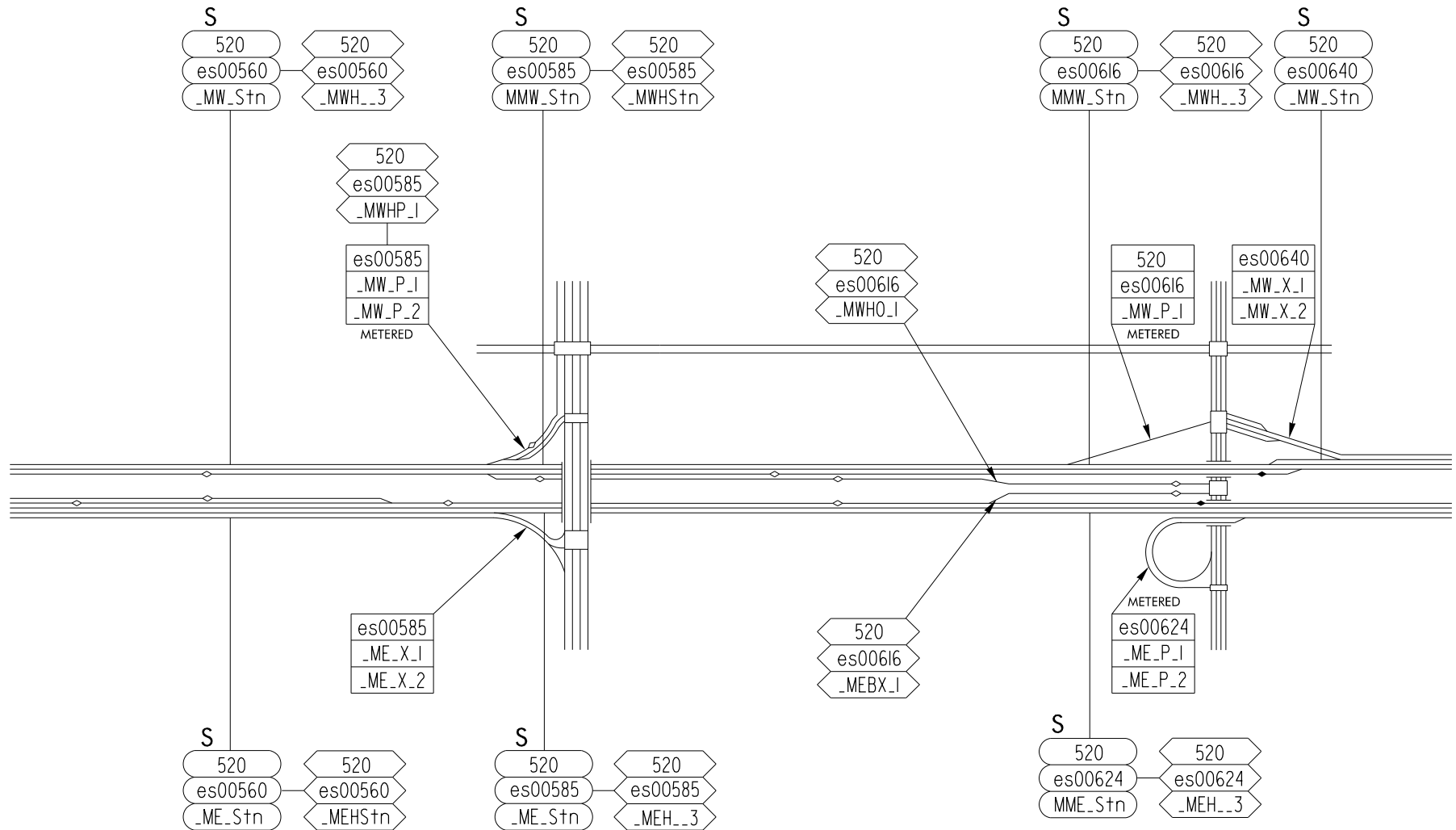

Washington State
Department of Transportation



520

3
OF
6

I-405

124TH AVE NE
NORTHUP WAY

130TH AVE NE

140TH AVE NE

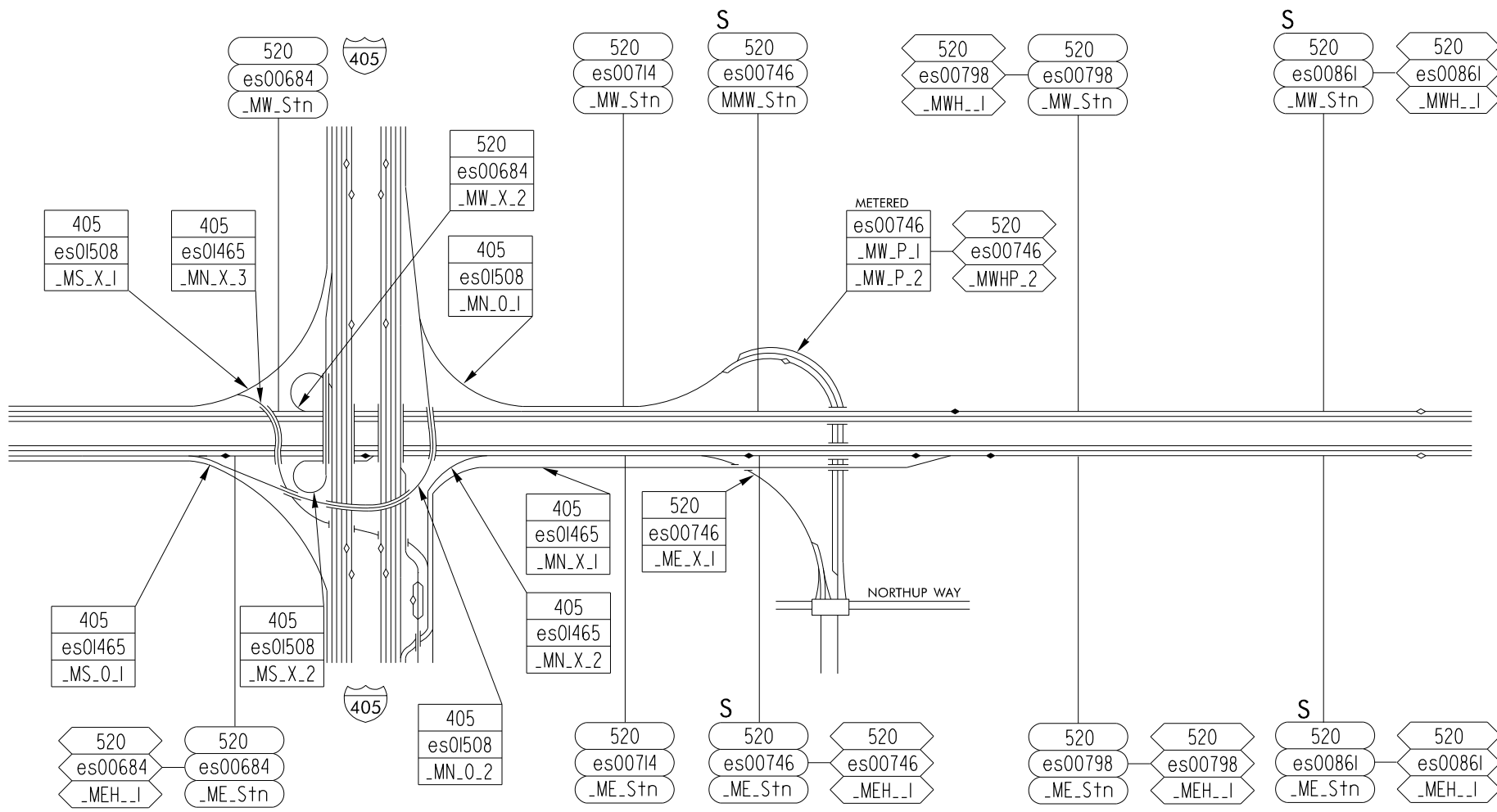

148TH AVE NE

NE 36TH ST

NE 40TH ST

NE 51ST ST



S

S

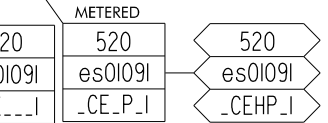
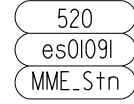
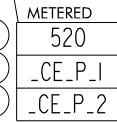
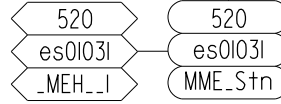
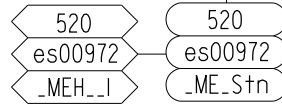
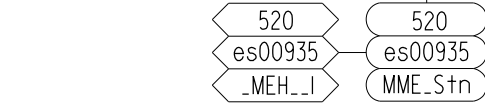
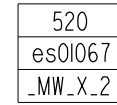
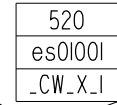
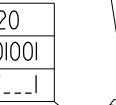
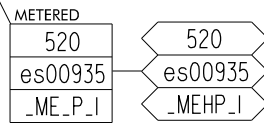
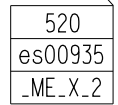
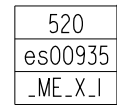
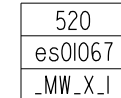
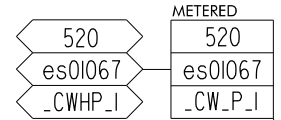
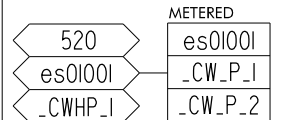
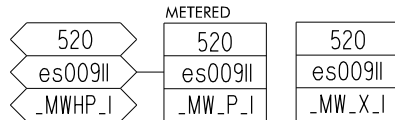
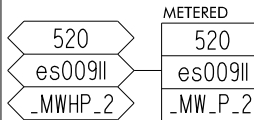
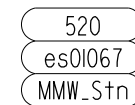
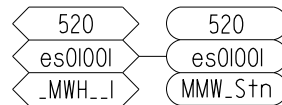
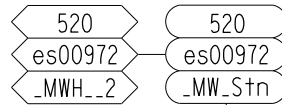
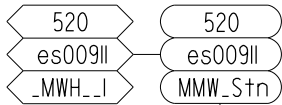

Washington State Department of Transportation



5 OF 6

NE 60TH ST

W LAKE
SAMMAMISH
PKWY NE

MARYMOOR
PARK

SR 202
REDMOND
WAY

NE 76TH ST

S
520
es01122
_MW_Stn

520
es01167
MMW_Stn

S
520
es01193
_MW_Stn

520
es01167
_MWHP_2

es01167
_MW_P_1
_MW_P_2
METERED

520
es01193
_MW_X_1

520
es01266
_MWHP_2

es01266
_MW_P_1
_MW_P_2
METERED

520
es01265
_MWHP_1

520
es01265
_MW_P_1
METERED

S
520
es01265
MMW_Stn

202

S
520
es01299
_MW_Stn

520
es01167
_ME_X_1

520
es01193
_ME_P_1

es01266
_ME_X_1
_ME_X_2

202

520
es01299
_ME_0_1

S
520
es01122
_ME_Stn

S
520
es01167
_ME_Stn

S
520
es01193
MME_Stn

S
520
es01266
_ME_Stn

S
520
es01299
_ME_Stn



Washington State
Department of Transportation



6
OF
6

I-405
(WOODINVILLE)

132ND AVE NE
SR 202

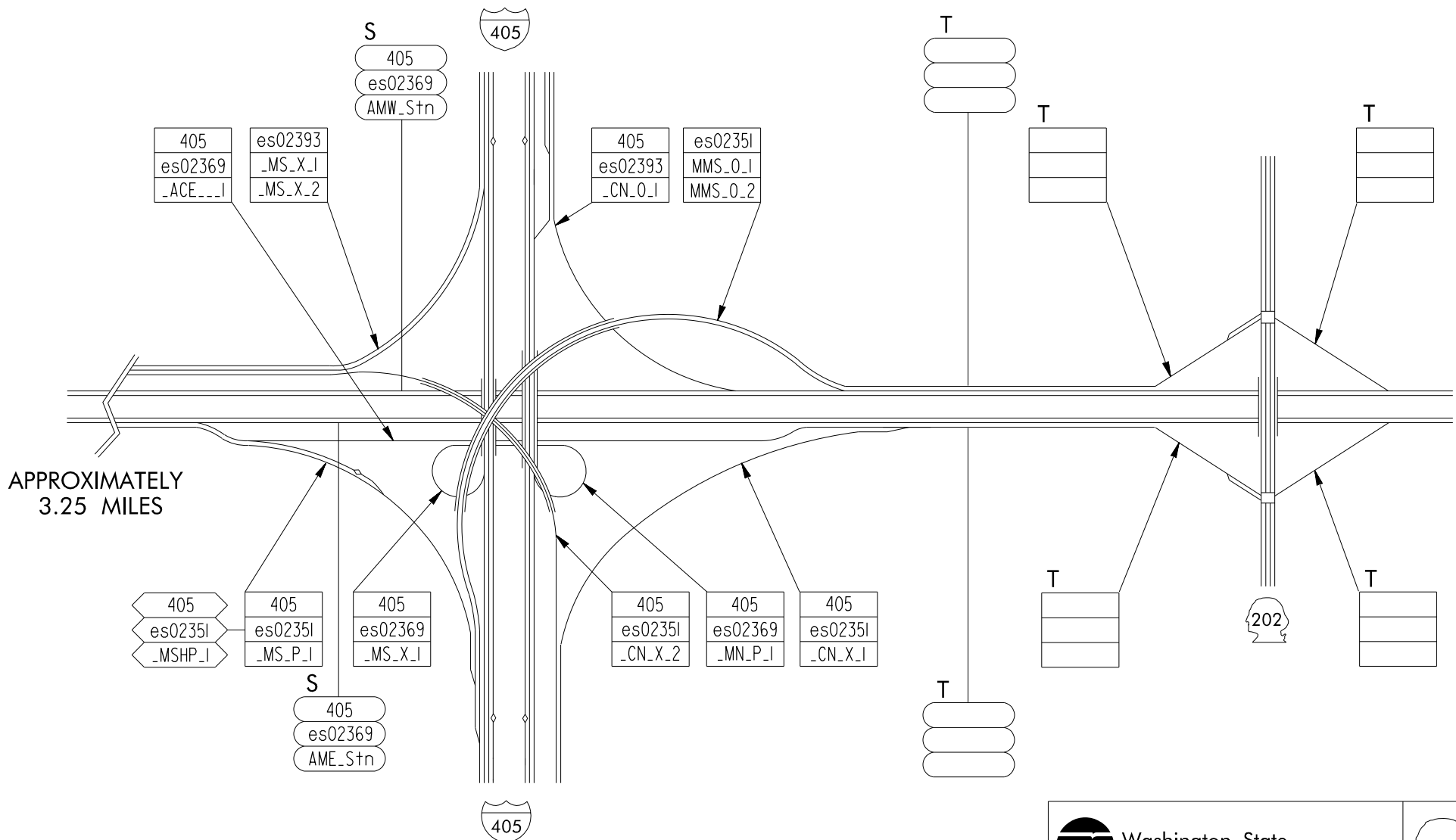

APPROXIMATELY
3.25 MILES

NE 195TH ST

SR 9
WOODINVILLE CUT-OFF

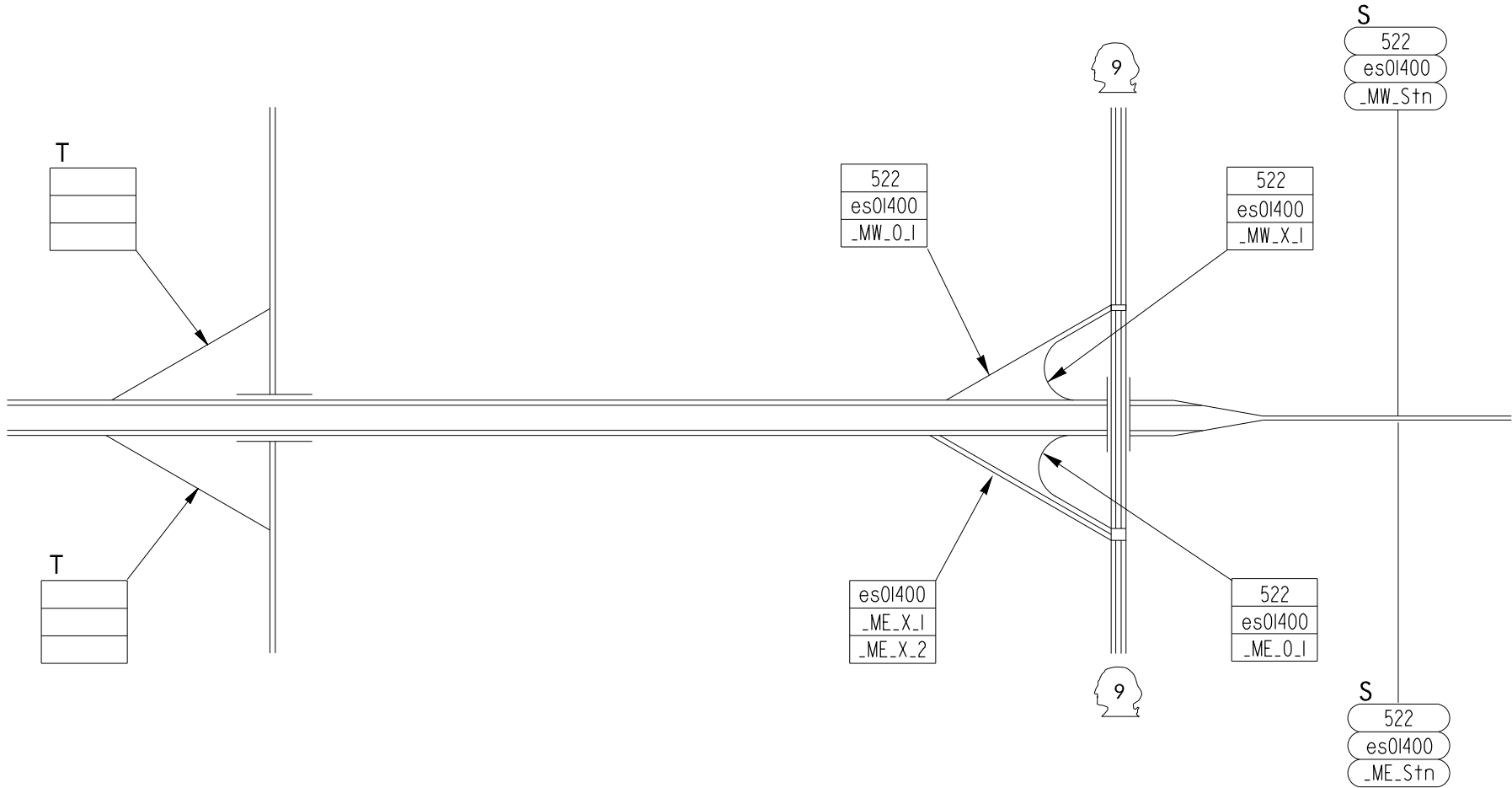

Washington State
Department of Transportation



2
OF
4

Echo Lake Rd

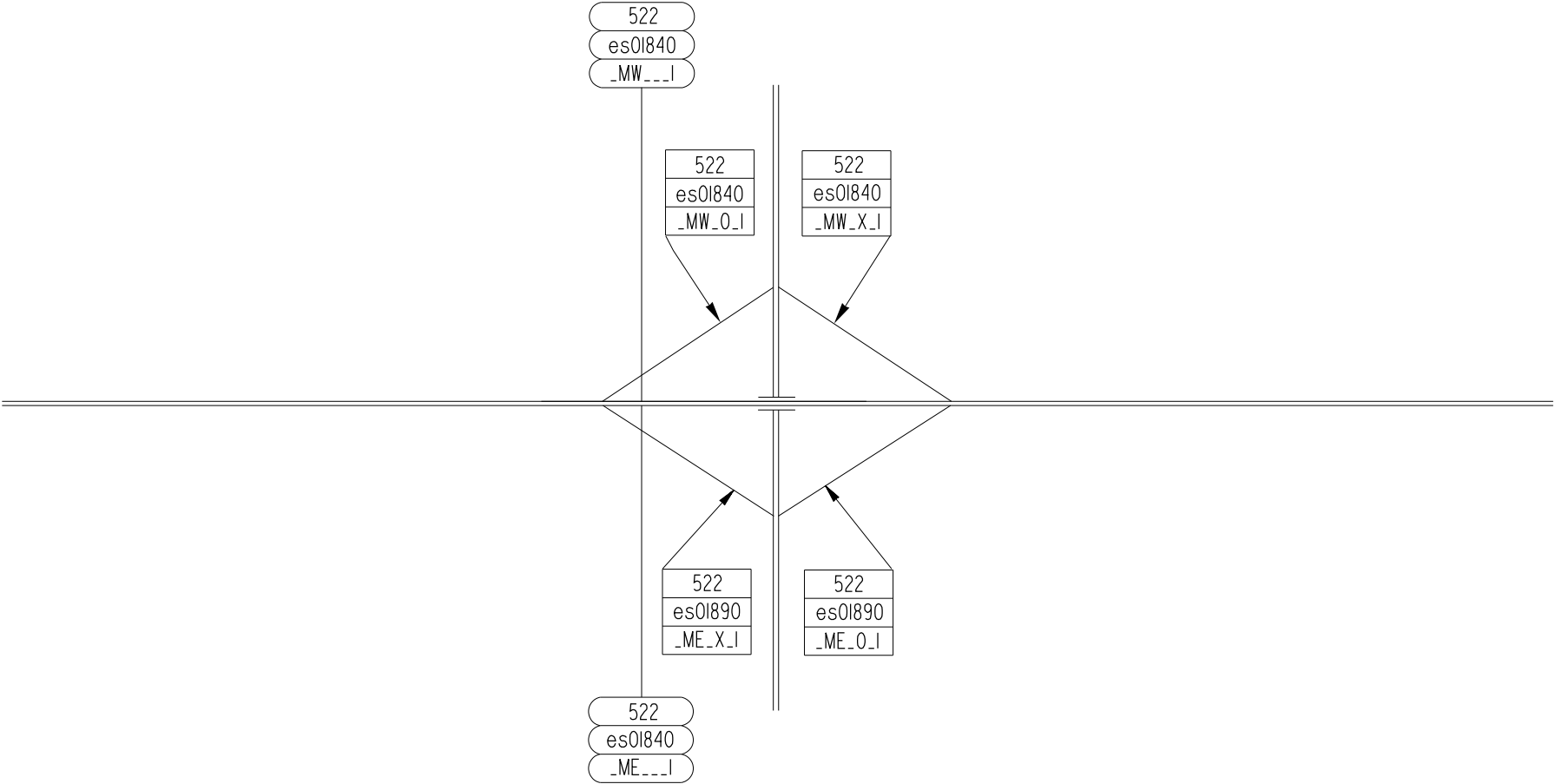

Washington State
Department of Transportation



3
OF
4

W Main St

US 2

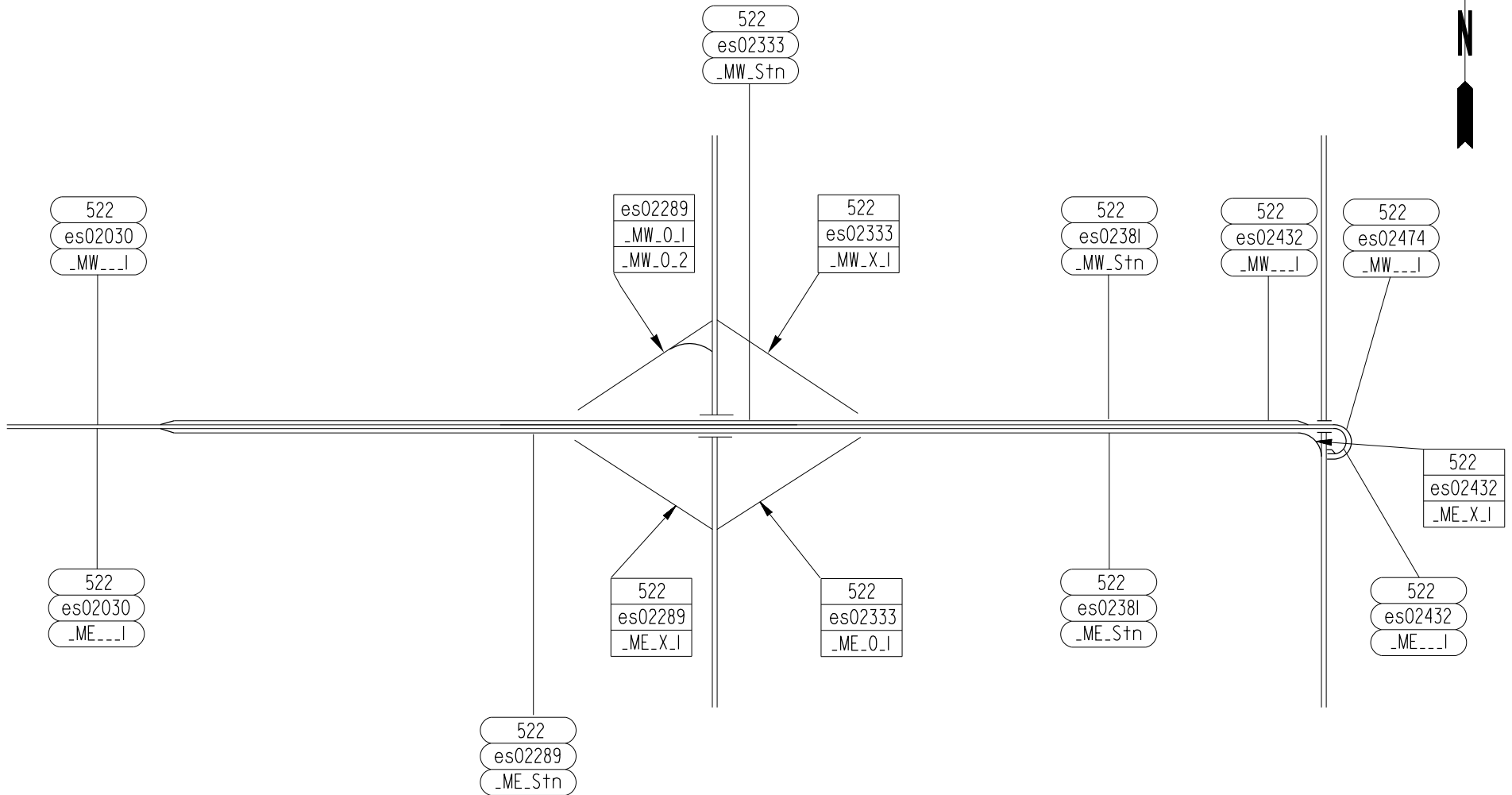

Washington State
Department of Transportation



4
OF
4



ALDERWOOD
MALL PKWY

164TH ST SW

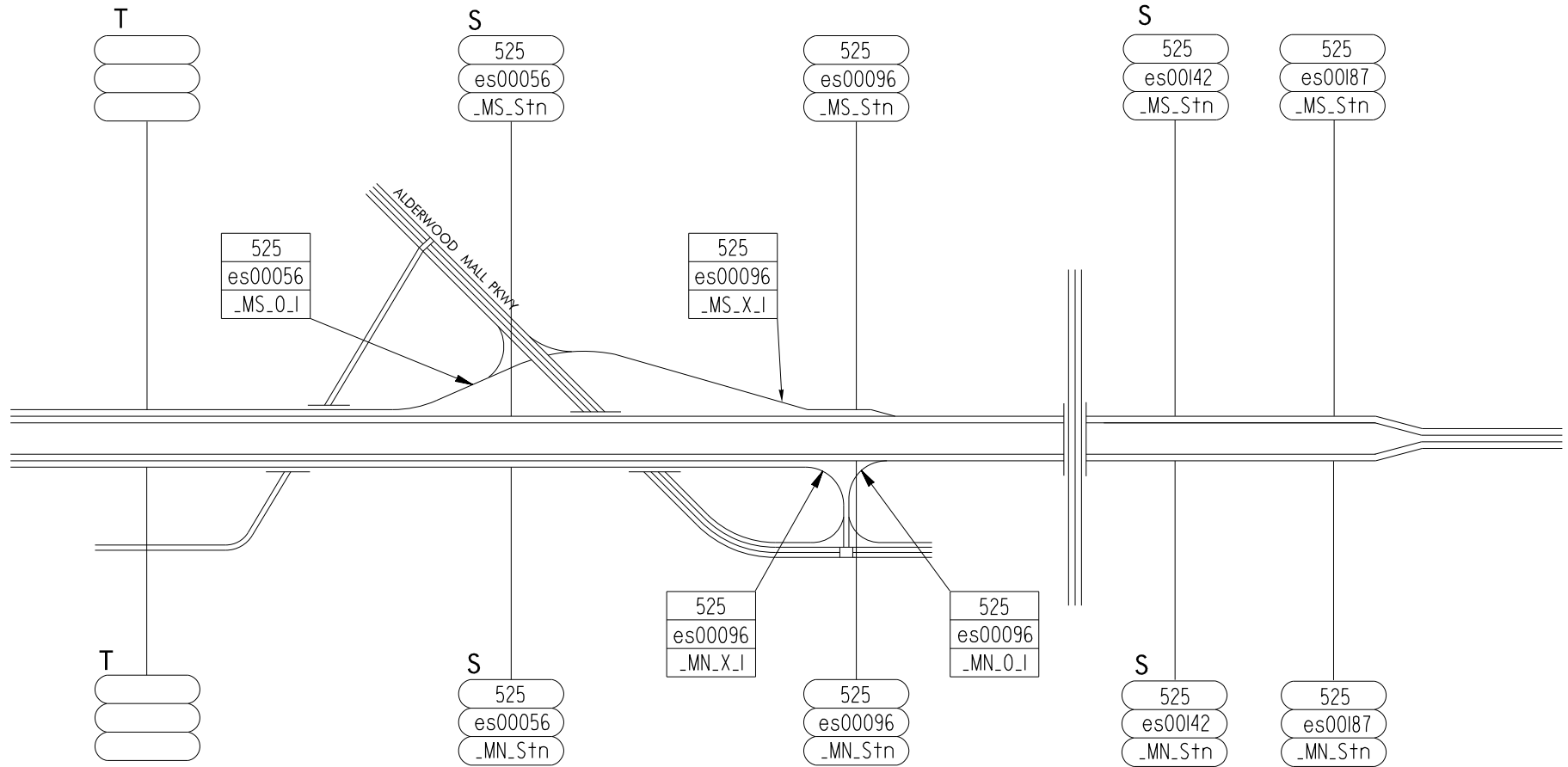

Washington State
Department of Transportation





SR 99
PACIFIC HWY

LINCOLN WAY

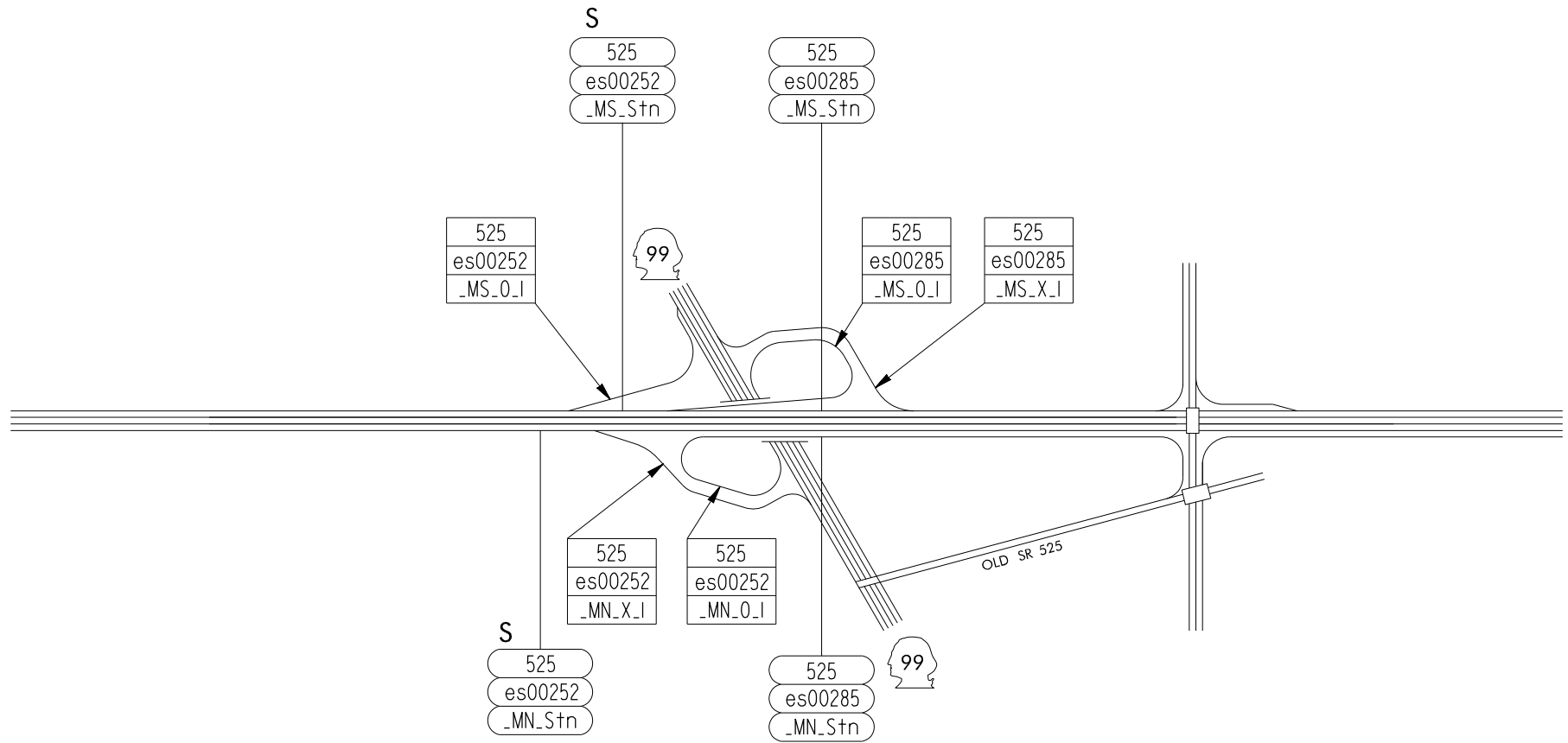

Washington State
Department of Transportation



2
OF
2

AIRPORT RD

SEAWAY BLVD
20TH AVE W

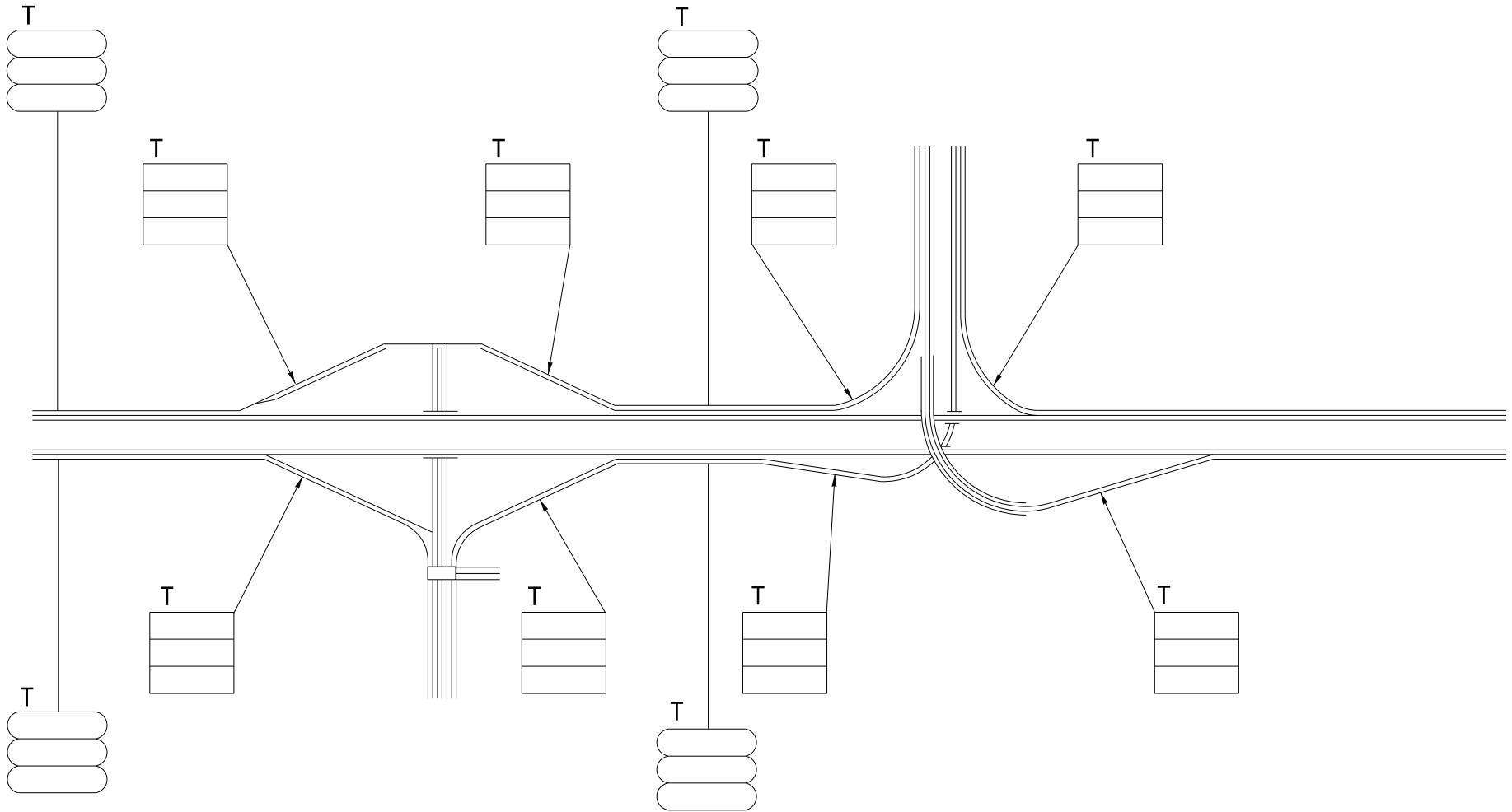

Washington State
Department of Transportation



1
OF
2

EVERGREEN WY

I-5

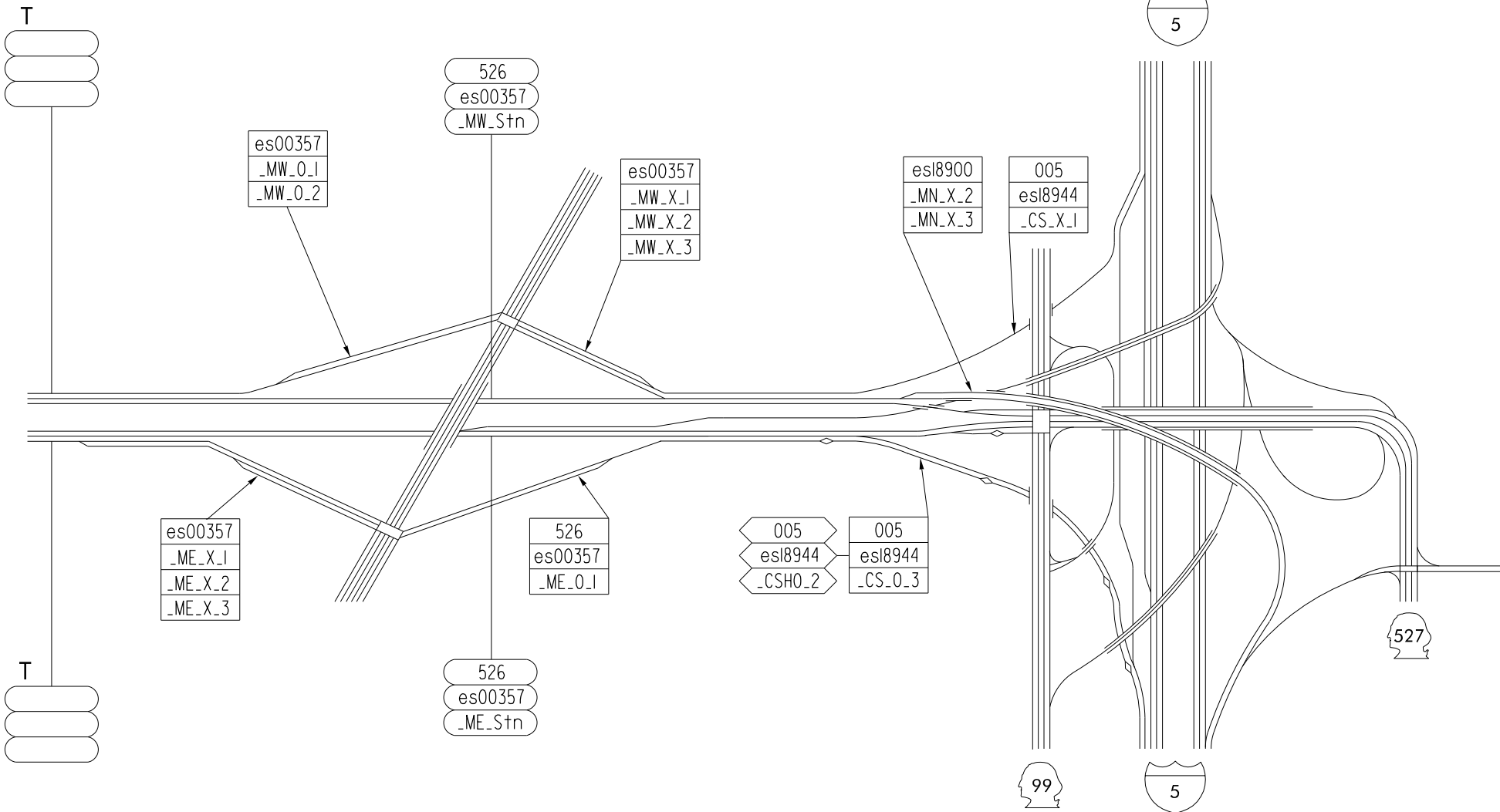

I-5

S 133RD ST

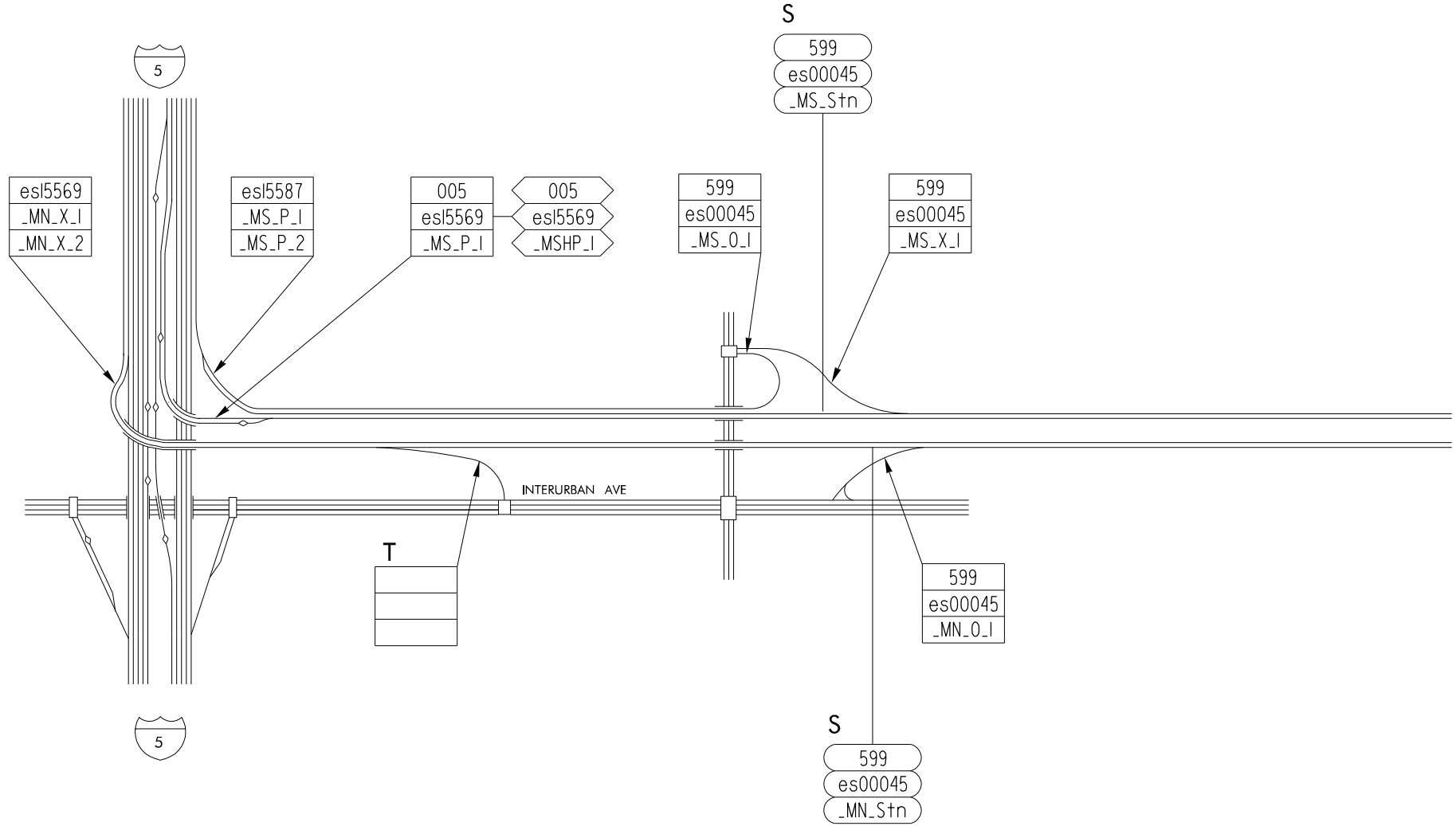
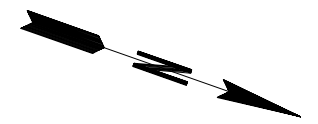

METRO BUS BARN

SR 99
TUKWILA INTERNATIONAL BLVD

